



BELDEN
SENDING ALL THE RIGHT SIGNALS

Signal Transmission Products and Systems

Master Catalog

COPPER CABLE & CONNECTIVITY

FIBER OPTIC CABLE & CONNECTIVITY

CABLE MANAGEMENT SOLUTIONS

POWER OVER ETHERNET PRODUCTS



Our New Logo and Tagline Embody Our Commitment:

We focus on being the brand you trust for any number of signal transmission solutions...the brand you can depend on for the “right” signals.

BELDEN
SENDING ALL THE RIGHT SIGNALS

Our Signal
Transmission
Solutions Exemplify
the Reliability and
Expert Care You
Have Come to
Expect from Belden

Belden: The Brand You Depend On

Over and over again our customers tell us that Belden is the brand they trust for dependable signal transmission. No matter the market – broadcast, commercial networking, security, industrial or residential – the name ‘Belden’ has become synonymous with high quality and ensured reliability.

We have earned our reputation as an expert solutions provider precisely because our customers are now, and have always been, our #1 priority.

We make it our job to consistently supply innovative, standard-setting products upon which customers can rely.

We offer the broadest selection of signal transmission products available. We provide all the data and support necessary to help you make the right decision for the intended application. And, Belden products are readily available to you, no matter where around the globe you may be.

Belden is also evolving. We are taking our success in cable to all means of signal transmission technology: copper, optical fiber and wireless. And we have expanded our product offering to include complete system solutions, including connectivity, equipment enclosures, cable raceways and racks.

Take a look at the first wave of our evolution, embodied within these pages – being mindful that even more dynamic products, systems and services are sure to come.

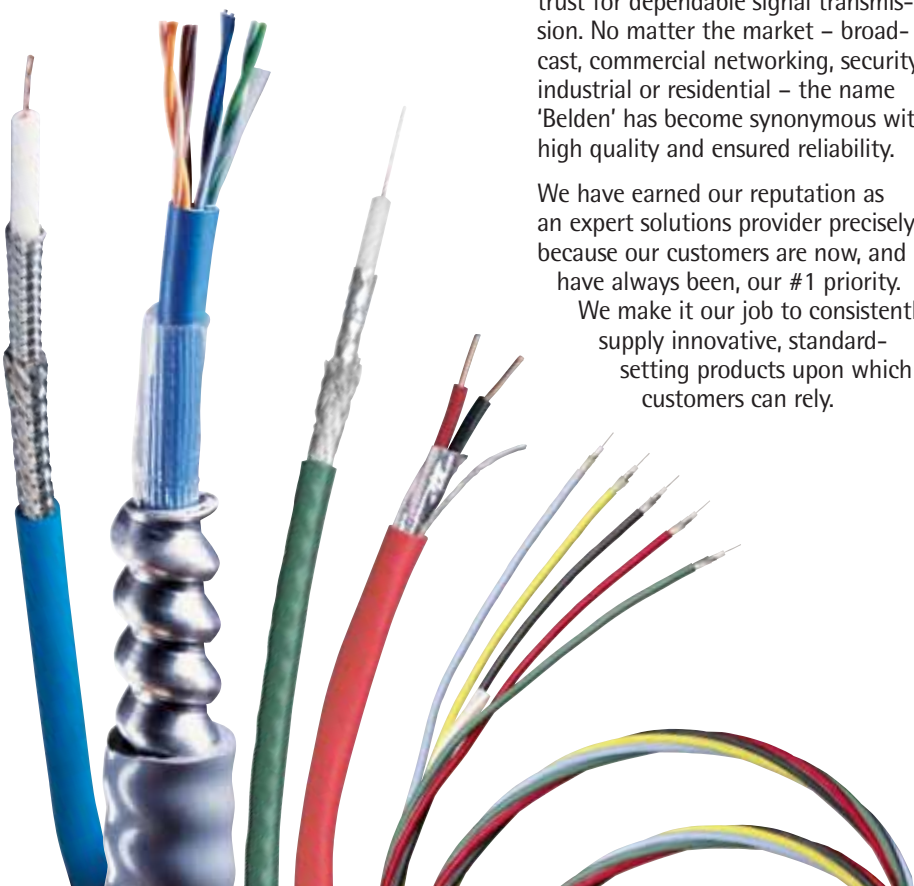



Welcome to the Most Complete Resource in the Industry for Reliable Signal Transmission Products

The Belden® Master Catalog is a uniquely distinctive publication. An unparalleled resource for cabling and related product solutions, this catalog represents Belden's commitment to providing you with the most reliable signal transmission products, whatever the application and wherever you are in the world.

We believe you will find our Master Catalog to be an essential tool for solving a wide range of application problems. In addition, all of the information contained in this catalog, along with easy-to-use search tools, is available at www.belden.com.

Environmental Compliance

The use of materials that are environmentally friendly is of growing concern to Belden, its customers and to the global community. As a result, virtually 100% of

Belden cables now meet the requirements of both the Restriction on Hazardous Substances (RoHS) Directive and California Proposition 65. This catalog has annotated only those cable products that were non-compliant at time of printing. Other Belden products in sections 11, 12, 13, 14, 15 and 16 are in the process of becoming compliant. For updates, please see the Belden Web site or contact Customer Service.



More detailed compliance information can be found in Technical Information (Section 22, page 22.23). For definitions of the various environmental regulations involved, please consult the Glossary of Terms, beginning on page 22.24.

SECTION INDEX

SECTION NAME	SECTION NO.
Table of Contents	1
Cable Finder Guide	2
Hook-Up and Lead Wire	3
Multi-Conductor Cables	4
Paired Cables	5
Coaxial Cables	6
Flat Cable	7
Molded Cable Assemblies	8
Portable Cordage	9
Optical Fiber Cables	10
Enclosures and Accessories new	11
Open Frame Racks and Accessories new	12
Surface Raceway Systems and Accessories new	13
PowerSense® PoE Products new	14
Commercial Networking - Copper new	15
Commercial Networking - Optical Fiber new	16
Commercial Networking - Training new	17
Industrial Cables	18
Brilliance® Broadcast Products	19
New Generation® Sound, Security and Alarm Cables	20
Residential Cables	21
Technical Information and Glossary	22
Part Number Index	23



We Continue to Innovate with Award-Winning Cables

Belden's cable designs have been singled out for recognition in the trade press, at a variety of trade shows and, most importantly, with our customers. A few are represented here.

Banana Peel: Transforming Composite Cable Installation

Chief among these offerings is an entirely new concept in composite cable design called Banana Peel. Belden® patented Banana Peel cables* are an installer's dream, offering an easy-to-install, fully integrated version of a composite cable construction where the various cables are not just bundled together but affixed to a center spline for easy pulling.



But there's more – Belden has gone one step further in installation ease by completely eliminating the overall jacket. Without this jacket, a whole step in the installation process is eliminated, plus the individual cable components are all instantly identifiable and ready for termination. Installers can now pull of a variety of cables at once, then simply peel the individual cables off the center spline and terminate them. It's that easy.

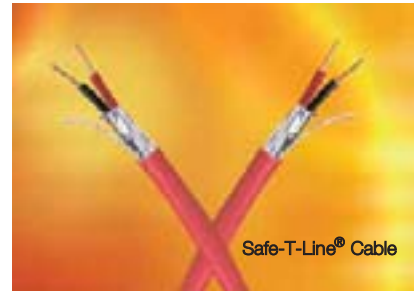

A Whole New Level of Security: Belden Safe-T-Line® Cables

Another recent award-winning cable is Belden's Safe-T-Line Circuit Integrity cable – a cable that allows the EVAC systems in high-rise office buildings to remain operational for two hours in the event of a fire or other emergency. This allows the building occupants an opportunity to hear either live or recorded voice instructions that will guide them out of the building in a timely and orderly way. Reliability of this kind takes design integrity – something that our customers define as a core Belden competency.

DigiTruck: An Extremely Small Cable with Big Performance

Award-winning DigiTruck is a revolutionary new cable with superior return loss characteristics that has been designed specifically for analog, SDI, HD video and AES/EBU digital audio transmission in broadcast production trucks. DigiTruck is a miniature coaxial cable, weighing just 7.25 lbs per 1,000 feet, or about 60% less than a standard Mini RG 59/U coax. It also requires approximately 40% less space. Only Belden could devise such an innovative and efficient solution to meet the broadcast needs of today's weight-challenged and space-cramped mobile television trucks.

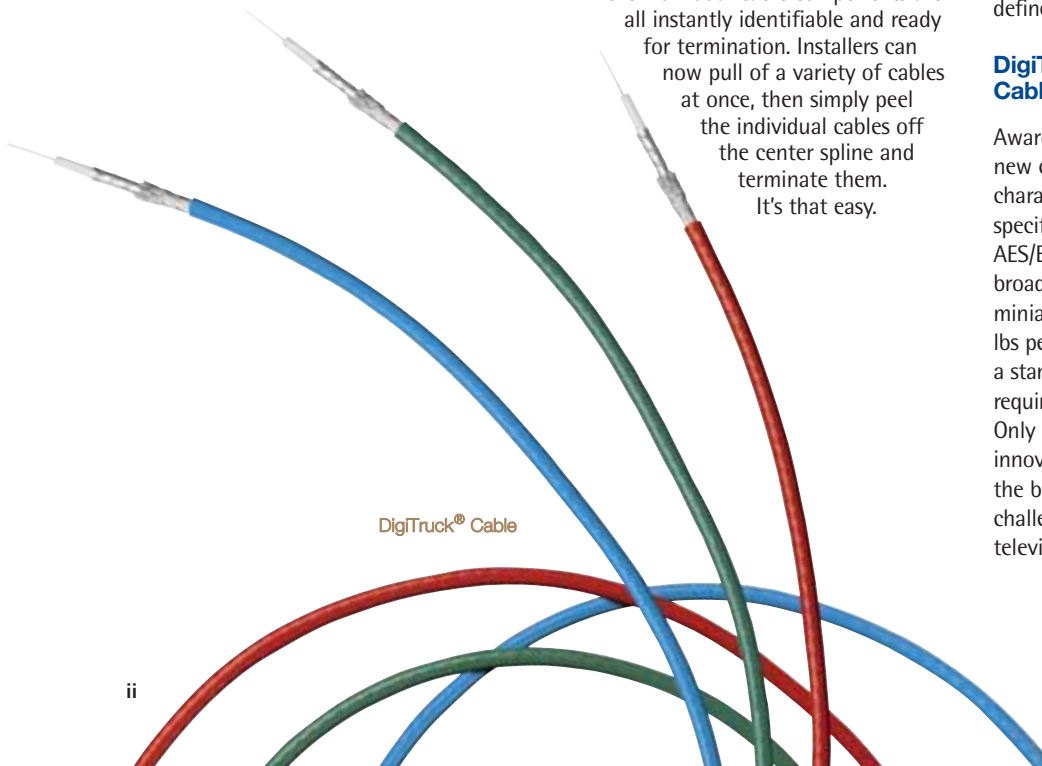



Premier Structured Cabling Systems – Both Copper and Fiber – Are Now Part of the Belden® Line-Up

Our full range of Belden IBDN® copper and fiber structured cabling products *and* systems can be found in the Commercial Networking sections (Sections 15, 16 and 17), where you'll also find a full complement of training programs for Belden IBDN.

All Belden IBDN networking system components are engineered to exacting specifications and manufactured under the most stringent quality controls. The components used in our Belden IBDN Systems – including backbone cables, cross-connect hardware, cross-connect patch wires and cords, and horizontal cables – have been specifically designed to work together as an integrated system. To complete the installation, our product offering also includes a variety of outlets, connector modules, faceplates, adapters and modular cords.

Our flagship system, **Belden IBDN System 10GX®**, is revolutionary not only in its expression as a fully integrated 10 Gigabit structured cabling solution, but in the way it has been designed around a series of dynamic enabling technologies. These technologies help solve the two major performance issues that plague most other manufacturers, yet they are instrumental to 10 Gigabit transmissions: the ability to significantly reduce Alien Crosstalk and the control of key electrical characteristics during high frequency operation.

System 10GX and other Belden IBDN structured cabling systems have been widely installed around the world. Their ubiquity is testimony to the proven success of these systems.

Our structured cabling systems are comprised of top-of-the-line system components – all quality-built to our exacting specifications

Other top-performing structured cabling systems in the Belden IBDN mix include:

- The 1.2 Gb/s Category 5e
Belden IBDN System 1200
- The 2.4 Gb/s Category 6
Belden IBDN System 2400
- The 4.8 Gb/s Beyond Cat6
Belden IBDN System 4800LX

On the optical fiber side of the structured cabling systems business, we offer Belden IBDN FiberExpress. The FiberExpress Solution is a complete end-to-end optical cabling system supporting both centralized and fiber-to-the-desk topologies, as well as backbone and campus cabling configurations.

For the ultimate in quick, easy and reliable optical networking, we also offer the FiberExpress Pre-connectorized System. These products are “plug and go” and their deployment requires no specialized tools, so you can deploy 12 fibers in the same amount of time it takes to connect a power cord to a standard electrical plug!

All Belden IBDN Systems Are Fully Certified

To be 'Certified' each Belden IBDN system must be designed and installed by a factory-trained Certified System Vendor (CSV), plus the system must be composed of all Belden IBDN components. A 25-year Product Warranty and a Lifetime Application Assurance program accompany each Belden IBDN 'Certified' System installation, including coverage for both parts and labor.

Our Customer Training Programs Are an Industry Standard

To facilitate our customers' understanding of structured cabling – and in order to keep both our customers and our CSVs current with new technologies, techniques and industry standards – we offer the Belden IBDN Training Center. With classes taught by a highly credentialed staff with over 100 years of cumulative experience in structured cabling, this Center serves the needs of more than 5,000 individuals each year.



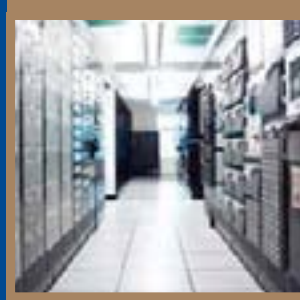

An All-New, Comprehensive Line of Cable Management Solutions

New This Year Are Belden's Enclosure and Open Frame Rack Solutions



Enclosures and
open frame rack solutions

A full complement of products – including numerous mounting, cable and patch cord management options and accessories – have been designed to meet the unique needs of data centers, as well as various networks and control systems. Whether it's the protection of sensitive equipment, or the ability to mount equipment of varied sizes and depths, Belden has the solution you need.

A Masterful PoE System Becomes Part of Our Systems Offering

Ensuring Reliable Delivery of Power Over Ethernet (PoE)

We now offer the Belden PowerSense® system, a cutting-edge, modular approach to the distribution of wireless signals. Our system products include PowerSense Midspan Hubs, any combination of discrete power modules, connectors and Y cables. With PowerSense, it's easy to scale up when devices need to be appended to the system because new modules can be added to our hubs as they are required.



PowerSense® System

We've Even Added Cable Ties and a Surface Raceway System

To help get organized and neatly route installed cable, we also offer a wide variety of cable ties in standard nylon, weather-resistant nylon, or Velcro® to suit varying load capacities.

Another addition, the Belden® Surface Raceway System, is a functional, affordable and attractive solution for wire enclosure applications. This product line includes extruded raceways with pre-applied adhesive backings, a variety of fittings and junction boxes.





Table of Contents

Visit our Web Site

Our Web site is a valuable online resource for Belden wire and cable products, services, support, solutions, and purchasing information. Point your browser to www.belden.com to find out more.

Contact One of Our Sales Representatives for Assistance

Call 1-800-BELDEN-1 in the U.S. or 1-765-983-5200 outside the U.S. You can also fax us at 1-765-983-5656 or email us at techsupport@belden.com.

To Place an Order

For many of the products in the catalog, you will find everything you need in this catalog to place an order. Should you need assistance, please contact your Belden sales representative. A complete list of all of our sales offices can be found on the back cover of this catalog or at www.belden.com.

How to Use the Belden® Master Catalog

If You're Not Sure Of What You Need...

Select By Cable Type or Application

Use the Section Index below or look at the more detailed Table of Contents pages found at the beginning of *each* section to find your cable type or application.

Select By Keyword

Reference the *Table of Contents* section on the following pages for an alphabetical listing of product keywords.

Consult the Cable Finder Guide

If you know the gage size, shielding type, and/or number of conductors needed for your application, you can locate a part number and corresponding catalog page number for all matching multi-conductor and paired cable products in the *Cable Finder Guide* (Section 2).

If You Know The Belden Part Number...

Consult the Index in the Back of the Catalog

In the *Part Number Index* (Section 23), you'll find a numerical listing of Belden part numbers. This comprehensive Index lists every product featured in the *Belden Master Catalog*.

Section Index

Section Name	Section No.
Table of Contents	1
Cable Finder Guide	2
Hook-Up and Lead Wire	3
Multi-Conductor Cables	4
Paired Cables	5
Coaxial Cables	6
Flat Cable	7
Molded Cable Assemblies	8
Portable Cordage	9
Optical Fiber Cables	10
Enclosures and Accessories new	11
Open Frame Racks and Accessories new	12
Surface Raceway Systems new	13
PowerSense® PoE Products new	14
Commercial Networking – Copper new	15
Commercial Networking – Optical Fiber new	16
Commercial Networking – Training new	17
Industrial Automation and Control Cables	18
Brilliance® Broadcast Cables	19
New Generation® Sound, Security and Alarm Cables	20
Residential Cables	21
Technical Information & Glossary	22
Part Number Index	23

Table of Contents

Alphabetical Index

Products	
10GX® , Belden IBDN® System	15.2–15.8
110 Cross-Connect System	15.18–15.20
ACIC Cable (CSA)	
330V	18.80–18.81
600V	18.83, 18.88
Access Control Cable	20.35–20.36
AES/EBU Digital Audio Cable	19.26–19.30 21.24
AES-3id Cable	6.40–6.44 19.49–19.56
Alarm & Security Cable	4.32–4.34 20.1–20.72 21.24
Aluminum Ground Wire	3.27
Amateur Radio Cable	6.91
Analog Audio Cable	19.9–19.25 21.24
Antenna Coax	6.59–6.71 6.76–6.78
Antenna Wire	3.27
Antenna Rotor Cable	4.8
Armored Cable	18.10–18.11 18.16, 18.19 18.28, 18.41 18.71–18.76 18.80–18.81, 18.83 18.88–18.94
Armoring Capabilities	22.14
Assemblies	
Copper Cable (Networking)	15.41–15.43
Optical Fiber	16.6–16.8
Audio, Communication & Instrumentation Cable, Special	5.46–5.47 6.82 19.38–19.40
Audio Wire & Cable	
Brilliance® Broadcast	19.9–19.40
Coaxial	6.82
Multi-Conductor	4.3–4.7 4.12–4.14 4.20
New Generation® Commercial Audio	20.67–20.72
Paired	5.4–5.9 5.16–5.24 5.35–5.48 5.51, 5.54
Residential	21.3–21.11 21.20–21.24
Augmented Category 6	15.6–15.8
Automation	
Factory	(See Industrial Section)
Home	(See Residential Section)
Backbone Cable	
Copper	15.46–15.82
Optical Fiber	16.19–16.34
Banana Peel® Composite Cable	
Access Control	20.35–20.36
Broadcast Component Video	19.72–19.73
CCTV Cable for Pan/Tilt/Zoom	20.42–20.47
DataTwist® 350	15.55
Residential	21.3–21.4 21.17–21.18
Belden IBDN® System 10GX® Structured Cabling	15.2–15.8
Belden Infinity® Cable	18.31–18.40
Belflex® Portable Cordage	9.4–9.5, 9.8

Products (continued)	
BIX Cross-Connect System	15.13–15.17
Blue Hose® Cable	18.14–18.16
Bonded Pairs	15.41, 15.46, 15.48 15.50, 15.53, 15.55
Bonding Cable	3.26
Breakout Style Optical Cable	10.6–10.7
Brilliance® Audio Cable	19.9–19.40 21.3–21.8 21.24
Brilliance Cable	(see Broadcast Cable)
Brilliance VideoFLEX® Cable	6.45–6.46 19.55
Brilliance VideoTwist® UTP Cable	19.74–19.75
Broadband Cable	6.16–6.30
Commercial Networking	15.77–15.78
Residential	21.12–21.13
Broadcast Cable	19.1–19.78
75 Ohm Standard Analog Video Coax	19.41–19.48
AES/EBU Digital Audio Cable	19.26–19.30
Analog Multi-Pair Snake Cable	19.16–19.25
Audio/Video & Composite Camera Cable	19.63–19.68
Banana Peel® Cable	19.72–19.73
Bundled Analog/Digital Coax	19.55–19.56
DigiTruck™ Mini Coax	19.50
Line-Level Analog Audio Cable	19.9–19.15
Low-Loss Serial Digital Coax	19.54
Microphone & Musical Instrument Cable	19.3–19.8
Precision Video Coax for Analog & Digital	19.49–19.58
RGB Component Video Cable	19.69–19.73
Residential	21.14–21.19
RJ-45 Cable for A/V Applications	19.74–19.76
S-Video Cable	19.77
Shipboard Audio/Video Cable	19.10, 19.12 19.76
Snake Cable	19.16–19.25 19.28
Speaker Wire and Cable	19.31–19.36
Special Audio, Communication & Instrumentation Cable	19.38–19.40
Standard Analog Video Coax	19.41–19.48
Technical Information	19.78
Video Triax Cable	19.59–19.62
Wi-Fi Tower Cable	19.76
Burglar Alarm Cable	20.8–20.27 21.24
Burial Cable	(see Direct Burial Cable)
Bus Bar Wire	3.27
Cabinets, Enclosures & Accessories	11.1–11.29
Cable Management Products	
Cable Ties	12.8–12.10
Modular Enclosures & Accessories	11.2–11.27
Open Frame Racks & Accessories	12.1–12.7
Surface Raceway Systems	13.1–13.3
Wall Mount Enclosures & Accessories	11.28–11.29
Cable Raceways	13.1–13.3
Cable Standards Reference Guide	22.20
Cable Ties	12.8–12.10
California Proposition 65 Regulations	22.23
Camera Cable	19.63–19.68
Canadian Electrical Code (CEC) Reference Information	22.20, 22.22
CANopen Cable	18.28

Products (continued)	
Category 3 Cables	15.63–15.66
Category 5 Cables	15.59–15.62 15.68–15.69
Category 5e Cables	15.50–15.51 15.55–15.58 15.67, 15.71, 15.73
Category 6 Cables	15.46–15.49 15.52–15.53 15.70, 15.72
Category 6 Connectivity	15.9–15.12 15.22, 15.25, 15.41
CatSnake™ Cat 5e Audio/Video Cable	19.76
CB Cable	6.91
CCTV Cable	19.41–19.48 20.37–20.54 21.25
Central Office Cable	6.55–6.58
CI Cable	20.63–20.64
CIC Cable (CSA)	
300V	18.78–18.79
600V	18.82, 18.84–18.86
Circuit Integrity (CI) Safe-T-Line® Cable	20.63–20.64
Circuit Integrity in Conduit (CIC) Safe-T-Line Cable	20.61–20.62
Closed Circuit TV (CCTV)	19.41–19.48 20.37–20.54 21.25
Coaxial Cable	
Coaxial and Triaxial RG Reference Guide	6.3–6.15
50 Ohm Transmission Cable	6.59–6.71
Aerial Coaxial Cable	6.17, 6.19–6.24 6.26–6.28 6.32–6.33
Amateur Radio & CB Coax Cable Assemblies	6.91
Analog Video Cable	6.34–6.39 19.41–19.48
Brilliance VideoFLEX® Cable	6.45–6.46
Broadband: CATV	6.17–6.28
Broadband: Coaxial Cable	6.16–6.30
Broadband: Headend/Video Cable	6.29–6.30
Broadband: MATV	6.16, 6.38
Broadcast Coaxial Cable	19.38 19.40–19.46
Bundled RGB	6.47–6.49 19.69–19.73
Burial Coaxial Cable	6.19–6.23 6.25–6.28 6.31, 6.33 6.85, 6.87
CATV Coaxial Cable	6.17–6.28
Central Office Cable	6.55–6.58
Computer & Instrumentation Cable	6.83–6.90
Conformable® Coax	6.72–6.75
DBS (Direct Broadcast Satellite)	6.31–6.33 21.12
Digital Video Cable	6.40–6.44
DS-3 & DS-4 Interconnect & Cross-connect Cable	6.55–6.58
HDTV Coax	6.33
HDTV/SDI Digital Video	6.40, 6.42 6.44–6.46
Headend/Video Cables	6.29–6.30
High-Flex Coax	6.30, 6.35 6.42–6.43 6.47, 6.51 6.53, 6.70



Table of Contents

Alphabetical Index

Products (continued)	
Coaxial Cable (continued)	
High-Flex S-Video (Y/C)	6.50
Industrial Coax	18.19–18.20 18.40
Industrial Twinax	18.14–18.18
Instrumentation Coax	15.40–15.61
KU Band Cable	6.31–6.33 21.12
Local Area Network (LAN) Coax	15.74 15.77–15.78
Low Loss RG-8/U Type	6.70
Low Loss 50 Ohm Wireless RF Transmission Cable	6.59–6.66
Low Noise Audio Coaxial Cable	6.82
LSZH and ABS Type Approved	6.19, 6.44
MIL-C-17G QPL Cable	6.76–6.81
Microwave Cable	6.72–6.73
Miniature Coaxial Cable	6.34, 6.45 6.47, 6.49 6.82
Plenum-Rated Coax	6.17–6.20 6.24–6.26 6.28, 6.31 6.34–6.36 6.38–6.39 6.42–6.44, 6.46 6.48–6.51, 6.53 6.55–6.57 6.68 6.70, 6.77 6.83–6.88
Precision Video Coax for Analog & Digital	6.40–6.44
RF & Wireless Coax	6.59–6.66
RG Coaxial & Triaxial Reference Guide	6.3–6.15
RGB Coax	6.47–6.49 19.69–19.73
Satellite, Direct Broadcast Cable	6.31–6.33 21.12
Security	20.48–20.50
Siamese Cable	6.19 6.32–6.33, 6.39 6.55, 6.57 6.84
Snake Cable	6.45–6.46
Special Audio, Communication & Instrumentation Cable	6.82 19.38–19.40
Standard Analog Video Coax	6.34–6.39 19.41–19.48
SVHS	19.77
S-Video	19.77
Technical Information	6.92
Thicknet	6.83 18.13
Transmission Cable	6.59–6.71
Triax Cable	6.51–6.54, 6.90 19.59–19.62
Twinax Cable	6.81, 6.87–6.88 19.58
Industrial	18.14–18.18
Video Triax Cable	6.51–6.54
Wireless RF Transmission Cable	6.59–6.66
Color Code Charts	22.17–22.19
Commercial Networking – Copper	
Connectivity	15.6–15.45
Introduction	15.2–15.5

Products (continued)	
Commercial Networking – Copper (continued)	
110 Cross-Connect System	15.18–15.20
Belden IBDN® System 10GX®	15.6–15.8
BIX Cross-Connect System	15.13–15.17
GigaBIX® Multi System	15.9–15.12
Labels	15.21
Line Protection and Bonding & Grounding	15.45
Modular Cords	15.41–15.43
Network Connectivity Products	15.44
Patch Panels	15.22–15.24
Shipboard Cable	15.67
Workstation Outlets	15.25–15.40
Cables	15.46–15.82
Certified System Cables	15.46–15.51
D-Series Cable	15.64–15.65
DataBrite® Cable	15.56–15.57
DataTwist® Cable	15.46 15.50, 15.52–15.57 15.61, 15.63 15.67–15.69 15.71, 15.73
GigaFlex® Cable	15.47, 15.49 15.51
IBDN Plus Cable	15.58–15.59 15.62
MediaTwist® Cable	15.48, 15.72
Shielded Twisted Pair (ScTP) Cables	15.66–15.68
Special Application Cables	15.69–15.81
Unshielded Twisted Pair (UTP) Cables	15.52–15.65
VideoTwist® Cable	15.70
Commercial Networking – Optical Fiber	
Connectivity	16.4–16.17
Introduction	16.2–16.3
FiberExpress™ Connectors	16.4–16.5
FiberExpress Manager	16.11
FiberExpress Outlets	16.15–16.16
FiberExpress Patch Panel Accessories	16.14
FiberExpress Patch Panels	16.12–16.13
FiberExpress Secure/Keyed LC System	16.9–16.10
Network Connectivity Products	16.17
Pre-connectorized Assemblies	16.6–16.8
Cables	16.18–16.34
Cable Selection Guide	16.18
Breakout Style Cable	16.22–16.23 16.32–16.33
Central Tube Cable	16.31
Distribution Cable	16.20–16.21
Double Jacket, Armored	16.29
Double Jacket, Heavy-Duty	16.30
Industrial Armored	16.24
Interconnect – Simplex & Duplex	16.19
Low Smoke Zero Halogen	16.20–16.23
Micro Loose Tube Breakout Style	16.32–16.33
Plenum Cable	16.19–16.24 16.26, 16.28
Ribbon Cable	16.26
Riser Cable	16.19–16.24 16.26–16.27 16.29 16.32–16.34
Single Jacket, All Dielectric	10.11–10.12
Tactical Cable	10.9
TrayOptic® Heavy-Duty, All Dielectric	10.18

Products (continued)	
Commercial Networking – Training	
Overview	17.1–17.6
Copper Products	17.2
Design and Concept	17.5
End-to-End Installation/Testing – Copper	17.4
End-to-End Installation/Testing – Optical Fiber	17.6
Intro to Belden	17.3
Installation	17.4
Optical Fiber Products	17.5
Project Management	17.3
Commercial Alarm, Security & Sound Cables (See New Generation®)	
Communication Cable	
	4.15
	5.46
	6.82
	19.38–19.40
	20.28–20.32
MIL-Spec Communication & Instrumentation Cable	4.15
Multi-Conductor	4.15
Residential	21.9–21.11
Composite Cable	
	6.39
	19.69–19.73
	20.35–20.36
	20.42–20.47
	21.3–21.8
	21.17–21.18
	21.25
Computer Cable	
Coaxial	6.67–6.71 6.83–6.90
Datalene® Insulated	4.2 4.10, 4.16, 4.18 5.3
	5.14–5.15
	5.17, 5.27
	5.31, 5.35
	5.44–5.45
	15.75–15.76
	15.80
	18.17
	18.28–18.29
DataTwist® Cable	15.46, 15.50 15.52–15.57 15.61, 15.63 15.67–15.69 15.71, 15.73
EIA Interface Cable	4.10
EIA RS-232	4.2, 4.11 4.16–4.19 5.3
	5.11–5.15
	5.26–5.27
	5.29–5.32, 5.36
	5.44–5.45
	5.49–5.50, 5.53
EIA RS-422	5.15, 5.26 5.30–5.31 5.35–5.36 5.44–5.45 5.50, 5.53
EIA RS-423	4.16, 4.18
EIA RS-485	5.14, 5.27–5.28 18.28
Ethernet/IP™ Compliant	18.8–18.9
Flat Cable	7.3–7.12
IBM RISC System/6000 Cable	15.81
IBM Cabling System	15.79–15.80



Table of Contents

Alphabetical Index

Products (continued)	
Computer Cable (continued)	
IEEE 488/Interface	4.16
IEEE 802.3 Trunk and Transceiver Cables	15.74–15.76
IEEE 802.4 (MAP)	15.77–15.78
IEEE 802.5	15.79–15.80
Industrial Data	18.7–18.29
Industrial Ethernet	18.7–18.13
Local Area Network (LAN)	15.46–15.68
Low-Capacitance	4.16, 4.18 5.14–5.15 5.26–5.32 5.35–5.36 5.44–5.45 5.50, 5.52–5.53 19.9, 19.11 19.14–19.15 19.22 19.36, 19.38
Multi-Conductor	4.2 4.10, 4.11 4.16–4.19
Optical Fiber	10.3–10.18 18.12
Paired	5.3 5.11–5.15 5.26–5.36 5.44–5.45 5.49–5.50 5.52–5.53
Plenum-Rated	4.23–4.27 5.48–5.54 15.57–15.59 15.61–15.65 15.67–15.68 15.70–15.71 15.74–15.80 18.8, 18.11 18.13, 18.15 18.17 18.19–18.20 18.29
P.O.S.	5.33, 5.52
Residential	21.9–21.11
RISC System/6000 Cable	15.81
SCSI Assemblies	8.6
Thicknet	6.83 15.74 18.13
Thinnet	6.83 15.74 18.13
Transceiver	15.75–15.76
Triaxial	6.90
Trunk	6.83 15.74 18.3–18.6 18.25
Twinaxial	6.81 6.87–6.88 18.14–18.18
Conductors	22.2–22.5
Conformable® Coaxial Cable	6.62–6.75 19.42
Connectivity – Copper	15.1–15.82
Connectivity – Optical Fiber	16.1–16.34

Products (continued)	
Connectors	
Copper	15.25–15.39
Optical Fiber	16.4–16.5
Control Cable	
High-Temperature	4.28–4.31
Industrial – Belden Infinity®	18.32–18.38
Industrial – CSA Control	18.84–18.95
Industrial – UL Control	18.63–18.76
Multi-Conductor	4.3–4.9 4.12–4.14, 4.20 4.28–4.31 20.28–20.30 20.35–20.36 (also see Industrial section)
Paired	5.4–5.11 5.16–5.24 5.37–5.42, 5.48 5.51, 5.54 20.28–20.29 20.31–20.34 (also see Industrial section)
Plenum-Rated	4.3, 4.5, 4.13 5.48, 5.51, 5.54 20.29–20.32 20.34–20.35
Residential	21.3–21.8
ControlBus™ Cable	18.20
ControlNet™ Cable	18.19
Cross-Connect Systems	15.2–15.20
CSA Cable	18.77–18.95
Instrumentation	18.77–18.83
Control	18.84–18.95
Teck90	18.87–18.94
VFD	18.95
CSA Flame Ratings: FT1, FT4, FT6	22.20
D-Series Cable	15.64–15.65
D-Subminiature Assemblies	8.3–8.5
Data Cable	
Commercial Networking – Copper	15.46–15.82
Commercial Networking – Optical Fiber	16.18–16.34
Industrial	18.7–18.29
Residential	21.9–21.11
DataBrite® Cable	15.56–15.57
DataBus® Cable	18.21
Datalene® Cable	4.2, 4.10 4.16, 4.18 5.3, 5.14–5.15 5.17, 5.27 5.31, 5.35 5.44–5.45 15.75–15.76, 15.80 18.17, 18.28–18.29 19.5, 19.22 19.27–19.29 19.57–19.58 20.33 21.24 22.6
DataTray® Cable	18.18
DataTuff® Cable	18.8–18.11
DataTwist® Cable	15.46, 15.50 15.52–15.57 15.61, 15.63 15.67–15.69 15.71, 15.73
DBS (Direct Broadcast Satellite) Cable	6.31–6.33 21.12

Products (continued)	
DIN Cable Assemblies	8.8–8.9
DeviceBus® Cable	18.22–18.27
DeviceNet™ Cable	18.22–18.24
Digital Audio Cable	5.35–5.36 5.44–5.45 5.53 19.26–19.30 21.3–21.8 21.24
Digital Video Cable	19.49–19.58 21.12–21.16
Digital Video Time Code	19.58
DigiTruck® Mini Coax	19.50
Direct Broadcast Satellite Cable	6.31–6.33 21.12
Direct Burial Cable	3.26 4.13 4.22–4.25 5.41 6.19–6.23 6.25–6.28 6.31, 6.33 6.85, 6.87 10.13–10.15, 10.18 15.74–15.75 15.77–15.78 18.8 18.12–18.13, 18.15 18.19–18.20 18.30 18.41–18.52 18.56–18.95 19.43, 19.45, 19.47 19.53–19.54 19.59–19.62
Distribution Optical Cable	10.4–10.5
DMX512	5.28 18.28 19.27
DS3 & DS4 Telecommunications Cable	6.55–6.58
DT-12 Audio Snake Cable	19.19–19.20
Dual Channel Audio Cable	19.38
Duplex Optical Cable	10.3
Duplex Primary Wire	4.8
EIA RS-232	4.2, 4.11 4.16–4.19 5.3, 5.11–5.15 5.26–5.27 5.29–5.32, 5.36 5.44–5.45 5.49–5.50, 5.53
EIA RS-422	5.15 5.26 5.30–5.31 5.35–5.36 5.44–5.45 5.50, 5.53
EIA RS-423	4.16, 4.18
EIA RS-485	5.14 5.27–5.28 18.28
Enclosures & Accessories	
Introduction	11.1–11.29 11.2
Cable Management Accessories	11.24
Climate Monitor	11.27
Cooling Devices & Fans	11.5, 11.8 11.11, 11.14 11.17, 11.27
Fan Controllers	11.27

ControlNet is a ControlNet International trademark.
DeviceNet is an Open DeviceNet Vendor Association, Inc. trademark.



Table of Contents

Alphabetical Index

Products (continued)	
Enclosures & Accessories (continued)	
Modular Enclosures	11.3–11.19
Modular Enclosure	
Options & Accessories	11.20–11.27
Power Strips & Power Accessories	11.25–11.26
Swing Racks	11.29
Wall Mount Enclosures & Accessories	11.28–11.29
Environmental Regulations and Compliance	22.23
Ethernet Hubs	15.44
European Union Restrictions	22.23
EVAC Systems Cable	20.61–20.64
Faceplates	
Copper System	15.31–15.38
Optical Fiber System	16.15
FEP Cable	
Broadcast	19.9–19.14
	19.24–19.25, 19.27
	19.30, 19.39
	19.43, 19.45
	19.47–19.48
	19.52–19.54
	19.56, 19.59, 19.61
	19.73–19.75, 19.77
Coaxial	6.17–6.20
	6.24–6.26
	6.28, 6.31
	6.35–6.36
	6.38–6.39
	6.42–6.44
	6.46
	6.50–6.51
	6.52, 6.53
	6.55–6.57
	6.68, 6.70
	6.83–6.88
Flat Cable	7.8, 7.10
Industrial	18.8
	18.11, 18.13
	18.15, 18.17
	18.19–18.20
	18.22, 18.29
	18.55
Multi-conductor	4.4, 4.6, 4.13
	4.23–4.27
	4.29, 4.34
Networking	15.46–15.47
	15.49–15.53, 15.55
	15.57–15.59
	15.61–15.62
	15.67–15.68
	15.70–15.71
	15.74–15.80
New Generation®	20.29–20.32, 20.34
	20.38–20.39
	20.41, 20.43
	20.45, 20.47
	20.49–20.50
	20.52, 20.54
	20.60
	20.70, 20.72
Paired	5.6, 5.9
	5.13, 5.16
	5.19–5.21, 5.28
	5.33, 5.36
	5.38, 5.41
	5.48–5.54
Residential	21.9–21.14
	21.18–21.19

Products (continued)	
Fiber Optic Cable	
	10.1–10.18
Cable Selection Guide	10.2
Breakout Style Cable	10.6–10.7
	10.16–10.17
Central Tube Cable	10.15
Distribution Cable	10.4–10.5
Double Jacket, Armored	10.13
Double Jacket, Heavy-Duty	10.14
Industrial Armored	10.8
Interconnect – Simplex & Duplex	10.3
Low Smoke Zero Halogen	10.4–10.7
Micro Loose Tube Breakout Style	10.16–10.17
Plenum Cable	10.3–10.8
	10.10, 10.12
Ribbon Cable	10.10
Riser Cable	10.3–10.8
	10.10–10.11
	10.13
	10.16–10.18
Single Jacket, All Dielectric	10.11–10.12
Tactical Cable	10.9
TrayOptic® Heavy-Duty, All Dielectric	10.18
	18.12
FiberExpress™ Connectivity & Systems	16.2–16.17
Field Installable Fiber Connectors	16.4
Fire Alarm Cable	20.55–20.64
Flamarrest® Cable	19.9–19.14
	19.24, 19.27
	19.30, 19.33–19.34
	19.37, 19.39
	19.41, 19.43
	19.45, 19.47
	19.52, 19.54
	19.71–19.72
	19.74–19.75, 19.77
	20.20–20.27
	20.29–20.32
	20.34–20.35
	20.38–20.39
	20.41, 20.43, 20.45
	20.47, 20.49
	20.52, 20.54
	20.59–20.60
	20.68–20.70, 20.72
	21.9–21.14
	21.16–21.17
	21.19, 21.21
Coaxial	6.17–6.20
	6.24–6.25
	6.31, 6.34–6.36, 6.38
	6.42, 6.49–6.50
	6.56–6.58
	6.68, 6.83, 6.86
Multi-conductor	4.4, 4.6
	4.13
	4.23–4.24
Networking	15.48
	15.52, 15.54–15.55, 15.57
	15.67–15.68
	15.70–15.71, 15.74
	15.79–15.80
Paired	5.6, 5.9
	5.13, 5.16
	5.19–5.21
	5.28, 5.36
	5.38, 5.41
	5.48–5.49
	5.51–5.54

Products (continued)	
Flat Cable	
	7.1–7.14
Gray Ribbon	7.3–7.6
Rainbow	7.7–7.8
Shielded Jacketed	7.11
Shielded Jacketed Vari-Twist®	7.12
Vari-Twist®	7.9–7.10
Technical Information	7.13–7.14
Flexible Automation Cable	18.31–18.40
FlexSnake® Snake Cable	19.20
Flooded Burial Cable	6.25, 6.27–6.28
	6.31, 6.33
Gas Tube Sign & Ignition Cable	3.24
General Purpose Interface Bus (GPIB)	8.7
GigaBIX® Multi System	15.9–15.12
GigaFlex® Cable	15.47, 15.49, 15.51
Glossary of Terms	22.25
Grounding Wire	3.27
Hart Cable	18.28
Hazardous Location Cable Reference	18.97
Heater Cord	9.3
Heavy Metal Free Compliance	22.23
High-Temperature Cable	3.9–3.13, 3.15
	3.19–3.21, 3.25
	4.28–4.31
	5.11
	18.55
Control	4.28–4.31
Instrumentation	4.28–4.31
	18.55
Multi-Conductor	4.28–4.31
Teflon® Wire	3.9–3.11
Thermocouple Extension Cable & Wire	18.55
High Voltage Leads	3.22
Home Automation	(See Residential Cable)
Hook-Up Wire	3.1–3.32
Bus Bar, Antenna & Aluminum Ground Wire	3.27
Direct Burial Cable	3.26
EPDM	3.12–3.13
Gas Tube Sign & Ignition Cable	3.24
High Voltage Leads	3.22
Hypalon®	3.16–3.17
Magnet Wire	3.25
Neoprene	3.18
PVC	3.3–3.8
Shielding & Bonding Cable	3.26
Silicone Rubber	3.19–3.21
SIS	3.15
Technical Information	3.28–3.32
Teflon® Wire	3.9–3.11
Test Prod Wire	3.23–3.24
XL-Dur®	3.14–3.15
Horizontal Cable – Copper	15.46–15.59
	15.61–15.65
	15.67–15.71
	15.74–15.82
Hubs, Ethernet	15.44
	16.17
Hubs, Midspan – Power over Ethernet	14.1–14.5
IBDN® Plus Cable	15.58–15.59
	15.62
IBM Cable	15.79–15.81

Teflon and Hypalon are DuPont trademarks.



Table of Contents

Alphabetical Index

Products <i>(continued)</i>	
IDC Systems	15.9–15.20
IEEE 488 Interface Cable	4.16
Industrial Armored Optical Cable	10.8
Industrial Automation & Control Cables	18.1–18.98
ACIC (CSA) Cable – 300V	18.80–18.81
ACIC (CSA) Cable – 60V	18.83, 18.88
Armored Cable	18.10–18.11
	18.16, 18.19
	18.28
	18.41
	18.71–18.76
	18.80–18.81
	18.83
	18.88–18.94
Belden Infinity®	
Flexible Automation Cable	18.31–18.40
Blue Hose® Cable	18.14–18.16
Blue Hose Selection Guide	18.14
Burial Cable	18.8
	18.12, 18.15
	18.41–18.52
	18.56–18.95
CANopen Cable	18.28
CIC (CSA) Cable – 300V	18.77–18.79
CIC (CSA) Cable – 600V	18.82
	18.84–18.86
Coaxial	18.13
	18.19–18.20
ControlBus™ Coax	18.20
ControlNet™ Coax	18.19
Control Cable	18.63–18.76
	18.84–18.95
CSA Control Cable	18.84–18.95
CSA Instrumentation Cable	18.77–18.83
Data Cables	18.7–18.29
DataBus® FieldBus or Profibus	18.21
Datalene®	18.17
	18.28–18.29
DataTuff® Cable	18.8–18.11
DataTray® 600V Twinaxial Cable	18.18
DeviceBus®	18.22–18.27
DeviceNet™, ODVA	18.22–18.24
EIA Industrial RS-485	18.28
FEP	18.8
	18.11, 18.13
	18.15, 18.17
	18.19–18.20
	18.29
	18.55
Ethernet/IP™ Compliant	18.8–18.9
Fiber Optic Cable	18.12
Flat Cable	18.24
Foundation FieldBus	18.21
Gland Information for Armored Cables	18.96
Hart Cable	18.28
Hazardous Locations Cable Reference	18.97
High Flex Cable	18.15
	18.19–18.20
	18.23
	18.31–18.40
Hi-Temp Extension Cable	18.55
Honeywell Smart Distributed System Cables	18.25

Products <i>(continued)</i>	
Industrial Automation & Control Cables <i>(continued)</i>	
IEEE 802.4 (MAP) & 802.7 (Mini-MAP)	18.17–18.18
Industrial Coax	18.19–18.20
Industrial Communications Protocol	
Cross Reference Guide	18.6
Industrial Data Solutions®	18.7–18.29
Industrial Ethernet	18.7–18.13
Industrial Twinax	18.14–18.18
Infinity, Belden – Control Cable	18.32–18.38
Infinity, Belden – Flex Data Cable	18.39
Infinity, Belden – Flex Vision Cable	18.40
Infinity, Belden – Flexible Automation Cable	18.31–18.40
Instrumentation Cable – CSA	18.84–18.95
Instrumentation Cable – UL	18.77–18.83
Instrumentation 300V, PLTC	18.41–18.42
Instrumentation 600V, TC	18.63–18.64
ITC Cable	18.41–18.55
Interconnect Cable	18.29
Low Smoke Zero Halogen (LSZH) Cable	18.97
MAP and Mini-MAP Cable	18.17–18.18
Metal Clad (Type MC) Cable	18.70–18.76
Motor Supply Cable	18.30
ODVA DeviceNet™ Cables	18.22–18.24
Optical Fiber Cable	18.12
Phoenix Contact Interbus®-S Cables	18.27
PLC/DCS Cables	18.2–18.29
PLC/DCS Cable Cross Reference Guide	18.2–18.5
Plenum	18.8
	18.11, 18.13
	18.15, 18.17
	18.19–18.20
	18.29
	18.55
PLTC Cables	18.9
	18.28
	18.41–18.55
Profibus Cables	18.21
Riser	18.12
Square D/Seriplex® Cables	18.26
TC Cable	(see Tray Cable)
TC-ER Cable	18.56–18.69
Technical Information	18.96–18.98
Teck90 Cable – 600V	18.74–18.76
	18.89–18.91
Teck90 Cable – 1000V	18.92–18.94
Teck-Style® Cable	18.70
	18.74–18.76
Teflon®	18.17
Thermocouple Extension Cable & Wire	18.53–18.55
Thermocouple Tray (CSA) Cable	18.77
Tray (TC) Cable	18.18
	18.56–18.69
	18.77
	18.84–18.86
	18.95
TrayOptic® Cable	18.12
Triads	18.45, 18.48
	18.50–18.52
	18.58
	18.60–18.62
	18.77–18.83
Twinaxial	18.14–18.18
UL Control Cable	18.63–18.76

Products <i>(continued)</i>	
Industrial Automation & Control Cables <i>(continued)</i>	
UL Instrumentation Cable	18.41–18.62
Variable Frequency Drive (VFD) Cable	18.30
Infinity®, Belden —	
Flexible Automation Cable	18.31–18.40
Instrumentation Cable	
Coaxial	6.83–6.90
Flat Cable	7.2–7.12
High-Temperature	4.28–4.31
	18.55
Industrial – CSA Instrumentation	18.77–18.83
Industrial – UL Instrumentation	18.41–18.62
Multi-Conductor	4.3–4.7
	4.12–4.15
	4.20
	4.28–4.31
Paired	5.4–5.11
	5.16–5.24
	5.37–5.42
	5.46–5.48
	5.51, 5.54
Paired – CSA Control	18.77–18.83
Paired – UL Control	18.42–18.44
	18.46–18.47
	18.49
	18.51–18.52
	18.54–18.55
	18.57–18.62
Plenum-Rated	4.3, 4.5
	4.13
	5.48–5.54
Plenum-Rated, UL Instrumentation	18.55
Insulations	18.98
	22.6–22.12
Intercom System Cable	20.28–20.32
ITC Cable	18.41–18.55
Jackets	18.97–18.98
	22.6–22.12
Jacks	15.25–15.39
Keyboard Assemblies	8.10
Keypad Cable (Residential)	21.8
KU Band Cable	6.31–6.33
	21.12
Lamp Cordage	9.3
Land Mobile Radio Coax	6.59–6.66
Lead Wire	(see Hook-Up Wire)
Line-Level Audio Cable	19.9–19.15
Low-Capacitance Cable	(See Computer, Low-Capacitance Cable)
Low Noise Audio Coaxial Cable	6.82
Low Smoke, Zero-Halogen Cables	5.19
	5.38, 5.40
	6.19, 6.44
	10.4–10.7
	15.47, 15.49
	15.62, 15.67
	18.97
	19.12
	19.54, 19.76
Magnet Wire	3.25
MAP & Mini-MAP Cables (IEEE 802.4 & 802.7)	15.77–15.78
MATV Cable	6.16, 6.38
Media Converters	15.44
MediaTwist® Cable	15.48
	15.72

ControlNet is a ControlNet International trademark.
 DeviceNet is an Open DeviceNet Vendor Association, Inc. trademark.
 Teflon is a DuPont trademark.



Table of Contents

Alphabetical Index

Products (continued)	
Metal Clad (MC) Cable	18.70–18.76
Metric Conversions	22.15–22.16
Microphone & Musical Instrument Cable	19.3–19.8
Microwave Cable	6.72–6.73
Midspan Hubs for Power over Ethernet	14.1–14.5
Military Specifications	
JAN-C-17A	6.69
MIL-C-17D	6.67, 6.69 6.84–6.85
MIL-C-17G	6.76–6.81
MIL-W-76C	3.7
MIL-W-16878/1 (Type B)	3.7
MIL-W-16878/4 (Type E)	3.10–3.11 4.30–4.31
MIL-W-16878/5 (Type EE)	3.9
MIL-W-16878/6 (Type ET)	3.11
Mini-MAP Cables	15.77–15.78
Modular Cords	15.41–15.43
Modular Enclosures & Accessories	11.1–11.29
Modular Keyboard Assemblies	8.10
Modules	15.25–15.39
Molded Cable Assemblies	
D-Subminiature Assembly	8.1–8.12
DIN Cable Assembly	8.3–8.5
GPIO Cable Assembly	8.8–8.9
Modular Keyboard Assembly	8.7
Parallel Interface Assembly	8.10
SCSI Cable Assembly	8.11
Technical Information	8.6
Motor Supply Cable	8.12
	18.30
	18.95
Multi-Conductor Cable	
Fire Alarm Cable	4.1–4.34
High-Temperature Control & Instrumentation Cable	4.32–4.34
Overall Beldfoil® Shield	4.28–4.31
Overall Braid Shield	4.10–4.13
Overall Braid & Special Shielding	4.15
Overall Foil/Braid Shield	4.14
Overall Shield	4.16–4.19
Plenum-Rated	4.20–4.22
RS-232 Shielded Cable Selection Guide	4.23–4.27
Unshielded	4.2
	4.3–4.9
Musical Instrument Cable	19.3–19.8
NanoSkew® UTP Cables	19.74–19.75
National Electrical Code (NEC) Reference Information	
	22.20–22.21
New Generation® Cable	
Cable Finder Guide	20.1–20.72
Access Control Banana Peel® Cable	20.3–20.7
Audio Cable	20.35–20.36
Audio Cable for Nurse Call Stations	20.67–20.70
CATV Cable	20.71–20.72
CCTV Surveillance Cable	20.48–20.49
	20.37–20.47
	20.50–20.54
Circuit Integrity (CI)	
Safe-T-Line® Cable	20.63–20.64
Circuit Integrity in Conduit (CIC)	
Safe-T-Line Cable	20.61–20.62
Communication and Control Cable	20.28–20.32

Products (continued)	
New Generation® Cable (continued)	
Fire Alarm Cable	20.55–20.64
MATV Cable	20.48–20.49
Pan/Tilt/Zoom Banana Peel®	
Composite Cable	20.42–20.47
Pan/Tilt/Zoom (PTZ) Camera Cable	20.38
	20.40–20.47
	20.51–20.54
Pro-Audio and Intercom System Cable	20.28–20.32
	20.70
Security and Alarm Cable	20.8–20.27
Security and Surveillance CCTV Cable	20.37–20.41
Security Coaxial Cable	20.48–20.50
Speaker Cable	20.65–20.66
Thermostat and Control Cable	20.33–20.34
UTP CCTV Surveillance Cable	20.51–20.54
Water-blocked Cable	20.19
	20.37
Networking Cable	
(See Commercial Networking: Copper and Commercial Networking: Optical Fiber)	
Network Connectivity Products	15.44
Network Tester	15.44
Nurse Call System Audio Cable	20.71–20.72
ODVA DeviceNet™ Cable	18.22–18.24
Open Frame Racks & Accessories	12.1–12.10
Introduction	12.2
Cable Ties	12.8–12.10
Open Frame Racks & Accessories	12.3–12.7
Optical Fiber Cable	10.1–10.18
Cable Selection Guide	10.2
Breakout Style Cable	10.6–10.7
	10.16–10.17
Central Tube Cable	10.15
Distribution Cable	10.4–10.5
Double Jacket, Armored	10.13
Double Jacket, Heavy-Duty	10.14
Industrial Armored	10.8
Interconnect – Simplex & Duplex	10.3
Low Smoke Zero Halogen	10.4–10.7
Micro Loose Tube Breakout Style	10.16–10.17
Plenum Cable	10.3–10.8
	10.10, 10.12
Ribbon Cable	10.10
Riser Cable	10.3–10.8
	10.10–10.11
	10.13
	10.18
Single Jacket, All Dielectric	10.16–10.18
	10.11–10.12
Tactical Cable	10.9
TrayOptic® Heavy-Duty, All Dielectric	10.18
	18.12
Optimax® Connectors	16.4
Outlets, Optical Fiber	16.15–16.16
Packaging, Cable	22.24
Parallel Interface Assemblies	8.11
Parallel Lamp Cordage	9.3
Paired Cables	5.1–5.54
Selection Guide	5.3
Combination Unshielded & Braid Shield	5.23
Individually Shielded	5.34–5.42
Individually Shielded Pairs	
with Overall Foil/Braid Shield	5.43–5.47

Products (continued)	
Paired Cables (continued)	
Overall Beldfoil® Shield	5.10–5.22
Overall Braid Shield	5.23
Overall Foil/Braid Shield	5.25–5.33
Overall Spiral Shield	5.24
Plenum-Rated	5.48–5.54
Shielded Multi-Pair Cable Selection Guide	5.3
Shipboard Audio/Video Cables	5.19
	5.38
	5.40
Unshielded	5.4–5.9
Patch Cords	
Copper	15.41–15.43
Optical Fiber	16.6–16.8
Patch Panels	
Copper	15.6, 15.22–15.24
Optical Fiber	16.12–16.14
PLC/DCS Cable	18.2–18.29
PLC/DCS Cross Reference Guide	18.3–18.5
Plenum Cable	
Broadcast	19.9–19.14
	19.24–19.25
	19.27, 19.30
	19.33–19.34
	19.37, 19.39
	19.41
	19.43, 19.45
	19.47–19.48
	19.52–19.54
	19.56, 19.59
	19.61
	19.71–19.75
	19.77
CATV Coax	6.17–6.20
	6.24–6.26
	6.28
Coaxial	6.17–6.20
	6.24–6.26
	6.28, 6.31
	6.34–6.36
	6.38–6.39
	6.42–6.44
	6.46, 6.48–6.51
	6.53, 6.55–6.57
	6.68
	6.70, 6.77
	6.83–6.88
Industrial	18.8
	18.11, 18.13
	18.15, 18.17
	18.19–18.20
	18.29
	18.55
Local Area Network (LAN)	15.57–15.59
	15.61–15.65
	15.67–15.68
	15.70–15.71
	15.74–15.80
Low-Capacitance	5.50, 5.52–5.53
Multi-Conductor	4.3, 4.5
	4.13
	4.23–4.27
	4.34
New Generation® Cable	20.20–20.27
	20.29–20.32
	20.34–20.35
	20.38–20.39
	20.41, 20.43
	20.45, 20.47

DeviceNet is an Open DeviceNet Vendor Association, Inc. trademark.



Table of Contents

Alphabetical Index

Products (continued)	
Plenum Cable (continued)	
New Generation® Cable (continued)	20.49
	20.52, 20.54
	20.59–20.60
	20.68–20.70
	20.72
Optical Fiber	10.3–10.8
	10.10, 10.12
Paired	5.6, 5.9
	5.13, 5.16
	5.19–5.21
	5.28
	5.33, 5.36
	5.38, 5.41
	5.48–5.54
Residential	21.9–21.14
	21.16–21.19
	21.21
PoE Products	14.1–14.5
Portable Cordage	9.2–9.12
2-Conductor	9.3–9.5
3-Conductor	9.6–9.9
4-Conductor	9.9
5-Conductor	9.9
Multi-Conductor	9.10
UL Cordage Types	9.11–9.12
P.O.S. Computer Cable	5.33
Power-Limited Tray Cable, PLTC	18.9
	18.28
	18.41–18.55
Power over Ethernet (PoE) Products	14.1–14.5
PowerSense® PoE Products	14.1–14.5
Introduction	14.2
Midspan Hubs	14.3–14.4
Accessories	14.5
Power Strips & Power Accessories	11.25–11.26
Preterminated Fiber Assemblies	16.6–16.8
Process Control Cable	18.1–18.98
Professional Music Cable	19.3–19.8
	19.38–19.40
Profibus Cable	18.21
PTZ (Pan/Tilt/Zoom) Camera Cable	20.42–20.47
Quad, Mini-Star	19.8
Raceways	13.1–13.3
Racks	12.1–12.7
Rainbow Flat Cable	7.7–7.8
Residential Cable	21.1–21.26
Alarm, Security and Speaker Cable	21.24
Audio Cable	21.24
Banana Peel® Cable	21.3–21.4
	21.17–21.18
Broadband Cable	21.12–21.13
CATV Cable	21.12–21.13
Coaxial Cable	21.12–21.19
Composite Cable	21.3–21.8
Data & Voice Cable	21.9–21.11
DBS Cable	21.12
Digital Audio Cable	21.24
Fiber Optic Cable	21.3–21.4, 21.6
Keypad Cable	21.8
Security & Alarm Cable	21.24
Speaker Cable	21.20–21.24

Products (continued)	
Residential Cable (continued)	
Surveillance Coax	21.25
UTP Cable	21.3–21.11
Video Cable	21.12–21.16
Restriction on Hazardous Substances (RoHS) Regulations	22.23
Retractable Assemblies	8.10
RF Coaxial	6.59–6.66
RGB Coaxial	6.47–6.49
	19.69–19.73
	21.16
Ribbon Flat Cable	7.3–7.5
Ribbon Optical Cable	10.10
Rip Cordage	9.3
	19.32
	21.23
Riser Cable	
Industrial	18.12
New Generation® Cable	20.36
	20.40, 20.42
	20.44, 20.46
	20.51
	20.61–20.65
	20.67
Optical Cable	10.3–10.8
	10.10–10.11
	10.13, 10.18
RISC System/6000 Cable	15.81
Roadway Loop Cable	3.26
Robotic Cable	18.31–18.40
RoHS Regulations	22.23
Rotor Cable	4.8
Safe-T-Line® CI/CIC Cable	20.61–20.64
Satellite, Direct Broadcast Cable	6.31–6.33
	21.12
SCSI (Small Computer System Interface) Cable	15.82
Secure Fiber Connectivity	16.9–16.10
Security & Alarm Cable	20.1–20.72
	21.24
Serial Digital (SDI) & High Definition (HD) Coaxes	19.50
	19.52
	19.54–19.56
Shipboard Audio/Video Cables	5.19
	5.38, 5.40
	15.67
	19.10, 19.12
	19.76
Shielding & Bonding Cable	3.26
Shielding, Technical Information	22.12–22.14
Simplex Optical Cable	10.3
SIS Wire	3.15
Small Computer Systems Interface (SCSI)	8.6
	15.82
SMPTE 311 HD Camera Cable	19.64
Snake Cable	6.45–6.46
	19.16–19.25
	19.28
Sound Cables, Commercial	20.65–20.72
Speaker Cable	
Brilliance® Broadcast	19.31–19.36
New Generation®	20.65–20.66
Residential	21.20–21.23

Products (continued)	
Special Application Audio	19.38–19.40
Stereo Connecting Cable	19.38
Structured Cable	21.9–21.11
	(also see Commercial Networking – Copper & Optical Fiber)
Structured Cabling Systems	
Copper	15.1–15.82
Optical Fiber	16.1–16.34
Training	17.1–17.6
Surface Raceway Systems	13.1–13.3
Surveillance Cable	20.37–20.54
	21.25
SVHS (S-Video) Cable	19.77
	21.19
Synchronous EIA Interface Cable	4.10
Teck90 Cable	
600V	18.74–18.76
	18.89–18.91
1000V	18.92–18.94
Teck-Style® Cable	18.74–18.76
Teflon® Cable	3.9–3.11
	4.30–4.31
	6.17–6.18
	6.28
	6.53
	6.67–6.68
	6.72–6.74
	6.76–6.77
	6.79–6.81
	6.84
	6.86–6.88
	15.46, 15.48
	15.50, 15.53
	15.57
	15.61
	15.67–15.68
	15.75
	15.79–15.80
	18.17
	19.27
	19.42
	19.52, 19.54
	19.61
	19.75, 19.77
Tefzel® Cable	4.28–4.29
	5.11
Telephone Cable	5.4
Terms of Use of Master Catalog	22.22
Test Prod Wire	3.23–3.24
Test Unit, Ethernet Network	15.44
Thermocouple Extension Cable & Wire	18.53–18.55
Thermostat and Control Cable	20.33–20.34
Thicknet	6.83
	15.74
	18.13
Thinnet	6.83
	15.74
	18.13
Tools – Cable Prep, Connecting, Terminating	15.17
	15.40
	16.4
Training, Commercial Networking	17.1–17.6
Transceiver Cable	15.75–15.76
Transceivers	15.44

Teflon and Tefzel are DuPont trademarks.



Table of Contents

Alphabetical Index

Products (continued)	
Tray Cable (TC)	
PLTC	18.8 18.28 18.41–18.55
TC – CSA	18.77 18.84–18.86 18.95
TC – UL	18.18 18.56–18.69
TC-ER	18.56–18.62 18.63–18.69
TrayOptic® Cable	10.18 18.12
Triads	4.20 18.45, 18.48 18.50–18.52, 18.58 18.60–18.62 18.77–18.83
Triaxial Cable	6.51–6.54 6.90 19.59–19.62
Trunk Cable	6.83 15.74 18.3–18.6 18.25
TV Antenna Cable	3.27 4.8
TV Camera Cable	19.63–19.68
Twinaxial Cable	6.81 6.87–6.88 18.14–18.18
Vari-Twist® Flat Cable	7.9–7.10 7.12
Variable Frequency Drive (VFD) Cable	18.30 18.95
Video Cable	19.41–19.77 21.3–21.8 21.12–21.16 21.25
Video Snake Cable	6.45–6.46
VideoTwist® UTP Cable	15.70 19.74–19.76
Wall Mount Enclosures & Accessories	11.28–11.29
Wi-Fi Tower Cable	19.76
Wireless 50 Ohm Coax	6.59–6.66
Workstation Outlets	15.25–15.39
XL-Dur® Wire	3.14–3.15
Zip Cord	9.3 19.32 21.23

Tech Info, Charts & Graphs	
AES/EBU Digital Audio Cable	
Digital Audio Attenuation	19.26
Max. Recommended Transmission Distances	19.26
Armored Cable – Gland Information	18.96
Armoring	22.14
Attenuation	
Broadband Coax Attenuation vs. Frequency	6.92
Coaxial Computer Cable	6.66 6.71, 6.75 6.89
Flat Cable	7.3–7.12
Paired Cable, Individually Shielded	5.34, 5.39

Tech Info, Charts & Graphs (cont'd)	
Attenuation (continued)	
Paired Cable, Individually Shielded & Overall Foil/Braid Shield	5.43
Paired Cable, Overall Beldfoil® Shield	5.10
Paired Cable, Overall Foil/Braid Shield	5.25
Twinaxial Cable	6.89
Belden IBDN® Networking Products	
Copper Systems Selection Guide	15.4–15.5
System 10GX®	15.2–15.5
Tools	15.40
Belden Infinity® Cable Application Guide	18.31
Bit Rate	
Coaxial Computer Cable	6.89
Paired Cable, Individually Shielded	5.34, 5.39
Paired Cable, Individually Shielded & Overall Foil/Braid Shield	5.43
Paired Cable, Overall Beldfoil® Shield	5.10
Paired Cable, Overall Foil/Braid Shield	5.25
Twinaxial Cable	6.89
Blue Hose® Cable Selection Guide	18.14
Cable Finder Reference Guide	2.1–2.40
Cable Substitution Chart (per NEC)	22.21
Cable Ties Selection Guide	12.2
Canadian Standards Reference	22.20 22.22
Color Code Charts 22.17–22.19 (Also refer to respective cable section)	
Conductors	22.2–22.5
Conformable® Coaxial Cable – Electrical Characteristics	6.75
Connector, Audio/Video – Specifications (Residential)	21.26
Crosstalk (Flat Cable)	7.13–7.14
CSA Control Cable	18.84, 18.87 18.95
CSA Instrumentation Cable	18.77
Current Ratings	22.4
DataTuff® Industrial Ethernet Cable Selection Guide	18.7
DeviceNet™ (ODVA) Communications Rate Table	18.22
DS-3 & DS-4 Cable – Maximum Transmission Distances	6.58
Enclosures (Freestanding) Selection Guide	11.2
Environmental Regulations & Compliance	22.23
Fiber Optics	(see Optical Fiber)
Glossary of Terms	22.25–22.36
Halogen Free Low Smoke (LSZH) Cable Information (Industrial)	18.97
Hazardous Locations Cable Reference	18.97
Index	23.1–23.16
Industrial Ethernet Cable Selection Guide	18.7
Insulations	22.6–22.12
Industrial	18.98
Jackets	22.6–22.12
Industrial	18.98
Lead Wire	
Color Code Chart	3.29
Conductor & Insulation Information	3.28 3.31
Current Carrying Capacity	3.30

Tech Info, Charts & Graphs (cont'd)	
Lead Wire (continued)	
Insulation Characteristics	3.29
Packaging	3.32
Temperature Ranges	3.31
Metric Conversions	22.15–22.16
Molded Cable Assemblies	
How To Measure a Molded Cable Assembly	8.12
Retention Systems, D-Subminiature	8.12
NEC Ratings	22.20–22.21
New Generation® Cable Finder Guide	20.3–20.7
Optical Fiber	
Color Code Charts	10.2 16.18
Fiber Channel Topology	16.3
FiberExpress Systems	16.2
Fiber Selection Guide	10.2 16.18
Optical Specifications	10.2 16.18
Phase Stability (Coax)	
	6.66 6.75
PLC/DCS Cable Cross Reference Guide	18.3–18.6
Power over Ethernet, Information	14.2
Power Rating, Coaxial	6.66 6.71, 6.75
Racks (Open Frame) Selection Guide	12.2
RG Coaxial & Triaxial Reference Guide	6.3–6.15
Rise Time	
Coaxial Computer Cable	6.89
Paired Cable, Individually Shielded	5.34, 5.39
Paired Cable, Individually Shielded & Overall Foil/Braid Shield	5.43
Paired Cable, Overall Beldfoil® Shield	5.10
Paired Cable, Overall Foil/Braid Shield	5.25
Twinaxial Cable	6.89
Serial Digital Data Rates – Maximum Transmission Distances	
	19.58 19.78
Serial Digital Video (SDI) Specifications	
Shielded Multi-Conductor Computer Cable for RS-232 Applications	4.2
Shielded Multi-Pair Computer Cable for RS-232, RS-422, & RS-485 Applications	5.3
Shielding & Armoring	22.12–22.14
Snake Cable (Audio) Selection Guide	19.16
Speaker Cable Selection Guide	19.31
Thermocouple Wire Identification & Limits of Error	18.53
Transfer Impedance	
Coaxial Computer Cable	6.89
Twinaxial Cable	6.89
UL Control Cable	18.63 18.70, 18.77
UL Cordage Types	9.11–9.12
UL Instrumentation Cable	18.41 18.53, 18.56
Unbalanced Crosstalk (Flat Cable)	7.3–7.13
Vertical Tray Flame Test Comparison	18.98
VSWR Limits	6.66 6.75
Wireless 50 Ohm Coax – Electrical Characteristics	6.66 6.71

DeviceNet is an Open DeviceNet Vendor Association, Inc. trademark.



Table of Contents

Alphabetical Index

UL Cable Finder Chart			
Style No.	Volt/Temp	Page No.	
1007	300V 80°C	3.4	
		4.6	
		19.33	
1015	600V 105°C	3.5-3.6	
1028	600V 105°C	3.6	
1061	300V 80°C	3.3	
1180	300V 200°C	3.9	
1213	105°C	3.10	
1277	600V 90°C	18.30	
1283	600V 105°C	3.6	
1354	30V 60°C	6.34, 6.36	
		6.47-6.48	
		6.67, 6.69	
		6.77-6.78	
		6.80, 6.83, 6.85	
		15.74	
		18.13	
		19.41, 19.44	
		19.69-19.70	
		30V 75°C	6.35, 6.37
			6.41
			6.67
			19.43, 19.46
			19.51
		30V 80°C	6.30
	6.35-6.36		
	6.38		
	6.43		
	6.68-6.70		
	6.76		
	18.40		
	19.43-19.45		
	19.47		
	19.53		
	21.15		
1371	105°C	3.11	
1375	30V 60°C	6.34	
		19.41	
1424	330V 105°C	4.32-4.33	
		4.34	
1478	30V 60°C	6.83, 6.85	
		15.74	
		18.13	
1569	300V 105°C	3.4	
1641	30V 75°C	6.53	
		19.61	
1770	300V 80°C	19.38	
1855	5000V 80°C	3.23	
2092	300V 60°C	4.3	
		5.16, 5.18	
		5.20-5.21	
		6.87-6.88	
		18.16-18.17	
		18.29	
		19.9, 19.11	
		19.13-19.14	
		4.3	
		4.12-4.13	
2093	300V 60°C	4.3	
		4.3	
		5.23, 5.47	
		19.8	
		19.40	
2094	300V 60°C	4.12	
		4.14	
		5.23-5.24	
2095	300V 80°C	19.11	
		19.13	
		19.13	
		4.13	
2107	600V 60°C	4.13	

UL Cable Finder Chart		
Style No.	Volt/Temp	Page No.
2384	30V 60°C	4.10
2448	30V 60°C	6.88
		18.17
		19.58
2464	300V 60°C	18.15
	300V 80°C	4.5, 4.8
		4.11, 4.13-4.14
		4.16-4.17, 4.19
		4.21
		5.7-5.8
		5.11-5.12
		5.17-5.18
		5.20, 5.29
		5.32, 5.37-5.38
		5.41
		6.87
		8.3-8.5
		8.7-8.9
		8.11, 18.15
		18.25
		19.13
	300V 105°C	4.32
	300V 200°C	4.34
2493	300V 60°C	5.35
		18.29
		19.29
	60°C	5.44-5.45
2497	60°C	19.68
2576	150V 80°C	4.3-4.4
		4.7-4.8
		5.4-5.5
2582	150V 60°C	5.33
2587	600V 90°C	5.9
		19.35
		18.32-18.38
2594	75°C	19.67
2598	300V 60°C	4.5-4.6
		5.9
		19.35
2651	300V 105°C	7.4-7.6
2668	30V 60°C	6.48
		6.88
		18.17
		19.70
		5.17
2678	150V 105°C	7.3
2693	300V 105°C	7.9
2697	300V 80°C	7.9
2717	80°C	5.46
2785	300V 80°C	4.14
2884	300V 105°C	7.7
2919	30V 80°C	4.16, 4.18
		5.14-5.15
		5.27-5.28
		5.30-5.31
		5.33, 5.37
		5.40, 5.42
		8.5-8.6
		15.75-15.76
		18.29
		19.23, 19.57
2960	30V 60°C	5.26
3044	300V 90°C	3.18
3046	600V 90°C	3.18
3048	600V 90°C	3.18
3049	600V 90°C	3.18
3069	600V 150°C	3.21

UL Cable Finder Chart		
Style No.	Volt/Temp	Page No.
3070	600V 150°C	3.21
3071	600V 200°C	3.20
3074	600V 200°C	3.20
3075	600V 200°C	3.20
3101	600V 150°C	3.21
3123	600V 150°C	3.21
3125	600V 200°C	3.20
3126	600V 200°C	3.20
3135	600V 200°C	3.19
3173	600V 125°C	3.14
3190	300V 105°C	3.17
3191	600V 105°C	3.16
3192	600V 105°C	3.16
3193	600V 105°C	3.16
3195	600V 125°C	3.14
3196	600V 125°C	3.14
3199	300V 105°C	3.14
3212	600V 150°C	3.19
3213	600V 150°C	3.19
3214	600V 150°C	3.19
3239	80°C	3.22
3321	600V 150°C	3.15
3340	600V 125°C	3.12
3374	600V 150°C	3.12
3436	600V 150°C	3.15
3484	600V 125°C	3.13
3499	7500V 150°C	3.13
10245	30V 105°C	6.72-6.74
		19.42
20006	30V 60°C	19.65
20063	300V 80°C	6.84
20081	300V 105°C	7.11-7.12
20197	30V 60°C	8.3, 8.10
20201	600V 75°C	18.21
		18.23-18.24, 18.26
20233	300V 80°C	18.27
20253	600V 80°C	5.22
		19.15
20468	150V 150°C	7.8, 7.10
GTO-10	10kV 105°C	3.24
MC	600V 90°C	18.70-18.76
SIS	600V 90°C	3.15
TC	600V 75°C	18.18
		18.63-18.69
Portable Cordage		
HPN	300V 90°C	9.3
S	600V 60°C	9.6
SJ	300V 60°C	9.4, 9.6
SJO	300V 90°C	9.4, 9.7
SJT	300V 60°C	9.7
	300V 75°C	9.7
SJTOW	300V 105°C	9.4, 9.8
SO	300V 60°C	9.9
	600V 60°C	9.10
	600V 90°C	9.4, 9.6, 9.9
SP-1	300V 60°C	9.3
SPT-1	300V 60°C	9.3
SPT-2	300V 60°C	9.3
STOW	600V 105°C	9.5, 9.8
SV	300V 60°C	9.5, 9.8
SVT	300V 60°C	9.5, 9.8-9.9





Cable Finder Guide

2

The Belden® Cable Finder Guide is a tool for the user of the Belden Master Catalog. It is designed to give quick access and page reference to current Belden product offerings by AWG size, shielding type and number of conductors.

Use the Cable Finder to locate where the specific cable you seek is detailed in the body of the catalog.

Table of Contents

Cable Finder Guide	Page No.
Multi-conductor and Paired Cable	2.2–2.29
Less than 25 Conductors	2.2
25 or More Conductors	2.22
Combination Gages	2.28
Partially Shielded Cable	2.29
Paired Cable	2.30–2.40

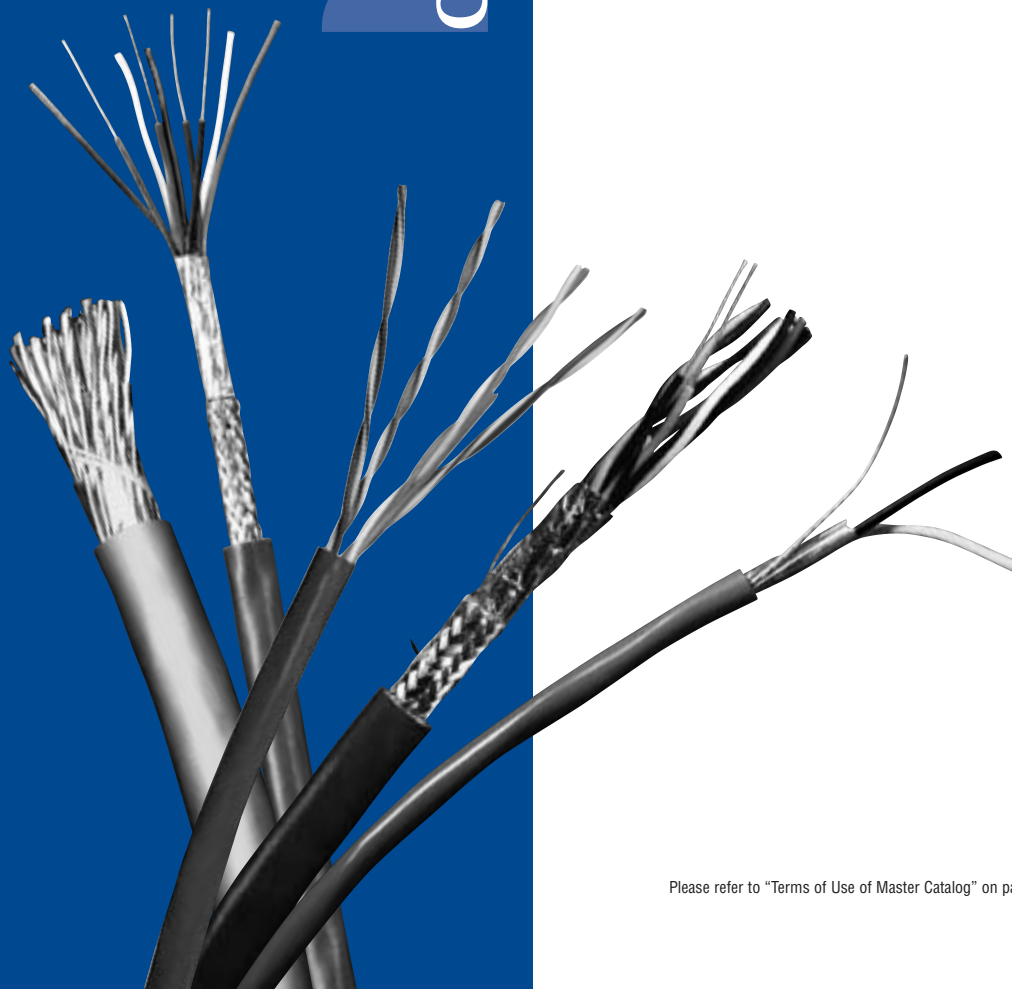

Multi-conductor and Paired Cable

Less than 25 Conductors

No. of Conductors	Unshielded		Spiral Shield		Braid Shield		Overall Beldfoil®		Overall Foil/Braid		Individual Beldfoil		Individual Braid	
	Part No.	Page	Part No.	Page	Part No.	Page	Part No.	Page	Part No.	Page	Part No.	Page	Part No.	Page
25 AWG and smaller														
1	—	—	—	—	83303E	4.30	—	—	—	—	—	—	—	—
2	—	—	9454 8416	19.38 19.38	83317E	4.30	9180 9271	19.27 19.58 6.88	—	—	—	—	—	—
3	—	—	8791	4.14	83332E 8643	4.30 4.14	—	—	—	—	—	—	—	—
4	—	—	—	—	83347E 1804A 1172A	4.30 19.8 19.8	1211A* 8132FO	4.21 5.14	9804 8132	5.26 5.27	1215A■ 7891A■	15.80 19.28	—	—
6	—	—	—	—	—	—	1212A* 8133FO	4.21 5.14	9791 9805 8133 1538A	4.16 5.26 5.27 15.81	—	—	—	—
7	—	—	—	—	—	—	—	—	1540A	15.81	—	—	—	—
8	—	—	—	—	—	—	1213A* 8134FO	4.21 5.14	9806 8134	5.26 5.27	7890A■	19.28	7884A♣	19.17
10	—	—	—	—	—	—	8135FO	5.14	9807 8135	5.26 5.27	—	—	—	—
14	—	—	—	—	—	—	—	—	9808	5.26	9868■	4.10	—	—
16	—	—	—	—	—	—	1214A* 8138FO	4.21 5.14	8138	5.27	7880A■	19.28	7885A♣	19.17
18	—	—	—	—	—	—	—	—	9809	5.26	—	—	—	—
24	—	—	—	—	—	—	—	—	9812	5.26	7892A■	19.28	—	—
24 AWG														
1	—	—	—	—	83304E	4.30	—	—	—	—	—	—	—	—
2	8782	19.32	9397 1812A 1813A	19.5 19.5 19.6	83318E 8413 9399 1800F	4.30 19.5 19.5 19.5 19.27	9452 9501 8641 82641 88641 1508A 1800B 1801B 1883A	19.6 5.11 19.9 5.16 19.9 5.13 19.9 5.16 19.27 21.24 19.27 5.16 19.9	9841 82841 89841 7200A 7205A 7206A	5.28 5.28 5.52 5.28 18.39 18.39 18.39	—	—	—	—
3	—	—	9398	19.7	83333E 8406	4.30 19.7	9533	4.11	9608 9925 83503	4.17 4.18 4.25	—	—	—	—
4	9562▼ 1588A▼ 1588R▼ 1590A▼ 1227A1▼ 1243A2▼ 7932A 24501922	5.4 15.56 15.56 15.57 15.63 15.63 18.6 18.7 18.8 15.64	—	—	83348E 1192A	4.30 19.8	9534 9502 82502 88102 89842 1419A 7933A	4.11 5.11 5.13 5.49 5.50 5.28 5.52 5.15 18.9	9609 9927 83504 9842 82842 8332 9829 8102 7201A	4.17 4.18 4.25 5.28 5.28 5.52 5.29 5.30 5.31 18.39	9729 89729 82729	5.35 19.29 5.36 5.53 19.30 5.36 5.53 19.30 5.44 19.19 19.27	1902A	19.20
5	—	—	—	—	—	—	9535	4.11	9610 9929	4.17 4.18	—	—	—	—

▼ Solid conductors * Armored ■ Individually shielded pairs or triads, plus overall foil, overall braid or overall foil and braid. † Triad
 ◆ Siamese version • Duofoil® shield ♣ Quad



Multi-conductor and Paired Cable

Less than 25 Conductors

No. of Conductors	Unshielded		Spiral Shield		Braid Shield		Overall Beldfoil®		Overall Foil/Braid		Individual Beldfoil		Individual Braid	
	Part No.	Page	Part No.	Page	Part No.	Page	Part No.	Page	Part No.	Page	Part No.	Page	Part No.	Page
24 AWG (continued)														
6	24501934	15.64	—	—	—	—	9536	4.11	9611	4.17	9730	5.35	—	—
	24571097	15.64					9503	5.11	9931	4.18		19.29		
							82503	5.13	83506	4.25	89730	5.36		
								5.49	9843	5.28		5.53		
							89503	5.13	9830	5.30		19.30		
								5.49	8103	5.31	8163 [■]	5.44		
							9680	5.15	3120A	18.27	9990	5.37		
							1420A	5.15	7202A	18.39				
							88103	5.50	8333	5.29				
7	—	—	—	—	—	—	9537	4.11	9612	4.17	—	—	—	—
									9932	4.18				
8	1229A1 [▼]	15.63	—	—	—	—	9538	4.11	9933	4.18	9728	5.35	1904A	19.20
	1245A2 [▼]	15.63					9504	5.11	9844	5.28		19.29		
	1304A	19.76					82504	5.13	9831	5.30	89728	5.36		
	1305A	19.76						5.49	9613	4.17		5.53		
	1500A [▼]	15.54					89504	5.13	8334	5.29		19.30		
	1500R [▼]	15.54						5.49	8104	5.31	8164 [■]	5.44		
		21.10							7921A	18.9	1408R [■]	19.18		
	1501A [▼]	15.54					9681	5.15	7203A	18.39	1510C [■]	19.19		
	1583A [▼]	15.56					88104	5.50						
	1583R [▼]	15.56					1421A	5.15	89842	5.28	1803F [■]	19.28		
		21.11					1533R [▼]	15.67		5.52				
							1533P [▼]	15.67						
	1583B [▼]	15.56					1624R [▼]	15.68						
	1585A [▼]	15.57					1624P [▼]	15.68						
		21.11					1633A [▼]	15.69						
	1585B [▼]	15.57					7919A	18.10						
	1585LC [▼]	15.57					7921A	18.9						
	1592A	15.57					7929A	18.9						
	1594A [▼]	15.56					1300A	19.76						
	1700A [▼]	15.50					1300SB	15.67						
	1700R [▼]	15.50						19.76						
		21.10												
	1701A [▼]	15.50												
		21.10												
	1701LC [▼]	15.50												
	1752A	15.73												
	1875GB	15.72												
	7883A	15.72												
	7918A	18.10												
	7923A	18.8												
	7924A	18.9												
	7928A	18.8												
	7930A	18.10												
	7934A	18.8												
	7987P	19.74												
	7987R	19.74												
	7988P	15.71												
		19.75												
	7988R	15.71												
		19.75												
	7997A	15.56												
	11700A	18.8												
	11700A2	18.8												
121700A*	18.6													
11872A	18.10													
245019XX	15.64													
	15.65													
24566XXX	15.49													
24567XXX	15.49													
24568XXX	15.49													
24570XXX	15.51													
	15.62													
245711XX	15.64													
	15.65													

2 • Cable Finder Guide

[▼] Solid conductors * Armored ■ Individually shielded pairs or triads, plus overall foil, overall braid or overall foil and braid. † Triad
[◆] Siamese version • Duofoil[®] shield ▫ Quad



Multi-conductor and Paired Cable

Less than 25 Conductors

No. of Conductors	Unshielded		Spiral Shield		Braid Shield		Overall Beldfoil®		Overall Foil/Braid		Individual Beldfoil		Individual Braid	
	Part No.	Page	Part No.	Page	Part No.	Page	Part No.	Page	Part No.	Page	Part No.	Page	Part No.	Page
24 AWG (continued)														
9	—	—	—	—	—	—	9539	4.11	9614 9934 83509	4.17 4.18 4.25	—	—	—	—
10	—	—	—	—	—	—	9540 9505 82505 89505 1422A 88105	4.11 5.11 5.13 5.49 5.13 5.49 5.15 5.50	9615 9935 8335 9832 8105	4.17 4.18 5.29 5.30 5.31	8165 [■] 89705	5.44 5.53 19.30	—	—
12	9566 [▼] 24501829	5.4 15.65	—	—	—	—	9506 82506 9682 1423A 88106	5.12 5.13 5.15 5.15 5.50	83512 8336 9839 8106	4.25 5.29 5.30 5.31	9731 89731 9991 8166 [■] 1409R [■] 1511C [■]	5.35 19.29 5.36 5.53 19.30 5.37 5.44 19.18 19.19	1906A	19.20
14	—	—	—	—	—	—	9507	5.12	8337 9833 8107	5.29 5.30 5.31	8167 [■] 89757	5.44 5.53 19.30	—	—
15	—	—	—	—	—	—	9541 88107	4.11 5.50	9616 9936 83515	4.17 4.18 4.25	—	—	—	—
16	1702A ^{◆▼} 1703A ^{◆▼}	15.50 15.50	—	—	—	—	9508 1668A [▼]	5.12 15.69	8108	5.31	8168 [■] 1410R [■] 1512C [■] 1805F [■]	5.45 19.18 19.19 19.28	1908A	19.20
18	—	—	—	—	—	—	9509 82509 9683 88109	5.12 5.13 5.49 5.15 5.50	9834	5.30	9732 89732 9992	5.35 19.29 5.36 5.53 19.30 5.37	—	—
20	9570 [▼]	5.4	—	—	—	—	9542 9510	4.11 5.12	8340 9835 8110	5.29 5.30 5.31	8170 [■]	5.45	—	—
22	—	—	—	—	—	—	—	—	—	—	9733	5.35 19.29	—	—
24	24501837	15.65	—	—	—	—	—	—	9836	5.30	9734 9993 89734 1411R [■] 1513C [■] 1806F [■]	5.35 19.29 5.37 5.53 19.30 19.18 19.19 19.28	1912A	19.20

[▼] Solid conductors
 * Armored
 ■ Individually shielded pairs or triads, plus overall foil, overall braid or overall foil and braid.
 † Triad
[◆] Siamese version
 • Duofoil[®] shield
 • Quad



Multi-conductor and Paired Cable

Less than 25 Conductors

No. of Conductors	Unshielded		Spiral Shield		Braid Shield		Overall Beldfoil®		Overall Foil/Braid		Individual Beldfoil		Individual Braid		
	Part No.	Page	Part No.	Page	Part No.	Page	Part No.	Page	Part No.	Page	Part No.	Page	Part No.	Page	
23 AWG															
8	1872A▼	15.48	—	—	—	—	—	—	—	—	—	—	—	—	
	1874A▼	15.48													
	7813LC	15.53													
	7851A▼	15.46													
	7851NH	15.46													
	7852A▼	15.46													
	7881A▼	15.52													
		21.9													
	7882A▼	15.52													
		21.9													
	7927A	18.11													
	7931A	18.11													
	7989P	15.70													
		19.75													
	7989R	15.70													
		19.75													
	11872A▼	18.11													
	121872A▼	18.11													
24586XXX	15.47														
24588XXX	15.47														
245873XX	15.47														
22 AWG															
1	—	—	—	—	9965	4.15	—	—	—	—	—	—	—	—	
					83305E	4.30									
2	8795▼	4.3	8737	5.24 19.11	9966	4.15	83394	4.29	83552	4.25	—	—	—	—	
	8442	4.3													83319E
		19.35			8422	19.6		19.10	3105A	18.28					
	88442	4.4			8437▼	5.23	9414	5.18	1696A	19.27					
		4.23			8441	5.23	9462	5.18							
		5.6					8761	5.18							
		5.48						19.11							
	82442	4.4					9461	5.18							
		4.23						19.11							
		5.6					8451	5.19							
		5.48						19.10							
	9712	19.32					9451	5.19							
	9151	19.33						19.10							
	8740▼	5.4					1266A	5.19							
	9407	18.42						19.10							
							1503A	5.19							
								19.10							
							88761	5.20							
								5.51							
								19.11							
							87761	5.20							
								5.51							
								19.11							
						82761	5.20								
							5.51								
							19.11								
						9182•	6.88								
						89182•	6.88								
						3077F	18.21								
						3078F	18.21								
						3079E	18.21								
						9322	18.42								
						9451P	5.20								
							19.10								
						9451SB	5.19								
							19.10								

▼ Solid conductors * Armored ■ Individually shielded pairs or triads, plus overall foil, overall braid or overall foil and braid. † Triad
 ◆ Siamese version • Duofoil® shield ▽ Quad



Multi-conductor Cable

Less than 25 Conductors

No. of Conductors	Unshielded		Spiral Shield		Braid Shield		Overall Beldfoil®		Overall Foil/Braid		Individual Beldfoil		Individual Braid	
	Part No.	Page	Part No.	Page	Part No.	Page	Part No.	Page	Part No.	Page	Part No.	Page	Part No.	Page
22 AWG (continued)														
3	8794▼	4.3	—	—	8735	4.14	9770	4.12	9939	4.19	—	—	—	—
	8443	4.3			9967	4.15	8771	4.12	83553	4.25				
	9491†	18.43			83334E	4.30	83395	4.29	3106A	18.28				
							9363†	18.43						
4	9794▼	4.3	—	—	9968	4.15	8729	4.12	9940	4.19	9406	5.38	—	—
	8444	4.3			83349E	4.30	83396	4.29	83554	4.25	8723	5.38		
	88444	4.4					9302▼	5.17	8302	5.32		19.12		
		4.23					9184▼	5.17	9855▼	5.33		21.24		
	82444	4.4					3000A	18.42	1268A▼	5.33	82723	5.38		
		4.23					9512	18.42	89855▼	5.33		5.54		
	8741▼	5.4					9451DP	5.19		5.52		19.12		
	9744	5.5							1269A▼	5.33	8723SB	5.38		
	88741	5.6								5.52		19.12		
		5.48							9696▼	5.33	88723	5.38		
	82741	5.6							89696▼	5.33		5.54		
		5.48								5.52		19.12		
	1242A	4.3						3107A	18.28	87723	5.38			
											5.54			
											19.12			
4 (cont'd)											8728■	5.46		
											9688■▼	15.79		
											82688■▼	15.79		
											1634A■▼	15.79		
											3087A	18.25		
											9328	18.43		
											3001A■	18.43		
											1814R■	19.21		
											1502P	19.39		
											1502R	19.39		
											9451D◆	5.19		
											1504A◆	5.20		
											19.13			
5	8445	4.3	—	—	—	—	—	—	9941	4.19	—	—	—	—
6	9576▼	4.32	—	—	—	—	3002A†	18.43	9942	4.19	3003A†■	18.43		
	8742▼	5.4					9513	18.42	83556	4.25	8767▼	5.37		
	9745	5.5							8303	5.32	8777	5.40		
	82742	5.6							3108A	18.28		19.23		
		5.48									82777	5.41		
											5.54			
											19.24			
											88777	5.41		
											5.54			
											19.24			
											87777	5.41		
											5.54			
											19.24			
											8777SB	5.40		
											19.12			
											9329	18.43		
7	9430	4.3	—	—	—	—	—	—	9943	4.19	—	—	—	—

▼ Solid conductors * Armored ■ Individually shielded pairs or triads, plus overall foil, overall braid or overall foil and braid. † Triad
 ◆ Siamese version ● Duofoil® shield ▸ Quad



Multi-conductor and Paired Cable

Less than 25 Conductors

No. of Conductors	Unshielded		Spiral Shield		Braid Shield		Overall Beldfoil®		Overall Foil/Braid		Individual Beldfoil		Individual Braid	
	Part No.	Page	Part No.	Page	Part No.	Page	Part No.	Page	Part No.	Page	Part No.	Page	Part No.	Page
20 AWG														
1	—	—	—	—	9961 83306E	4.15 4.31	—	—	—	—	—	—	—	—
2	85220 7400A 83930 83932▼ 83934▼ 83915▼ 83900▼ 83905▼ 83910▼ 8649 8205 9408	4.28 18.34 18.55 18.55 18.55 18.55 18.55 18.55 18.55 19.32 5.7 19.35 18.44	8759	5.24 19.13	9962 83320E 8412 8402 9272	4.15 4.31 19.6 19.6 6.87	9802▼ 83393 85230 8762 9464 9154 9320 1033A 3111A 3112A 3113A 83955 83950 83952 83954	4.22 4.29 4.29 5.20 5.20 5.21 19.13 18.44 18.43 18.54 18.54 18.54 18.55 18.55 18.55 18.55	83602 9207● 9463 9463DB 89463 129463* 139463* 189463* 9463F	4.26 6.88 6.87 18.14 18.14 18.14 18.14 18.14 18.14	22671■ 23543*■ 26530*■	18.78 18.80 18.80	—	—
3	7101A 7401A 9492†	18.32 18.34 18.45	—	—	9963 83335E 7401AS 8423 8403	4.15 4.31 18.34 19.7 19.7	8772 9803▼ 85240 9364† 1526A†	4.12 4.22 4.29 18.45 18.45	—	—	22660†■ 23545*†■ 26539*†■	18.78 18.80 18.80	—	—
4	9444 7102A 7402A 8484	4.5 18.32 18.34 4.8	—	—	9964 83350E 7402AS 8424 8404	4.15 4.31 18.34 19.8 19.8	3016A	18.44	83604	4.26	9402 1075A■ 3115A■ 22638■ 23534*■ 26531*■	5.41 18.44 18.54 18.78 18.80 18.80	—	—
5	9445 7403A	4.5 18.34	—	—	7403AS 8405 8425	18.34 19.40 19.40	—	—	—	—	—	—	—	—
6	9750	5.7	—	—	9260 8426	4.14 19.40	3017A†	18.45	83606	4.26	3018A†■ 22662†■ 23546*†■ 26540*†■ 9883 9873	18.45 18.78 18.80 18.80 5.41 5.42	—	—
7	9439 7404A	4.5 18.34	—	—	7404AS 8427	18.34 19.40	—	—	—	—	—	—	—	—
8	—	—	—	—	8418 9892	19.40 15.76	85164 1056A	5.11 18.44	—	—	8725 9891■ 9901●■ 89901●■ 89892■ 1076A■ 1006A■ 1012A■ 22639■ 23514*■ 26532*■	5.47 15.76 15.75 15.75 15.76 18.44 18.54 18.54 18.78 18.80 18.80	—	—
9	9455 7105A 7405A	4.5 18.32 18.34	—	—	—	—	—	—	83609	4.26	—	—	—	—
10	—	—	—	—	—	—	9890▼	4.22	—	—	9902●■	15.75	—	—

▼ Solid conductors * Armored ■ Individually shielded pairs or triads, plus overall foil, overall braid or overall foil and braid. † Triad
 ● Siamese version ● Duofoil® shield ■ Quad

Multi-conductor and Paired Cable

Less than 25 Conductors

No. of Conductors	Unshielded		Spiral Shield		Braid Shield		Overall Beldfoil®		Overall Foil/Braid		Individual Beldfoil		Individual Braid	
	Part No.	Page	Part No.	Page	Part No.	Page	Part No.	Page	Part No.	Page	Part No.	Page	Part No.	Page
20 AWG (continued)														
12	9457	4.5	—	—	9261	4.14	3020A†	18.45	83612	4.26	1083A†■	18.45	—	—
	7106A	18.32	—	—	7106AS	18.32	—	—	—	—	22663†■	18.78	—	—
	7406A	18.34	—	—	—	—	—	—	—	—	23547*†■	18.80	—	—
	9751	5.7	—	—	—	—	—	—	—	—	26541*†■	18.80	—	—
	—	—	—	—	—	—	—	—	—	—	—	9886	5.41	—
15	9458	4.5	—	—	—	—	9894▼	4.22	—	—	9874	5.42	—	—
16	—	—	—	—	—	—	85168	5.11	—	—	22640■	18.78	—	—
	—	—	—	—	—	—	1057A	18.44	—	—	23513*■	18.80	—	—
	—	—	—	—	—	—	—	—	—	—	26533*■	18.80	—	—
	—	—	—	—	—	—	—	—	—	—	9875	5.42	—	—
	—	—	—	—	—	—	—	—	—	—	—	—	—	—
18	7107A	18.32	—	—	—	—	—	—	—	—	—	—	—	—
	7407A	18.34	—	—	—	—	—	—	—	—	—	—	—	—
	9752	5.7	—	—	—	—	—	—	—	—	—	—	—	—
22	—	—	—	—	—	—	—	—	—	9876	5.42	—	—	
24	—	—	—	—	—	—	3021A†	18.45	—	—	1084A†■	18.45	—	—
	—	—	—	—	—	—	1058A	18.44	—	—	22672†■	18.78	—	—
	—	—	—	—	—	—	—	—	—	—	23548*†■	18.80	—	—
	—	—	—	—	—	—	—	—	—	—	26542*†■	18.80	—	—
	—	—	—	—	—	—	—	—	—	—	9877	5.42	—	—
	—	—	—	—	—	—	—	—	—	—	1078A■	18.44	—	—
	—	—	—	—	—	—	—	—	—	—	1014A■	18.54	—	—
—	—	—	—	—	—	—	—	—	—	22676■	18.78	—	—	
—	—	—	—	—	—	—	—	—	—	23521*■	18.80	—	—	
—	—	—	—	—	—	—	—	—	—	26535*■	18.80	—	—	—
19 AWG														
2	8486	5.7	—	—	—	—	—	—	—	—	—	—	—	—
18 AWG														
1	—	—	—	—	83307E	4.31	—	—	—	—	—	—	—	—
2	9571▼	4.32	8790	5.24 19.14	83321E	4.31	27325AS	18.64	83652	4.26	22645■	18.78	—	—
	7409A	18.35			8428	19.6	9574▼	4.32	3072F	18.18	23533*■	18.80	—	—
	27916A	18.64			9250	6.87	8760	5.21	3073F	18.18	26514*■	18.80	—	—
	27325A	18.64			8208	5.23	—	—	3074F	18.18	22417■	18.82	—	—
	9708	19.32			—	—	9460	5.21	—	—	24511*■	18.83	—	—
	8460	19.33			—	—	—	—	—	—	25506*■	18.83	—	—
	1863A	19.33			—	—	88760	5.21	—	—	—	—	—	—
	8461	5.7			—	—	—	5.51	—	—	—	—	—	—
	—	19.35			—	—	—	19.14	—	—	—	—	—	—
	29030*	18.88			—	—	87760	5.21	—	—	—	—	—	—
	9740	5.8	—	—	—	5.51	—	—	—	—	—	—		
	89740	5.9	—	—	—	19.15	—	—	—	—	—	—		
	—	5.48	—	—	82760	5.21	—	—	—	—	—	—		
	87740	5.9	—	—	—	5.51	—	—	—	—	—	—		
	—	5.48	—	—	—	19.14	—	—	—	—	—	—		
	82740	5.9	—	—	—	—	3076F	18.19	—	—	—	—		
	—	5.48	—	—	—	—	9318	18.46	—	—	—	—		
	9409	18.46	—	—	—	—	1032A	18.47	—	—	—	—		
	9486	18.57	—	—	—	—	9341	18.57	—	—	—	—		
	—	—	—	—	—	—	1120A	18.57	—	—	—	—		
	—	—	—	—	—	—	3088A	18.57	—	—	—	—		
—	—	—	—	—	—	3088AE	18.58	—	—	—	—			
—	—	—	—	—	—	3088CE	18.58	—	—	—	—			

▼ Solid conductors * Armored ■ Individually shielded pairs or triads, plus overall foil, overall braid or overall foil and braid. † Triad
 ◆ Siamese version ● Duofoil® shield ▫ Quad



Multi-conductor and Paired Cable

Less than 25 Conductors

No. of Conductors	Unshielded		Spiral Shield		Braid Shield		Overall Beldfoil®		Overall Foil/Braid		Individual Beldfoil		Individual Braid	
	Part No.	Page	Part No.	Page	Part No.	Page	Part No.	Page	Part No.	Page	Part No.	Page	Part No.	Page
18 AWG (continued)														
3	7110A	18.32	8791	4.14	83336E	4.31	27334AS	18.63	83653	4.26	22677†▪	18.78	—	—
	7410A	18.35					8770	4.13			23505*†▪	18.80		
	9493†	18.48					88770	4.13			26522*†▪	18.80		
	27334A	18.64						4.24			22442†▪	18.82		
	29031*	18.88					9365†	18.48			24516*†▪	18.83		
							1036A†	18.48			25500*†▪	18.83		
							1121A†	18.58			3088AE	18.58		
							3089A†	18.58			3088CE	18.58		
4	8489	4.5	—	—	83351E	4.31	27326AS	18.64	83654	4.26	9368	18.46	—	—
	88489	4.6			7111AS	18.32	9418	4.13			1474A▪	18.47		
		4.23			7411AS	18.35	89418	4.13			1048A▪	18.57		
	82489	4.6						4.24			22633▪	18.78		
		4.23					82418	4.13			23511*▪	18.80		
	7411A	18.35						4.24			26515*▪	18.80		
	27326A	18.64					9578▼	4.32			22405▪	18.82		
	29032*	18.88					9552	18.46			24512*▪	18.83		
	9156	5.8					3025A	18.47			25514*▪	18.83		
							1063A	18.57						
5	8465	4.5	—	—	—	—	—	—	—	—	—	—	—	—
	7412A	18.35												
	27335A	18.64												
	29033*	18.88												
6	27600A	18.64	—	—	—	—	3027A†	18.47	83656	4.26	3028A†▪	18.48	—	—
	29034*	18.88					9553	18.46			3064A†▪	18.58		
	8690	5.8					1529A	18.47			22678†▪	18.78		
											23516*†▪	18.80		
											26523*†▪	18.80		
7	8467	4.5	—	—	7413AS	18.35	—	—	—	—	—	—	—	—
	7113A	18.32												
	7413A	18.35												
	27327A	18.64												
	29035*	18.88												
8	27601A	18.64	—	—	—	—	9554	18.46	—	—	3029A	18.46	—	—
	29036*	18.88					1466A	18.47			9388	18.46		
	9157	5.8					1064A	18.57			1475A▪	18.47		
											1049A▪	18.57		
											22648▪	18.78		
9	8469	4.5	—	—	—	—	—	—	83659	4.26	—	—	—	—
	7414A	18.35												
	27336A	18.64												
10	27328A	18.64	—	—	—	—	—	—	—	—	—	—	—	—
	29038*	18.88												
	9159	5.8												
11	27602A	18.64	—	—	—	—	—	—	—	—	—	—	—	—

▼ Solid conductors * Armored ▪ Individually shielded pairs or triads, plus overall foil, overall braid or overall foil and braid. † Triad
 ♦ Siamese version • Duofoil® shield ▫ Quad



Multi-conductor and Paired Cable

Less than 25 Conductors

No. of Conductors	Unshielded		Spiral Shield		Braid Shield		Overall Beldfoil®		Overall Foil/Braid		Individual Beldfoil		Individual Braid	
	Part No.	Page	Part No.	Page	Part No.	Page	Part No.	Page	Part No.	Page	Part No.	Page	Part No.	Page
18 AWG (continued)														
12	8466	4.5	—	—	7115AS	18.32	3030A†	18.48	83662	4.26	3031A†	18.48	—	—
	7115A	18.32	—	—	7415AS	18.35	9556	18.46			1093A†	18.58	—	—
	7415A	18.35	—	—	—	—	—	—			22679†	18.78	—	—
	27329A	18.64	—	—	—	—	—	—			23515*†	18.80	—	—
	29040*	18.88	—	—	—	—	—	—			26524*†	18.80	—	—
	8691	5.8	—	—	—	—	—	—			22444†	18.82	—	—
	—	—	—	—	—	—	—	—			24518*†	18.83	—	—
	—	—	—	—	—	—	—	—			25520*†	18.83	—	—
13	27603A	18.64	—	—	—	—	—	—	—	—	—	—	—	
14	27604A	18.64	—	—	—	—	—	—	—	—	—	—	—	
15	8468	4.5	—	—	—	—	—	—	—	—	—	—	—	
	27605A	18.64	—	—	—	—	—	—	—	—	—	—	—	
	29043*	18.88	—	—	—	—	—	—	—	—	—	—	—	
16	27606A	18.64	—	—	—	—	1467A	18.47	—	—	1476A	18.47	—	—
	9161	5.8	—	—	—	—	1065A	18.57	—	—	1050A	18.57	—	—
	—	—	—	—	—	—	—	—	—	—	22635	18.78	—	—
	—	—	—	—	—	—	—	—	—	—	23531**	18.80	—	—
	—	—	—	—	—	—	—	—	—	—	26518**	18.80	—	—
	—	—	—	—	—	—	—	—	—	—	22418	18.82	—	—
17	27607A	18.64	—	—	—	—	—	—	—	—	24514**	18.83	—	—
18	7116A	18.32	—	—	7416AS	18.35	9559	18.46	—	—	23508*†	18.80	—	—
	7416A	18.35	—	—	—	—	—	—	—	—	26525*†	18.80	—	—
	27608A	18.64	—	—	—	—	—	—	—	—	9775	5.42	—	—
	8692	5.8	—	—	—	—	—	—	—	—	9390	18.46	—	—
19	8619	4.6	—	—	—	—	—	—	—	—	—	—	—	—
	27609A	18.64	—	—	—	—	—	—	—	—	—	—	—	—
20	27610A	18.64	—	—	—	—	—	—	—	—	—	—	—	—
	29048*	18.88	—	—	—	—	—	—	—	—	—	—	—	—
22	—	—	—	—	—	—	9563	18.46	—	—	9391	18.46	—	—
24	9741	5.8	—	—	—	—	3032A†	18.48	—	—	3033A†	18.48	—	—
							1468A	18.47			1094A†	18.58		
							1066A	18.57			22680†	18.78		
							—	—			23523*†	18.80		
							—	—			26526*†	18.80		
							—	—			22445†	18.82		
							—	—			24519*†	18.83		
							—	—			25523*†	18.83		
							—	—			9776	5.42		
							—	—			1477A	18.57		
							—	—			1051A	18.57		
							—	—			22636	18.78		
							—	—			23524**	18.80		
							—	—			26519**	18.80		
—	—	22421	18.82											
—	—	24515**	18.83											
—	—	25501**	18.83											

▼ Solid conductors * Armored ■ Individually shielded pairs or triads, plus overall foil, overall braid or overall foil and braid. † Triad
 ◆ Siamese version • Duofoil® shield ▫ Quad



Multi-conductor and Paired Cable

Less than 25 Conductors

No. of Conductors	Unshielded		Spiral Shield		Braid Shield		Overall Beldfoil®		Overall Foil/Braid		Individual Beldfoil		Individual Braid	
	Part No.	Page	Part No.	Page	Part No.	Page	Part No.	Page	Part No.	Page	Part No.	Page	Part No.	Page
16 AWG														
1	—	—	—	—	9951 83308E	4.15 4.31	—	—	—	—	—	—	—	—
2	8677 85221 85102 9572▼ 7421A 27917A 27337A 9716 8470 9497 1862A 8471 29017* 9410 1035A 9487 1307A	4.8 4.28 4.28 4.32 18.36 18.65 18.65 19.32 21.23 19.33 19.33 19.33 5.9 19.35 18.88 18.49 18.49 18.59 19.36 21.20	8780	5.24 19.15	9952 83322E 8408	4.15 4.31 19.6	85231 9575▼ 27337AS 8719 9316 1030A 1101A 1000A 1018A 1023A 1114A▼ 1115A▼ 1116A▼ 1117A▼ 83951 83953 9342 1118A 3090A 3090AE 3090CE	4.29 4.32 18.65 5.22 19.15 18.49 18.49 18.54 18.54 18.54 18.54 18.55 18.55 18.55 18.55 18.55 18.59 18.59 18.59 18.60 18.60	83702 9860●▼	4.27 6.88	22646■ 23501*■ 26500*■ 22416■ 24500*■ 25504*■	18.79 18.81 18.81 18.82 18.83 18.83	—	—
3	9498 85103 7122A 7422A 9494† 1034A† 27331A 29004*	4.6 4.28 18.33 18.36 18.50 18.49 18.65 18.88	—	—	9953 83337E	4.15 4.31	8618 85241 9366† 1031A† 1119A† 3091A† 27331AS	4.13 4.29 18.50 18.50 18.60 18.60 18.65	83703	4.27	22603†■ 23507*†■ 26502*†■ 22413†■ 24501*†■ 25502*†■	18.79 18.81 18.81 18.82 18.83 18.83	—	—
4	8620 7423A 27338A 29018* 3082K 3082KP 1308A	4.6 18.36 18.65 18.88 18.24 18.24 19.36 21.20	—	—	9954 83352E 7123AS 7423AS 8407	4.15 4.31 18.33 18.36 19.8	9579▼ 3043A 1069A	4.32 18.49 18.59	83704 29500	4.27 18.30	1492A■ 1055A■ 22628■ 23527*■ 26501*■ 22409■ 24505*■ 25510*■	18.49 18.59 18.79 18.81 18.81 18.82 18.83 18.83	—	—
5	9620 9420 85105 7424A 27339A 29019*	4.6 4.9 9.10 4.28 18.36 18.65 18.88	—	—	—	—	—	—	—	—	—	—	—	—
6	27615A 29005*	18.65 18.88	—	—	—	—	3044A† 1528A 1527A	18.50 18.49 18.59	83706	4.27	3045A†■ 22687†■ 23522*†■ 26509*†■ 22448†■ 24507*†■ 25507*†■ 1037A■	18.50 18.79 18.81 18.81 18.82 18.83 18.83 18.59	—	—
7	8621 9422 85107 7125A 7425A 27323A 29020*	4.6 4.9 9.10 4.28 18.33 18.36 18.65 18.88	—	—	—	—	—	—	—	—	—	—	—	—

▼ Solid conductors * Armored ■ Individually shielded pairs or triads, plus overall foil, overall braid or overall foil and braid. † Triad
 ● Siamese version ● Duofoil® shield † Triad ▽ Quad



Multi-conductor and Paired Cable

Less than 25 Conductors

No. of Conductors	Unshielded		Spiral Shield		Braid Shield		Overall Beldfoil®		Overall Foil/Braid		Individual Beldfoil		Individual Braid	
	Part No.	Page	Part No.	Page	Part No.	Page	Part No.	Page	Part No.	Page	Part No.	Page	Part No.	Page
16 AWG (continued)														
8	9721	4.6	—	—	—	—	1484A	18.49	—	—	1493A [■]	18.49	—	—
	27616A	18.65	—	—	—	—	1070A	18.59	—	—	1039A [■]	18.59	—	—
	29021*	18.88	—	—	—	—	—	—	—	—	22629 [■]	18.79	—	—
	—	—	—	—	—	—	—	—	—	—	23509 ^{*■}	18.81	—	—
9	9621	4.6	—	—	—	—	—	—	83709	4.27	—	—	—	—
	9424	4.9	—	—	—	—	—	—	—	—	—	—	—	—
	—	9.10	—	—	—	—	—	—	—	—	—	—	—	—
	85109	4.28	—	—	—	—	—	—	—	—	—	—	—	—
	7126A	18.33	—	—	—	—	—	—	—	—	—	—	—	—
10	27617A	18.65	—	—	—	—	—	—	—	—	—	—	—	—
	29022*	18.88	—	—	—	—	—	—	—	—	—	—	—	—
11	27618A	18.65	—	—	—	—	—	—	—	—	—	—	—	—
12	8622	4.6	—	—	7427AS	18.36	3046A [†]	18.50	83712	4.27	3047A ^{†■}	18.50	—	—
	9425	4.9	—	—	—	—	—	—	—	—	1097A ^{†■}	18.60	—	—
	—	9.10	—	—	—	—	—	—	—	—	22675 ^{†■}	18.79	—	—
	7127A	18.33	—	—	—	—	—	—	—	—	23520 ^{*†■}	18.81	—	—
	7427A	18.36	—	—	—	—	—	—	—	—	26510 ^{*†■}	18.81	—	—
	27341A	18.65	—	—	—	—	—	—	—	—	22414 ^{†■}	18.82	—	—
	29006*	18.88	—	—	—	—	—	—	—	—	24508 ^{*†■}	18.83	—	—
	—	—	—	—	—	—	—	—	—	—	25509 ^{*†■}	18.83	—	—
13	27619A	18.65	—	—	—	—	—	—	—	—	1040A [■]	18.59	—	—
	—	—	—	—	—	—	—	—	—	—	22630 [■]	18.79	—	—
14	27620A	18.65	—	—	—	—	—	—	—	—	23500 ^{*■}	18.81	—	—
15	8623	4.6	—	—	—	—	—	—	83715	4.27	26504 ^{*■}	18.81	—	—
	27621A	18.65	—	—	—	—	—	—	—	—	22446 [■]	18.82	—	—
	29023*	18.88	—	—	—	—	—	—	—	—	24506 ^{*■}	18.83	—	—
16	9427	4.9	—	—	—	—	1485A	18.49	—	—	1494A [■]	18.49	—	—
	—	9.10	—	—	—	—	1071A	18.59	—	—	1041A [■]	18.59	—	—
	27330A	18.65	—	—	—	—	—	—	—	—	22631 [■]	18.79	—	—
	—	—	—	—	—	—	—	—	—	—	23510 ^{*■}	18.81	—	—
17	27622A	18.65	—	—	—	—	—	—	—	—	26505 ^{*■}	18.81	—	—
	—	—	—	—	—	—	—	—	—	—	22411 [■]	18.82	—	—
18	7128A	18.33	—	—	7428AS	18.36	—	—	—	—	24503 ^{*■}	18.83	—	—
	7428A	18.36	—	—	—	—	—	—	—	—	25513 ^{*■}	18.83	—	—
	27623A	18.65	—	—	—	—	—	—	—	—	—	—	—	—
19	8624	4.6	—	—	—	—	—	—	83719	4.27	—	—	—	—
20	9429	4.9	—	—	—	—	—	—	—	—	—	—	—	—
	27625A	18.65	—	—	—	—	—	—	—	—	—	—	—	—
—	29007*	18.88	—	—	—	—	—	—	—	—	—	—	—	—

▼ Solid conductors * Armored ■ Individually shielded pairs or triads, plus overall foil, overall braid or overall foil and braid. † Triad
 ◆ Siamese version ● Duofoil® shield ▸ Quad



Multi-conductor and Paired Cable

Less than 25 Conductors

No. of Conductors	Unshielded		Spiral Shield		Braid Shield		Overall Beldfoil®		Overall Foil/Braid		Individual Beldfoil		Individual Braid	
	Part No.	Page	Part No.	Page	Part No.	Page	Part No.	Page	Part No.	Page	Part No.	Page	Part No.	Page
16 AWG (continued)														
24	—	—	—	—	—	—	3048A† 1486A 1072A	18.50 18.49 18.59	—	—	3049A†▪ 1098A†▪ 22689†▪ 23526*†▪ 26512*†▪ 22415†▪ 24509*†▪ 25508*†▪ 1495A▪ 1042A▪ 22632▪ 23525*▪ 26506*▪ 22412▪ 24504*▪ 25518*▪	18.50 18.60 18.79 18.81 18.81 18.82 18.83 18.83 18.49 18.59 18.79 18.81 18.81 18.82 18.83	—	—
14 AWG														
2	8675 9580▼ 7434A 27080A 27636A 9717 1861A 8473 27243* 28243* 27840* 28840* 22100 C5500* 9411 9488 1309A	4.8 4.33 18.37 18.65 18.66 19.32 21.23 19.34 5.9 19.35 18.71 18.71 18.74 18.74 18.85 18.89 18.51 18.61 19.36 21.20	—	—	—	—	9581▼ 8720 9314 9343 3080A	4.33 5.22 19.15 18.51 18.61 18.61	83752	4.34	—	—	—	—
3	7435A 9495† 27081A 27244* 28244* 27841* 28841* 22101 C5501* C5701*	18.37 18.51 18.66 18.71 18.71 18.74 18.74 18.85 18.89 18.92	—	—	—	—	9367† 3081A† 27081AS	18.51 18.61 18.66	83753	4.34	—	—	—	—
4	8627 7136A 7436A 27082A 1810A 27245* 28245* 27842* 28842* 22102 C5502* C5702* 1310A	4.7 18.33 18.37 18.66 19.37 18.71 18.71 18.74 18.74 18.85 18.89 18.92 19.36 21.20	—	—	7136AS 7436AS	18.33 18.37	27082AS	18.66	83754 29501	4.34 18.30	—	—	—	—

▼ Solid conductors * Armored ▪ Individually shielded pairs or triads, plus overall foil, overall braid or overall foil and braid. † Triad
 ♦ Siamese version • Duofoil® shield ▫ Quad



Multi-conductor and Paired Cable

Less than 25 Conductors

No. of Conductors	Unshielded		Spiral Shield		Braid Shield		Overall Beldfoil®		Overall Foil/Braid		Individual Beldfoil		Individual Braid	
	Part No.	Page	Part No.	Page	Part No.	Page	Part No.	Page	Part No.	Page	Part No.	Page	Part No.	Page
14 AWG (continued)														
5	9623	4.7	—	—	—	—	—	—	—	—	—	—	—	—
	27083A	18.66												
	27246*	18.71												
	28246*	18.71												
	27843*	18.74												
	28843*	18.74												
	22103	18.85												
C5503*	18.89													
6	27084A	18.66	—	—	—	—	—	—	83756	4.34	—	—	—	—
	27247*	18.71												
	28247*	18.71												
	27844*	18.74												
	28844*	18.74												
	22104	18.85												
	C5504*	18.89												
7	8628	4.7	—	—	7438AS	18.36	—	—	—	—	—	—	—	—
	7438A	18.37												
	27085A	18.66												
	27248*	18.71												
	28248*	18.71												
	27845*	18.74												
	28845*	18.74												
22105	18.85													
C5505*	18.89													
8	27086A	18.66	—	—	—	—	—	—	—	—	—	—	—	—
	1811A	19.37												
	27269*	18.71												
	28269*	18.71												
	27846*	18.74												
	28846*	18.74												
	22106	18.85												
C5506*	18.89													
9	7439A	18.37	—	—	—	—	—	—	—	—	—	—	—	—
	27087A	18.66												
	27535*	18.71												
	28535*	18.71												
22107	18.85													
10	27088A	18.66	—	—	—	—	—	—	—	—	—	—	—	—
	27249*	18.71												
	28249*	18.71												
	27847*	18.74												
	28847*	18.74												
	22108	18.85												
C5508*	18.89													
11	27089A	18.66	—	—	—	—	—	—	—	—	—	—	—	—
12	8629	4.7	—	—	—	—	—	—	—	—	—	—	—	—
	7440A	18.37												
	27090A	18.66												
	27250*	18.71												
	28250*	18.71												
	27848*	18.74												
	28848*	18.74												
	22110	18.85												
C5510*	18.89													
13	27091A	18.66	—	—	—	—	—	—	—	—	—	—	—	—
14	27092A	18.66	—	—	—	—	—	—	—	—	—	—	—	—
15	27093A	18.66	—	—	—	—	—	—	—	—	—	—	—	—
	27251*	18.71												
	28251*	18.71												
	27849*	18.74												
	28849*	18.74												
C5513*	18.89													

2 • Cable Finder Guide

▼ Solid conductors * Armored ■ Individually shielded pairs or triads, plus overall foil, overall braid or overall foil and braid. † Triad
 ◆ Siamese version ● Duofoil® shield ▴ Quad



Multi-conductor and Paired Cable

Less than 25 Conductors

No. of Conductors	Unshielded		Spiral Shield		Braid Shield		Overall Beldfoil®		Overall Foil/Braid		Individual Beldfoil		Individual Braid			
	Part No.	Page	Part No.	Page	Part No.	Page	Part No.	Page	Part No.	Page	Part No.	Page	Part No.	Page		
14 AWG (continued)																
16	27094A	18.66	—	—	—	—	—	—	—	—	—	—	—	—		
	22114	18.85														
17	27095A	18.66	—	—	—	—	—	—	—	—	—	—	—	—		
18	27096A	18.66	—	—	—	—	—	—	—	—	—	—	—	—		
19	27097A	18.66	—	—	—	—	—	—	—	—	—	—	—	—		
	27969*	18.71														
	28969*	18.71														
20	27098A	18.66	—	—	—	—	—	—	—	—	—	—	—	—		
	27252*	18.71														
	28252*	18.71														
	27850*	18.74														
	28850*	18.74														
	22118	18.85														
C5518*	18.89															
21	27099A	18.66	—	—	—	—	—	—	—	—	—	—	—	—		
22	27100A	18.66	—	—	—	—	—	—	—	—	—	—	—	—		
23	27101A	18.66	—	—	—	—	—	—	—	—	—	—	—	—		
24	27102A	18.66	—	—	—	—	—	—	—	—	—	—	—	—		
12 AWG																
2	8673	4.8	—	—	—	—	9583▼	4.33	83802	4.34	—	—	—	—		
	9582*	4.33					8718	5.22								
	27109A	18.67						19.15								
	27641A	18.67					9312	18.52								
	9718	19.32					9344	18.62								
		21.23					3103A	18.62								
	1860A	19.34														
	8477	5.9														
		19.35														
	27254*	18.71														
	28254*	18.71														
	27853*	18.74														
	28853*	18.74														
	22120	18.85														
	C5530*	18.89														
	C5730*	18.92														
	9412	18.52														
9489	18.62															
1311A	19.36															
	21.20															
3	7444A	18.37	—	—	—	—	3102A†	18.52	83803	4.34	—	—	—	—		
	27110A	18.67					3104A†	18.62								
	27255*	18.71														
	28255*	18.71														
	27854*	18.74														
	28854*	18.74														
	22121	18.85														
	C5531*	18.89														
C5731*	18.92															
4	7145A	18.33	—	—	7445AS	18.37	—	—	83804	4.34	—	—	—	—		
	7445A	18.37									29502	18.30				
	27111A	18.67														
	27256*	18.71														
	28256*	18.71														
	27855*	18.74														
	28855*	18.74														
	22122	18.85														
	C5532*	18.89														
	C5732*	18.92														
	1312A	19.36														
	21.20															

▼ Solid conductors
◆ Siamese version

* Armored
● Duofoil® shield

■ Individually shielded pairs or triads, plus overall foil, overall braid or overall foil and braid.

† Triad
‡ Quad



Multi-conductor and Paired Cable

Less than 25 Conductors

No. of Conductors	Unshielded		Spiral Shield		Braid Shield		Overall Beldfoil®		Overall Foil/Braid		Individual Beldfoil		Individual Braid	
	Part No.	Page	Part No.	Page	Part No.	Page	Part No.	Page	Part No.	Page	Part No.	Page	Part No.	Page
12 AWG (continued)														
5	27112A	18.67	—	—	—	—	—	—	—	—	—	—	—	—
	27271*	18.71												
	28271*	18.71												
	27856*	18.74												
	28856*	18.74												
	22123	18.85												
	C5533*	18.89												
6	27113A	18.67	—	—	—	—	—	—	83806	4.34	—	—	—	—
	27272*	18.71												
	28272*	18.71												
	27857*	18.74												
	28857*	18.74												
	22124	18.85												
	C5534*	18.89												
7	27114A	18.67	—	—	—	—	—	—	—	—	—	—	—	—
	27273*	18.71												
	28273*	18.71												
	27858*	18.74												
	28858*	18.74												
	22125	18.85												
	C5535*	18.89												
8	27115A	18.67	—	—	—	—	—	—	—	—	—	—	—	—
	27274*	18.71												
	28274*	18.71												
	27859*	18.74												
	28859*	18.74												
	22126	18.85												
	C5536*	18.89												
9	27116A	18.67	—	—	—	—	—	—	—	—	—	—	—	—
	27538*	18.71												
	28538*	18.71												
	22127	18.85												
10	27117A	18.67	—	—	—	—	—	—	—	—	—	—	—	—
	27275*	18.71												
	28275*	18.71												
	27860*	18.74												
	28860*	18.74												
	22128	18.85												
	C5538*	18.89												
11	27118A	18.67	—	—	—	—	—	—	—	—	—	—	—	—
12	27119A	18.67	—	—	—	—	—	—	—	—	—	—	—	—
	27276*	18.71												
	28276*	18.71												
	27861*	18.74												
	28861*	18.74												
	22130	18.85												
	C5540*	18.89												
13	27120A	18.67	—	—	—	—	—	—	—	—	—	—	—	—
14	27121A	18.67	—	—	—	—	—	—	—	—	—	—	—	—
15	27122A	18.67	—	—	—	—	—	—	—	—	—	—	—	—
	27277*	18.71												
	28277*	18.71												
	27862*	18.74												
	28862*	18.74												
	C5543*	18.89												
16	27123A	18.67	—	—	—	—	—	—	—	—	—	—	—	—
	22134	18.85												
17	27124A	18.67	—	—	—	—	—	—	—	—	—	—	—	—
18	27125A	18.67	—	—	—	—	—	—	—	—	—	—	—	—

▼ Solid conductors * Armored ■ Individually shielded pairs or triads, plus overall foil, overall braid or overall foil and braid. † Triad
 ◆ Siamese version ● Duofoil® shield ▸ Quad



Multi-conductor and Paired Cable

Less than 25 Conductors

No. of Conductors	Unshielded		Spiral Shield		Braid Shield		Overall Beldfoil®		Overall Foil/Braid		Individual Beldfoil		Individual Braid	
	Part No.	Page	Part No.	Page	Part No.	Page	Part No.	Page	Part No.	Page	Part No.	Page	Part No.	Page
12 AWG (continued)														
19	27126A	18.67	—	—	—	—	—	—	—	—	—	—	—	—
	27539*	18.71												
	28539*	18.71												
20	27127A	18.67	—	—	—	—	—	—	—	—	—	—	—	—
	27278*	18.71												
	28278*	18.71												
	27863*	18.74												
	28863*	18.74												
	22138	18.85												
C5548*	18.89													
21	27128A	18.67	—	—	—	—	—	—	—	—	—	—	—	—
22	27129A	18.67	—	—	—	—	—	—	—	—	—	—	—	—
23	27130A	18.67	—	—	—	—	—	—	—	—	—	—	—	—
24	27131A	18.67	—	—	—	—	—	—	—	—	—	—	—	—
10 AWG														
2	8678	4.8	—	—	—	—	—	—	—	—	—	—	—	—
	27138A	18.68												
	27643A	18.68												
	27257*	18.72												
	28257*	18.72												
	27866*	18.75												
	28866*	18.75												
	22140	18.85												
	C5560*	18.90												
	C5760*	18.92												
	1313A	19.36												
		21.20												
3	27139A	18.68	—	—	—	—	—	—	—	—	—	—	—	—
	27258*	18.72												
	28258*	18.72												
	27867*	18.75												
	28867*	18.75												
	22141	18.85												
C5561*	18.90													
C5761*	18.92													
4	7447A	18.38	—	—	7447AS	18.38	—	—	29503	18.30	—	—	—	—
	27140A	18.68												
	27259*	18.72												
	28259*	18.72												
	27868*	18.75												
	28868*	18.75												
	22142	18.85												
	C5562*	18.90												
C5762*	18.92													
5	27141A	18.68	—	—	—	—	—	—	—	—	—	—	—	—
	27281*	18.72												
	28281*	18.72												
	27869*	18.75												
	28869*	18.75												
22143	18.85													
C5563*	18.90													
6	27142A	18.68	—	—	—	—	—	—	—	—	—	—	—	—
	27282*	18.72												
	28282*	18.72												
	27870*	18.75												
	28870*	18.75												
	22144	18.85												
C5564*	18.90													

▼ Solid conductors
◆ Siamese version

* Armored
● Duofoil® shield

■ Individually shielded pairs or triads, plus overall foil, overall braid or overall foil and braid.

† Triad
▴ Quad



Multi-conductor and Paired Cable

Less than 25 Conductors

No. of Conductors	Unshielded		Spiral Shield		Braid Shield		Overall Beldfoil®		Overall Foil/Braid		Individual Beldfoil		Individual Braid	
	Part No.	Page	Part No.	Page	Part No.	Page	Part No.	Page	Part No.	Page	Part No.	Page	Part No.	Page
10 AWG (continued)														
7	27143A	18.68	—	—	—	—	—	—	—	—	—	—	—	—
	27283*	18.72												
	28283*	18.72												
	27877*	18.75												
	28877*	18.75												
	22145	18.85												
	C5565*	18.90												
8	27144A	18.68	—	—	—	—	—	—	—	—	—	—	—	—
	27284*	18.72												
	28284*	18.72												
	27878*	18.75												
	28878*	18.75												
	22146	18.85												
	C5566*	18.90												
9	27145A	18.68	—	—	—	—	—	—	—	—	—	—	—	—
	27541*	18.72												
	28541*	18.72												
	22147	18.85												
10	27146A	18.68	—	—	—	—	—	—	—	—	—	—	—	—
	27285*	18.72												
	28285*	18.72												
	27879*	18.75												
	28879*	18.75												
	22148	18.85												
	C5568*	18.90												
11	27147A	18.68	—	—	—	—	—	—	—	—	—	—	—	—
12	27148A	18.68	—	—	—	—	—	—	—	—	—	—	—	—
	27286*	18.72												
	28286*	18.72												
	27880*	18.75												
	28880*	18.75												
	22150	18.85												
	C5570*	18.90												
14	22152	18.85	—	—	—	—	—	—	—	—	—	—	—	—
15	27287*	18.72	—	—	—	—	—	—	—	—	—	—	—	—
	28287*	18.72												
	27881*	18.75												
	28881*	18.75												
	C5573*	18.90												
16	22154	18.85	—	—	—	—	—	—	—	—	—	—	—	—
20	27288*	18.72	—	—	—	—	—	—	—	—	—	—	—	—
	28288*	18.72												
	27882*	18.75												
	28882*	18.75												
	C5578*	18.90												

▼ Solid conductors * Armored ■ Individually shielded pairs or triads, plus overall foil, overall braid or overall foil and braid. † Triad
 ◆ Siamese version ● Duofoil® shield ▸ Quad



Multi-conductor and Paired Cable

Less than 25 Conductors

No. of Conductors	Unshielded		Spiral Shield		Braid Shield		Overall Beldfoil®		Overall Foil/Braid		Individual Beldfoil		Individual Braid	
	Part No.	Page	Part No.	Page	Part No.	Page	Part No.	Page	Part No.	Page	Part No.	Page	Part No.	Page
8 AWG														
2	27149A	18.68	—	—	—	—	—	—	—	—	—	—	—	—
	27291*	18.72												
	28291*	18.72												
	27871*	18.75												
	28871*	18.75												
	22160	18.86												
	C5583*	18.90												
		18.92												
3	27150A	18.68	—	—	—	—	—	—	—	—	—	—	—	—
	27260*	18.72												
	28260*	18.72												
	27872*	18.75												
	28872*	18.75												
	22161	18.86												
	C5581*	18.90												
		18.92												
4	7450A	18.38	—	—	7450AS	18.37	—	—	29504	18.28	—	—	—	—
	27151A	18.68												
	27261*	18.72												
	28261*	18.72												
	27873*	18.75												
	28873*	18.75												
	22162	18.86												
C5582*	18.90													
		18.92												
6 AWG														
2	27152A	18.68	—	—	—	—	—	—	—	—	—	—	—	—
	27293*	18.72												
	28293*	18.72												
	27874*	18.75												
	28874*	18.75												
	22170	18.86												
	C5590*	18.93												
3	27153A	18.68	—	—	—	—	—	—	—	—	—	—	—	—
	27262*	18.72												
	28262*	18.72												
	27875*	18.75												
	28875*	18.75												
	22171	18.86												
	C5591*	18.93												
4	7453A	18.38	—	—	—	—	—	—	29505	18.28	—	—	—	—
	27154A	18.68												
	27263*	18.72												
	28263*	18.72												
	27876*	18.75												
	28876*	18.75												
	C5592*	18.93												

▼ Solid conductors
◆ Siamese version

* Armored
● Duofoil® shield

■ Individually shielded pairs or triads, plus overall foil, overall braid or overall foil and braid.

† Triad
▸ Quad



Multi-conductor and Paired Cable

Less than 25 Conductors

No. of Conductors	Unshielded		Spiral Shield		Braid Shield		Overall Beldfoil®		Overall Foil/Braid		Individual Beldfoil		Individual Braid	
	Part No.	Page	Part No.	Page	Part No.	Page	Part No.	Page	Part No.	Page	Part No.	Page	Part No.	Page
4 AWG														
2	27155A 22180	18.69 18.86	—	—	—	—	—	—	—	—	—	—	—	—
3	27156A 27264* 28264* 27894* 28894* 22181 C5601*	18.69 18.73 18.73 18.75 18.75 18.86 18.93	—	—	—	—	—	—	—	—	—	—	—	—
4	27157A 27265* 28265* 27895* 28895* C5602*	18.69 18.73 18.73 18.75 18.75 18.93	—	—	—	—	—	—	29506	18.30	—	—	—	—
3 AWG														
3	27896* 28896* C5611*	18.75 18.75 18.93	—	—	—	—	—	—	—	—	—	—	—	—
2 AWG														
2	27158A	18.69	—	—	—	—	—	—	—	—	—	—	—	—
3	27159A 27267* 28267* 27888* 28888* C5621*	18.69 18.73 18.73 18.76 18.76 18.93	—	—	—	—	—	—	—	—	—	—	—	—
4	27160A 27268* 28268* 27889* 28889* C5622*	18.69 18.73 18.73 18.76 18.76 18.93	—	—	—	—	—	—	29507	18.30	—	—	—	—
1 AWG														
3	27161A C5625*	18.69 18.94	29528	18.30	—	—	—	—	—	—	—	—	—	—
1/0 AWG														
3	C5627*	18.94	29529	18.30	—	—	—	—	—	—	—	—	—	—
2/0 AWG														
3	—	—	29530	18.30	—	—	—	—	—	—	—	—	—	—
3/0 AWG														
3	6163	18.94	29531	18.30	—	—	—	—	—	—	—	—	—	—
4/0 AWG														
3	—	—	29532	18.30	—	—	—	—	—	—	—	—	—	—

2 • Cable Finder Guide

▼ Solid conductors * Armored ■ Individually shielded pairs or triads, plus overall foil, overall braid or overall foil and braid. † Triad
 ◆ Siamese version ● Duofoil® shield ▸ Quad



Multi-conductor and Paired Cable

Less than 25 Conductors

No. of Conductors	Unshielded		Spiral Shield		Braid Shield		Overall Beldfoil®		Overall Foil/Braid		Individual Beldfoil		Individual Braid	
	Part No.	Page	Part No.	Page	Part No.	Page	Part No.	Page	Part No.	Page	Part No.	Page	Part No.	Page
25 AWG and smaller														
25	—	—	—	—	—	—	8142FO	5.14	9637 8142	4.16 5.27 19.57	—	—	—	—
26	—	—	—	—	—	—	—	—	9813	5.26	—	—	—	—
32	—	—	—	—	—	—	—	—	—	—	7893A [■]	19.28	7886A [▶]	19.17
36	—	—	—	—	—	—	8148FO	5.14	8148 9819	5.27 5.26	—	—	—	—
48	—	—	—	—	—	—	—	—	—	—	—	—	7887A [▶]	19.17
50	—	—	—	—	—	—	8155FO	5.14	9825 8155 1401A	5.26 5.27 15.82	—	—	—	—
62	—	—	—	—	—	—	—	—	9814	5.26	—	—	—	—
64	—	—	—	—	—	—	—	—	—	—	—	—	7888A [▶]	19.17
68	—	—	—	—	—	—	—	—	1403A	15.82	—	—	—	—
96	—	—	—	—	—	—	—	—	—	—	—	—	7889A [▶]	19.17
24 AWG														
25	—	—	—	—	—	—	9543 9684 1424A 82512 88112	4.11 5.15 5.15 5.49 5.50	9617 9937 8342 8112	4.17 4.18 5.29 5.31 19.57	—	—	—	—
30	—	—	—	—	—	—	9544 9515 1425A	4.11 5.12 5.15	8345 8115	5.29 5.31	9735	5.35 19.29	—	—
32	24501848	15.65	—	—	—	—	—	—	—	—	1412R [■] 1514C [■] 1850F [■]	19.18 19.19 19.28	1916A	19.20
34	—	—	—	—	—	—	—	—	—	—	9736	5.35 19.29	—	—
36	—	—	—	—	—	—	—	—	8348 9837 8118	5.29 5.30 5.31	8178 [■] 89758	5.45 5.53 19.30	—	—
37	—	—	—	—	—	—	88118	5.50	9618 9938	4.17 4.18	—	—	—	—
38	—	—	—	—	—	—	9519	5.12	—	—	9737	5.35 19.29	—	—
40	—	—	—	—	—	—	9545	4.11	—	—	1413R [■] 1515C [■]	19.18 19.19	—	—
48	1700S6 1701S6	15.55 15.55	—	—	—	—	—	—	—	—	1414R [■] 1516C [■] 1852F [■]	19.18 19.19 19.28	1924A	19.20
50	9585 [▼] 1864A [▼] 1871A [▼] 1232A1 [▼] 22713010 24501858 24571221 24572XXX 24576XXX 24577XXX 25500XXX	5.4 15.61 15.61 15.63 15.66 15.65 15.65 15.59 15.58 15.58 15.60	—	—	—	—	9546 9525 88125	4.11 5.12 5.50	9619 8355 9838 8125	4.17 5.29 5.30 5.31	9995 8185 [■]	5.37 5.45	—	—
52	—	—	—	—	—	—	—	—	—	—	1415R [■] 1517C [■]	19.18 19.19	—	—
54	—	—	—	—	—	—	—	—	—	—	9738	5.35 19.29	—	—
64	—	—	—	—	—	—	—	—	—	—	1416R [■] 1518C [■] 1854F [■]	19.18 19.19 19.28	1932A	19.20

[▼] Solid conductors
[◆] Siamese version
^{*} Armored
[•] Duofoil[®] shield
[■] Individually shielded pairs or triads, plus overall foil, overall braid or overall foil and braid.
[†] Triad
[▶] Quad



Multi-conductor and Paired Cable

25 or More Conductors

No. of Conductors	Unshielded		Spiral Shield		Braid Shield		Overall Beldfoil®		Overall Foil/Braid		Individual Beldfoil		Individual Braid	
	Part No.	Page	Part No.	Page	Part No.	Page	Part No.	Page	Part No.	Page	Part No.	Page	Part No.	Page
24 AWG (continued)														
100	—	—	—	—	—	—	9550	5.12	—	—	—	—	—	—
104	—	—	—	—	—	—	—	—	—	—	1519C [■]	19.19	—	—
100	24501877	15.65	—	—	—	—	—	—	—	—	—	—	—	—
	24571235	15.65	—	—	—	—	—	—	—	—	—	—	—	—
	22713020	15.66	—	—	—	—	—	—	—	—	—	—	—	—
150	24501887	15.65	—	—	—	—	—	—	—	—	—	—	—	—
200	24501897	15.65	—	—	—	—	—	—	—	—	—	—	—	—
	24571250	15.65	—	—	—	—	—	—	—	—	—	—	—	—
	22713030	15.66	—	—	—	—	—	—	—	—	—	—	—	—
210	22713035	15.66	—	—	—	—	—	—	—	—	—	—	—	—
400	24501906	15.65	—	—	—	—	—	—	—	—	—	—	—	—
	24571265	15.65	—	—	—	—	—	—	—	—	—	—	—	—
	22713040	15.66	—	—	—	—	—	—	—	—	—	—	—	—
500	22713045	15.66	—	—	—	—	—	—	—	—	—	—	—	—
600	24571266	15.65	—	—	—	—	—	—	—	—	—	—	—	—
	22713050	15.66	—	—	—	—	—	—	—	—	—	—	—	—
800	22713060	15.66	—	—	—	—	—	—	—	—	—	—	—	—
1200	22713070	15.66	—	—	—	—	—	—	—	—	—	—	—	—
1800	22713080	15.66	—	—	—	—	—	—	—	—	—	—	—	—
2400	22713090	15.66	—	—	—	—	—	—	—	—	—	—	—	—
22 AWG														
25	8459	4.4	—	—	—	—	—	—	9948 8312	4.19 5.32	—	—	—	—
30	9432	4.4	—	—	—	—	9315 [▼]	5.17	8315	5.32	8766 [▼]	5.37	—	—
	8749	5.5	—	—	—	9524	18.42	8776			5.40 19.23			
32	—	—	—	—	—	—	3010A	18.42	—	—	3011A [■]	18.43	—	—
34	—	—	—	—	—	—	—	—	—	—	1819R [■]	19.21	—	—
											1222B	19.22		
34	—	—	—	—	—	—	—	—	—	—	9769	5.40 19.23	—	—
36	—	—	—	—	—	—	9772 [†]	4.20	8318	5.32	—	—	—	—
37	—	—	—	—	—	—	—	—	9949	4.19	—	—	—	—
38	9748	5.5	—	—	—	—	9319 [▼]	5.17	—	—	8769	5.40	—	—
							9526	18.42			9335	19.23 18.43		
40	9433	4.4	—	—	—	—	—	—	—	—	1820R [■]	19.21	—	—
48	—	—	—	—	—	—	3012A	18.42	—	—	1225B	19.22	—	—
											3013A [■]	18.43		
50	9434	4.4	—	—	—	—	—	—	9950	4.19	—	—	—	—
									8325	5.32				
52	—	—	—	—	—	—	—	—	—	—	1822R [■]	19.21	—	—
54	8750	5.5	—	—	—	—	9327 [▼]	5.17	—	—	8773	5.40	—	—
							9527	18.42			1221B	19.22		
56	—	—	—	—	—	—	—	—	—	—	1221B	19.22	—	—
64	—	—	—	—	—	—	—	—	—	—	1823R [■]	19.21	—	—
											1226B	19.22		
74	—	—	—	—	—	—	—	—	—	—	9767	5.40 19.23	—	—
76	—	—	—	—	—	—	8752 [▼]	5.18	—	—	—	—	—	—
100	—	—	—	—	—	—	3014A	18.42	—	—	3015A [■]	18.43	—	—
102	—	—	—	—	—	—	8751 [▼]	5.17	—	—	—	—	—	—
104	—	—	—	—	—	—	—	—	—	—	1428B	19.22	—	—

[▼] Solid conductors ^{*} Armored [■] Individually shielded pairs or triads, plus overall foil, overall braid or overall foil and braid. [†] Triad
[◆] Siamese version [•] Duofoil[®] shield [▴] Quad



Multi-conductor and Paired Cable

25 or More Conductors

No. of Conductors	Unshielded		Spiral Shield		Braid Shield		Overall Beldfoil®		Overall Foil/Braid		Individual Beldfoil		Individual Braid	
	Part No.	Page	Part No.	Page	Part No.	Page	Part No.	Page	Part No.	Page	Part No.	Page	Part No.	Page
20 AWG														
25	7108A 7408A	18.32 18.34	—	—	—	—	—	—	—	—	—	—	—	—
30	9755	5.7	—	—	—	—	—	—	—	—	9879	5.42	—	—
32	—	—	—	—	—	—	1059A	18.44	—	—	1079A■ 22643■ 23532*■ 26536*■	18.44 18.78 18.80 18.80	—	—
36	—	—	—	—	—	—	3022A†	18.45	—	—	1085A†■ 23571*†■ 26553*†■	18.45 18.80 18.80	—	—
40	—	—	—	—	—	—	—	—	—	—	1091A■	18.44	—	—
48	—	—	—	—	—	—	3023A† 1060A	18.45 18.44	—	—	1092A†■ 22673†■ 23549*†■ 26543*†■ 1080A■ 22647■ 23506*■ 26537*■	18.45 18.78 18.80 18.80 18.44 18.78 18.80 18.80	—	—
60	—	—	—	—	—	—	—	—	—	—	1086A†■	18.45	—	—
72	—	—	—	—	—	—	3024A† 1061A	18.45 18.44	—	—	3067A†■ 22674†■ 23550*†■ 26544*†■ 1081A■ 22670■ 23544*■ 26538*■	18.45 18.78 18.80 18.80 18.44 18.78 18.80 18.80	—	—
100	—	—	—	—	—	—	1062A	18.44	—	—	1082A■ 23575*■ 26546*■	18.44 18.80 18.80	—	—
18 AWG														
25	9626 7117A 7417A 27611A 29053*	4.6 18.32 18.35 18.64 18.88	—	—	7417AS	18.35	—	—	—	—	—	—	—	—
30	27612A 29058* 9742	18.64 18.88 5.8	—	—	—	—	9565	18.46	—	—	9777 9392	5.42 18.46	—	—
32	—	—	—	—	—	—	3034A 1067A	18.47 18.57	—	—	3035A■ 1052A■ 22654■ 23519*■ 26520*■	18.47 18.57 18.78 18.80 18.80	—	—
34	7418A	18.35	—	—	—	—	—	—	—	—	—	—	—	—
36	—	—	—	—	—	—	—	—	—	—	3068A†■ 1095A†■ 23512*†■ 26527*†■	18.48 18.58 18.80 18.80	—	—
37	27613A	18.64	—	—	—	—	—	—	—	—	—	—	—	—
38	9743	5.8	—	—	—	—	—	—	—	—	—	—	—	—

▼ Solid conductors * Armored ■ Individually shielded pairs or triads, plus overall foil, overall braid or overall foil and braid. † Triad
 ◆ Siamese version • Duofoil® shield ▫ Quad



Multi-conductor and Paired Cable

25 or More Conductors

No. of Conductors	Unshielded		Spiral Shield		Braid Shield		Overall Beldfoil®		Overall Foil/Braid		Individual Beldfoil		Individual Braid		
	Part No.	Page	Part No.	Page	Part No.	Page	Part No.	Page	Part No.	Page	Part No.	Page	Part No.	Page	
18 AWG (continued)															
40	29068*	18.88	—	—	—	—	—	—	—	—	—	—	—	—	
41	7419A	18.35	—	—	—	—	—	—	—	—	—	—	—	—	
48	—	—	—	—	—	—	3036A† 1471A 1068A	18.48 18.47 18.57	—	—	3037A†■ 3066A†■ 22681†■ 22683†■ 23537*†■ 26528*†■ 1480A■ 1053A■ 22637■ 23542*■ 26521*■ 22419■ 24520*■ 25517*■	18.48 18.58 18.78 18.78 18.80 18.80 18.47 18.57 18.78 18.80 18.80 18.82 18.83 18.83	—	—	—
50	27614A 29078*	18.64 18.88	—	—	—	—	—	—	—	—	—	—	—	—	
60	27632A	18.64	—	—	—	—	—	—	—	—	—	—	—	—	
72	—	—	—	—	—	—	3038A† 1472A 1087A	18.48 18.47 18.57	—	—	3039A†■ 1096A†■ 22682†■ 22684†■ 23536*†■ 26529*†■ 1481A■ 1054A■ 23554*■ 26555*■	18.48 18.57 18.78 18.78 18.80 18.80 18.47 18.57 18.80 18.80	—	—	—
100	—	—	—	—	—	—	3041A 1088A	18.47 18.57	—	—	3042A■ 1038A■	18.47 18.57	—	—	
16 AWG															
25	9622 7129A 29024* 7429A	4.6 18.33 18.88 18.36	—	—	—	—	—	—	—	—	—	—	—	—	
30	27626A 29008*	18.65 18.88	—	—	—	—	—	—	—	—	—	—	—	—	
32	—	—	—	—	—	—	3050A 1073A	18.49 18.59	—	—	3051A■ 1043A■ 22685■ 23539*■ 26507*■	18.49 18.59 18.79 18.81 18.81	—	—	
34	7430A	18.36	—	—	—	—	—	—	—	—	—	—	—	—	
36	—	—	—	—	—	—	—	—	—	—	3069A†■ 1099A†■ 22690†■ 23541*†■ 26513*†■	18.50 18.60 18.79 18.81 18.81	—	—	
37	27627A	18.65	—	—	—	—	—	—	—	—	—	—	—	—	
40	29009*	18.88	—	—	—	—	—	—	—	—	1044A■	18.59	—	—	

▼ Solid conductors * Armored ■ Individually shielded pairs or triads, plus overall foil, overall braid or overall foil and braid. † Triad
 ◆ Siamese version ● Duofoil® shield ▸ Quad



Multi-conductor and Paired Cable

25 or More Conductors

No. of Conductors	Unshielded		Spiral Shield		Braid Shield		Overall Beldfoil®		Overall Foil/Braid		Individual Beldfoil		Individual Braid	
	Part No.	Page	Part No.	Page	Part No.	Page	Part No.	Page	Part No.	Page	Part No.	Page	Part No.	Page
16 AWG (continued)														
48	—	—	—	—	—	—	3052A†	18.50	—	—	3053A†▪	18.50	—	—
	—	—	—	—	—	—	1489A	18.49	—	—	3118A†▪	18.60	—	—
	—	—	—	—	—	—	1074A	18.59	—	—	23567*†▪	18.81	—	—
	—	—	—	—	—	—	—	—	—	—	26545*†▪	18.81	—	—
	—	—	—	—	—	—	—	—	—	—	1498A▪	18.49	—	—
	—	—	—	—	—	—	—	—	—	—	1045A▪	18.59	—	—
	—	—	—	—	—	—	—	—	—	—	22686▪	18.79	—	—
	—	—	—	—	—	—	—	—	—	—	23538*▪	18.81	—	—
	—	—	—	—	—	—	—	—	—	—	26508*▪	18.81	—	—
	—	—	—	—	—	—	—	—	—	—	22447▪	18.82	—	—
—	—	—	—	—	—	—	—	—	—	24510*▪	18.83	—	—	
—	—	—	—	—	—	—	—	—	—	25519*▪	18.83	—	—	
50	27628A	18.65	—	—	—	—	—	—	—	—	—	—	—	
	29016*	18.88	—	—	—	—	—	—	—	—	—	—	—	
60	27633A	18.65	—	—	—	—	—	—	—	—	—	—	—	
	29025*	18.88	—	—	—	—	—	—	—	—	—	—	—	
72	—	—	—	—	—	—	3054A†	18.50	—	—	3055A†▪	18.50	—	—
	—	—	—	—	—	—	1490A	18.49	—	—	1100A†▪	18.60	—	—
	—	—	—	—	—	—	1089A	18.59	—	—	23578*†▪	18.81	—	—
	—	—	—	—	—	—	—	—	—	—	26547*†▪	18.81	—	—
	—	—	—	—	—	—	—	—	—	—	1499A▪	18.49	—	—
—	—	—	—	—	—	—	—	—	—	1046A▪	18.59	—	—	
—	—	—	—	—	—	—	—	—	—	23568*▪	18.81	—	—	
—	—	—	—	—	—	—	—	—	—	26551*▪	18.81	—	—	
100	—	—	—	—	—	—	3056A	18.49	—	—	3057A▪	18.49	—	—
	—	—	—	—	—	—	1090A	18.59	—	—	1047A▪	18.59	—	—
108	—	—	—	—	—	—	—	—	—	—	3130A†▪	18.60	—	—
14 AWG														
25	7442A	18.37	—	—	—	—	—	—	—	—	—	—	—	—
	27103A	18.66	—	—	—	—	—	—	—	—	—	—	—	—
	27270*	18.71	—	—	—	—	—	—	—	—	—	—	—	—
	28270*	18.71	—	—	—	—	—	—	—	—	—	—	—	—
	27851*	18.74	—	—	—	—	—	—	—	—	—	—	—	—
	28851*	18.74	—	—	—	—	—	—	—	—	—	—	—	—
	C5503*	18.89	—	—	—	—	—	—	—	—	—	—	—	—
C5523	18.89	—	—	—	—	—	—	—	—	—	—	—	—	
26	27104A	18.66	—	—	—	—	—	—	—	—	—	—	—	
27	27105A	18.66	—	—	—	—	—	—	—	—	—	—	—	
28	27106A	18.66	—	—	—	—	—	—	—	—	—	—	—	
29	27107A	18.66	—	—	—	—	—	—	—	—	—	—	—	
30	27108A	18.66	—	—	—	—	—	—	—	—	—	—	—	—
	27253*	18.71	—	—	—	—	—	—	—	—	—	—	—	—
	28253*	18.71	—	—	—	—	—	—	—	—	—	—	—	—
	27852*	18.74	—	—	—	—	—	—	—	—	—	—	—	—
	28852*	18.74	—	—	—	—	—	—	—	—	—	—	—	—
C5528*	18.89	—	—	—	—	—	—	—	—	—	—	—	—	
37	27629A	18.66	—	—	—	—	—	—	—	—	—	—	—	—
	27292*	18.71	—	—	—	—	—	—	—	—	—	—	—	—
	28292*	18.71	—	—	—	—	—	—	—	—	—	—	—	—

▼ Solid conductors * Armored ▪ Individually shielded pairs or triads, plus overall foil, overall braid or overall foil and braid. † Triad
 ♦ Siamese version • Duofoil® shield ▫ Quad



Multi-conductor Cable

Less than 25 Conductors

No. of Conductors	Unshielded		Spiral Shield		Braid Shield		Overall Beldfoil®		Overall Foil/Braid		Individual Beldfoil		Individual Braid	
	Part No.	Page	Part No.	Page	Part No.	Page	Part No.	Page	Part No.	Page	Part No.	Page	Part No.	Page
14 AWG (continued)														
40	27433*	18.71	—	—	—	—	—	—	—	—	—	—	—	—
	28433*	18.71												
	27885*	18.74												
	28885*	18.74												
	C5529*	18.89												
50	27912A	18.66	—	—	—	—	—	—	—	—	—	—	—	—
	27434*	18.71												
	28434*	18.71												
	27886*	18.74												
	28886*	18.74												
	C6064*	18.89												
12 AWG														
25	27132A	18.67	—	—	—	—	—	—	—	—	—	—	—	—
	27279*	18.71												
	28279*	18.71												
	27864*	18.74												
	28864*	18.74												
	C5553*	18.89												
26	27133A	18.67	—	—	—	—	—	—	—	—	—	—	—	—
27	27134A	18.67	—	—	—	—	—	—	—	—	—	—	—	—
28	27135A	18.67	—	—	—	—	—	—	—	—	—	—	—	—
29	27136A	18.67	—	—	—	—	—	—	—	—	—	—	—	—
30	27137A	18.67	—	—	—	—	—	—	—	—	—	—	—	—
	27280*	18.71												
	28280*	18.71												
	27865*	18.74												
	28865*	18.74												
	C5558*	18.89												
37	27630A	18.67	—	—	—	—	—	—	—	—	—	—	—	—
	27540*	18.71												
	28540*	18.71												
40	27432*	18.71	—	—	—	—	—	—	—	—	—	—	—	—
	28432*	18.71												
	27887*	18.74												
	28887*	18.74												
50	27634A	18.67	—	—	—	—	—	—	—	—	—	—	—	—
10 AWG														
25	27289*	18.72	—	—	—	—	—	—	—	—	—	—	—	—
	28289*	18.72												
	27883*	18.75												
	28883*	18.75												
	C5579*	18.90												
30	27290*	18.72	—	—	—	—	—	—	—	—	—	—	—	—
	28290*	18.72												
	27884*	18.75												
	28884*	18.75												
	C5580*	18.90												

2 • Cable Finder Guide

▼ Solid conductors * Armored ■ Individually shielded pairs or triads, plus overall foil, overall braid or overall foil and braid. † Triad
 ♦ Siamese version ● Duofoil® shield ▸ Quad



Multi-conductor and Paired Cables

Combination Gages (Unshielded, Shielded and Partially Shielded)

No. of Conductors or Pairs	Part No.	Conductor/Gage Description	Shielding	Page
Combination Gages				
4	3084A	1pr — 24 AWG 1pr — 22 AWG	Beldfoil® each pair plus braid overall	18.23
	3084F	1pr — 24 AWG 1pr — 22 AWG	Beldfoil each pair plus braid overall	18.23
	3085A	1pr — 24 AWG 1pr — 22 AWG	Beldfoil each pair plus braid overall	18.23
	7895A	1pr — 20 AWG 1pr — 18 AWG	Beldfoil each pair plus braid overall	18.24
	7900A	1pr — 18 AWG 1pr — 16 AWG	Unshielded	18.22
	7896A	1pr — 18 AWG 1pr — 16 AWG	Beldfoil each pair plus braid overall	18.22
	7897A	1pr — 18 AWG 1pr — 15 AWG	Beldfoil each pair plus braid overall	18.22
	3082A	1pr — 18 AWG 1pr — 15 AWG	Beldfoil each pair plus braid overall	18.23
	3083A	1pr — 18 AWG 1pr — 15 AWG	Beldfoil each pair plus braid overall	18.23
	3082F	1pr — 18 AWG 1pr — 15 AWG	Beldfoil each pair plus braid overall	18.23
	3086A	1pr — 20 AWG 1pr — 16 AWG	Individual Beldfoil each pair	18.25
	3124A	2c — 22 AWG 2c — 18 AWG	Overall Beldfoil	18.26
	3125A	2c — 22 AWG 2c — 16 AWG	Overall Beldfoil	18.26
	1502P	1pr — 22 AWG	Beldfoil	19.39
		2c — 18 AWG	Unshielded	
	1502R	1pr — 22 AWG	Beldfoil	19.39
		2c — 18 AWG	Unshielded	
	9155	1pr — 20 AWG	Beldfoil	5.47
		1pr — 18 AWG	Unshielded	
	6	8446	4c — 22 AWG 2c — 18 AWG	Unshielded
9686		3c — 20 AWG 3c — 16 AWG	Unshielded	4.7
8786		4c — 24 AWG 2c — 22 AWG	Beldfoil over 4c, Unshielded	4.20
3126A		2c — 22 AWG 2c — 16 AWG 2c — 12 AWG	Overall Beldfoil	18.26
27428*		3c — 14 AWG 3c — 12 AWG	Unshielded	18.73
28428*		3c — 14 AWG 3c — 12 AWG	Unshielded	18.73
27429*		3c — 14 AWG 3c — 10 AWG	Unshielded	18.73
28429*		3c — 14 AWG 3c — 10 AWG	Unshielded	18.73
27430*		3c — 14 AWG 3c — 8 AWG	Unshielded	18.73
28430*		3c — 14 AWG 3c — 8 AWG	Unshielded	18.73
27431*		3c — 14 AWG 3c — 6 AWG	Unshielded	18.73

No. of Conductors or Pairs	Part No.	Conductor/Gage Description	Shielding	Page	
Combination Gages					
6 <i>(cont'd)</i>	28431*	3c — 14 AWG 3c — 6 AWG	Unshielded	18.73	
	27890*	3c — 14 AWG 3c — 12 AWG	Unshielded	18.76	
	28890*	3c — 14 AWG 3c — 12 AWG	Unshielded	18.76	
	27891*	3c — 14 AWG 3c — 10 AWG	Unshielded	18.76	
		28891*			3c — 14 AWG 3c — 10 AWG
	27892*	3c — 14 AWG 3c — 8 AWG	Unshielded	18.76	
		28892*			3c — 14 AWG 3c — 8 AWG
		27893*			3c — 14 AWG 3c — 6 AWG
		28893*			3c — 14 AWG 3c — 6 AWG
		6054*			3c — 14 AWG 3c — 12 AWG
		6051*			3c — 14 AWG 3c — 10 AWG
		6059*			3c — 14 AWG 3c — 8 AWG
		6060*			3c — 14 AWG 3c — 6 AWG
	8	9405	6c — 18 AWG 2c — 16 AWG	Unshielded	4.8
		8448	6c — 22 AWG 2c — 18 AWG	Unshielded	4.8
9903*		3pr — 28 AWG 1pr — 24 AWG	Individual Beldfoil plus braid	15.75	
9891*		3pr — 22 AWG 1pr — 20 AWG	Individual Beldfoil plus braid	15.76	
9		3119A*	3pr — 24 AWG 3c — 18 AWG	Overall Beldfoil plus braid	18.27
10	8787	4c — 24 AWG 4c — 24 AWG 2c — 22 AWG	Red or Green Beldfoil over (2) Quads, Unshielded	4.20	
12	7949A	4pr — 24 AWG ▼ 4c — 16 AWG	Unshielded	21.8	
	7950A	4pr — 24 AWG ▼ 4c — 16 AWG	Unshielded	21.8	
	7951A	4pr — 24 AWG ▼ 4c — 18 AWG	Unshielded	21.8	
	7952A	4pr — 24 AWG ▼ 4c — 14 AWG	Unshielded	21.8	
23	9641	6pr — 26 AWG 10c — 26 AWG 1c — 24 AWG	Overall foil plus braid	4.16	

▼ Solid conductors
◆ Siamese version

* Armored
● Duofoil® shield

■ Individually shielded pairs or triads, plus overall foil, overall braid or overall foil and braid.

† Triad
♦ Quad



Multi-conductor and Paired Cables

Partially Shielded Cables (Combination Unshielded and Shielded Conductors)

No. of Conductors	Part No.	Conductor/Gage Description	Shielding	Page
25 AWG				
4	8434	1pr — 25 AWG	Beldfoil®	5.46
		1pr — 25 AWG	Unshielded plus overall foil shield	
22 AWG				
3	8734	1c — 22 AWG	Braid	4.14
		2c — 22 AWG	Unshielded	
	9685	1pr — 22 AWG	Beldfoil	5.46
		1c — 22 AWG	Unshielded	
4	8732	1pr — 22 AWG	Braid	5.23
		1pr — 22 AWG	Unshielded	
	8730	1pr — 22 AWG	Beldfoil	5.46
		1pr — 22 AWG	Unshielded	
	8724	1pr — 22 AWG	Beldfoil	5.46
		1pr — 22 AWG	Unshielded	
5	8788	3c — 22 AWG	Individual Beldfoil	4.20
		2c — 22 AWG	Unshielded	
12	9689	2pr — 22 AWG	Individual Beldfoil plus overall braid	15.80
		4pr — 22 AWG	Unshielded	
	82689	2pr — 22 AWG	Individual Beldfoil plus overall braid	15.80
		4pr — 22 AWG	Unshielded	
20 AWG				
3	8763	1pr — 20 AWG	Beldfoil	5.47
		1c — 20 AWG	Unshielded	
4	8722	1pr — 20 AWG	Beldfoil	5.47
		1pr — 20 AWG	Unshielded	

▼ Solid conductors
◆ Siamese version

* Armored
● Duofoil® shield

■ Individually shielded pairs or triads, plus overall foil, overall braid or overall foil and braid.

† Triad
▸ Quad

Paired Cable

No. of Pairs	Unshielded		Spiral Shield		Braid Shield		Overall Beldfoil®		Overall Foil/Braid		Individual Beldfoil		Individual Braid	
	Part No.	Page	Part No.	Page	Part No.	Page	Part No.	Page	Part No.	Page	Part No.	Page	Part No.	Page
25 AWG and smaller														
1	—	—	—	—	—	—	9271 9180	6.88 18.17 19.27 19.58	—	—	—	—	—	—
2	—	—	—	—	—	—	8132FO	5.14	9804 8132	5.26 5.27	1215A [■] 7891A [■]	15.80 19.28	—	—
3	—	—	—	—	—	—	8133FO	5.14	9805 8133 1538A	5.26 5.27 15.81	—	—	—	—
4	—	—	—	—	—	—	8134FO	5.14	9806 8134	5.26 5.27	7890A [■]	19.28	—	—
5	—	—	—	—	—	—	8135FO	5.14	9807 8135	5.26 5.27	—	—	—	—
7	—	—	—	—	—	—	—	—	9808	5.26	—	—	—	—
8	—	—	—	—	—	—	8138FO	5.14	8138	5.27	7880A [■]	19.28	—	—
9	—	—	—	—	—	—	—	—	9809	5.26	—	—	—	—
12	—	—	—	—	—	—	—	—	9812	5.26	7892A [■]	19.28	—	—
12-1/2	—	—	—	—	—	—	8142FO	5.14	8142	5.27 19.57	—	—	—	—
13	—	—	—	—	—	—	—	—	9813	5.26	—	—	—	—
16	—	—	—	—	—	—	—	—	—	—	7893A [■]	19.28	—	—
18	—	—	—	—	—	—	8148FO	5.14	8148 9819	5.27 5.26	—	—	—	—
25	—	—	—	—	—	—	8155FO	5.14	9825 8155 1401A	5.26 5.27 15.82	—	—	—	—
31	—	—	—	—	—	—	—	—	9814	5.26	—	—	—	—
34	—	—	—	—	—	—	—	—	1403A	15.82	—	—	—	—
24 AWG														
1	—	—	—	—	1800F	19.5	9501 8641 82641 88641 1508A 1883A 1800B 1801B	5.11 5.16 19.10 5.13 5.16 5.49 19.10 5.13 5.16 5.49 19.19 5.16 19.9 5.16 19.9 19.27 21.24 19.27	9841 82841 89841 7200A 7205A 7206A	5.28 5.28 5.52 5.28 18.39 18.39 18.39	—	—	—	—
2	9562 [▼] 1588A [▼] 1588R [▼] 1590A [▼] 1227A1 [▼] 1243A2 [▼] 24501922 7932A	5.4 15.56 15.56 15.57 15.63 15.63 15.64 18.8	—	—	—	—	9502 82502 1419A 88102 7933A 89842	5.11 5.13 5.49 5.15 5.50 18.9 5.28 5.52	9842 82842 8332 9829 8102 7201A	5.28 5.28 5.52 5.29 5.30 5.31 18.39	9729 89729 82729	5.35 18.29 19.29 5.36 5.53 19.30 5.36 5.53 19.30	1902A	19.20
											1802B [*] 1509C [■] 8162 [■]	19.27 19.19 5.44		

[▼] Solid conductors * Armored ■ Individually shielded pairs or triads, plus overall foil, overall braid or overall foil and braid. † Triad
[◆] Siamese version ● Duofoil[®] shield ◼ Quad



Paired Cable

No. of Pairs	Unshielded		Spiral Shield		Braid Shield		Overall Beldfoil®		Overall Foil/Braid		Individual Beldfoil		Individual Braid	
	Part No.	Page	Part No.	Page	Part No.	Page	Part No.	Page	Part No.	Page	Part No.	Page	Part No.	Page
24 AWG (continued)														
3	24501934	15.64	—	—	—	—	9503	5.11	9843	5.28	9730	5.35	—	—
	24571097	15.64					82503	5.13	8333	5.29		19.29		
								5.49	9830	5.30	89730	5.36		
							89503	5.13	8103	5.31		5.53		
								5.49	3120A	18.27		19.30		
							9680	5.15	7202A	18.39	8163 [■]	5.44		
							1420A	5.15			9990	5.37		
							88103	5.50						
4	1229A1 [▼]	15.63	—	—	—	—	9504	5.11	9844	5.28	9728	5.35	1904A	19.20
	1245A2 [▼]	15.63					82504	5.13	8334	5.29		19.29		
	1304A	19.76						5.49	9831	5.30	89728	5.36		
	1305A	19.76					89504	5.13	8104	5.31		5.53		
	1500A [▼]	15.54					9681	5.15	7203A	18.39		19.30		
	1500R [▼]	15.54					1421A	5.15	7921A	18.9	8164 [■]	5.44		
		21.10					88104	5.50	89842	5.28	1408R [■]	19.18		
	1501A [▼]	15.54					1533R [▼]	15.67		5.52	1510C [■]	19.19		
	1583A [▼]	15.56					1533P [▼]	15.67			1803F [■]	19.28		
	1583B [▼]	15.56					1624R [▼]	15.68						
	1583R [▼]	15.56					1624P [▼]	15.68						
		21.11					1633A [▼]	15.69						
	1585A [▼]	15.57					7929A	18.9						
		21.11					7919A	18.10						
	1585B [▼]	15.57					1300A	19.76						
	1585LC [▼]	15.57					1300SB	15.67						
	1592A	15.57						19.76						
	1594A [▼]	15.56												
	1700A [▼]	15.50												
	1700R [▼]	15.50												
	1701A [▼]	15.50												
		21.10												
	1701LC [▼]	15.50												
	1752A	15.73												
	1875GB	15.72												
	7918A	18.10												
	7923A	18.8												
	7924A	18.9												
	7928A	18.8												
	7930A	18.10												
	7934A	18.8												
	7987P	19.74												
	7987R	19.74												
	7988P	15.71												
		19.75												
	7988R	15.71												
		19.75												
	7997A	15.56												
	11700A	18.8												
	11700A2	18.8												
121700A*	18.10													
24501XXX	15.65													
24566XXX	15.65													
24567XXX	15.65													
24568XXX	15.65													
24570XXX	15.65													
24571XXX	15.65													
5	—	—	—	—	—	—	9505	5.11	8335	5.29	8165 [■]	5.44	—	—
							82505	5.13	9832	5.30	89705	5.53		
								5.49	8105	5.31		19.30		
							89505	5.13						
								5.49						
							1422A	5.15						
						88105	5.50							

[▼] Solid conductors
[◆] Siamese version
^{*} Armored
[●] Duofoil[®] shield
[■] Individually shielded pairs or triads, plus overall foil, overall braid or overall foil and braid.
[†] Triad
[■] Quad



Paired Cable

No. of Pairs	Unshielded		Spiral Shield		Braid Shield		Overall Beldfoil®		Overall Foil/Braid		Individual Beldfoil		Individual Braid	
	Part No.	Page	Part No.	Page	Part No.	Page	Part No.	Page	Part No.	Page	Part No.	Page	Part No.	Page
24 AWG (continued)														
6	9566▼ 24501829	5.4 15.65	—	—	—	—	9506 82506 9682 1423A 88106	5.12 5.13 5.15 5.15 5.50	8336 9839 8106	5.29 5.30 5.31	9731 89731 9991 8166■ 1409R■ 1511C■	5.35 19.29 5.36 5.53 19.30 5.37 5.44 19.18 19.19	1906A	19.20
7	—	—	—	—	—	—	9507	5.12	8337 9833 8107	5.29 5.30 5.31	8167■ 89757	5.44 5.53 19.30	—	—
7-1/2	—	—	—	—	—	—	88107	5.50	—	—	—	—	—	—
8	1702A◆▼ 1703A◆▼	15.50 15.50	—	—	—	—	9508 1668A▼	5.12 15.69	8108	5.31	8168■ 1410R■ 1512C■ 1805F■	5.45 19.18 19.19 19.28	1908A	19.20
9	—	—	—	—	—	—	9509 82509 9683 88109	5.12 5.13 5.49 5.15 5.50	9834	5.30	9732 89732 9992	5.35 19.29 5.36 5.53 19.30 5.37	—	—
10	9570▼	5.4	—	—	—	—	9510	5.12	8340 9835 8110	5.29 5.30 5.31	8170■	5.45	—	—
11	—	—	—	—	—	—	—	—	—	—	9733	5.35 19.29	—	—
12	24501837	15.65	—	—	—	—	—	—	9836	5.30	9734 9993 89734 1411R■ 1513C■ 1806F■	5.35 19.29 5.37 5.53 19.30 19.18 19.19 19.28	1912A	19.20
12-1/2	—	—	—	—	—	—	9684 1424A 82512 88112	5.15 5.15 5.49 5.50	8342 8112	5.29 5.31 19.57	—	—	—	—
15	—	—	—	—	—	—	9515 1425A	5.12 5.15	8345 8115	5.29 5.31	9735 8175■	5.35 19.29 5.45	—	—
16	24501848	15.65	—	—	—	—	—	—	—	—	1412R■ 1514C■ 1850F■	19.18 19.19 19.28	1916A	19.20
17	—	—	—	—	—	—	—	—	—	—	9736	5.35 19.29	—	—
18	—	—	—	—	—	—	—	—	8348 9837 8118	5.29 5.30 5.31	8178■ 89758	5.45 5.53 19.30	—	—
18-1/2	—	—	—	—	—	—	88118	5.50	—	—	—	—	—	—
19	—	—	—	—	—	—	9519	5.12	—	—	9737	5.35 19.29	—	—
20	—	—	—	—	—	—	—	—	—	—	1413R■ 1515C■	19.18 19.19	—	—
24	1700S6 1701S6	15.55 15.55	—	—	—	—	—	—	—	—	1414R■ 1516C■ 1852F■	19.18 19.19 19.28	1924A	19.20

▼ Solid conductors * Armored ■ Individually shielded pairs or triads, plus overall foil, overall braid or overall foil and braid. † Triad
◆ Siamese version • Duofoil® shield ▫ Quad



Paired Cable

No. of Pairs	Unshielded		Spiral Shield		Braid Shield		Overall Beldfoil®		Overall Foil/Braid		Individual Beldfoil		Individual Braid	
	Part No.	Page	Part No.	Page	Part No.	Page	Part No.	Page	Part No.	Page	Part No.	Page	Part No.	Page
24 AWG (continued)														
25	9585▼	5.4	—	—	—	—	9525	5.12	8355	5.29	9995	5.37	—	—
	1864A▼	15.61	—	—	—	—	88125	5.50	9838	5.30	8185■	5.45	—	—
	1871A▼	15.61	—	—	—	—	—	—	8125	5.31	—	—	—	—
	1232A1▼	15.63	—	—	—	—	—	—	—	—	—	—	—	—
	22713010	15.66	—	—	—	—	—	—	—	—	—	—	—	—
	24501858	15.65	—	—	—	—	—	—	—	—	—	—	—	—
	24570XXX	15.65	—	—	—	—	—	—	—	—	—	—	—	—
	24571221	15.65	—	—	—	—	—	—	—	—	—	—	—	—
	25500XXX	15.60	—	—	—	—	—	—	—	—	—	—	—	—
	26	—	—	—	—	—	—	—	—	—	—	1415R■	19.18	—
											1517C■	19.19	—	—
27	—	—	—	—	—	—	—	—	—	—	9738	5.35	—	—
											19.29	—	—	
32	—	—	—	—	—	—	—	—	—	—	1416R■	19.18	1932A	19.20
											1518C■	19.19	—	—
											1854F■	19.28	—	—
50	24501877	15.65	—	—	—	—	9550	5.12	—	—	1519C■	19.19	—	—
	24571235	15.65	—	—	—	—	—	—	—	—	—	—	—	—
	22713020	15.66	—	—	—	—	—	—	—	—	—	—	—	—
75	24501887	15.65	—	—	—	—	—	—	—	—	—	—	—	—
100	24501897	15.65	—	—	—	—	—	—	—	—	—	—	—	—
	24571250	15.65	—	—	—	—	—	—	—	—	—	—	—	—
	22713030	15.66	—	—	—	—	—	—	—	—	—	—	—	—
105	22713035	15.66	—	—	—	—	—	—	—	—	—	—	—	—
200	24501906	15.65	—	—	—	—	—	—	—	—	—	—	—	—
	24571265	15.65	—	—	—	—	—	—	—	—	—	—	—	—
	22713040	15.66	—	—	—	—	—	—	—	—	—	—	—	—
250	22713045	15.66	—	—	—	—	—	—	—	—	—	—	—	—
300	24571266	15.65	—	—	—	—	—	—	—	—	—	—	—	—
	22713050	15.66	—	—	—	—	—	—	—	—	—	—	—	—
400	22713060	15.66	—	—	—	—	—	—	—	—	—	—	—	—
600	22713070	15.66	—	—	—	—	—	—	—	—	—	—	—	—
900	22713080	15.66	—	—	—	—	—	—	—	—	—	—	—	—
1200	22713090	15.66	—	—	—	—	—	—	—	—	—	—	—	—
23 AWG														
4	1872A▼	15.48	—	—	—	—	—	—	—	—	—	—	—	—
	1874A▼	15.48	—	—	—	—	—	—	—	—	—	—	—	—
	7813LC	15.53	—	—	—	—	—	—	—	—	—	—	—	—
	7851A▼	15.46	—	—	—	—	—	—	—	—	—	—	—	—
	7851NH	15.46	—	—	—	—	—	—	—	—	—	—	—	—
	7852A▼	15.46	—	—	—	—	—	—	—	—	—	—	—	—
	7881A▼	15.52	—	—	—	—	—	—	—	—	—	—	—	—
		21.9	—	—	—	—	—	—	—	—	—	—	—	—
	7882A▼	15.52	—	—	—	—	—	—	—	—	—	—	—	—
		21.9	—	—	—	—	—	—	—	—	—	—	—	—
	7883A▼	15.72	—	—	—	—	—	—	—	—	—	—	—	—
	7927A	18.11	—	—	—	—	—	—	—	—	—	—	—	—
	7931A	18.11	—	—	—	—	—	—	—	—	—	—	—	—
	7989P	15.70	—	—	—	—	—	—	—	—	—	—	—	—
		19.75	—	—	—	—	—	—	—	—	—	—	—	—
	7989R	15.70	—	—	—	—	—	—	—	—	—	—	—	—
		19.75	—	—	—	—	—	—	—	—	—	—	—	—
		11872A▼	18.11	—	—	—	—	—	—	—	—	—	—	—
		121872A*▼	18.11	—	—	—	—	—	—	—	—	—	—	—
		24586XXX	15.47	—	—	—	—	—	—	—	—	—	—	—
	24587XXX	15.47	—	—	—	—	—	—	—	—	—	—	—	
	24588XXX	15.47	—	—	—	—	—	—	—	—	—	—	—	

▼ Solid conductors * Armored ■ Individually shielded pairs or triads, plus overall foil, overall braid or overall foil and braid. † Triad
 ◆ Siamese version ● Duofoil® shield ▴ Quad



Paired Cable

No. of Pairs	Unshielded		Spiral Shield		Braid Shield		Overall Beldfoil®		Overall Foil/Braid		Individual Beldfoil		Individual Braid			
	Part No.	Page	Part No.	Page	Part No.	Page	Part No.	Page	Part No.	Page	Part No.	Page	Part No.	Page		
22 AWG																
1	8740▼	5.4	8737	5.24	8437▼	5.23	8450▼	19.10	3079A	18.21	—	—	—	—		
	88442	4.4					9414	5.18							3105A	18.28
		4.23													1696A	19.27
		5.6														
		5.48														
	82442	4.4													9461	5.18
		4.23														19.11
		5.6													8451	5.19
		5.48														19.10
	9407	18.42													9451	5.19
	9151	12.33														19.10
	8451	5.19													1266A	5.19
		19.10														19.10
															1503A	5.19
																19.10
															88761	5.20
																5.51
																19.11
															87761	5.20
																5.51
																19.11
															82761	5.20
																5.51
																19.11
															9182•	6.88
																18.17
															89182•	6.88
																18.17
				3077F	18.21											
				3078F	18.21											
				3079E	18.21											
				9322	18.42											
				9451P	5.20											
					19.10											
				9451SB	5.19											
					19.10											
1-1/2	—	—	—	—	—	—	—	—	3106A	18.28	—	—	—	—		
2	8741▼	5.4	—	—	—	—	9302▼	5.17	8302	5.32	9406	5.38	—	—		
	9744	5.5					9184▼	5.17	9855▼	5.33	8723	5.38				
	88741	5.6					3000A	18.42	1268A▼	5.33		18.29				
		5.48					9512	18.42	89855▼	5.33		19.12				
		5.6					9451DP	5.19		5.52		21.24				
	82741	5.6						19.13	1269A▼	5.33	82723	5.38				
									9696▼	5.33		5.54				
									89696▼	5.33		19.12				
										5.52	88723	5.38				
												5.54				
											3107A	18.28				
												18.29				
												19.12				
												5.38				
												5.54				
												19.12				
												5.46				
												15.79				
												15.79				
												15.79				
												18.25				
												19.13				
							5.20									
							19.13									
							18.43									
							18.43									
							19.21									
							5.38									
							19.12									

▼ Solid conductors * Armored ■ Individually shielded pairs or triads, plus overall foil, overall braid or overall foil and braid. † Triad
 ♦ Siamese version • Duofoil® shield ▫ Quad



Paired Cable

No. of Pairs	Unshielded		Spiral Shield		Braid Shield		Overall Beldfoil®		Overall Foil/Braid		Individual Beldfoil		Individual Braid	
	Part No.	Page	Part No.	Page	Part No.	Page	Part No.	Page	Part No.	Page	Part No.	Page	Part No.	Page
22 AWG (continued)														
3	8742▼	5.4	—	—	—	—	9513	18.42	8303 3108A	5.32 18.28	8767▼	5.37	—	—
	9745	5.5									8777	5.40		
	82742	5.6										18.27		
		5.48									82777	5.41		
											5.54			
											19.24			
											88777	5.41		
											5.54			
											19.24			
											87777	5.41		
											5.54			
											19.24			
											8777SB	5.40		
											19.12			
											9329	18.43		
4	8757▼	5.4	—	—	—	—	9305▼ 3004A 9514 8723SB	5.17 18.42 18.42 5.38 19.12	8304 3109A 9891	5.32 18.28 15.76	9330	18.43	—	—
	9746	5.5									3005A■	18.43		
	88757	5.6									1815R■	19.21		
		5.48									1217B	19.22		
	82757	5.6												
		5.48												
	7922A	18.9												
5	—	—	—	—	—	—	—	8305	5.32	—	—	—	—	
6	8743▼	5.4	—	—	—	—	9306▼ 9516	5.17 18.42	8306	5.32	8768▼	5.37	—	—
	8747	5.5									8778	5.40		
	82743	5.6										19.23		
		5.48									82778	5.41		
										5.54				
										19.24				
										88778	5.41			
										5.54				
										19.24				
										87778	5.41			
										5.54				
										19.24				
										9331	18.43			
										1816R■	19.21			
										1218B	19.22			
7	—	—	—	—	—	—	—	8307	5.32	—	—	—	—	
8	9160▼	5.4	—	—	—	—	3006A	18.42	8308	5.32	3007A■	18.43	—	—
											1817R■	19.21		
9	8744▼	5.4	—	—	—	—	9309▼ 9520	5.17 18.42	—	—	8764▼	5.37	—	—
	8748	5.5									8774	5.40		
											19.23			
											9332	18.43		
											1219B	19.22		
10	—	—	—	—	—	—	—	—	8310	5.32	—	—	—	—
11	—	—	—	—	—	—	9521	18.42	—	—	8765▼	5.37	—	—
											8775	5.40		
												19.23		
											9333	18.43		
12	9747	5.5	—	—	—	—	3008A	18.42	—	—	9768	5.40	—	—
											19.23			
											3009A■	18.43		
											1818R■	19.21		
											1220B	19.22		
12-1/2	—	—	—	—	—	—	—	—	8312	5.32	—	—	—	—
15	8749	5.5	—	—	—	—	9315▼ 9524	5.17 18.42	8315	5.32	8766▼	5.37	—	—
											8776	5.40		
											19.23			

▼ Solid conductors * Armored ■ Individually shielded pairs or triads, plus overall foil, overall braid or overall foil and braid. † Triad
 ◆ Siamese version • Duofoil® shield ▴ Quad



Paired Cable

No. of Pairs	Unshielded		Spiral Shield		Braid Shield		Overall Beldfoil®		Overall Foil/Braid		Individual Beldfoil		Individual Braid			
	Part No.	Page	Part No.	Page	Part No.	Page	Part No.	Page	Part No.	Page	Part No.	Page	Part No.	Page		
22 AWG (continued)																
16	—	—	—	—	—	—	3010A	18.42	—	—	3011A [■] 1819R [■] 1222B	18.43 19.21 19.22	—	—		
17	—	—	—	—	—	—	—	—	—	—	9769	5.40 19.23	—	—		
18	—	—	—	—	—	—	—	—	8318	5.32	—	—	—	—		
19	9748	5.5	—	—	—	—	9319 [▼] 9526	5.17 18.42	—	—	8769 9335	5.40 19.23 18.43	—	—		
20	—	—	—	—	—	—	—	—	—	—	1820R [■] 1225B	19.21 19.22	—	—		
24	—	—	—	—	—	—	3012A	18.42	—	—	3013A [■] 1821R [■] 1427B	18.43 19.21 19.22	—	—		
25	—	—	—	—	—	—	—	—	8325	5.32	—	—	—	—		
26	—	—	—	—	—	—	—	—	—	—	1822R [■]	19.21	—	—		
27	8750	5.5	—	—	—	—	9327 [▼] 9527	5.17 18.42	—	—	8773	5.40 19.23	—	—		
28	—	—	—	—	—	—	—	—	—	—	1221B	19.22	—	—		
32	—	—	—	—	—	—	—	—	—	—	1823R [■] 1226B	19.21 19.22	—	—		
37	—	—	—	—	—	—	—	—	—	—	9767	5.40 19.23	—	—		
38	—	—	—	—	—	—	8752 [▼]	5.18	—	—	—	—	—	—		
50	—	—	—	—	—	—	3014A	18.42	—	—	3015A [■]	18.43	—	—		
51	—	—	—	—	—	—	8751 [▼]	5.17	—	—	—	—	—	—		
52	—	—	—	—	—	—	—	—	—	—	1428B	19.22	—	—		
20 AWG																
1	8205 9408 83930 83932 83934 83900 83905 83910 83915	19.35 18.43 18.55 18.55 18.55 18.55 18.55 18.55 18.55	8759	19.13	—	—	8762 9464 9154 9320 1033A 3111A 3112A 3113A 83955 83950 83952 83954	5.20 19.13 5.20 19.13 18.44 18.44 18.54 18.54 18.54 18.55 18.55 18.55 18.55	9463 9463DB 89463 129463* 139463* 189463* 9463F	6.87 18.14 18.14 5.21 18.14 18.14 18.14	—	—	22671 [■] 23543 ^{*■} 26530 ^{*■}	18.78 18.80 18.80	—	—
2	—	—	—	—	—	—	3016A	15.44	—	—	9402 1075A [■] 3115A [■] 22638 [■] 23534 ^{*■} 26531 ^{*■}	5.41 18.44 18.54 18.78 18.80 18.80	—	—		
3	9750	5.7	—	—	—	—	—	—	—	—	9883 9873	5.41 5.42	—	—		
4	—	—	—	—	—	—	85164 1056A	5.11 18.44	9891 9892 89892	15.76 15.76 15.76	8725 9901 ^{●■} 89901 ^{●■} 1076A [■] 1006A [■] 1012A [■] 22639 [■] 23514 ^{*■} 26532 ^{*■}	5.47 15.75 15.75 18.44 18.54 18.54 18.78 18.80 18.80	—	—		

[▼] Solid conductors
 * Armored
 ■ Individually shielded pairs or triads, plus overall foil, overall braid or overall foil and braid.
 † Triad
[●] Siamese version
 ● Duofoil[®] shield
 † Quad



Paired Cable

No. of Pairs	Unshielded		Spiral Shield		Braid Shield		Overall Beldfoil®		Overall Foil/Braid		Individual Beldfoil		Individual Braid	
	Part No.	Page	Part No.	Page	Part No.	Page	Part No.	Page	Part No.	Page	Part No.	Page	Part No.	Page
20 AWG (continued)														
5	—	—	—	—	—	—	—	—	—	—	9902*■	15.75	—	—
6	9751	5.7	—	—	—	—	—	—	—	—	9886 9874 22640■ 23513*■ 26533*■	5.41 5.42 18.78 18.80 18.80	—	—
8	—	—	—	—	—	—	85168 1057A	5.11 18.44	—	—	1077A■ 1013A■ 22641■ 23503*■ 26534*■	18.44 18.54 18.78 18.80 18.80	—	—
9	9752	5.7	—	—	—	—	—	—	—	—	9875	5.42	—	—
11	—	—	—	—	—	—	—	—	—	—	9876	5.42	—	—
12	—	—	—	—	—	—	1058A	18.44	—	—	9877 1078A■ 1014A■ 22676■ 23521*■ 26535*■	5.42 18.44 18.54 18.78 18.80 18.80	—	—
15	9755	5.7	—	—	—	—	—	—	—	—	9879	5.42	—	—
16	—	—	—	—	—	—	1059A	18.44	—	—	1079A■ 22643■ 23532*■ 26536*■	18.44 18.78 18.80 18.80	—	—
20	—	—	—	—	—	—	—	—	—	—	1091A■	18.44	—	—
24	—	—	—	—	—	—	1060A	18.44	—	—	1080A■ 22647■ 23506*■ 26537*■	18.44 18.78 18.80 18.80	—	—
36	—	—	—	—	—	—	1061A	18.44	—	—	1081A■ 22670■ 23544*■ 26538*■	18.44 18.78 18.80 18.80	—	—
50	—	—	—	—	—	—	1062A	18.44	—	—	1082A■ 23575*■ 26546*■	18.44 18.80 18.80	—	—
19 AWG														
1	8486	5.7	—	—	—	—	—	—	—	—	—	—	—	—
18 AWG														
1	8461 9740 89740 87740 87740 82740 9409 9486 8460 1863A	19.36 5.7 5.8 5.9 5.48 5.9 5.48 5.9 5.48 18.46 18.57 19.33 12.34	8790	5.24 19.14	8208	5.23	8760 9460 88760 87760 82760 3076F 9318 1032A 9341 1120A 3088A	5.21 19.14 5.21 5.51 19.14 5.21 5.51 19.14 5.21 5.51 18.19 18.46 18.47 18.57 18.57 18.57	3072F 3073F 3074F	18.18 18.18 18.18	22645■ 23533*■ 26514*■ 22417■ 24511*■ 25506*■ 3088AE 3088CE	18.78 18.80 18.80 18.82 18.83 18.83 18.58 18.58	—	—

▼ Solid conductors * Armored ■ Individually shielded pairs or triads, plus overall foil, overall braid or overall foil and braid. † Triad
 ◆ Siamese version • Duofoil® shield ▽ Quad



Paired Cable

No. of Pairs	Unshielded		Spiral Shield		Braid Shield		Overall Beldfoil®		Overall Foil/Braid		Individual Beldfoil		Individual Braid	
	Part No.	Page	Part No.	Page	Part No.	Page	Part No.	Page	Part No.	Page	Part No.	Page	Part No.	Page
18 AWG (continued)														
2	9156	5.8	—	—	—	—	9552 3025A 1063A	18.46 18.47 18.57	—	—	9368 1474A [■] 1048A [■] 22633 [■] 23511 ^{*■} 26515 ^{*■} 22405 [■] 24512 ^{*■} 25514 ^{*■}	18.46 18.47 18.57 18.78 18.80 18.80 18.82 18.83 18.83	—	—
3	8690	5.8	—	—	—	—	9553 1529A	18.46 18.47	—	—	9773 9369	5.42 18.46	—	—
4	9157	5.8	—	—	—	—	9554 1466A 1064A	18.46 18.47 18.57	—	—	3029A 9388 1475A [■] 1049A [■] 22648 [■] 23530 ^{*■} 26516 ^{*■} 22404 [■] 24513 ^{*■} 25503 ^{*■}	18.46 18.46 18.47 18.57 18.78 18.80 18.82 18.83 18.83	—	—
5	9159	5.8	—	—	—	—	—	—	—	—	—	—	—	—
6	8691	5.8	—	—	—	—	9556	18.46	—	—	9774 9389 22634 [■] 23528 ^{*■} 26517 ^{*■}	5.42 18.46 18.78 18.80 18.80	—	—
8	9161	5.8	—	—	—	—	1467A 1065A	18.47 18.57	—	—	1476A [■] 1050A [■] 22635 [■] 23531 ^{*■} 26518 ^{*■} 22418 [■] 24514 ^{*■} 25505 ^{*■}	18.47 18.57 18.78 18.80 18.80 18.82 18.83 18.83	—	—
9	8692	5.8	—	—	—	—	9559	18.46	—	—	9775 9390	5.42 18.46	—	—
11	—	—	—	—	—	—	9563	18.46	—	—	9391	18.46	—	—
12	9741	5.8	—	—	—	—	1468A 1066A	18.47 18.57	—	—	9776 1477A [■] 1051A [■] 22636 [■] 23524 ^{*■} 26519 ^{*■} 22421 [■] 24515 ^{*■} 25501 ^{*■}	5.42 18.47 18.57 18.78 18.80 18.80 18.82 18.83 18.83	—	—
15	9742	5.8	—	—	—	—	9565	18.46	—	—	9777 9392	5.42 18.46	—	—
16	—	—	—	—	—	—	3034A 1067A	18.47 18.57	—	—	3035A [■] 1052A [■] 22654 [■] 23519 ^{*■} 26520 ^{*■}	18.47 18.57 18.78 18.80 18.80	—	—
19	9743	5.8	—	—	—	—	—	—	—	—	—	—	—	—

▼ Solid conductors * Armored ■ Individually shielded pairs or triads, plus overall foil, overall braid or overall foil and braid. † Triad
 ◆ Siamese version • Duofoil® shield † Quad



Paired Cable

No. of Pairs	Unshielded		Spiral Shield		Braid Shield		Overall Beldfoil®		Overall Foil/Braid		Individual Beldfoil		Individual Braid	
	Part No.	Page	Part No.	Page	Part No.	Page	Part No.	Page	Part No.	Page	Part No.	Page	Part No.	Page
18 AWG (continued)														
24	—	—	—	—	—	—	1471A 1068A	18.47 18.57	—	—	1480A [■] 1053A [■] 22637 [■] 23542 ^{*■} 26521 ^{*■} 22419 [■] 24520 ^{*■} 25517 ^{*■}	18.47 18.57 18.78 18.80 18.80 18.82 18.83 18.83	—	—
36	—	—	—	—	—	—	1472A 1087A	18.47 18.57	—	—	1481A [■] 1054A [■] 23554 ^{*■} 26555 ^{*■}	18.47 18.57 18.80 18.80	—	—
50	—	—	—	—	—	—	3041A 1088A	18.47 18.57	—	—	3042A [■] 1038A [■]	18.47 18.57	—	—
16 AWG														
1	8470 8471 1035A 1307A 1862A 9410 9487 9497	19.33 5.9 19.35 18.49 19.36 21.20 19.33 18.49 18.59 19.33	8780	5.24 19.15	—	—	8719 9316 1030A 1101A 1000A 1018A 1023A 1114A [▼] 1115A [▼] 1116A [▼] 1117A [▼] 83951 83953 9342 1118A 3090A 3090AE 3090CE	5.22 19.15 18.49 18.49 18.54 18.54 18.54 18.54 18.55 18.55 18.55 18.55 18.55 18.55 18.59 18.59 18.60 18.60	—	—	22646 [■] 23501 ^{*■} 26500 ^{*■} 22416 [■] 24500 ^{*■} 25504 ^{*■}	18.79 18.81 18.81 18.82 18.83 18.83	—	—
2	3082K 3082KP	18.24 18.24	—	—	—	—	3043A 1069A	18.49 18.59	—	—	1492A [■] 1055A [■] 22628 [■] 23527 ^{*■} 26501 ^{*■} 22409 [■] 24505 ^{*■} 25510 ^{*■}	18.49 18.59 18.79 18.81 18.81 18.82 18.83 18.83	—	—
3	—	—	—	—	—	—	1528A 1527A	18.49 18.59	—	—	1037A [■]	18.59	—	—
4	—	—	—	—	—	—	1484A 1070A	18.49 18.59	—	—	1493A [■] 1039A [■] 22629 [■] 23509 ^{*■} 26503 ^{*■} 22410 [■] 24502 ^{*■} 25511 ^{*■}	18.49 18.59 18.79 18.81 18.81 18.82 18.83 18.83	—	—
6	—	—	—	—	—	—	—	—	—	—	1040A [■] 22630 [■] 23500 ^{*■} 26504 ^{*■} 22446 [■] 24506 ^{*■} 25512 ^{*■}	18.59 18.79 18.81 18.81 18.82 18.83 18.83	—	—

▼ Solid conductors * Armored ■ Individually shielded pairs or triads, plus overall foil, overall braid or overall foil and braid. † Triad
 ◆ Siamese version • Duofoil[®] shield ▸ Quad



Paired Cable

No. of Pairs	Unshielded		Spiral Shield		Braid Shield		Overall Beldfoil®		Overall Foil/Braid		Individual Beldfoil		Individual Braid	
	Part No.	Page	Part No.	Page	Part No.	Page	Part No.	Page	Part No.	Page	Part No.	Page	Part No.	Page
16 AWG (continued)														
8	—	—	—	—	—	—	1485A 1071A	18.49 18.59	—	—	1494A [■] 1041A [■] 22631 [■] 23510 ^{*■} 26505 ^{*■} 22411 [■] 24503 ^{*■} 25513 ^{*■}	18.49 18.59 18.79 18.81 18.81 18.82 18.83 18.83	—	—
12	—	—	—	—	—	—	1486A 1072A	18.49 18.59	—	—	1495A [■] 1042A [■] 22632 [■] 23525 ^{*■} 26506 ^{*■} 22412 [■] 24504 ^{*■} 25518 ^{*■}	18.49 18.59 18.79 18.81 18.81 18.82 18.83 18.83	—	—
16	—	—	—	—	—	—	3050A 1073A	18.49 18.59	—	—	3051A [■] 1043A [■] 22685 [■] 23539 ^{*■} 26507 ^{*■}	18.49 18.59 18.79 18.81 18.81	—	—
20	—	—	—	—	—	—	—	—	—	—	1044A [■]	18.59	—	—
24	—	—	—	—	—	—	1489A 1074A	18.49 18.59	—	—	1498A [■] 1045A [■] 22686 [■] 23538 ^{*■} 26508 ^{*■} 22447 [■] 24510 ^{*■} 25519 ^{*■}	18.49 18.59 18.79 18.81 18.81 18.82 18.83 18.83	—	—
36	—	—	—	—	—	—	1490A 1089A	18.49 18.59	—	—	1499A [■] 1046A [■] 23568 ^{*■} 26551 ^{*■}	18.49 18.59 18.81 18.81	—	—
50	—	—	—	—	—	—	3056A 1090A	18.49 18.59	—	—	3057A [■] 1047A [■]	18.49 18.59	—	—
14 AWG														
1	8473 9411 9488 3080A 1861A	5.9 19.35 18.51 18.61 18.61 19.34	—	—	—	—	8720 9314 9343	5.22 19.15 18.51 18.61	—	—	—	—	—	—
12 AWG														
1	8477 9412 9489 1311A 21.20 1860A	5.9 19.35 18.52 18.62 19.36 21.20 19.34	—	—	—	—	8718 9312 9344 3103A	5.22 19.15 18.52 18.62 18.62	—	—	—	—	—	—
10 AWG														
1	1313A	19.3 21.20	—	—	—	—	—	—	—	—	—	—	—	—

▼ Solid conductors * Armored ■ Individually shielded pairs or triads, plus overall foil, overall braid or overall foil and braid. † Triad
 ♦ Siamese version • Duofoil® shield ▴ Quad



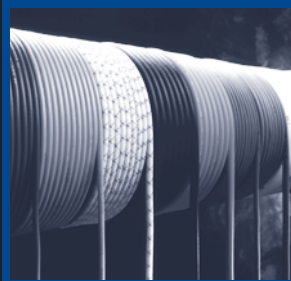

Hook-Up and Lead Wire

Table of Contents

Hook-Up & Lead Wire	Page No.
Introduction: UL Style & CSA Type Listings	3.2
PVC	3.3-3.8
300V, 80°C	3.3
300V, 105°C	3.4
600V, 105°C	3.5
(Type MW) MIL-W-76C-PVC: 1000V, 80°C	3.7
(Type B) MIL-W-16878/1-PVC: 600V, 105°C	3.7
Hook-Up Wire on Racks: Wire Dispenser Kits	3.8
Teflon®	3.9-3.11
300V, 200°C High-Temperature	3.9
105°C High-Temperature	3.10
(Type E) MIL-W-16878/4: 600V, 200°C	3.10
(Type ET) MIL-W-16878/6: 250V, 200°C	3.11
EPDM	3.12-3.13
600V, 150°C High-Temperature	3.12
600V, 125°C High-Temperature	3.13
7500V, 150°C High-Temperature/High-Voltage	3.13
XL-Dur®	3.14-3.15
300V, 105°C	3.14
600V, 125°C	3.14
600V, 150°C High-Temperature	3.15
SIS Wire	3.15
600V, 90°C	3.15
Hypalon®	3.16-3.17
600V, 105°C	3.16
300V, 105°C	3.17
5000V High-Voltage	3.17
Neoprene	3.18
300V, 90°C	3.18
600V, 90°C	3.18
Silicone Rubber	3.19-3.21
Braidless: 600V, 150°C/200°C	3.19
Glass Braid: 600V, 200°C	3.20
Glass Braid: 600V, 150°C	3.21
Mercury Switch Wire: 600V, 150°C	3.21
High-Voltage Leads	3.22
22 AWG, 20 AWG, 18 AWG	3.22
Test Prod Wire: PVC and Rubber Insulation	3.23-3.24
Gas Tube Sign and Ignition Cable	3.24
GTO-10: 10kV, 105°C	3.24
Magnet Wire	3.25
Shielding and Bonding Cable	3.26
Direct Burial Cable: Roadway Loop Cables (14 AWG)	3.26
Bus Bar, Antenna and Aluminum Ground Wire	3.27
Technical Information	3.28-3.32
Conductor and Insulation Materials	3.28
Insulation Characteristics and Color Codes	3.29
Current Carrying Capacity	3.30
Temp Ranges and Classifications/Conductor Configurations	3.31
Packaging	3.32

Hypalon and Teflon are DuPont trademarks.

Please refer to "Terms of Use of Master Catalog" on page 22.22

Introduction

Index by UL Voltage and Temperature Rating

Hook-Up & Lead Wire Section		Page No.
300V, 80°C	PVC	3.3-3.4
300V, 90°C	Neoprene	3.18
300V, 105°C	Hypalon®	3.17
	XL-Dur®	3.14
300V, 200°C	Teflon®	3.9
600V, 90°C	Neoprene	3.18
	SIS	3.15
600V, 105°C	Hypalon	3.16
	PVC	3.5-3.6
600V, 125°C	EPDM	3.12-3.13
	XL-Dur	3.14
600V, 150°C	EPDM	3.12
	Silicone Rubber Braidless	3.19
	Silicone Rubber Glass Braid	3.21
	Silicone Rubber Mercury Switch Wire	3.21
	XL-Dur	3.15
600V, 200°C	Silicone Rubber Braidless	3.19
	Silicone Rubber Glass Braid	3.20
5000V	Hypalon	3.17
7500V, 150°C	EPDM	3.13

Belden® hook-up and lead wire products are manufactured in a variety of materials, sizes and designs to meet rigid industry and government specifications. Manufactured in-house, our hook-up and lead wire manufacturing process begins with copper rod. Our rubber formulation and plastic mixing facilities give us complete control of the product from start to finish. As a result, consistent quality of these products is always assured.

Our hook-up and lead wire products can be used in a wealth of applications including inter-connection circuits, internal wiring of computer and data processing equipment, appliances, lighting, motor leads, heating and cooling equipment, harness fabrication and automotive.

Most of our hook-up and lead wire constructions are available from stock in a wide variety of colors and packages. Many of these are available off the shelf from distributors. If you have a new or unusual application or you cannot find hook-up or lead wire in this catalog section that meets your technical requirements, contact Technical Support at 1-800-BELDEN-1.

Special Ordering Information

Number Printed Wire

Thermosetting and thermoplastic constructions can be supplied with printed numbers. Price and delivery information is available upon request.

Hypalon and Neoprene Constructions

These constructions may require a special topcoat to facilitate printing by customers. Minimum order is 5000' per AWG. Please order the standard item and specify "Top-Coated" and specify color. Orders must be in multiples of standard packages. Price and delivery information is available upon request.

Manufacturer's Identification

Identification of the hook-up and lead wire is provided by our UL and CSA file numbers or printed name on the wire jacket.

UL/CSA	File Number	Style
UL	E-12683	1XXX, 2XXX, 3XXX, 4XXX, 5XXX
	E-9147	GTO 10
	E-6934	SF-1, SFF-1, SF-2, SFF-2
	E-3197	SIS
CSA	LL-7874	All Types

Appliance Wiring Material (AWM)

Appliance Wiring Material is Underwriter Laboratories, Inc.'s recognized covering of insulated wire and cable intended for internal wiring of appliances and equipment. Each construction satisfies the requirements for use in particular applications. Wiring materials recognized under this classification bear the Underwriters' "Appliance Wiring Material Label."

UL & CSA Type by Belden Series

UL Style*	CSA Type	Belden Series Number	Temp. Rating	Page No.
1007	TR-64	328, 99	80°C	3.4
1015	TEW	327, 99, 89	105°C	3.5
1028	TEW	99, 89	105°C	3.6
1061	AWM	99	80°C	3.3
1180	—	830	200°C	3.9
1213	—	830	105°C	3.10
1283	TEW	99	105°C	3.6
1371	—	830	105°C	3.11
1569	TRSR-64	99	105°C	3.4
1855	—	—	80°C	3.24
3044	CL902	315	90°C	3.18
3046	CL903	315, 325	90°C	3.18
3048	CL902	315	90°C	3.18
3049	CL902	315	90°C	3.18
3069	SEWF-2	308	150°C	3.21
3070	SEWF-2	308	150°C	3.21
3071	SEW-2	324	200°C	3.20
3074	SEW-2	324	200°C	3.20
3075	SEW-2	324	200°C	3.20
3101	SEWF-2	308	150°C	3.21
3123	—	340	150°C	3.21
3125	SEW-2	308	200°C	3.20
3126	SEW-2	308	200°C	3.20
3135	—	334	200°C	3.19
3173	CL1251	356	125°C	3.14
3190	CL1052	349	105°C	3.17
3191	CL1052	344	105°C	3.16
3192	CL1052	344	105°C	3.16
3193	CL1052	344	105°C	3.16
3195	CL1251	356	125°C	3.14
3196	CL1251	356	125°C	3.14
3199	CL1054	357	105°C	3.14
3212	AWM	333	150°C	3.19
3213	AWM	333	150°C	3.19
3214	AWM	333	150°C	3.19
3239	—	—	80°C	3.22
3321	AWM	354	150°C	3.15
3340	CL1254	371	150°C	3.12
3374	CL1254	371	150°C	3.12
3436	CL1251	354	150°C	3.15
3484	AWM	372	125°C	3.13
3499	—	375	150°C	3.13
GTO-10	GTO-10	390	105°C	3.24
SIS	—	310	90°C	3.15

*These UL Styles are the Belden product which are listed in this catalog.

Hypalon and Teflon are DuPont trademarks.



PVC

UL AWM Style 1061 300V, 80°C (CSA AWM)

Product Description

Tinned copper, semi-rigid PVC insulation (solid conductors suitable for wire wrap applications).

Solid Conductor

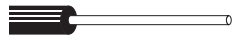

Stranded Conductor



Part No.	AWG (stranding)	Insulation Thickness		Nominal OD		Standard Lengths		Standard Unit Weight		Stock Colors (See Color Codes Chart on Page 3.29)
		Inch	mm	Inch	mm	Ft.	m	Lbs.	kg	
300V, 80°C (UL & CSA)										
UL AWM Style 1061 • CSA AWM										
9978	30 (solid)	.010	.25	.030	.76	100	30.5	.1	.05	1-5, 7-10, 13
						1000	304.8	1.0	.50	1-5, 7-10, 13
9987	30 (7x38)	.010	.25	.032	.81	100	30.5	.1	.05	2, 7-10
						1000	304.8	1.0	.50	2, 7-10
9977	28 (solid)	.010	.25	.033	.84	100	30.5	.1	.05	1-5, 7-10, 13
						1000	304.8	1.0	.50	1-5, 7-10, 13
9986	28 (7x36)	.010	.25	.035	.89	100	30.5	.1	.05	1-5, 7-10, 13
						1000*	304.8	2.0	1.00	1-5, 7-10, 13
						10000*	3048.0	10.0	4.50	2, 4, 10, 13
9976	26 (solid)	.010	.25	.036	.91	100	30.5	.2	.10	1-5, 7-10, 13
						1000*	304.8	2.0	.90	1-5, 7-10, 13
9985	26 (7x34)	.010	.25	.039	.99	100	30.5	.2	.10	1-5, 7-10, 13
						1000*	304.8	2.0	.90	1-5, 7-10, 13
						5000*	1524.0	10.0	4.50	4, 5, 10, 13
9975	24 (solid)	.010	.25	.040	1.02	100	30.5	.2	.10	1-5, 7-10, 13
						1000*	304.8	3.0	1.40	1-5, 7-10, 13
						5000*	1524.0	10.0	4.50	2, 10
9984	24 (7x32)	.010	.25	.044	1.12	100	30.5	.2	.10	1-5, 7-10, 13
						1000*	304.8	3.0	1.40	1-5, 7-10, 13
						5000*	1524.0	10.0	4.50	2, 3, 5, 10, 13
9979	22 (solid)	.010	.25	.047	1.19	1000*	304.8	4.0	1.80	1-5, 7-10, 13
						5000*	1524.0	15.0	6.80	9
9983	22 (7x30)	.010	.25	.050	1.27	100	30.5	.3	.10	1-5, 7-10, 13
						1000*	304.8	4.0	1.80	1-5, 7-10, 13
						5000*	1524.0	15.0	6.80	1, 9, 13
						10000*	3048.0	30.0	13.60	1-3, 9, 10
9982	20 (7x28)	.010	.25	.057	1.45	100	30.5	.5	.20	1-5, 7-10, 13
						1000*	304.8	5.0	2.30	1-5, 7-10, 13
						5000*	1524.0	20.0	9.07	9, 13
9917	20 (10x30)	.010	.25	.056	1.42	1000*	304.8	5.0	2.30	1-4, 7, 9, 10
9911	18 (16x30)	.010	.25	.067	1.70	1000	304.8	7.0	3.20	1-5, 7-10, 13
9981	18 (19x30)	.010	.25	.066	1.68	100	30.5	.8	.40	1-5, 7-10, 13
						1000*	304.8	7.0	3.20	1-5, 7-10, 13
9980	16 (19x28)	.010	.25	.078	1.98	100	30.5	1.3	.60	1-5, 7-10, 13
						1000*	304.8	11.0	5.00	1-5, 7-10, 13
9909	16 (26x30)	.010	.25	.080	2.03	100*	30.5	1.2	.50	3, 7
						1000*	304.8	11.0	5.00	2-5, 7, 9, 10

*Stripe colors on stock solid colors. Striping adder of \$8.00/1000 ft. for one or two stripes. 10,000 ft. minimum order for color combination. Put-up will be subject to two pieces ±10% per spool with a minimum length of 100 ft.

PVC

UL AWM Style 1007 300V, 80°C

(JQA-F-)
VW-1

Product Description

Tinned copper, PVC insulation. Rated 80°C, 300V. Rated 600V peak for electronic circuits, and internal wiring of electronic and electrical equipment.



UL and CSA Dual-Rated Wire

UL AWM Style 1007 — 300V, 80°C
(CSA Type TR-64, 90°C)

UL AWM Style 1569 — 300V, 105°C
(CSA Type TRSR-64, 105°C)

(JQA-F- [except 9989])
VW-1

Product Description

Tinned copper, PVC insulation. Rated 105°C, 300V. Rated 600V peak for electronic circuits, and internal wiring of electronic and electrical equipment.



UL AWM Style 1007 300V, 80°C

(CSA Type TR-64, 90°C)
(JQA-F-)

VW-1

Recommended maximum baking cycles:
24 hours @ 300°F (149°C)



Stranded tinned copper conductor
(Uni-Strand®)

Part No.	AWG (stranding) [sq. mm] (stranding in mm)	Insulation Thickness		Nominal OD		Standard Lengths		Standard Unit Weight		Stock Colors (See Color Codes Chart on Page 3.29)
		Inch	mm	Inch	mm	Ft.	m	Lbs.	kg	

300V, 80°C (UL)

UL AWM Style 1007 • JQA-F-										
9930	30 (7x38)	.015	.38	.044	1.12	100	30.5	.2	.1	1-5, 7-10, 13
						1000*	304.8	2.0	.9	1-5, 7-10, 13

Dual-Rated • 300V, 80°C and 300V, 105°C (UL & CSA)

UL AWM Style 1007 and 1569 • CSA Types TR-64 and TRSR-64 • JQA-F-										
9928	28 (7x36)	.015	.38	.047	1.19	100	30.5	.2	.1	1-5, 7, 9, 10, 13
						1000*	304.8	2.0	.9	1-5, 7-10, 13
						5000*	1524.0	10.0	4.5	4, 10
9926	26 (7x34)	.015	.38	.051	1.30	100	30.5	.2	.1	1-5, 7-10, 13
						1000*	304.8	3.0	1.4	1-5, 7-10, 13
						5000*	1524.0	10.0	4.5	2, 5, 9, 10, 13
9923	24 (7x32)	.015	.38	.056	1.42	100	30.5	.3	.1	1, 2, 4, 5, 9, 10
						1000*	304.8	4.0	1.8	1-5, 7-10, 13
						5000*	1524.0	15.0	6.8	1-5, 7-10, 13
9921	22 (7x30)	.015	.38	.062	1.57	100	30.5	.4	.2	1-10, 13
						1000*	304.8	5.0	2.3	1-10, 13
						5000*	1524.0	20.0	9.1	1-6, 8-10, 13
9919	20 (7x28)	.015	.38	.069	1.75	100	30.5	.7	.3	1-5, 7-10, 13
						1000*	304.8	6.0	2.7	1-5, 7-10, 13
9920	20 (10x30)	.015	.38	.067	1.70	1000*	304.8	6.0	2.7	1-10, 13
						5000*	1524.0	25.0	11.4	2, 6, 9, 10, 13
9918	18 (16x30)	.015	.38	.079	2.01	100	30.5	.9	.4	1-10, 13
						1000*	304.8	8.0	3.6	1-10, 13
						5000*	1524.0	35.0	15.9	1-5, 7-10, 13
9916	16 (26x30)	.015	.38	.092	2.34	100	30.5	1.3	.6	1-5, 7-10, 13
						1000*	304.8	12.0	5.5	1-5, 7-10, 13
						5000*	1524.0	55.0	25.0	1-3, 5, 9, 10

UL AWM Style 1569 • CSA Type TR-64 and TRSR-64

9989	14 (41x30)	.015	.38	.110	2.79	1000*	304.8	17.0	7.7	1-5, 7, 9, 10, 13
------	------------	------	-----	------	------	-------	-------	------	-----	-------------------

300V, 80°C (UL) • 300V, 90°C (CSA)

UL AWM Style 1007 • CSA Type TR-64 • JQA-F-										
32822	22 (7x30) [.36 (7x.25)]	.015	.38	.062	1.58	5000 [†]	1524.0	20.0	9.1	1-5, 7-10, 13
						32820	20 (7x28) [.56 (7x.32)]	.015	.38	.068

*Stripe colors on stock solid colors. Striping adder of \$8.00/1000 ft. for one or two stripes. 10,000 ft. minimum order for color combination. Put-up will be subject to two pieces ±10% per spool with a minimum length of 100 ft.

†May contain more than one piece. Minimum length of any one piece is 200 ft.

PVC

UL AWM Style 1015 600V, 105°C

(CSA Type TEW)
(JQA-F-)

VW-1

Product Description

Tinned copper, PVC insulation. Rated 105°C, 600V. Rated 2500V peak for electronic circuits, and internal wiring of electronic and electrical equipment.



Part No.	AWG (stranding)	Insulation Thickness		Nominal OD		Standard Lengths		Standard Unit Weight		Stock Colors (See Color Codes Chart on Page 3.29)
		Inch	mm	Inch	mm	Ft.	m	Lbs.	kg	

600V, 105°C (UL & CSA)

UL AWM Style 1015 • CSA Type TEW • JQA-F-

9924	24 (7x32)	.030	.76	.088	2.24	100	30.5	.7	.3	1-5, 9, 10, 13
						1000*	304.8	5.0	2.3	1-5, 7-10, 13
						5000	1524.0	25.0	11.4	9, 10
8920	22 (7x30)	.030	.76	.093	2.36	100	30.5	.8	.4	1-5, 9, 10, 13
						1000*	304.8	7.0	3.2	1-5, 7-10, 13
						5000*	1524.0	30.0	13.6	1, 2, 4, 5, 10, 13
8919	20 (10x30)	.030	.76	.100	2.54	100	30.5	.9	.4	1-5, 9, 10, 13
						1000*	304.8	8.0	3.6	1-5, 7-10, 13
						5000*	1524.0	40.0	18.2	2, 4, 9, 10, 13
8918	18 (16x30)	.030	.76	.110	2.79	100	30.5	1.2	.5	1-5, 9, 10, 13, 189
						1000*	304.8	10.0	4.5	1-5, 7-10, 13, 189
						5000*	1524.0	50.0	22.7	1, 2, 4, 5, 7-10, 13
8915	18 (solid)	.030	.76	.105	2.67	1000*	304.8	10.0	4.5	2-5, 8-10, 13
						5000*	1524.0	50.0	22.7	2, 10
8917	16 (26x30)	.030	.76	.123	3.12	100	30.5	2.2	1.0	1-5, 9, 10, 13, 189
						500	152.4	7.5	3.4	1-5, 9, 10, 13
						1000*	304.8	13.0	6.0	1-5, 7-10, 13, 189
						4000	1219.2	56.0	25.4	189
8916	14 (41x30)	.030	.76	.138	3.51	5000*	1524.0	70.0	31.8	1, 2, 5, 9, 10, 13
						100	30.5	2.8	1.3	1-5, 7-10, 13, 189
						500	152.4	10.5	4.8	1-5, 7-10, 13, 189
9912	12 (65x30)	.030	.76	.158	4.01	4000*	1219.2	80.0	36.4	1-5, 7-10, 13
						100	30.5	3.7	1.7	1-5, 7-10, 13
						250	76.2	7.8	3.5	1-5, 8-10, 13
9910	10 (65x28)	.030	.76	.180	4.57	2000	609.6	60.0	27.3	1-5, 9, 10, 13
						100	30.5	5.2	2.4	2, 4, 9, 10
						250	76.2	11.3	5.1	2, 4, 9, 10
8910	10 (105x30)	.030	.76	.186	4.72	2000	609.6	86.0	39.1	2, 9, 10
						500	152.4	22.0	10.0	1-5, 7-10, 13
						2000	609.6	92.0	41.8	1, 3, 4, 8, 10, 13

UL AWM Style 1015 600V, 105°C

(CSA Type TEW)
(JQA-F-)

VW-1

Product Description

Uni-Strand® conductors.

Recommended maximum baking cycles:
48 hours @ 275°F (135°C) • 24 hours @ 300°F (149°C)



Stranded tinned copper conductor (Uni-Strand®)

Part No.	AWG (stranding) [sq. mm] (stranding in mm)	Insulation Thickness		Nominal OD		Standard Lengths		Standard Unit Weight		Stock Colors (See Color Codes Chart on Page 3.29)
		Inch	mm	Inch	mm	Ft.	m	Lbs.	kg	

600V, 105°C (UL & CSA)

UL AWM Style 1015 • CSA Type TEW • JQA-F-

32722	22 (7x30) [.36 (7x.25)]	.030	.76	.093	2.36	5000 [†]	1524.0	35.0	13.9	2, 8, 9, 10
32720	20 (7x28) [.56 (7x.32)]	.030	.76	.099	2.52	4000 [†]	1219.2	28.0	12.7	1-5, 9, 10, 13
32718	18 (7x26) [.90 (7x.40)]	.032	.80	.108	2.74	4000 [†]	1219.2	40.0	18.2	2-5, 7, 9, 10, 13

*Stripe colors on stock solid colors. Striping adder of \$8.00/1000 ft. for one or two stripes. 10,000 ft. minimum order for color combination. Put-up will be subject to two pieces ±10% per spool with a minimum length of 100 ft.

[†]May contain more than one piece. Minimum length of any one piece is 200 ft.

PVC

UL AWM Style 1028 and 1015 600V, 105°C

(CSA Type TEW)

VW-1

Product Description

Tinned copper, PVC insulation.



Part No.	AWG (stranding)	Insulation Thickness		Nominal OD		Standard Lengths		Standard Unit Weight		Stock Colors (See Color Codes Chart on Page 3.29)
		Inch	mm	Inch	mm	Ft.	m	Lbs.	kg	

600V, 105°C (UL & CSA)

UL AWM Style 1028 and 1015 • CSA Type TEW

9908	8 (84x27)	.045	1.14	.250	6.35	100	30.5	8.0	3.6	2, 4, 9, 10
						250	76.2	19.0	8.7	2, 9, 10
8908	8 (133x29)	.045	1.14	.262	6.65	250	76.2	18.5	8.4	1-5, 7-10, 13
						1500	457.2	115.5	52.4	2, 4, 5, 7, 8, 10

600V, 105°C (UL & CSA)

UL AWM Style 1283 and 1015 • CSA Type TEW

9906	6 (133x27)	.060	1.52	.331	8.41	100	30.5	11.7	5.3	1-5, 7-10, 13
						1000	304.8	122.0	55.5	1-5, 8-10, 13
9904	4 (133x25)	.060	1.52	.392	9.96	50	15.2	11.2	5.1	1-5, 7-10, 13
						500	152.4	100.5	45.7	1, 2, 4, 9, 10

UL AWM Style 1283 and 1015 600V, 105°C

(CSA Type TEW)

VW-1

Product Description

Tinned copper, PVC insulation.



PVC

(Type MW) MIL-W-76C-PVC 1000V, 80°C**

Product Description

Tinned copper, PVC insulation, medium wall. The extruded PVC insulation is flame and ozone resistant and inert to most chemicals, oils, and solvents. Covers single conductor, PVC insulation hook-up wire for internal wiring of electrical and electronic equipment.

Solid Conductor



Stranded Conductor



(Type B) MIL-W-16878/1-PVC 600V, 105°C**

Product Description

Tinned copper, PVC insulation. Covers insulated wire for internal wiring of meters, panels, and electrical or electronic equipment. Temperatures to 105°C. For high-temperature MIL-Spec hook-up wire, see pages 3.9 to 3.11.



Part No.	AWG (stranding)	Insulation Thickness		Nominal OD		Standard Lengths		Standard Unit Weight		Stock Colors (See Color Codes Chart on Page 3.29)
		Inch	mm	Inch	mm	Ft.	m	Lbs.	kg	
1000V, 80°C (MIL-Spec)										
(Type MW) MIL-W-76C-PVC										
8538	24 (solid)	.017	0.43	.055	1.40	100	30.5	.3	.1	1-10
	MW-C24 (1) A					1000*	304.8	4.0	1.8	1-10
8525	24 (7x32)	.017	0.43	.058	1.47	100	30.5	.3	.1	1-21
	MW-C24 (7) A					1000	304.8	4.0	1.8	1-13,* 14-21
8530	22 (solid)	.017	0.43	.059	1.50	100	30.5	.4	.2	1-13
	MW-C22 (1) A					1000*	304.8	4.0	1.8	1-13
8524	22 (7x30)	.017	0.43	.064	1.63	100	30.5	.4	.2	1-30
	MW-C22 (7) A					1000	304.8	5.0	2.3	1-13,* 14-30
8529	20 (solid)	.017	0.43	.066	1.68	100	30.5	.7	.3	1-10, 13
	MW-C20 (1) A					1000*	304.8	6.0	2.7	1-10, 13
8523	20 (10x30)	.017	0.43	.070	1.78	100	30.5	.7	.3	1-24, 27, 29, 30
	MW-C20 (10) A					1000	304.8	6.0	2.7	1-13,* 14-24, 30
8522	18 (16x30)	.017	0.43	.080	2.03	100	30.5	.9	.4	1-30
	MW-C18 (16) A					1000	304.8	8.0	3.6	1-13,* 14-24, 26, 28, 30
8521	16 (26x30)	.019	0.48	.098	2.49	100	30.5	1.4	.6	1-22
	MW-C16 (26) A					1000	304.8	12.0	5.5	1-13,* 14-22
8520	14 (41x30)	.018	0.46	.111	2.82	100	30.5	1.9	.9	1-11, 13-16, 18, 19
	MW-C14 (41) A					1000	304.8	17.0	7.7	1-10,* 13,* 14-17, 18, 20
8527	12 (65x30)	.018	0.46	.128	3.25	100	30.5	3.3	1.5	1-7, 9, 10
	MW-C12 (65) A					1000*	304.8	24.0	10.9	1-10

*Stripe colors on stock solid colors. Striping adder of \$8.00/1000 ft. for one or two stripes. 10,000 ft. minimum order for color combination. Put-up will be subject to two pieces ±10% per spool with a minimum length of 100 ft.

**Certification available upon special request.

600V, 105°C (MIL-Spec)

(Type B) MIL-W-16878/1-PVC										
8597	28 (7x36)	.010	.25	.035	.89	100	30.5	.1	.1	1-10
	B-28					1000	304.8	1.0	.5	1-10
8505	26 (7x34)	.010	.25	.039	.99	100	30.5	.2	.1	1-10, 14-22
	B-26					1000	304.8	1.0	.5	1-10,* 14-18, 20
8504	24 (7x32)	.010	.25	.044	1.12	100	30.5	.2	.1	1-10, 14-22
	B-24					1000	304.8	2.0	.9	1-10,* 14-20, 22
8503	22 (7x30)	.010	.25	.050	1.27	100	30.5	.3	.1	1-10, 14-22
	B-22					1000	304.8	3.0	1.4	1-10,* 14-22
8502	20 (7x28)	.010	.25	.058	1.47	100	30.5	.5	.2	1-10, 14-16, 18-20
	B-20					1000	304.8	4.0	1.8	1-10,* 14-16, 18-20
8501	18 (7x26)	.010	.25	.068	1.73	100	30.5	.9	.4	1-10, 14-18, 20-22
	B-18					1000	304.8	7.0	3.2	1-10,* 14-18, 20-22
8500	16 (19x29)	.010	.25	.079	2.01	100	30.5	1.2	.5	1-10, 14-22
	B-16					1000	304.8	10.0	4.5	1-10,* 14-22

*Stripe colors on stock solid colors. Striping adder of \$8.00/1000 ft. for one or two stripes. 10,000 ft. minimum order for color combination. Put-up will be subject to two pieces ±10% per spool with a minimum length of 100 ft.

**Certification available upon special request.

PVC

Hook-Up Wire on Racks

Wire Dispenser Kits

Product Description

Great for R and D labs, engineers, servicemen and hobbyists.

Specify Part No. 8800 for Rack only.



Part No.	No. of Spools	Type of Wire (Part No.)	Temp. Rating	AWG (stranding)	Spool Lengths		Standard Unit Weight		Colors in Kits (See Color Codes Chart on Page 3.29)
					Ft.	m	Lbs.	kg	
Wire Dispenser Kits									
Hook-Up Wire on Racks									
8816	8	Tinned PVC (8522)	80°C	18 (16x30)	25	7.6	2.5	1.1	1,2,3,4,5,6,9,10
8824	8	Tinned PVC (8523)	80°C	20 (10x30)	25	7.6	2.1	1.0	1,2,3,4,5,6,9,10
8825	5	Tinned PVC (8502)	105°C	20 (7x28)	100	30.5	3.1	1.4	2,4,5,9,10
9531	5	Tinned PVC (8524)	80°C	22 (7x30)	100	30.5	2.7	1.2	2,5,6,9,10

Teflon®

High-Temperature

UL AWM Style 1180
300V, 200°C
 (Type EE) MIL-W-16878/5
 Teflon — 1000V, 200°C
 VW-1

Product Description

Stranded silver-coated copper conductor insulation with extruded TFE Teflon.



Part No.	AWG (stranding)	Insulation Thickness		Nominal OD		Standard Lengths		Standard Unit Weight		Stock Colors (See Color Codes Chart on Page 3.29)
		Inch	mm	Inch	mm	Ft.	m	Lbs.	kg	
300V, 200°C (UL) • 1000V, 200°C (MIL-Spec)										
UL AWM Style 1180 • (Type EE) MIL-W-16878/5 — Teflon										
83023*	24 (19x36)	.015	.38	.053	1.35	100 [†]	30.5	.4	.2	1-10
						500 [▲]	152.4	2.5	1.1	2, 4, 5, 9, 10
						1000 [▲]	304.8	4.0	1.8	1-10
83025	22 (7x30)	.015	.38	.060	1.52	100 [†]	30.5	.5	.2	1-7, 9, 10
						500 [▲]	152.4	3.0	1.4	2, 9, 10
						1000 [▲]	304.8	5.0	2.3	1-7, 9, 10
83026*	22 (19x34)	.015	.38	.059	1.50	100 [†]	30.5	.5	.2	1-10
						500 [▲]	152.4	3.0	1.4	2, 9, 10
						1000 [▲]	304.8	5.0	2.3	1-10
83027*	20 (19x32)	.015	.38	.068	1.73	100 ^{††}	30.5	.8	.4	1-10
						500 [▲]	152.4	4.0	1.8	2, 9, 10
						1000 [▲]	304.8	7.0	3.2	1-10
83028	20 (7x28)	.015	.38	.068	1.73	100 ^{††}	30.5	.8	.4	1-10
						500 [▲]	152.4	4.0	1.8	2, 9, 10
						1000 [▲]	304.8	7.0	3.2	1-10
83029*	18 (19x30)	.015	.38	.077	1.96	100 ^{††}	30.5	1.1	.5	1-10
						500 [▲]	152.4	5.5	2.5	2, 5, 6, 9, 10
						1000 [▲]	304.8	9.0	4.1	1-10
83030*	16 (19x29)	.015	.38	.088	2.24	100 ^{††}	30.5	1.3	.6	1-10
						500 [▲]	152.4	6.5	3.0	2, 9, 10
						1000 [▲]	304.8	12.0	5.4	1-10

*Complies with MIL-W-16878 except stranding.
[†]100 ft. put-ups are exact, but may contain 2 pieces max.
^{††}100 ft. put-ups are exact, one piece.
[▲]May contain more than one piece. Minimum length of any one piece is 25 ft.

Teflon is a DuPont trademark.



Teflon®

High-Temperature

UL AWM Style 1213 — 105°C

(Type E) MIL-W-16878/4

Teflon — 600V, 200°C

VW-1

Product Description

Stranded silver-coated copper conductor insulation with extruded TFE Teflon.



Part No.	AWG (stranding)	Insulation Thickness		Nominal OD		Standard Lengths		Standard Unit Weight		Stock Colors (See Color Codes Chart on Page 3.29)
		Inch	mm	Inch	mm	Ft.	m	Lbs.	kg	

105°C (UL) • 600V, 200°C (MIL-Spec)

UL AWM Style 1213 • (Type E) MIL-W-16878/4 — Teflon

83000	30 (7x38)	.010	.25	.032	.81	100 †	30.5	.1	.05	1-10
						1000 ▲	304.8	1.0	.50	1-10
83001*	28 (7x36)	.010	.25	.035	.89	100 †	30.5	.2	.10	1-10
						1000 ▲	304.8	2.0	.90	1-10
83002	26 (7x34)	.010	.25	.039	.99	100 †	30.5	.2	.10	1-10
						500 ▲	152.4	1.0	.50	9
						1000 ▲	304.8	3.0	1.40	1-10
83003*	24 (19x36)	.010	.25	.043	1.09	100 †	30.5	.3	.10	1-10
						500 ▲	152.4	1.5	.70	1-10
						1000 ▲	304.8	3.0	1.40	1-10
83004	24 (7x32)	.010	.25	.043	1.09	100 †	30.5	.3	.10	1-10
						500 ▲	152.4	1.5	.70	2, 10
						1000 ▲	304.8	3.0	1.40	1-10
83005	22 (7x30)	.010	.25	.049	1.24	100 †	30.5	.4	.20	1-10
						500 ▲	152.4	2.5	1.10	2, 9, 10
						1000 ▲	304.8	4.0	1.80	1-10
83006*	22 (19x34)	.010	.25	.048	1.22	100 †	30.5	.4	.20	1-10
						500 ▲	152.4	2.5	1.10	1-10
						1000 ▲	304.8	4.0	1.80	1-10
83007*	20 (19x32)	.010	.25	.056	1.42	100 ††	30.5	.5	.20	1-10
						500 ▲	152.4	3.5	1.60	2, 6, 9, 10
						1000 ▲	304.8	6.0	2.70	1-10
83008	20 (7x28)	.010	.25	.058	1.47	100 †	30.5	.5	.20	1-10
						500 ▲	152.4	3.5	1.60	1-10
						1000 ▲	304.8	6.0	2.70	1-10

*Complies with MIL-W-16878 except stranding.

†100 ft. put-ups are exact, but may contain 2 pieces max. Minimum length of any one piece is 25 ft.

††100 ft. put-ups are exact, one piece.

▲May contain more than one piece. Length may vary ±10% from length shown.

Teflon is a DuPont trademark.



For more information, contact Belden Technical Support: 1-800-BELDEN-1 • www.belden.com

Teflon® High-Temperature

UL AWM Style 1371 — 105°C

(Type E) MIL-W-16878/4
Teflon — 600V, 200°C

VW-1

Product Description

Stranded silver-coated copper conductor insulation with extruded TFE Teflon.



UL AWM Style 1371 — 105°C

(Type ET) MIL-W-16878/6
Teflon — 250V, 200°C

VW-1

Product Description

Stranded silver-coated copper conductor insulation with extruded TFE Teflon.



Part No.	AWG (stranding)	Insulation Thickness		Nominal OD		Standard Lengths		Standard Unit Weight		Stock Colors (See Color Codes Chart on Page 3.29)
		Inch	mm	Inch	mm	Ft.	m	Lbs.	kg	

105°C (UL) • 600V, 200°C (MIL-Spec)

UL AWM Style 1371 • (Type E) MIL-W-16878/4 — Teflon										
83009*	18 (19x30)	.011	.28	.068	1.73	100 [†]	30.5	1.0	.5	1-10
						500 [▲]	152.4	4.5	2.0	1-10
						1000 [▲]	304.8	8.0	3.6	1-10
83010*	16 (19x29)	.012	.30	.076	1.93	100 [†]	30.5	1.2	.5	1-10
						500 [▲]	152.4	6.0	2.7	1-10
						1000 [▲]	304.8	11.0	5.0	1-10

*Complies with MIL-W-16878 except stranding.

[†]100 ft. put-ups are exact, one piece.

[▲]May contain more than one piece. Length may vary ±10% from length shown.

105°C (UL) • 250V, 200°C (MIL-Spec)

UL AWM Style 1371 • (Type ET) MIL-W-16878/6 — Teflon										
83041	32 (7x40)	.006	.15	.022	.56	100 ^{††}	30.5	.1	.05	6, 7, 10
						1000 [▲]	304.8	1.0	.50	6, 7, 10
83043	30 (7x38)	.006	.15	.024	.61	100 ^{††}	30.5	.1	.05	2, 5, 7-10
						1000 [▲]	304.8	1.0	.50	2, 5, 7, 9, 10
83045	28 (7x36)	.006	.15	.027	.69	100 ^{††}	30.5	.1	.051, 2, 5, 6, 9, 10	
						1000 [▲]	304.8	1.0	.501, 2, 5, 6, 9, 10	
83046	26 (7x34)	.006	.15	.031	.79	100 ^{††}	30.5	.2	.10	1-4, 6-9
						1000 [▲]	304.8	2.0	.90	1-4, 6-10
83047	24 (7x32)	.006	.15	.036	.91	100 ^{††}	30.5	.2	.10	6, 8-10
						1000 [▲]	304.8	2.0	.90	2, 6, 8-10
83048	24 (19x36)	.006	.15	.036	.91	100 ^{††}	30.5	.2	.101-3, 5, 7, 8, 10	
						1000 [▲]	304.8	2.0	.901-3, 5, 7, 8, 10	
83049	22 (7x30)	.006	.15	.042	1.07	100 ^{††}	30.5	.3	.10	1-10
						1000 [▲]	304.8	4.0	1.80	1-10
83050	22 (19x34)	.006	.15	.042	1.07	100 ^{††}	30.5	.3	.10	1-3, 5-9
						1000 [▲]	304.8	4.0	1.80	1-3, 5-9

^{††}100 ft. put-ups are exact, max. 2 pieces. Minimum length of any one piece is 25 ft.

[▲]May contain more than one piece. Length may vary ±10% from length shown.

Teflon is a DuPont trademark.



For more information, contact Belden Technical Support: 1-800-BELDEN-1 • www.belden.com

EPDM

High-Temperature

UL AWM Style 3340 and 3374 600V, 125°C Flex/150°C No Flex (CSA Type CL1254)

Product Description

The insulation used for this High-Temperature lead wire is a chemically cross-linked ethylene-propylene diene elastomer. Never before could you find many of the characteristics that are found in Silicone and Hypalon® combined into one insulation. This 150°C EPDM wire offers more abrasion resistance than Hypalon... has the temperature rating of Silicone... at a price less than Silicone. EPDM has exceptional qualities that help you achieve new levels of economy and quality. 150°C EPDM wire is recommended for Class 130(B), 155(F) and also in some 180(H) systems. It's UL Recognized under Style 3374 as a 150°C—600V Appliance Wiring Material. The CSA Listing, as a coil lead, is 125°C, 600V. For additional technical information, see Technical Information pages at the end of this section.

Recommended maximum baking cycles:
24 hours @ 350°F (177°C) • 4 hours @ 375°F (190°C)

Stranded Conductor



Stranded tinned copper conductor

Separator Over Conductor



Separator

Part No.	AWG (stranding) [sq. mm] (stranding in mm)	Insulation Thickness		Nominal OD		Standard Lengths		Standard Unit Weight		Stock Colors (See Color Codes Chart on Page 3.29)
		Inch	mm	Inch	mm	Ft.	m	Lbs.	kg	
600V, 125°C Flex/150°C No Flex (UL) • 600V, 125°C (CSA)										
UL AWM Style 3340 and 3374 • CSA Type CL1254										
37118	18 (16x30) [.82 (16x.25)]	.045	1.14	.142	3.61	500 [†]	152.4	7.5	3.4	2, 4, 5, 9, 10, 13
						5000 ^{††}	1524.0	70.0	31.8	2, 9, 10, 13
37116	16 (26x30) [1.32 (26x.25)]	.045	1.14	.154	3.91	500 [†]	152.4	9.5	4.3	2, 4, 5, 9, 10, 13
						4000 ^{††}	1219.2	72.0	32.7	10
						5000 ^{††}	1524.0	90.0	40.9	10
37114	14 (41x30) [2.08 (41x.25)]	.045	1.14	.169	4.29	500 [†]	152.4	12.5	5.7	2, 10
						4000 ^{††}	1219.2	96.0	43.6	2, 10
						5000 ^{††}	1524.0	125.0	56.8	10
37112	12 (65x30) [3.29 (65x.25)]	.045	1.14	.190	4.83	500 [†]	152.4	16.5	7.5	2, 10
						3000 ^{††}	914.4	105.0	47.7	10
						5000 ^{††}	1524.0	175.0	79.5	10
37110	10 (65x28) [5.23 (65x.32)]	.060	1.52	.240	6.10	500 [†]	152.4	26.0	11.8	10
						2000 ^{††}	609.6	108.0	49.2	10
						5000 ^{††}	1524.0	275.0	125.0	10
37108*	8 (84x27) [8.60 (84x.36)]	.080	2.03	.327	8.31	250 ^{**}	76.2	22.5	10.2	10
						500 [†]	152.4	48.0	21.8	10
						2500	762.0	235.0	106.8	10
37106*	6 (84x25) [13.66 (84x.46)]	.080	2.03	.383	9.73	100 [*]	30.5	14.2	6.5	10
						250 ^{**}	76.2	33.0	15.0	10
						500 [†]	152.4	69.0	31.3	10
						2500	762.0	345.0	156.8	10
37104*	4 (105x24) [21.53 (105x.51)]	.080	2.03	.432	10.97	100 [*]	30.5	18.7	8.5	10
						250 ^{**}	76.2	50.0	22.7	10
						500 [†]	152.4	98.5	44.8	10
1000	304.8	196.0	89.1	10						
37103*	3 (133x24) [27.28 (133x.51)]	.080	2.03	.453	11.51	100 [*]	30.5	22.7	10.3	10
						250 ^{**}	76.2	61.8	28.1	10
37102*	2 (163x24) [33.43 (163x.51)]	.080	2.03	.494	12.55	100 [*]	30.5	31.1	14.1	10
						250 ^{**}	76.2	72.3	32.8	10
						1000	304.8	286.0	130.0	10
37101*	1 (210x24) [43.07 (210x.51)]	.095	2.41	.583	14.81	100 [*]	30.5	41.0	18.6	10
						250 ^{**}	76.2	95.0	43.2	10
						1000	304.8	376.0	170.9	10
37190*	1/0 (262x24) [53.73 (262x.51)]	.095	2.41	.633	16.08	50	15.2	24.7	11.2	10
						100 [*]	30.5	48.3	22.0	10
						250 ^{**}	76.2	115.5	52.5	10
500	152.4	223.5	101.6	10						
37100*	2/0 (504x26) [67.85 (504x.41)]	.095	2.41	.698	17.73	50	15.2	30.9	14.0	10
						100 [*]	30.5	58.8	26.7	10
						250 ^{**}	76.2	141.8	64.4	10
500	152.4	279.5	127.0	10						
37130*	3/0 (630x26) [84.81 (630x.41)]	.095	2.41	.758	19.25	50	15.2	38.5	17.5	10
						250 ^{**}	76.2	174.0	79.1	10
						500	152.4	346.0	157.3	10
37140*	4/0 (805x26) [108.37 (805x.41)]	.095	2.41	.849	21.57	50	15.2	44.6	20.2	10
						250 ^{**}	76.2	215.8	98.1	10
						500	152.4	449.0	203.7	10

*Separator over conductor.

[†]May contain more than one piece. Length may vary ±10% from length shown.

^{††}May contain more than one piece. Minimum length of any one piece is 200 ft.

*100 ft. put-ups are exact, one piece.

**200 ft. put-ups are exact, but may contain 2 pieces max. Minimum length of any one piece is 50 ft.



EPDM

High-Temperature

UL AWM Style 3484 600V, 125°C (CSA Type AWM)

Product Description

This series of EPDM (ethylene-propylene diene elastomer) will provide you with a lead wire which possesses excellent characteristics. The reduced wall thickness results in a UL and CSA Rating of 600V, 125°C. For additional technical information, see Technical Information pages at the end of this section.



Stranded tinned copper conductor

UL AWM Style 3499 7500V, 150°C High-Voltage EPDM

Product Description

The insulation used for this High-Voltage wire is a chemically cross-linked ethylene-propylene diene elastomer with a separator for improved strippability. EPDM is naturally corona resistant and more heat resistant than many other rubber compounds and is able to take the longer bake cycles frequently needed for the big jobs. EPDM has superior weather resistance and low temperature pliability. EPDM is used in many high voltage applications. For additional technical information, see Technical Information pages at the end of this section.

Recommended maximum baking cycles:
24 hours @ 350°F (177°C) • 4 hours @ 375°F (190°C)



Separator
Stranded tinned copper conductor

Part No.	AWG (stranding) [sq. mm] (stranding in mm)	Insulation Thickness		Nominal OD		Standard Lengths		Standard Unit Weight		Stock Colors (See Color Codes Chart on Page 3.29)
		Inch	mm	Inch	mm	Ft.	m	Lbs.	kg	

600V, 125°C (UL & CSA)

UL AWM Style 3484 • CSA Type AWM										
37222	22 (7x30) [.36 (7x.25)]	.030	.76	.093	2.36	*	*	*	*	Special Order*
37220	20 (10x30) [.51 (10x.25)]	.030	.76	.102	2.59	*	*	*	*	Special Order*
37218	18 (16x30) [.81 (16x.25)]	.030	.76	.109	2.77	*	*	*	*	Special Order*
37216	16 (26x30) [1.32 (26x.25)]	.030	.76	.123	3.12	*	*	*	*	Special Order*
37214	14 (41x30) [2.08 (41x.25)]	.030	.76	.138	3.51	*	*	*	*	Special Order*
37212	12 (65x30) [3.29 (65x.25)]	.030	.76	.158	4.01	*	*	*	*	Special Order*

*Contact Belden's Customer Service Department for order requirements. 1-800-BELDEN-1.

7500V, 150°C (UL)

UL AWM Style 3499										
37508	8 (84x27) [8.60 (84x.36)]	.125	3.18	.423	10.74	50 *	15.2	9.6	4.4	10
						500 ††	152.4	66.0	30.0	10
						1000 ††	304.8	130.0	59.1	10
37506	6 (84x25) [13.66 (84x.46)]	.125	3.18	.470	11.94	50 *	15.2	11.8	5.3	10
						500 ††	152.4	90.0	40.9	10
						1000 ††	304.8	176.0	80.0	10
37504	4 (105x24) [21.53 (105x.51)]	.125	3.18	.526	13.36	50 *	15.2	15.0	6.8	10
						500 ††	152.4	122.0	55.5	10
						1000 ††	304.8	240.0	109.1	10
37502	2 (163x24) [33.43 (163x.51)]	.125	3.18	.581	14.76	50 *	15.2	19.4	8.8	10
						500 ††	152.4	167.5	76.0	10
						1000 ††	304.8	333.0	151.4	10
37501	1 (210x24) [43.07 (210x.51)]	.125	3.18	.638	16.21	50 *	15.2	23.1	10.5	10
						500 ††	152.4	206.0	93.6	10
						250 †	76.2	123.5	56.1	10
37590	1/0 (262x24) [53.73 (262x.51)]	.125	3.18	.688	17.48	50 *	15.2	27.3	12.4	10
						250 †	76.2	123.5	56.1	10
						500 ††	152.4	243.0	110.5	10
37500	2/0 (504x26) [67.85 (504x.41)]	.125	3.18	.753	19.13	50 *	15.2	34.2	15.5	10
						250 †	76.2	150.5	68.4	10
						500 ††	152.4	302.5	137.5	10
37530	3/0 (630x26) [84.81 (630x.41)]	.125	3.18	.813	20.65	50 *	15.2	40.5	18.4	10
						250 †	76.2	184.0	83.6	10
						500 ††	152.4	368.0	167.2	10
37540	4/0 (805x26) [108.37 (805x.41)]	.125	3.18	.909	23.09	50 *	15.2	48.7	22.1	10
						250 †	76.2	228.8	104.0	10
						500 ††	152.4	457.6	208.0	10

*50 ft. put-ups are one piece, exact.

†250 ft. put-ups are exact, but may contain 2 pieces max. Minimum length of any one piece is 50 ft.

††May contain more than one piece. Length may vary ±10% from length shown.

XL-Dur®

UL AWM Style 3199 300V, 105°C (CSA Type CL1054)

Product Description

This insulation is a chemically cross-linked polyethylene applied in a single extrusion. This construction has excellent thermal aging characteristics, moisture resistance, and solvent resistance. It provides an economic alternative to Hypalon® where extreme flexibility is not required. The insulation resists deformation when subjected to momentary high temperatures in customer assembly processes.

Recommended maximum baking cycles:

24 hours @ 300°F (149°C) • 12 hours @ 325°F (163°C)
8 hours @ 350°F (177°C)



Stranded tinned copper conductor

UL AWM Style 3173, 3195, 3196 600V, 125°C (CSA Type CL1251)

Product Description

This insulation is a chemically cross-linked polyethylene applied in a single extrusion. This construction has excellent thermal aging characteristics, moisture resistance, and solvent resistance. It provides an economic alternative to Hypalon where extreme flexibility is not required. The insulation resists deformation when subjected to momentary high temperatures in customer assembly processes. The 356-series of XL-DUR is recommended for Class 130(B) as motor leads.

Recommended maximum baking cycles:

24 hours @ 300°F (149°C) • 12 hours @ 325°F (163°C)
8 hours @ 350°F (177°C)

Stranded Conductor



Stranded tinned copper conductor

Separator Over Conductor



Separator

Hypalon is a DuPont trademark.

Part No.	AWG (stranding) [sq. mm] (stranding in mm)	Insulation Thickness		Nominal OD		Standard Lengths		Standard Unit Weight		Stock Colors (See Color Codes Chart on Page 3.29)
		Inch	mm	Inch	mm	Ft.	m	Lbs.	kg	

300V, 105°C (UL & CSA)

UL AWM Style 3199 • CSA Type CL1054										
35722	22 (7x30) [.36 (7x.25)]	.015	.38	.062	1.58	*	*	*	*	Special Order*
35720	20 (10x30) [.51 (10x.25)]	.015	.38	.073	1.85	*	*	*	*	Special Order*
35718	18 (19x30.5) [.83 (19x.24)]	.015	.38	.078	1.98	5000 ^{††}	1524.0	40.0	18.2	1, 5, 6, 9, 10
35716	16 (19x29) [1.23 (19x.29)]	.015	.38	.091	2.31	*	*	*	*	Special Order*

*Contact Belden's Customer Service Department for order requirements. 1-800-BELDEN-1.

††May contain more than one piece. Minimum length of any one piece is 200 ft.

600V, 125°C (UL & CSA)

UL AWM Style 3173 • CSA Type CL1251										
35622	22 (7x30) [.36 (7x.25)]	.030	.76	.093	2.36	5000 ^{††}	1524.0	30.0	13.6	2, 9, 10
35620	20 (10x30) [.51 (10x.25)]	.030	.76	.101	2.57	500 [†]	152.4	4.5	2.0	10
						5000 ^{††}	1524.0	40.0	18.2	2, 6, 9, 10
35618	18 (16x30) [.81 (16x.25)]	.030	.76	.109	2.77	500 [†]	152.4	5.5	2.5	2, 4, 5, 10, 13
						5000 ^{††}	1524.0	50.0	22.7	1-10, 12, 13
35616	16 (26x30) [1.32 (26x.25)]	.030	.76	.122	3.10	500 [†]	152.4	7.5	3.4	2, 4, 5, 9, 10
						5000 ^{††}	1524.0	75.0	34.1	1-6, 8-10, B02
35614	14 (41x30) [2.08 (41x.25)]	.030	.76	.137	3.48	500 [†]	152.4	10.5	4.8	10
						5000 ^{††}	1524.0	100.0	45.4	2, 5, 6, 9, 10
35612	12 (65x30) [3.29 (65x.25)]	.030	.76	.153	3.89	500 [†]	152.4	15.0	6.8	10
						3000 ^{††}	914.4	87.0	39.5	9, 10
35610	10 (65x28) [5.23 (65x.32)]	.030	.76	.177	4.50	2000 [†]	609.6	86.0	39.1	9, 10
UL AWM Style 3195 • CSA Type CL1251										
35608**	8 (133x29) [8.60 (133x.29)]	.045	1.14	.263	6.68	2000 [†]	609.6	152.0	69.0	9, 10
UL AWM Style 3196 • CSA Type CL1251										
35606**	6 (133x27) [13.61 (133x.36)]	.060	1.52	.333	8.46	2000 [†]	609.6	244.0	110.7	9, 10

**Separator over conductor.

[†]May contain more than one piece. Minimum length of any one piece is 50 ft.

^{††}May contain more than one piece. Minimum length of any one piece is 200 ft.

XL-Dur® (High-Temperature) and SIS (Switchboard) Wire

UL AWM Style 3436 and 3321 XL-Dur — 600V, 150°C (CSA Type CL1251 and AWM)

Product Description

This series of chemically cross-linked polyethylene lead wire is available for higher temperature applications. It is UL Recognized to 600V, 150°C. As with other cross-linked lead wire, it has excellent heat aging characteristics in combination with excellent electrical and physical properties.



Stranded tinned copper conductor

UL Type SIS — 600V, 90°C (UL)

Product Description

For wiring switchboards, panelboards, distribution boards, including instrument and control wiring in these applications. The wire is covered by a separator for improved strippability.



Separator
Stranded tinned copper conductor

Part No.	AWG (stranding) [sq. mm] (stranding in mm)	Insulation Thickness		Nominal OD		Standard Lengths		Standard Unit Weight		Stock Colors (See Color Codes Chart on Page 3.29)
		Inch	mm	Inch	mm	Ft.	m	Lbs.	kg	

600V, 150°C (UL & CSA)

UL AWM Style 3436 and 3321 • CSA Type CL1251 and AWM										
35420	20 (10x30) [.51 (10x.25)]	.030	.76	.102	2.59	500 [†]	152.4	4.5	2.0	9
35418	18 (16x30) [.81 (16x.25)]	.030	.76	.110	2.79	500 [†]	152.4	5.5	2.5	9, 10
						5000 [†]	1524.0	50.0	22.7	10
35416	16 (26x30) [1.32 (26x.25)]	.030	.76	.123	3.12	500 [†]	152.4	7.5	3.4	9, 10
						5000 [†]	1524.0	70.0	31.8	9, 10
35414	14 (41x30) [2.08 (41x.25)]	.030	.76	.138	3.51	500 [†]	152.4	10.0	4.5	9, 10
						5000 [†]	1524.0	95.0	43.2	9, 10
35412	12 (65x30) [3.29 (65x.25)]	.030	.76	.153	3.89	500 [†]	152.4	14.5	6.6	9, 10
						5000 [†]	1524.0	140.0	63.6	9, 10
35410	10 (65x28) [5.23 (65x.32)]	.030	.76	.177	4.50	500 [†]	152.4	20.0	9.1	9, 10
						5000 [†]	1524.0	210.0	95.5	9, 10

[†]Spools may contain more than one piece. Length may vary ±10% from length shown.

600V, 90°C (UL)

UL Type SIS • VW-1										
31014	14 (41x30) [2.08 (41x.25)]	.030	.76	.144	3.66	2500 [†]	762.2	50.0	22.7	8
						5000 ^{††}	1524.0	105.0	47.7	8
31012	12 (65x30) [3.29 (65x.25)]	.030	.76	.167	4.24	3000 ^{††}	914.4	93.0	42.3	8
31010	10 (65x28) [5.23 (65x.32)]	.030	.76	.184	4.67	2500 [†]	762.2	105.0	47.7	8
31008	8 (133x29) [8.60 (133x.29)]	.045	1.14	.268	6.75	2500 [†]	762.2	190.0	86.4	8
UL Type SIS										
31014N	14 (41x30) [2.08 (41x.25)]	.030	.76	.144	3.66	2500 [†]	762.2	52.5	23.9	8
31012N	12 (65x30) [3.29 (65x.25)]	.030	.76	.167	4.24	2500 [†]	762.2	77.5	35.2	8
31010N	10 (65x28) [5.23 (65x.32)]	.030	.76	.184	4.67	2500 [†]	762.2	107.5	48.9	8
31008N	8 (133x29) [8.60 (133x.29)]	.045	1.14	.268	6.75	2500 [†]	762.2	192.5	87.3	8

[†]Spools may contain more than one piece. Length may vary ±10% from length shown.

^{††}May contain more than one piece. Minimum length of any one piece is 200 ft.

Hypalon®

UL AWM Style 3191 600V, 105°C (CSA Type CL1053)

Product Description

This insulation is chlorosulfonated polyethylene. Hypalon insulation has excellent heat resistance, color stability and electrical properties. Hypalon is recommended for motor leads for Class 130(B) insulation systems. It may be considered as an alternative to Silicone rubber to withstand 155°C varnish baking temperatures, but is not suitable for operating temperatures above Class 130(B).

Recommended maximum baking cycles:
24 hours @ 300°F (149°C)



Stranded tinned copper conductor

UL AWM Style 3191, 3192, 3193 600V, 105°C (CSA Type CL1052, 300V)

Product Description

This insulation is chlorosulfonated polyethylene. Hypalon insulation has excellent heat resistance, color stability and electrical properties. Hypalon is recommended for motor leads for Class 130(B) insulation systems. It may be considered as an alternative to Silicone rubber to withstand 155°C varnish baking temperatures, but is not suitable for operating temperatures above Class 130(B).

Recommended maximum baking cycles:
24 hours @ 300°F (149°C)

Stranded Conductor



Stranded tinned copper conductor

Separator Over Conductor



Separator

Hypalon is a DuPont trademark.

Part No.	AWG (stranding) [sq. mm] (stranding in mm)	Insulation Thickness		Nominal OD		Standard Lengths		Standard Unit Weight		Stock Colors (See Color Codes Chart on Page 3.29)
		Inch	mm	Inch	mm	Ft.	m	Lbs.	kg	

600V, 105°C (UL & CSA)

UL AWM Style 3191 • CSA Type CL1053										
34418	18 (16x30) [.81 (16x.25)]	.045	1.14	.142	3.61	100 [†]	30.5	2.3	1.0	2, 10
						500 ^{††}	152.4	8.0	3.6	2, 4, 5, 8-10, 13
						5000 [▼]	1524.0	75.0	34.1	2, 5, 8, 10
34416	16 (26x30) [1.32 (26x.25)]	.045	1.14	.155	3.94	100 [†]	30.5	2.8	1.3	2, 10
						500 ^{††}	152.4	10.5	4.8	2, 4, 5, 8-10, 13
						4000 [▼]	1219.2	84.0	38.1	8, 10
34414	14 (41x30) [2.08 (41x.25)]	.045	1.14	.170	4.32	100 [†]	30.5	3.7	1.7	2, 8, 10
						500 ^{††}	152.4	14.0	6.4	2, 5, 8, 10
						4000 [▼]	1219.2	108.0	49.1	8, 10
34412	12 (65x30) [3.29 (65x.25)]	.045	1.14	.190	4.83	100 [†]	30.5	4.6	2.1	2, 8, 10
						500 ^{††}	152.4	17.5	7.9	2, 5, 8, 10, 13
						3000 [▼]	914.4	114.0	51.8	10

[†]100 ft. put-ups are one piece, exact. ^{††}250 ft. and 500 ft. put-ups are exact, may contain 2 pieces max. Min. length 50 ft.
*May contain more than one piece. Minimum length of any one piece is 200 ft.

600V, 105°C (UL) • 300V, 105°C (CSA)

UL AWM Style 3191 • CSA Type CL1052**										
34410	10 (65x28) [5.23 (65x.32)]	.045	1.14	.209	5.31	100 [†]	30.5	6.0	2.7	8, 10
						500 ^{††}	152.4	24.5	11.2	8, 10
						2000 [▼]	609.6	102.0	46.3	8, 10
UL AWM Style 3192 • CSA Type CL1052**										
34408*	8 (84x27) [8.60 (84x.36)]	.060	1.52	.290	7.37	100 [†]	30.5	9.4	4.3	8, 10
						250 ^{††}	76.2	24.8	11.2	8, 10
						1000 [▲]	304.8	136.0	61.8	10
34406*	6 (84x25) [13.66 (84x.46)]	.060	1.52	.343	8.71	100 [†]	30.5	13.7	6.2	8, 10
						250 ^{††}	76.2	32.3	14.7	10
						1000 [▲]	304.8	136.0	61.8	10
34404*	4 (105x24) [21.53 (105x.51)]	.060	1.52	.399	10.14	100 [†]	30.5	19.1	8.7	8, 10
						250 ^{††}	76.2	51.0	23.2	10
						500 ^{††}	152.4	97.0	44.1	10
34403*	3 (133x24) [27.28 (133x.51)]	.060	1.52	.420	10.69	500 ^{††}	152.4	118.0	53.6	10
						100 [†]	30.5	30.3	13.8	8, 10
						250 ^{††}	76.2	70.8	32.2	10
34402*	2 (163x24) [33.43 (163x.51)]	.060	1.52	.454	11.53	500 ^{††}	152.4	139.0	63.2	10
						100 [†]	30.5	30.3	13.8	8, 10
						250 ^{††}	76.2	70.8	32.2	10
UL AWM Style 3193 • CSA Type CL1052**										
34401*	1 (210x24) [43.07 (210x.51)]	.080	2.03	.557	14.15	50 [†]	15.2	18.4	8.4	10
						100 [†]	30.5	43.0	19.5	8, 10
						250 ^{††}	76.2	97.0	44.1	10
34490*	1/0 (262x24) [53.73 (262x.51)]	.080	2.03	.607	15.42	50 [†]	15.2	22.5	10.3	8, 10
						100 [†]	30.5	48.9	22.2	10
						250 ^{††}	76.2	114.8	52.2	10
34400*	2/0 (504x26) [67.85 (504x.41)]	.080	2.03	.668	16.97	50 [†]	15.2	27.6	12.6	8
						100 [†]	30.5	57.9	26.3	10
						250 ^{††}	76.2	139.5	63.4	10
34430*	3/0 (630x26) [84.81 (630x.41)]	.080	2.03	.732	18.59	50 [†]	15.2	38.5	17.5	10
						250 ^{††}	76.2	175.8	79.9	10
34440*	4/0 (805x26) [108.37 (805x.41)]	.080	2.03	.819	20.80	50 [†]	15.2	47.5	21.5	8, 10
						250 ^{††}	76.2	215.0	97.7	10

*Separator over conductor. **CSA requires additional wall thickness in sizes 10 AWG and larger to meet CL1053 requirements.

[†]50 and 100 ft. put-ups are one piece, exact. ^{††}250 and 500 ft. put-ups are exact, may contain 2 pieces max. Min. length 50 ft.

[▲]1000 ft. put-ups exact, may contain 3 pieces max. Minimum length of any one piece is 50 ft.

[▼]May contain more than one piece. Minimum length of any one piece is 200 ft.



Hypalon®

UL AWM Style 3190 300V, 105°C (CSA Type CL1052)

Product Description

This insulation is chlorosulfonated polyethylene. Hypalon insulation has excellent heat resistance, color stability and electrical properties. Hypalon is recommended for motor leads for Class 130(B) insulation systems. It may be considered as an alternative to Silicone rubber to withstand 155°C varnish baking temperatures, but is not suitable for operating temperatures above Class 130(B).

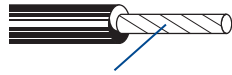

Stranded tinned copper conductor

5000V High-Voltage Hypalon

Product Description

This insulation is chlorosulfonated polyethylene. Hypalon insulation has excellent heat resistance, color stability and electrical properties.



Separator
Stranded tinned copper conductor

Part No.	AWG (stranding) [sq. mm] (stranding in mm)	Insulation Thickness		Nominal OD		Standard Lengths		Standard Unit Weight		Stock Colors (See Color Codes Chart on Page 3.29)
		Inch	mm	Inch	mm	Ft.	m	Lbs.	kg	

300V, 105°C (UL & CSA)

UL AWM Style 3190 • CSA Type CL1052										
34922	22 (7x30) [.36 (7x.25)]	.030	.76	.093	2.36	5000 ^{††}	1524.0	35.0	15.9	10
34920	20 (10x30) [.51 (10x.25)]	.030	.76	.100	2.54	5000 ^{††}	1524.0	45.0	20.5	8, 10
34918	18 (16x30) [.81 (16x.25)]	.030	.76	.110	2.79	500 [†]	152.4	6.0	2.7	2, 4, 10
						5000 ^{††}	1524.0	55.0	25.0	2, 10
34916	16 (26x30) [1.32 (26x.25)]	.030	.76	.123	3.12	500 [†]	152.4	8.0	3.6	2, 9, 10
						5000 ^{††}	1524.0	80.0	36.4	10
34914	14 (41x30) [2.08 (41x.25)]	.030	.76	.138	3.51	*	*	*	*	Special Order*

*Contact Belden's Customer Service Department for order requirements. 1-800-BELDEN-1.

[†]May contain more than one piece. Minimum length of any one piece is 50 ft.

^{††}May contain more than one piece. Minimum length of any one piece is 200 ft.

5000V

High-Voltage										
36108	8 (84x27) [8.60 (84x.36)]	.150	3.81	.480	12.19	50 [▲]	15.2	7.9	3.6	10
						500 [◆]	152.4	86.5	39.3	10
36106	6 (84x25) [13.66 (84x.46)]	.150	3.81	.532	13.51	50 [▲]	15.2	10.5	4.8	10
						500 [◆]	152.4	113.5	51.6	10
36104	4 (105x24) [21.53 (105x.51)]	.150	3.81	.588	14.94	50 [▲]	15.2	13.9	6.3	10
						500 [◆]	152.4	148.0	67.3	10
36102	2 (163x24) [33.43 (163x.51)]	.150	3.81	.643	16.33	50 [▲]	15.2	22.4	10.2	10
						500 [◆]	152.4	194.0	88.2	10
36101	1 (210x24) [43.07 (210x.51)]	.150	3.81	.700	17.78	50 [▲]	15.2	26.4	12.0	10
						250 [◆]	76.2	121.8	55.3	10
36190	1/0 (262x24) [53.73 (262x.51)]	.150	3.81	.750	19.05	50 [▲]	15.2	32.4	14.7	10
						500 [◆]	152.4	287.5	130.7	10
36100	2/0 (504x26) [67.85 (504x.41)]	.150	3.81	.815	20.70	50 [▲]	15.2	37.5	17.0	10
						250 [◆]	76.2	247.5	112.5	10
36140	4/0 (805x26) [108.37 (805x.41)]	.150	3.81	.959	24.36	50 [▲]	15.2	52.5	23.8	10
						250 [◆]	76.2	247.5	112.5	10

[▲]50 ft. put-ups are one piece, exact.

[◆]250 ft. and 500 ft. put-ups are exact, but may contain 2 pieces max. Minimum length of any one piece is 50 ft.

Hypalon is a DuPont trademark.



For more information, contact Belden Technical Support: 1-800-BELDEN-1 • www.belden.com

Neoprene

UL AWM Style 3044 300V, 90°C (CSA Type CL902)

Product Description

Neoprene insulation has good heat aging characteristics and is an excellent low-cost motor lead wire. It may be considered for use in hazardous locations and is being used in explosion-proof motors recognized by UL. 12 AWG and smaller sizes are dual labeled UL and CSA.

Recommended maximum baking cycles:
24 hours @ 300°F (149°C) • 8 hours @ 325°F (163°C)
15 minutes @ 450°F (232°C)



Stranded tinned copper conductor

UL AWM Style 3046, 3048, 3049 600V, 90°C (CSA Type CL903 available as shown)

Product Description

Neoprene insulation has good heat aging characteristics and is an excellent low-cost motor lead wire. It may be considered for use in hazardous locations and is being used in explosion-proof motors recognized by UL. 12 AWG and smaller sizes are dual labeled UL and CSA.

Recommended maximum baking cycles:
24 hours @ 300°F (149°C) • 8 hours @ 325°F (163°C)
15 minutes @ 450°F (232°C)

Stranded Conductor



Stranded tinned copper conductor

Separator Over Conductor



Separator

Part No.	AWG (stranding) [sq. mm] (stranding in mm)	Insulation Thickness		Nominal OD		Standard Lengths		Standard Unit Weight		Stock Colors (See Color Codes Chart on Page 3.29)
		Inch	mm	Inch	mm	Ft.	m	Lbs.	kg	

300V, 90°C (UL & CSA)

UL AWM Style 3044 • CSA Type CL902										
31520	20 (10x30) [.51 (10x.25)]	.030	.76	.100	2.54	500 [†]	152.4	5.0	2.3	10
						5000 ^{††}	1524.0	40.0	18.2	10
31518	18 (16x30) [.81 (16x.25)]	.030	.76	.109	2.77	500 [†]	152.4	6.0	2.7	2, 4, 5, 6, 9, 10
						2000 ^{††}	609.6	22.0	10.0	1-3, 5, 6, 9, 10
						5000 ^{††}	1524.0	55.0	25.0	1-6, 9, 10, B02
31516	16 (26x30) [1.32 (26x.25)]	.030	.76	.122	3.10	500 [†]	152.4	8.0	3.6	2-6, 9, 10
						5000 ^{††}	1524.0	75.0	34.1	2, 4, 5, 9, 10

[†]May contain more than one piece. Minimum length of any one piece is 50 ft.
^{††}May contain more than one piece. Minimum length of any one piece is 200 ft.

600V, 90°C (UL)

UL AWM Style 3046 • CSA Type CL903										
32518	18 (16x30) [.81 (16x.25)]	.045	1.14	.142	3.61	500 [†]	152.4	8.5	3.9	9, 10
						5000 ^{††}	1524.0	80.0	36.4	9, 10
32516	16 (26x30) [1.32 (26x.25)]	.045	1.14	.155	3.94	500 [†]	152.4	11.0	5.0	2-6, 9, 10
						5000 ^{††}	1524.0	105.0	47.7	10
31514	14 (41x30) [2.08 (41x.25)]	.045	1.14	.169	4.29	500 [†]	152.4	13.5	6.1	2, 4, 5, 9, 10
						4000 ^{††}	1219.2	108.0	49.1	2, 4, 5, 9, 10
31512	12 (65x30) [3.29 (65x.25)]	.045	1.14	.190	4.83	250 [†]	76.2	10.0	4.5	10
						3000 ^{††}	914.4	117.0	53.2	10
UL AWM Style 3046**										
31510	10 (65x28) [5.29 (65x.32)]	.045	1.14	.209	5.31	250 [†]	76.2	13.0	5.9	10
						2000 ^{††}	609.6	106.0	48.2	10
UL AWM Style 3048**										
31508*	8 (84x27) [8.60 (84x.36)]	.060	1.52	.285	7.24	500 [†]	152.4	47.5	21.6	2, 10
31506*	6 (84x25) [13.66 (84x.46)]	.060	1.52	.343	8.71	500 [†]	152.4	66.5	30.2	10
31504*	4 (105x24) [21.53 (105x.51)]	.060	1.52	.399	10.14	250 [†]	76.2	52.0	23.6	10
31502*	2 (163x24) [33.43 (163x.51)]	.060	1.52	.454	11.53	250 [†]	76.2	69.3	31.4	10
UL AWM Style 3049**										
31501*	1 (210x24) [43.07 (210x.51)]	.080	2.03	.557	14.15	250 [†]	76.2	98.5	44.8	10
31590*	1/0 (262x24) [53.73 (262x.51)]	.080	2.03	.607	15.42	250 [†]	76.2	116.8	53.1	10
31500*	2/0 (504x26) [67.85 (504x.41)]	.080	2.03	.668	16.97	250 [†]	76.2	141.5	64.3	10

*Separator over conductor.
**CSA requires additional wall thickness in sizes 10 AWG and larger to meet CL903 requirements.
[†]May contain more than one piece. Minimum length of any one piece is 50 ft.
^{††}May contain more than one piece. Minimum length of any one piece is 200 ft.

Silicone Rubber Braidless

UL AWM Style 3212, 3213, 3214 600V, 150°C (CSA Type AWM)

Product Description

The 333 series of braidless Silicone 150°C lead wire features easy and clean stripping without the problems associated with glass braid wire. It has excellent physical and mechanical strength properties. Braidless Silicone lead wire is also recommended for consideration in applications requiring Class 155(F) or Class 180(H) materials. Recommended for high-temperature applications in motors, lighting fixtures, clothes dryers, stoves, therapeutic and electronic devices. It is recommended that varnish compatibility be checked before production. Some rigid varnishes may cause cracking when the wire is severely bent.

Recommended maximum baking cycles:
24 hours @ 410°F (210°C)

Stranded Conductor

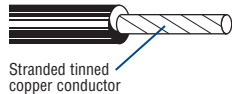

Separator Over Conductor

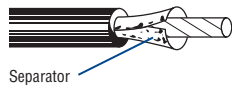

UL AWM Style 3135 600V, 200°C

Product Description

The 334 Series is for use only in totally enclosed systems.

Recommended maximum baking cycles:
24 hours @ 410°F (210°C)

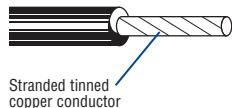

Part No.	AWG (stranding) [sq. mm] (stranding in mm)	Insulation Thickness		Nominal OD		Standard Lengths		Standard Unit Weight		Stock Colors (See Color Codes Chart on Page 3.29)
		Inch	mm	Inch	mm	Ft.	m	Lbs.	kg	

600V, 150°C (UL & CSA)

UL AWM Style 3212 • CSA Type AWM

33322	22 (7x30) [.36 (7x.25)]	.045	1.14	.125	3.18	*	*	*	*	Special Order*
33320	20 (10x30) [.51 (10x.25)]	.045	1.14	.132	3.53	*	*	*	*	Special Order*
33318	18 (16x30) [.81 (16x.25)]	.045	1.14	.142	3.61	500 [†]	152.4	7.0	3.2	9, 10
33316	16 (26x30) [1.32 (26x.25)]	.045	1.14	.155	3.94	500 [†]	152.4	9.5	4.3	9, 10
33314	14 (41x30) [2.08 (41x.25)]	.045	1.14	.170	4.32	500 [†]	152.4	12.0	5.5	9, 10
33312	12 (65x30) [3.29 (65x.25)]	.045	1.14	.190	4.83	500 [†]	152.4	16.5	7.5	9, 10
33310[†]	10 (65x28) [5.23 (65x.32)]	.045	1.14	.209	5.31	500 [†]	152.4	22.5	10.3	10

UL AWM Style 3213 • CSA Type AWM

33308[†]	8 (84x27) [8.60 (84x.36)]	.060	1.52	.283	7.19	500	152.4	38.5	17.6	10
33306[†]	6 (84x25) [13.66 (84x.46)]	.060	1.52	.334	8.48	500 [†]	152.4	61.5	28.0	10
33304[†]	4 (105x24) [21.53 (105x.51)]	.060	1.52	.390	9.91	250 [*]	76.2	48.8	22.2	10
33302[†]	2 (163x24) [33.43 (163x.51)]	.060	1.52	.457	11.61	250 [*]	76.2	67.0	30.4	10

UL AWM Style 3214 • CSA Type AWM

33390[†]	1/0 (262x24) [53.73 (262x.51)]	.080	2.03	.594	15.09	250 [*]	76.2	108.3	49.2	10
--------------------------	-----------------------------------	------	------	------	-------	------------------	------	-------	------	----

^{*}Contact Belden's Customer Service Department for order requirements. **1-800-BELDEN-1.**
[†]Separator over conductor.

^{*}250 ft. put-ups are exact, but may contain 2 pieces max. Minimum length of any one piece is 50 ft.
[†]May contain more than one piece. Length may vary ±10% from length shown.

600V, 200°C (UL)

UL AWM Style 3135

33418	18 (7x26) [.94 (7x.41)]	.030	.76	.111	2.82	*	*	*	*	Special Order*
33416	16 (7x24) [1.44 (7x.51)]	.030	.76	.123	3.12	*	*	*	*	Special Order*
33414	14 (7x22) [2.27 (7x.64)]	.030	.76	.139	3.53	*	*	*	*	Special Order*

^{*}Contact Belden's Customer Service Department for order requirements. **1-800-BELDEN-1.**

Silicone Rubber Glass Braid

UL AWM Style 3071, 3074, 3075, 3125 and 3126
600V, 200°C
 (CSA Type SEW-2)

VW-1

Product Description

UL recognizes finer strands on the 150°C rated wire. The Silicone insulation strips clean and easy. The glass braid provides additional abrasion resistance and is treated to prevent fraying. Recommended for high-temperature applications in motors, lighting fixtures, clothes dryers, stoves, therapeutic and electronic devices. These wires can be used with Class 130(B), 155(F) or 180(H) insulation systems.

Recommended maximum baking cycles:
 24 hours @ 410°F (210°C)

Stranded Conductor

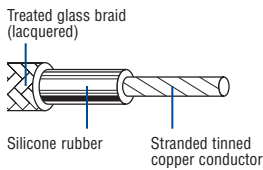

Separator Over Conductor

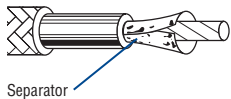

Part No.	AWG (stranding) [sq. mm] (stranding in mm)	Insulation Thickness		Nominal OD		Standard Lengths		Standard Unit Weight		Stock Colors (See Color Codes Chart on Page 3.29)
		Inch	mm	Inch	mm	Ft.	m	Lbs.	kg	

600V, 200°C (UL & CSA)

UL AWM Style 3071 • CSA Type SEW-2

32418	18 (7x26) [.94 (7x.41)]	.030	.76	.133	3.38	500 [†]	152.4	6.5	3.4	9, 10
						6000 ^{††}	1829.3	78.0	35.5	9, 10

32416	16 (7x24) [1.44 (7x.51)]	.030	.76	.145	3.68	500 [†]	152.4	9.5	4.3	9, 10
						6000 ^{††}	1829.3	108.0	49.1	10

32414	14 (7x22) [2.27 (7x.64)]	.030	.76	.167	4.24	500 [†]	152.4	12.0	5.5	9, 10
						4000 ^{††}	1219.2	100.0	45.5	9, 10

UL AWM Style 3074 • CSA Type SEW-2

32412	12 (19x24.5) [3.30 (19x.47)]	.030	.76	.190	4.83	500 [†]	152.4	17.5	8.0	9, 10
-------	---------------------------------	------	-----	------	------	------------------	-------	------	-----	-------

UL AWM Style 3075 • CSA Type SEW-2

32410	10 (19x22.5) [5.27 (19x.59)]	.045	1.14	.238	6.05	500 [†]	152.4	26.5	12.1	9, 10
-------	---------------------------------	------	------	------	------	------------------	-------	------	------	-------

UL AWM Style 3125 • CSA Type SEW-2

30808*	8 (54x25) [8.78 (54x.46)]	.060	1.52	.313	7.95	100 [▲]	30.5	9.8	4.5	9, 10
						500 [†]	152.4	48.0	21.8	9, 10
						3000 [†]	914.4	285.0	129.5	9, 10

30806* [†]	6 (84x25) [13.66 (84x.46)]	.060	1.52	.368	9.35	100 [▲]	30.5	14.2	6.5	9, 10
						500 [†]	152.4	69.5	31.5	9, 10
						2000 [†]	609.6	284.0	129.1	9, 10

30804*	4 (105x24) [21.53 (105x.51)]	.060	1.52	.424	10.77	250 [•]	76.2	50.5	22.9	9, 10
--------	---------------------------------	------	------	------	-------	------------------	------	------	------	-------

30802*	2 (163x24) [33.43 (163x.51)]	.060	1.52	.496	12.60	250 [•]	76.2	72.8	33.0	9, 10
--------	---------------------------------	------	------	------	-------	------------------	------	------	------	-------

UL AWM Style 3126 • CSA Type SEW-2

30801*	1 (210x24) [43.07 (210x.51)]	.080	2.03	.622	15.80	100 [▲]	30.5	43.2	19.6	9, 10
						250 [•]	76.2	100.5	45.7	9, 10

30890*	1/0 (262x24) [53.73 (262x.51)]	.080	2.03	.670	17.02	100 [▲]	30.5	51.5	23.4	9, 10
						250 [•]	76.2	123.5	56.1	9, 10

30800*	2/0 (504x26) [67.85 (504x.41)]	.080	2.03	.727	18.47	50 [▲]	15.2	31.1	14.1	9
						100 [▲]	30.5	60.5	27.5	9
						250 [•]	76.2	146.0	66.4	9

30830*	3/0 (630x26) [84.81 (630x.41)]	.080	2.03	.795	20.19	250 [•]	76.2	181.3	82.7	9
--------	-----------------------------------	------	------	------	-------	------------------	------	-------	------	---

30840*	4/0 (266x21) [109.51 (266x.72)]	.080	2.03	.779	19.79	50 [▲]	15.2	47.9	21.8	9
						250 [•]	76.2	221.0	100.8	9

*Separator over conductor.

[†]May contain more than one piece. Length may vary ±10% from length shown.

^{††}May contain more than one piece. Minimum length of any one piece is 200 ft.

[▲]50 ft. and 100 ft. put-ups are one piece, exact.

[•]250 ft. put-ups are exact, but may contain 2 pieces max. Minimum length of any one piece is 50 ft.

Silicone Rubber

Glass Braid and Mercury Switch Wire

Glass Braid

UL AWM Style 3069, 3070, 3101

600V, 150°C

(CSA Type SEWF-2)

VW-1

Product Description

UL recognizes finer strands on the 150°C rated wire. The Silicone insulation strips clean and easy. The glass braid provides additional abrasion resistance and is treated to prevent fraying. Recommended for high-temperature applications in motors, lighting fixtures, clothes dryers, stoves, therapeutic and electronic devices. These wires can be used with Class 130(B), 155(F) or 180(H) insulation systems.

Recommended maximum baking cycles:
24 hours @ 410°F (210°C)

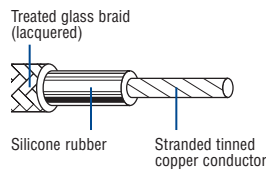

Mercury Switch

UL AWM Style 3123

600V, 150°C

Product Description

Suitable for mercury switches when protected against mechanical abuse. This wire has a tough, flexible Silicone insulation that remains flexible over a wide temperature range: +150°C to -55°C.

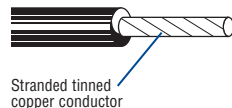

Part No.	AWG (stranding) [sq. mm] (stranding in mm)	Insulation Thickness		Nominal OD		Standard Lengths		Standard Unit Weight		Stock Colors (See Color Codes Chart on Page 3.29)
		Inch	mm	Inch	mm	Ft.	m	Lbs.	kg	

600V, 150°C (UL & CSA)

UL AWM Style 3069 • CSA Type SEWF-2

30820	20 (10x30) [.51 (10x.25)]	.030	.76	.122	3.10	500 [†]	152.4	5.0	2.3	9, 10
--------------	------------------------------	------	-----	------	------	------------------	-------	-----	-----	-------

UL AWM Style 3070 • CSA Type SEWF-2

30818	18 (16x30) [.81 (16x.25)]	.030	.76	.132	3.35	100 [*]	30.5	2.0	.9	9, 10
						500 [†]	152.4	6.5	2.9	9, 10

30816	16 (26x30) [1.32 (26x.25)]	.030	.76	.145	3.68	500 [†]	152.4	9.0	4.1	9, 10
--------------	-------------------------------	------	-----	------	------	------------------	-------	-----	-----	-------

30814	14 (41x30) [2.08 (41x.25)]	.030	.76	.164	4.17	500 [†]	152.4	12.0	5.5	9, 10
--------------	-------------------------------	------	-----	------	------	------------------	-------	------	-----	-------

30812	12 (65x30) [3.29 (65x.25)]	.030	.76	.186	4.72	500 [†]	152.4	17.0	7.7	9, 10
--------------	-------------------------------	------	-----	------	------	------------------	-------	------	-----	-------

UL AWM Style 3101 • CSA Type SEWF-2

30810	10 (65x28) [5.23 (65x.32)]	.045	1.14	.239	6.07	100 [*]	30.5	5.8	2.6	9, 10
						500 [†]	152.4	25.0	11.4	9, 10

*100 ft. put-ups are one piece, exact.

†May contain more than one piece. Length may vary ±10% from length shown.

600V, 150°C (UL)

UL AWM Style 3123

34020	20 (105x40) [.52 (105x.08)]	.030	.76	.110	2.79	2000 ^{††}	609.6	16.0	7.3	8
--------------	--------------------------------	------	-----	------	------	--------------------	-------	------	-----	---

34017	17 (210x40) [1.03 (210x.08)]	.030	.76	.118	3.00	2000 ^{††}	609.6	24.0	10.9	8
--------------	---------------------------------	------	-----	------	------	--------------------	-------	------	------	---

††May contain more than one piece. Minimum length of any one piece is 200 ft.

High-Voltage Leads

22 AWG Stranded Conductor (7x30)

Product Description

Tinned copper, conductive polyethylene (Korona-Guard) over inner conductor provides uniform distribution of voltage stresses, polyethylene insulation. PVC jacket in Red (8868) or Black (8869).

Suggested Working Voltage: 24,000 DC (8868)
17,000 DC (8869)

Breakdown Voltage: 48,000 DC (8868)
35,000 DC (8869)

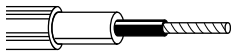

Part No.	Insulation Thickness		Jacket Thickness		Nominal OD		Standard Lengths		Standard Unit Weight		Stock Colors (See Color Codes Chart on Page 3.29)
	Inch	mm	Inch	mm	Inch	mm	Ft.	m	Lbs.	kg	

22 AWG Stranded Conductor (7x30)

80°C											
8868	.044	1.12	.015	.38	.150	3.81	100	30.5	1.9	.9	2
							U-500	U-152.4	6.0	2.7	2
							500	152.4	6.0	2.7	2
8869	.027	.69	.015	.38	.120	3.05	100	30.5	1.6	.7	10
							500	152.4	4.5	2.0	10

20 AWG Stranded Conductor (7x28)

UL AWM Style 3239 (80°C)

VW-1

Product Description

Tinned copper, conductive polyethylene (Korona-Guard) over inner conductor provides uniform distribution of voltage stresses, polyethylene insulation. Red PVC jacket.

Suggested Working Voltage: 30,000 DC

Breakdown Voltage: 60,000 DC

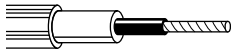

20 AWG Stranded Conductor (7x28)

UL AWM Style 3239 • 80°C											
9867	.046	1.17	.028	.71	.191	4.85	100	30.5	3.0	1.4	2
							500	152.4	10.5	4.8	2

18 AWG Stranded Conductor (16x30)

Product Description

Tinned copper, conductive polyethylene (Korona-Guard) over inner conductor provides uniform distribution of voltage stresses, polyethylene insulation. Red PVC jacket.

Suggested Working Voltage: 40,000 DC

Breakdown Voltage: 80,000 DC

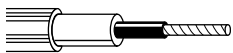

18 AWG Stranded Conductor (16x30)

80°C											
8866	.057	1.45	.015	.38	.208	5.28	100	30.5	3.0	1.4	2
							U-500	U-152.4	11.5	5.2	2
							500	152.4	10.0	4.6	2

Test Prod Wire

18 AWG Rubber Insulation 5000V, 90°C

Product Description

Tinned copper, rubber insulation.

Suggested Working Voltage: 5000V

Breakdown Voltage: 20,000V



18 AWG PVC Insulation UL AWM Style 1855 (5000V, 80°C)

Product Description

Tinned copper, PVC insulation. Use test probe leads for electrical and electronic measuring for test equipment.

Suggested Working Voltage: 5000V



18 AWG Rubber Insulation 5000V, 80°C

Product Description

Tinned copper, separator, rubber insulation. Manufactured for MIL-W-13169B.

Suggested Working Voltage: 5000V

Breakdown Voltage: 20,000V



Part No.	AWG (stranding)	Insulation Thickness		Nominal OD		Standard Lengths		Standard Unit Weight		Stock Colors (See Color Codes Chart on Page 3.29)
		Inch	mm	Inch	mm	Ft.	m	Lbs.	kg	

18 AWG Rubber Insulation

5000V, 90°C

8899	18 (65x36)	.045	1.14	.144	3.66	10	3.0	.2	.1	2, 10
						14	4.3	.5	.2	2&10*
						25	7.6	.6	.3	2, 4, 5, 6, 8, 9, 10
						100	30.5	2.3	1.0	2, 4, 5, 6, 8, 9, 10
						U-500	U-152.4	8.5	3.9	2, 10
						500	152.4	8.5	3.9	2, 4, 5, 6, 8, 9, 10
U-1000	U-304.8	16.0	7.3	2, 10						
1000	304.8	15.0	6.8	2, 10						

*Includes both Red & Black cable in one put-up.

18 AWG PVC Insulation (UL)

UL AWM Style 1855 • 5000V, 80°C

9899	18 (65x36)	.048	1.22	.144	3.66	100	30.5	2.2	1.0	2, 10
						500	152.4	7.5	3.4	2, 5, 9, 10
						1000	304.8	13.0	5.9	2, 10

18 AWG Rubber Insulation

5000V, 80°C

8897	18 (65x36)	.045	1.14	.144	3.66	U-500	U-152.4	8.5	3.9	2, 10
						500	152.4	8.5	3.9	2, 10

Test Prod Wire and Gas Tube Sign and Ignition Cable

18 AWG Rubber Insulation 10,000V, 90°C

Product Description

Tinned copper, rubber insulation.

Suggested Working Voltage: 10,000V

Breakdown Voltage: 29,000V



24 AWG Rubber Insulation 1000V, 90°C • Miniature

Product Description

Tinned copper, separator, rubber insulation.

Suggested Working Voltage: 1000V

Breakdown Voltage: 10,000V



Gas Tube Sign and Ignition UL GTO-10 — 10kV, 105°C (CSA Type GTO-10 — 10kV)

Product Description

GTO cables are single conductors for use with gas-tube systems for signs, outline lighting or interior lights and for use with oil-burning equipment in accordance with the National Electrical Code. GTO-10 lead wire has an 18 AWG stranded tinned copper conductor and is insulated with a chemically cross-linked ethylene-propylene diene elastomer. Unshielded, it is available with either a flat black (color code 10) or dark gray (color code 876) exterior.



Stranded tinned copper conductor

Part No.	AWG (stranding)	Insulation Thickness		Nominal OD		Standard Lengths		Standard Unit Weight		Stock Colors (See Color Codes Chart on Page 3.29)
		Inch	mm	Inch	mm	Ft.	m	Lbs.	kg	

18 AWG Rubber Insulation

10,000V, 90°C										
8898	18 (65x36)	.088	2.24	.229	5.82	25	7.6	1.7	.8	2, 10
						100	30.5	3.9	1.8	2, 10
						500	152.4	16.0	7.3	2, 10

24 AWG Rubber Insulation

1000V, 90°C • Miniature										
8890	24 (45x40)	.019	.48	.066	1.68	25	7.6	.1	.05	2, 10
						100	30.5	.4	.20	2, 10
						500	152.4	2.5	1.10	2, 10

Part No.	AWG (stranding) [sq. mm] (stranding in mm)	Insulation Thickness		Nominal OD		Standard Lengths		Standard Unit Weight		Stock Colors (See Color Codes Chart on Page 3.29)
		Inch	mm	Inch	mm	Ft.	m	Lbs.	kg	

10kV, 105°C (UL) • 10kV (CSA)

UL and CSA Type GTO-10										
39018	18 (19x30) [.96 (19x.25)]	.100	2.54	.247	6.27	500 [†]	152.4	16.5	7.5	10, 876
						1000 ^{††}	304.8	37.0	16.8	10, 876
						1500 ^{††}	457.3	54.0	24.5	10

[†]May contain more than one piece. Minimum length of any one piece is 50 ft.

^{††}May contain more than one piece. Minimum length of any one piece is 200 ft.

Magnet Wire

Class 200 One Pound Spool

Product Description

Belden® high-temperature Class 200 Magnet Wire is dual coated. Its base coat is a cross-linked, modified polyester. Its top coat is an amide-imide polymer. Rated for 200°C usage, Belden Class 200 Magnet Wire has exceptional ability to resist solvents and abuse in difficult windings.



Single Beldsol Solderable Half Pound Spool

Product Description

Beldsol Magnet Wire is a dual insulated Magnet Wire that combines the excellent dielectric characteristics of polyurethane and the known toughness and solvent resistance of a nylon overcoat. This wire is rated by IEEE tests for 270°F usage and will solder without insulation removal at 750°F.



Part No.	AWG	Approximate Length		Standard Unit Weight		Turns per Linear Inch	Turns per Square Inch
		Ft.	m	Lbs.	kg		

Class 200

J-W-1177/14 • MW 35-C (Heavy) or MW 74-C (Heavy)							
8073	14	80	24.4	1.1	.5	14.9	222
8074	16	126	38.4	1.1	.5	18.6	346
8075	18	199	60.7	1.1	.5	23.2	538
8076	20	315	96.0	1.1	.5	28.9	835
8077	22	501	152.7	1.1	.5	36.0	1296
8078	24	793	241.7	1.1	.5	44.7	1998
8079	26	1260	384.1	1.1	.5	55.7	3102
8080	28	1990	606.6	1.1	.5	69.4	4816
8081	30	3140	957.1	1.1	.5	86.2	7430
8083	34	7860	2395.8	1.1	.5	133.1	17716
8085*	38	19300	5882.7	1.1	.5	206.0	42436

*8085 is a single coat of modified polyester insulation and made to NEMA MW 74-C (Heavy).

Single Beldsol Solderable

J-W-1177/9 • MW 28-C (Single)							
8049	18	100	30.5	.5	.2	23.9	571
8050	20	160	48.8	.5	.2	29.9	894
8051	22	254	77.4	.5	.2	37.5	1406
8052	24	404	123.1	.5	.2	46.9	2200
8053	26	645	196.6	.5	.2	59.0	3481
8054	28	1020	310.9	.5	.2	73.8	5446
8055	30	1615	492.3	.5	.2	91.7	8409
8056	32	2515	766.6	.5	.2	114.0	12996
8057	34	4060	1237.5	.5	.2	144.0	20736
8058	36	6400	1950.7	.5	.2	180.0	32400

Shielding and Bonding Cable and Direct Burial Cable

Roadway Loop Cables

Braided Wire

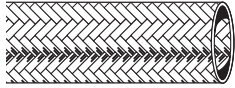

Part No.	Approx. AWG (stranding)	Standard Lengths		Standard Unit Weight		Recommended Current (Amps)	Approximate Circular Area		Nominal ID Tubular		
		Ft.	m	Lbs.	kg		CMA	mm ²	Inch	mm	
Braided Wire											
8660	14.3 (96x34) tinned	50	15.2	.7	.3	27.0	3800	1.92	.125	3.18	
		250	76.2	3.8	1.7						
8668	13.3 (120x34) tinned	50	15.2	1.1	.5	36.0	4800	2.43	.172	4.37	
		250	76.2	5.0	2.3						
8663	11.9 (168x34) tinned	50	15.2	2.1	.9	38.0	6700	3.40	.219	5.56	
		250	76.2	6.8	3.1						
8661	11.3 (192x34) tinned	50	15.2	2.2	1.0	46.0	7600	3.85	.203	5.16	
		250 *	76.2	7.3	3.3						
8669	8.9 (336x34) tinned	50	15.2	3.4	1.5	62.0	13300	6.74	.500	12.70	
		250 *	76.2	11.5	5.2						
8662	6.6 (576x34) tinned	50	15.2	4.7	2.1	80.0	22900	11.60	.781	19.84	
		250 *	76.2	20.0	9.1						
8670	3.4 (480x30) tinned	10	3.0	1.9	.9	145.0	48000	24.32	.750	19.05 (Flat Width)	
		50	15.2	9.0	4.1						
		250 *	76.2	41.3	18.8						

Note: Dimensions shown are approximate, due to pliable nature of braided cables.
*May contain more than one piece. Minimum length of any one piece is 25 ft.

Direct Burial

14 AWG Stranded Conductor (104x34)

Product Description

Tinned copper conductor. Black high-density polyethylene insulation.

Suggested Working Voltage: 600V

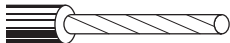

Part No.	Insulation Thickness		Jacket Thickness		Nominal OD		Standard Lengths		Standard Unit Weight		Stock Colors
	Inch	mm	Inch	mm	Inch	mm	Ft.	m	Lbs.	kg	
14 AWG Stranded Conductor (104x34)											
80°C											
9438	.032	.81	—	—	.139	3.53	1000	304.8	18.0	8.2	Black

Bus Bar, Antenna and Aluminum Ground Wire

Bus Bar Wire

Product Description

Made in accordance with the performance requirements of Federal Spec. QQ-W-343G. Solid tinned copper. Belden® can certify upon special request compliance to the performance requirements of QQ-W-343S_S1T.



Part No.	AWG	Standard Lengths		Standard Unit Weight		Nominal OD		Circular Area	
		Ft.	m	Lbs.	kg	Inch	mm	CMA	mm ²
Bus Bar Wire									
8025	30	100	30.5	.1	.05	.010	.26	102	.05
		1000	304.8	1.0	.50				
8024	28	100	30.5	.1	.05	.013	.33	164	.08
		1000	304.8	1.0	.50				
8023	26	100	30.5	.1	.05	.016	.41	262	.13
		1000	304.8	1.0	.50				
8022	24	100	30.5	.2	.10	.021	.52	424	.22
		1000	304.8	1.0	.50				
8021	22	100	30.5	.2	.10	.026	.65	650	.33
		1000	304.8	2.0	.90				
8020	20	100	30.5	.4	.20	.033	.83	1056	.54
		1000	304.8	3.0	1.40				
8019	18	100	30.5	.5	.20	.041	1.03	1648	.84
		1000	304.8	6.0	2.70				
8013	16	100	30.5	.8	.40	.052	1.31	2673	1.35
		1000	304.8	9.0	4.10				
8012	14	100	30.5	1.5	.70	.065	1.66	4251	2.15
		1000	304.8	14.0	6.40				
8011	12	100	30.5	2.3	1.00	.083	2.11	6872	3.48

Antenna Wire

Product Description

Stranded bare copper-covered steel.



Part No.	AWG	Standard Package Lengths		Standard Unit Weight		Nominal OD	
		Ft.	m	Lbs.	kg	Inch	mm
Antenna Wire							
8002	16 (7x24)	100	30.5	.8	.4	.060	1.52
		1000	304.8	13.0	5.9		
8000	14 (7x22)	100	30.5	1.3	.6	.076	1.93
		1000	304.8	13.0	5.9		

Aluminum Ground Wire

Product Description

8 AWG solid, soft annealed aluminum. Packaged in ten 50-foot connected coils or spools of 500 feet. Spools are marked every 100 feet for easy measuring.



Aluminum Ground Wire							
8018	8 (solid)	50	15.2	.9	.4	.128	3.25
		500	152.4	8.5	3.9		

Technical Information

Conductor and Insulation Materials

The technical information provided in this section has been expanded to include additional graphs and supplementary data as an aid in specifying the hook-up and lead wire best suited to the needs of a particular application. If you require additional technical information, contact Belden Technical Support at **1-800-BELDEN-1**.

The tables on the following pages are offered as a guide to assist users in selecting the correct lead wire for their application.

Conductors

Uni-Strand®

Uni-Strand tinned copper conductor. In this type of construction, the bare copper wires are stranded, then tinned to coat the strands and also to fill in the interstices between strands. This allows for easier wire stripping with no re-twisting operation.

Insulation Materials

PVC

Vinyl plastic insulation is fast stripping, resists oil, solvents, and ozone. The colors are bright and remain distinct after processing. Applications include motors, transformers, fluorescent ballasts and fixtures, switchboards, panels, controls, rectifiers and electronic circuits. Meets VW-1 Vertical Wire Flame Test in many cases.

Teflon®

Teflon is a fluorinated thermoplastic with outstanding thermal, physical, and electrical properties. Teflon is generally restricted to applications requiring its special characteristics because its basic resin and processing costs are relatively high.

Belden Teflon wire products are highly recommended for miniature cable applications because of their superior thermal and electrical properties. Teflon is especially suitable for internal wiring-soldering applications where insulation melt back is a specific problem. Belden wiring products insulated with Teflon are outstanding in their resistance to oil, oxidation, heat, sunlight and flame; and also in their ability to remain flexible at low temperatures. They have excellent resistance to ozone, water, alcohol, gasoline, acids, alkalis, aromatic hydrocarbons and solvents.

EPDM

EPDM (ethylene-propylene diene elastomer) is a chemically cross-linked elastomer with excellent flexibility at high and low temperatures (+150°C to -60°C). It has good insulation and dielectric strength, as well as excellent abrasion resistance and mechanical properties. EPDM also has better cut-through resistance than Silicone rubber, which it replaces in some applications.

EPDM is compatible with most varnishes. After the dip and bake cycle, however, the varnish tends to adhere to the insulation because EPDM, unlike some rubber insulations, does not exude oils or waxes. As the lead wires are pulled apart for termination or flexed, the varnish cracks, sometimes tearing the insulation.

To help this problem, a stearic solution is applied to the lead wire during the manufacturing process. However, many varnishes may still bond to the insulation unless other special coatings are applied. (Other slip coats are available at additional cost.) **Because most cleaning processes will remove these coatings from the EPDM lead wire, cleaning EPDM lead wire before using in the process is not recommended.**

Due to the above, it is recommended that the compatibility between the individual lead wire size, the bake/varnish process and varnish used always be checked; and if possible, do not allow any varnish to extend beyond a point where the lead wire will be flexed or bent.

XL-Dur®

XL-Dur is a lead wire insulation utilizing thermoset, chemically cross-linked polyethylene. Because of its excellent physical and electrical properties, XL-Dur is highly desirable for a wide variety of applications.

Hypalon®

This insulation is chlorosulfonated polyethylene. Hypalon insulation has excellent heat resistance, color stability and electrical properties.

Neoprene

Neoprene insulation has good heat aging characteristics and is an excellent low-cost motor lead wire. It may be considered for use in hazardous locations and is being used in explosion-proof motors recognized by UL.

Silicone Rubber

Braidless Silicone lead wire features easy and clean stripping without the problems associated with glass braid lead wire. It has excellent physical and mechanical strength properties.

Recommended for high-temperature applications in motors, lighting fixtures, clothes dryers, stoves, therapeutic, and electronic devices. It is recommended that varnish compatibility be checked before production. Some rigid varnishes may cause cracking when the wire is severely bent.

Silicone Rubber — Glass Braid

The Silicone insulation strips clean and easy. The glass braid provides additional abrasion resistance and is treated to prevent fraying.

Recommended for high-temperature applications in motors, lighting fixtures, clothes dryers, stoves, therapeutic and electronic devices.

Hypalon and Teflon are DuPont trademarks.

Technical Information

Insulation Characteristics and Color Codes

Table 1: Insulation Characteristics

Insulation	Temperature Rating	UL Voltage Rating (Volts)	Oil Resistance	Ozone Resistance	Abrasion	Flame Resistance
Neoprene	90°C	300/600	Good	Good	Good	Good
PVC	80°C	300	Good-Excellent	Good-Excellent	Good	Excellent
	105°C	600	Good-Excellent	Good-Excellent	Good	Excellent
Hypalon®	105°C	300/600	Good	Excellent	Good	Good
XL-Dur®	105°C	300	Good	Good	Excellent	Fair-Good
Cross-Linked Polyethylene	125°C	600	Good	Good	Excellent	Fair-Good
	150°C	600	Good	Good	Excellent	Fair-Good
EPDM	125°C	600	Fair-Poor	Good	Good	Fair
	150°C	600	Fair-Poor	Good	Good	Fair
Silicone Rubber	150°C	300	Fair	Good	Poor	Good
	200°C	600	Fair	Good	Poor	Good
Silicone Rubber Glass Braid	150°C	600	Fair	Excellent	Excellent	Good
	200°C	600	Fair	Excellent	Excellent	Good
Teflon®	150°C	300	Excellent	Excellent	Excellent	Excellent
	200°C	300	Excellent	Excellent	Excellent	Excellent
	260°C	300	Excellent	Excellent	Excellent	Excellent

Table 2: Lead Wire Color Code Chart

Color No.	Color Combination	Color No.	Color Combination	Color No.	Color Combination
1	Brown	13	Dark Blue	25	White/Black/Yellow
2	Red	14	White/Black	26	White/Black/Blue
3	Orange	15	White/Red	27	White/Black/Brown
4	Yellow	16	White/Green	28	White/Black/Orange
5	Green	17	White/Yellow	29	White/Black/Gray
6	Light Blue	18	White/Blue	30	White/Black/Purple
7	Purple	19	White/Brown	189	Green/Yellow
8	Gray	20	White/Orange	620	Green/min. 30% Yellow
9	White	21	White/Gray	876	Nickel Gray
10	Black	22	White/Purple	B02	Purple
11	Tan	23	White/Black/Red		
12	Pink	24	White/Black/Green		

Non-Stock Colors: Non-stock colors and stripes of catalog items are available in minimum quantities. Price and delivery information is available upon request. Orders must be in multiples of standard packages.

Hypalon and Teflon are DuPont trademarks.



Technical Information

Current Carrying Capacity

Table 3: Lead Wire Current Carrying Capacity

AWG	90°C Neoprene, SIS	105°C Vinyl, Hypalon®	125°C XL-Dur,® Hermetic	150°C EPDM, XL-Dur, Silicone	200°C Silicone
22	10	11	12	14	16
20	13	14	15	18	21
18	18	20	22	24	28
16	24	26	28	31	35
14	35	39	42	46	54
12	40	51	55	60	68
10	55	67	72	80	90
8	80	90	97	106	124
6	105	121	131	155	165
4	140	160	172	109	220
3	165	180	194	214	252
2	190	215	232	255	293
1	220	247	266	293	344
1/0	260	286	309	339	399
2/0	300	329	355	390	467
3/0	350	380	410	451	546
4/0	405	446	481	529	629

Values (amperes) shown in this table are maximum for a single conductor in free air with an assumed ambient room temperature of 30°C (86°F).

Table 4: Current Carrying Capacity of 2 or 3 Conductors

AWG	90°C Neoprene, SIS	105°C Vinyl, Hypalon	125°C XL-Dur, Hermetic	150°C EPDM, XL-Dur, Silicone	200°C Silicone
22	6	7	8	9	10
20	8	9	10	13	15
18	14	15	16	17	20
16	18	19	20	22	25
14	25	29	31	34	36
12	30	36	39	43	45
10	40	46	50	55	60
8	55	64	69	76	83
6	75	81	87	96	110
4	95	109	118	120	125
3	110	129	139	143	152
2	130	143	154	160	171
1	150	168	181	186	197
1/0	170	193	208	215	229
2/0	195	229	247	251	260
3/0	225	263	284	288	297
4/0	260	301	325	332	346

Current carrying capacity of not more than three (3) conductors in a raceway, conduit or cable. The values (amperes) shown in this table are maximum at an assumed ambient room temperature of 30°C (86°F).

Hypalon is a trademark of DuPont.

How to Use

The choice of an appropriate conductor, with respect to current carrying capacity, usually depends on one or more factors which vary according to application. These factors include the temperature in which the lead wire operates, temperature rise of equipment, limitations of insulation, voltage drop, and location of wires as in free air or enclosed, such as formed by a compartment, tubing, or a bundle of wires.

For these reasons it is not practical to provide a general chart showing the current carrying capacity of Lead Wire for all conditions. Accordingly, the values shown in Table 3 are MAXIMUM for a single conductor in free air, based on ambient temperature of 30°C. For actual use temperatures above an ambient temperature of 30°C, reduce the maximum ampacity by use of correction factor in Table 5 to correct the values in Table 3 and Table 4.

Table 5: Correction Factors for Tables 3 & 4

Ambient Temperature (°C)	Insulation Temperature Rating				
	90°C	105°C	125°C	150°C	200°C
31 – 35	.96	1.00	1.00	1.00	1.00
36 – 40	.91	1.00	1.00	1.00	1.00
41 – 45	.87	.93	.94	.95	.97
46 – 50	.82	.93	.94	.95	.97
51 – 55	.76	.85	.87	.90	.94
56 – 60	.71	.85	.87	.90	.94
61 – 70	.58	.76	.80	.85	.90
71 – 80	.41	.65	.73	.80	.87
81 – 90	—	.53	.64	.74	.83
91 – 100	—	.38	.54	.67	.79
101 – 120	—	—	.24	.52	.71
121 – 140	—	—	—	.30	.61
141 – 160	—	—	—	—	.50
161 – 180	—	—	—	—	.35

For ambient temperatures over 30°C, multiply the ampacities shown in Table 3 or Table 4 by the appropriate correction factor to determine the maximum allowable load current.

Correction Factors for Table 4

Number of Conductors	Reduction Percentage
4 thru 6	80%
7 thru 9	70%
10 thru 20	50%
21 thru 30	45%
31 thru 40	40%
41 and above	35%

If more than three (3) conductors are in a raceway, conduit or cable, the values given in Table 4 must be reduced using the above percentages.

(Example: The ampacity for 7 through 9 conductors = 70% of the value(s) shown in Table 4.)



Technical Information

Temperature Ranges and Classifications

Conductor Configurations

Table 6: Nominal Temperature Operating Ranges (°C)

-100°	-80°	-60°	-40°	-20°	0	20°	40°	60°	80°	100°	120°	140°	160°	180°	200°	220°	240°	
				-30°	Neoprene				90°C									
				-30°	Hypalon®				105°C									
			-60°	EPDM				150°C										
			-75°	Silicone Braidless				200°C										
			-75°	Silicone Braided				200°C										
				-55°	Cross-Linked Polyethylene				150°C									
				-35°	PVC				105°C									
-100°	Teflon®																260°C	

Table 7: Temperature Classification

Insulation System Class	Minimum Acceptable Lead Wire Temperature Rating	
	C°	F°
130(B)	90	194
155(F)	125	257
180(H)	150	302
220(R)	200	392

Systems of Insulating Materials — UL Standard 1446

This is a guide intended for UL approved insulation systems connected to branch circuits of 600V or less. Approval required by Underwriters Laboratories when using lead wire with a temperature rating more than 5°C under the system temperature rating.

Table 8: Conductor Configurations

Typical Application	American Wire Gage							
	12	14	16	18	20	22	24	26
Fixed Services	19x25	solid	solid	solid	solid	solid	solid	solid
Hook-Up Wire		or	or	or	or	or	or	or
Cable in Raceway		19x27	19x29	7x26	7x28	7x30	7x32	7x34
				or	or			
				16x30	10x30			
Moderate Flexing	65x30	19x27	19x29	16x30	7x28,	7x30	7x34	7x34
Frequently Disturbed		or	or	or	10x30,	or	or	
For Maintenance		41x30	26x30	41x34	19x32,	19x34	10x34	
					or			
					26x34			
Severe Flexing	165x34	104x34	65x34	41x34	26x34	19x34	19x36	7x34
Microphone			or	or	or	or	or	or
Test Prods			104x36	65x36	42x36	26x36	45x40	10x36
Most Severe Duty	259x36	168x36	105x36	63x36	105x40			
Mercury Switches	(7x37	(7x24	(7x15	(7x9	(3x35	(Consider Braid or Tinsel)		
	Rope Lay)*	Rope Lay)*	Rope Lay)*	Rope Lay)*	Rope Lay)*			

Note: For a given AWG wire size (based on equal cross-sectional area of conductor), limpness and flex life are increased by use of a large number of fine strands. The finer stranding does result in higher costs.

*Rope Lay is several stranded groups cabled together. For example: #12 AWG, 259x36 is 7 cords each consisting of 37 strands of #36 AWG

Hypalon and Teflon are DuPont trademarks.



Technical Information

Packaging

Drums

Conductor is available in three drum pack sizes:

- The #15 Beldpak® is 15" high and 23" in diameter.
- The #31 Beldpak is 30½" high and 23" in diameter.
- The #42 Beldpak (pictured) is 42" high and 23" in diameter.



Price and delivery information is available upon request.

OD of Wire		#15 Beldpak		#31 Beldpak		#42 Beldpak	
Inch	mm	1000'	km	1000'	km	1000'	km
.070	1.78	35	10.7	70	21.3	85	25.9
.080	2.03	27	8.2	55	16.8	70	21.3
.090	2.29	21	6.4	43	13.1	55	16.8
.100	2.54	17	5.2	35	10.7	48	14.6
.110	2.79	12	3.7	25	7.6	40	12.2
.120	3.05	10	3.0	20	6.1	34	10.4
.130	3.30	9	2.7	18	5.5	30	9.1
.140	3.56	8	2.4	15	4.6	20	6.1
.150	3.81	7	2.1	14	4.3	18	5.5
.160	4.06	6	1.8	12	3.7	16	4.9
.170	4.32	5	1.5	10	3.0	14	4.3

Reels

Reel dimensions will vary by size, determined by AWG of wire.



OD of Wire		Quantity		Crate Reels*	Head Diameter		Barrel Diameter		Height Transverse	
Inch	mm	1000'	km		Inch	mm	Inch	mm	Inch	mm
.080	2.03	10.0	3.05	1748	15¾	400	8	203	8	203
.090	2.29	8.0	2.44	1748	15¾	400	8	203	8	203
.100	2.54	6.5	1.98	1748	15¾	400	8	203	8	203
.110	2.79	5.0	1.52	1748	15¾	400	8	203	8	203
.120	3.05	6.0	1.83	1747	15¾	400	8	203	10½	267
.130	3.30	5.0	1.52	1747	15¾	400	8	203	10½	267
.140	3.56	6.0	1.83	1746	17¾	451	8	203	10½	267
.150	3.81	5.0	1.52	1746	17¾	451	8	203	10½	267
.160	4.06	4.5	1.37	1746	17¾	451	8	203	10½	267
.170	4.32	7.0	2.13	1744	22	559	10	254	14¼	362
.180	4.57	6.0	1.83	1744	22	559	10	254	14¼	362
.190	4.83	5.5	1.68	1744	22	559	10	254	14¼	362
.200	5.08	5.0	1.52	1744	22	559	10	254	14¼	362
.250	6.35	5.0	1.52	1743	26	660	10	254	14¼	362
.300	7.62	3.5	1.07	1743	26	660	10	254	14¼	362
.350	8.89	2.5	.76	1743	26	660	10	254	14¼	362
.400	10.16	2.0	.61	1743	26	660	10	254	14¼	362
.450	11.43	1.5	.46	1743	26	660	10	254	14¼	362
.500	12.70	1.2	.37	1743	26	660	10	254	14¼	362
.550	13.97	1.0	.31	1743	26	660	10	254	14¼	362
.600	15.24	1.2	.37	1733	30	762	10	254	14¼	362

*Crate Reel numbers are Belden's internal numbers. They are representative only to the extent of the dimensions shown. Weight of the wire may require another reel with dimensions identical to those shown.

Special Orders

Orders for special packages must be placed for footage mentioned or for multiples for these quantities per color.



4 Multi-Conductor Cables

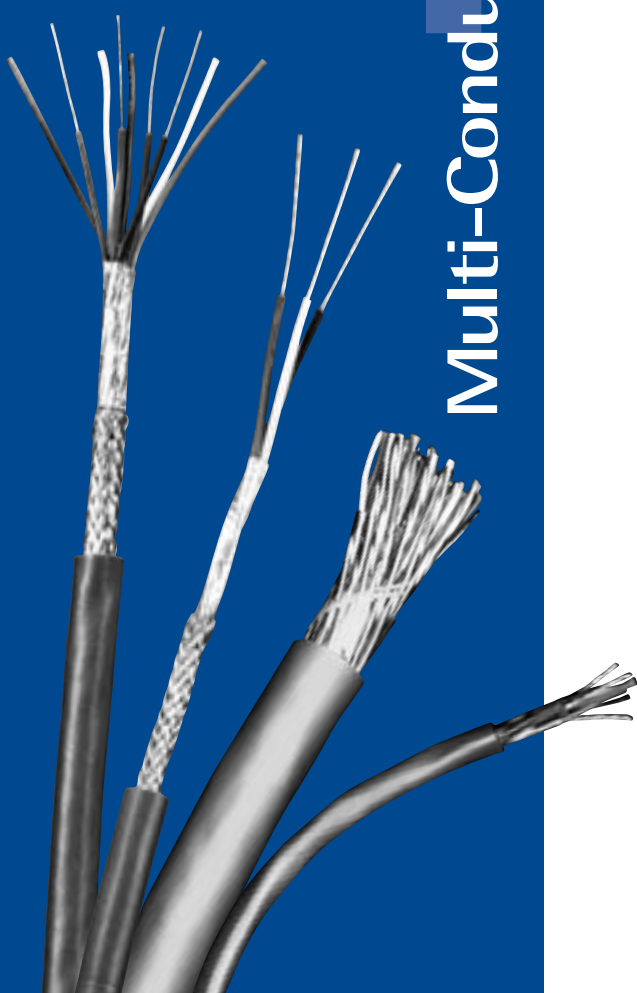

Table of Contents

Multi-Conductor Cables	Page No.
Introduction	4.2
Selection Guide:	
Shielded Computer Cables for RS-232 Applications	4.2
Unshielded	4.3-4.9
Audio, Control and Instrumentation Cables	4.3
22 AWG Non-Plenum & Plenum	4.3
20 AWG Non-Plenum	4.5
18 AWG Non-Plenum & Plenum	4.5
16 AWG Non-Plenum	4.6
14 AWG Non-Plenum	4.7
22 and 18 AWG Non-Plenum	4.7
20 and 16 AWG Non-Plenum	4.7
Antenna Rotor Control Cables	4.8
Duplex Primary Wires	4.8
Power and Control Cables	4.9
Overall Beldfoil® Shield	4.10-4.13
Computer Cables for Synchronous EIA Interface	4.10
Computer Cables for EIA RS-232 Applications	4.11
Audio, Control and Instrumentation Cables	4.12
22 AWG Non-Plenum	4.12
20 AWG Non-Plenum	4.12
18 AWG Non-Plenum & Plenum	4.13
16 AWG Non-Plenum	4.13
Overall Braid and Special Shielding	4.14
Audio, Control and Instrumentation Cables	4.14
Overall Braid Shield	4.15
MIL-Spec Communication & Instrumentation Cables	4.15
Overall Foil/Braid Shield	4.16-4.19
Computer Cables for EIA RS-232 Applications	4.16
28 AWG Non-Plenum	4.16
28 AWG Non-Plenum, Low Capacitance	4.16
26 and 24 AWG Non-Plenum, IEEE 488	4.16
24 AWG Non-Plenum	4.17
22 AWG Non-Plenum	4.19
Overall Shield	4.20-4.22
Special Audio, Control and Instrumentation Cables	4.20
Data Cables for Molex SEMMCONN and AMP® SDL Connectors	4.21
Direct Burial Cables	4.22
Plenum-Rated Cable	4.23-4.27
Unshielded	4.23
Overall Beldfoil Shield	4.24
Overall Foil/Braid Shield	4.25
High-Temperature Control & Instrumentation Cable	4.28-4.31
Unshielded	4.28
Overall Beldfoil Shield	4.29
Overall Braid Shield: MIL-W-16878/4 (Type E)	4.30
Fire Alarm Cable	4.32-4.34

Introduction

Belden® multi-conductor cables are manufactured in a wide variety of gage sizes, dimensions, insulation materials, shielding configurations, and jacketing materials including Plenum and High-Temperature versions. These cables meet the technical requirements of many different types of systems. In fact, Belden offers one of the broadest lines of UL Listed, NEC and CEC multi-conductor cables available from any single source.

Applications for multi-conductor cables include computers, communications, instrumentation, sound, control, audio, and data transmission. Each of these cables is designed to protect signal integrity under critical conditions by reducing hum, noise, and crosstalk.

To assist you in selecting the proper cable for your application, both the suggested working voltages and the maximum temperature ratings are indicated for each applicable product in this section.

Most of our multi-conductor cables are available from stock. Many of these are available off the shelf from distributors. If you have a new or unusual application or you cannot find a multi-conductor cable in this catalog section that meets your technical requirements, contact Technical Support at 1-800-BELDEN-1.

Multi-Conductor Cables Packaging

Belden's unique UnReel® cable dispenser is available for many of the multi-conductor products listed in this section. The letter "U" before the specified put-up length denotes UnReel packaging.

Selection Guide

Shielded Multi-Conductor Computer Cables for RS-232 Applications

Specifications		Cable Series*			
		9925	9608	9533	9939
Conductor Size: (AWG)	28				
	24	✓	✓	✓	
	22				✓
	20				
	18				
Page No.		4.18	4.17	4.11	4.19
Insulation:	S-R PVC		✓	✓	✓
	Polyethylene				
	Polypropylene				
	Datalene®†	✓			
Shield:	Overall Foil			✓	
	Drain Wire	✓		✓	
	Overall Foil/Braid	✓	✓		✓
	Braid Coverage	65%	65%		65%
Drain Wire Overall:		Yes	No	Yes	No
No. of Cond. Available:	1				
	2				
	3	✓	✓	✓	✓
	4	✓	✓	✓	✓
	5	✓	✓	✓	✓
	6	✓	✓	✓	✓
	7	✓	✓	✓	✓
	8	✓	✓	✓	✓
	9	✓	✓	✓	✓
	10	✓	✓	✓	✓
	11				
	12				
	13				
	15	✓	✓	✓	✓
	17				
	18				
	19				
	20			✓	
	25	✓	✓	✓	✓
	27				
30			✓		
31					
37	✓	✓		✓	
40			✓		
50		✓	✓	✓	
Capacitance ** (pF/ft.)		12.0	30.0	30.0	35.0

*All cables are UL-listed.

**Capacitance may vary on some cables.





† Foam high density polyethylene.

Unshielded









Audio, Control and Instrumentation Cables Non-Plenum

Description	Part No.	UL NEC/ C(UL) CEC Type	No. of Cond.	Color Code	Standard Lengths		Standard Unit Weight		Insulation Thickness		Jacket Thickness		Nominal OD	
					Ft.	m	Lbs.	kg	Inch	mm	Inch	mm	Inch	mm

22 AWG Solid Bare Copper Conductors • Conductors Cabled

Polyethylene Insulation • Rose Gray PVC Jacket														
	8795 UL AWM Style 2092 (300V 60°C)	NEC: CM CEC: CM	2	Red, Green	U-500	U-152.4	10.0	4.5	.018	.46	.022	.56	.168	4.27
					U-1000	U-304.8	19.0	8.6						
					1000	304.8	17.0	7.8						
	8794 UL AWM Style 2093 (300V 60°C)	NEC: CM	3	Green, Red, Yellow	U-1000	U-304.8	22.0	10.0	.018	.46	.022	.56	.178	4.52
					1000	304.8	21.0	9.6						
	9794 UL AWM Style 2094 (300V 60°C)	NEC: MP, CM	4	Green, Red, Yellow, Black	U-500	U-152.4	14.0	6.4	.018	.46	.025	.64	.200	5.08
					U-1000	U-304.8	26.0	11.8						
					1000	304.8	25.0	11.4						
	1242A UL AWM Style 2094 (300V 60°C)	NEC: CM CEC: CM	4	Green, Red, Yellow, Black	U-1000	U-304.8	16.0	7.2	.018	.46	.025	.64	.154	3.91

22 AWG Stranded (7x30) Tinned Copper Conductors • Conductors Cabled

PVC Insulation • Chrome PVC Jacket														
	8442* UL AWM Style 2576 (150V 80°C)	NEC: CMG CEC: CMG FT4	2	Black, Red	100	30.5	2.4	1.1	.015	.38	.025	.64	.170	4.32
					U-500	U-152.4	8.0	3.7						
					500	152.4	7.5	3.4						
					U-1000	U-304.8	15.0	6.8						
					1000	304.8	15.0	6.8						
*Twisted pair					10000 [†]	3048.0	150.0	68.2						
	8443	NEC: CMG CEC: CMG FT4	3	Black, Red, Green	100	30.5	2.7	1.2	.010	.25	.032	.81	.172	4.37
					U-500	U-152.4	9.5	4.3						
					500	152.4	9.5	4.3						
					U-1000	U-304.8	18.0	8.2						
					1000	304.8	18.0	8.2						
	8444	NEC: CMG CEC: CMG FT4	4	See Chart 1 (Tech Info Section)	100	30.5	3.1	1.4	.010	.25	.032	.81	.185	4.70
					U-500	U-152.4	11.5	5.2						
					500	152.4	11.5	5.2						
					U-1000	U-304.8	22.0	10.0						
					1000	304.8	23.0	10.5						
	8445	NEC: CMG CEC: CMG FT4	5	See Chart 1 (Tech Info Section)	100	30.5	3.5	1.6	.010	.25	.032	.81	.194	4.93
					U-500	U-152.4	13.5	6.1						
					500	152.4	13.5	6.1						
					U-1000	U-304.8	25.0	11.4						
					1000	304.8	26.0	11.8						
	9430	NEC: CMG CEC: CMG FT4	7	See Chart 1 (Tech Info Section)	U-500	U-152.4	17.0	7.7	.010	.25	.032	.81	.214	5.44
					500	152.4	17.0	7.7						
					U-1000	U-304.8	32.0	14.5						
					1000	304.8	34.0	15.9						
	9421	NEC: CMG CEC: CMG FT4	8	See Chart 1 (Tech Info Section)	U-500	U-152.4	4.2	1.9	.010	.25	.032	.81	.229	5.82
					500	152.4	19.0	8.7						
					500	152.4	18.5	8.4						
					U-1000	U-304.8	36.0	16.3						
					1000	304.8	38.0	17.2						
	9423	NEC: CMG CEC: CMG FT4	9	See Chart 1 (Tech Info Section)	100	30.5	4.7	2.1	.010	.25	.032	.81	.244	6.20
					U-500	U-152.4	21.0	9.6						
					500	152.4	21.5	9.8						
					U-1000	U-304.8	41.0	18.6						
					1000	304.8	43.0	19.5						
	8456	NEC: CMG CEC: CMG FT4	10	See Chart 1 (Tech Info Section)	100	30.5	5.0	2.3	.010	.25	.032	.81	.264	6.71
					U-500	U-152.4	22.5	10.2						
					500	152.4	23.0	10.5						
					U-1000	U-304.8	44.0	20.0						
					1000	304.8	46.0	20.9						

[†]Final put-up may vary -10% to +20%. May contain two pieces, minimum length of any one piece is 1500 ft.





Unshielded

Audio, Control and Instrumentation Cables Plenum-Rated and Non-Plenum



Description	Part No.	UL NEC/ C(UL) CEC Type	No. of Cond.	Color Code	Standard Lengths		Standard Unit Weight		Insulation Thickness		Jacket Thickness		Nominal OD	
					Ft.	m	Lbs.	kg	Inch	mm	Inch	mm	Inch	mm

22 AWG Stranded (7x30) Tinned Copper Conductors • Conductors Cabled *(continued)*

PVC Insulation • Chrome PVC Jacket															
 UL AWM Style 2576 (150V 80°C)	8457	NEC:	12	See	100	30.5	5.6	2.5	.010	.25	.032	.81	.272	6.91	
		CMG		Chart 1	U-500	U-152.4	25.5	11.6							
		CEC:		(Tech Info	500	152.4	26.0	11.8							
		CMG FT4		Section)	U-1000	U-304.8	50.0	22.7							
					1000	304.8	52.0	23.6							
	8458	NEC:	15	See	100	30.5	7.3	3.3	.010	.25	.040	1.02	.315	8.00	
		CMG		Chart 2R	500	152.4	35.5	16.1							
		CEC:		(Tech Info	1000	304.8	72.0	32.7							
		CMG FT4		Section)											
	9431	NEC:	20	See	100	30.5	9.1	4.1	.010	.25	.040	1.02	.345	8.76	
		CMG		Chart 2R	500	152.4	48.5	22.0							
		CEC:		(Tech Info	1000	304.8	87.0	39.5							
		CMG FT4		Section)											
	8459	NEC:	25	See	100	30.5	11.1	5.0	.010	.25	.040	1.02	.387	9.83	
		CMG		Chart 2R	500	152.4	55.0	25.0							
		CEC:		(Tech Info	1000	304.8	109.0	49.5							
		CMG FT4		Section)											
	9432	NEC:	30	See	100	30.5	12.5	5.7	.010	.25	.040	1.02	.400	10.16	
		CMG		Chart 2R	500	152.4	62.5	28.4							
		CEC:		(Tech Info	1000	304.8	124.0	56.3							
		CMG FT4		Section)											
	9433	NEC:	40	See	100	30.5	16.6	7.5	.010	.25	.040	1.02	.455	11.56	
		CMG		Chart 2R	500	152.4	83.0	37.7							
		CEC:		(Tech Info	1000	304.8	161.0	73.1							
		CMG FT4		Section)											
	9434	NEC:	50	See	500	152.4	100.5	45.7	.010	.25	.045	1.14	.500	12.70	
		CMG		Chart 2R	1000	304.8	206.0	93.5							
		CEC:		(Tech Info											
		CMG FT4		Section)											

Plenum • FEP Insulation • Red FEP Jacket														
 300V RMS, Non-conduit	88442*	NEC:	2	Black,	100	30.5	2.3	1.0	.006	.15	.012	.30	.102	2.59
		CMP		Red	500 [†]	152.4	5.5	2.5						
		CEC:			1000 [†]	304.8	8.0	3.7						
		CMG FT6												
 300V RMS, Non-conduit	88444	NEC:	4	Black,	100	30.5	2.9	1.3	.006	.15	.010	.25	.121	3.07
		CMP		White,	500 [†]	152.4	9.0	4.1						
		CEC:		Red,	1000 [†]	304.8	15.0	6.8						
		CMG FT6		Green										

Suitable for Outdoor and Direct Burial applications.

Plenum • FEP Insulation • Natural Flamarrest® Jacket														
 300V RMS, Non-conduit	82442*	NEC:	2	Black,	U-1000 [†]	U-304.8	9.0	4.1	.006	.15	.015	.38	.113	2.87
		CMP		Red	1000 [†]	304.8	8.0	3.7						
		CEC:												
		CMG FT6												
 300V RMS, Non-conduit	82444	NEC:	4	Black,	U-500 [†]	U-152.4	9.0	4.1	.006	.15	.015	.38	.134	3.40
		CMP		White,	U-1000 [†]	U-304.8	16.0	7.3						
		CEC:		Red,	1000 [†]	304.8	15.0	6.8						
		CMG FT6		Green										

* Twisted Pair

[†]Spools and/or UnReel® cartons are one piece, but length may vary ±10% for spools and ±5% for UnReel from length shown.

Unshielded

Audio, Control and Instrumentation Cables Non-Plenum

Description	Part No.	UL NEC/ C(UL) CEC Type	No. of Cond.	Color Code	Standard Lengths		Standard Unit Weight		Insulation Thickness		Jacket Thickness		Nominal OD	
					Ft.	m	Lbs.	kg	Inch	mm	Inch	mm	Inch	mm

20 AWG Stranded (7x28) Tinned Copper Conductors • Conductors Cabled

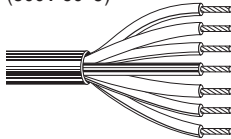
PVC Insulation • Chrome PVC Jacket																		
 <p>UL AWM Style 2464 (300V 80°C)</p>	9444	NEC:	4	See Chart 1 (Tech Info Section)	100	30.5	4.0	1.8	.013	.33	.032	.81	.217	5.51				
		CMG			U-500	U-152.4	16.5	7.5										
		CEC:			500	152.4	16.5	7.5										
		CMG FT4			U-1000	U-304.8	32.0	14.5										
					1000	304.8	33.0	15.0										
	9445	NEC:	5	See Chart 1 (Tech Info Section)	100	30.5	4.4	2.1	.013	.33	.032	.81	.239	6.07				
		CMG			U-500	U-152.4	20.0	9.1										
		CEC:			500	152.4	19.5	8.9										
		CMG FT4			U-1000	U-304.8	38.0	17.2										
					1000	304.8	40.0	18.2										
	9439	NEC:	7	See Chart 1 (Tech Info Section)	100	30.5	5.7	2.6	.013	.33	.032	.81	.260	6.60				
		CMG			U-500	U-152.4	26.0	11.9										
		CEC:			500	152.4	27.0	12.3										
		CMG FT4			U-1000	U-304.8	51.0	23.1										
					1000	304.8	53.0	24.1										
	9455	NEC:	9	See Chart 1 (Tech Info Section)	100	30.5	7.1	3.2	.013	.33	.035	.89	.317	8.05				
		CMG			U-500	152.4	35.0	15.9										
		CEC:			1000	304.8	67.0	30.4										
		CMG FT4																
	9457	NEC:	12	See Chart 1 (Tech Info Section)	100	30.5	9.2	4.2	.013	.33	.035	.89	.338	8.58				
		CMG			U-500	152.4	45.0	20.4										
		CEC:			1000	304.8	88.0	40.0										
		CMG FT4																
	9458	NEC:	15	See Chart 2R (Tech Info Section)	100	30.5	12.6	5.7	.013	.33	.040	1.02	.389	9.88				
		CMG			U-500	152.4	60.5	27.5										
		CEC:			1000	304.8	118.0	53.6										
		CMG FT4																

18 AWG Stranded (19x30) Tinned Copper Conductors • Conductors Cabled

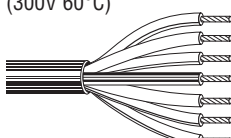
PVC Insulation • Chrome PVC Jacket																		
 <p>UL AWM Style 2598 (300V 60°C)</p>	8489	NEC:	4	See Chart 1 (Tech Info Section)	100	30.5	5.1	2.3	.017	.43	.032	.81	.257	6.53				
		CMG			U-500	U-152.4	23.5	10.7										
		CEC:			500	152.4	24.0	10.9										
		CMG FT4			U-1000	U-304.8	46.0	20.9										
					1000	304.8	48.0	21.8										
	8465	NEC:	5	See Chart 1 (Tech Info Section)	100	30.5	6.4	2.9	.017	.43	.033	.84	.282	7.16				
		CMG			U-500	U-152.4	29.5	13.5										
		CEC:			500	152.4	30.0	13.6										
		CMG FT4			U-1000	U-304.8	58.0	26.3										
					1000	304.8	60.0	27.4										
	8467	NEC:	7	See Chart 1 (Tech Info Section)	100	30.5	8.3	3.8	.017	.43	.037	.94	.314	7.98				
		CMG			U-500	152.4	40.5	18.4										
		CEC:			1000	304.8	79.0	35.9										
		CMG FT4																
	8469	NEC:	9	See Chart 1 (Tech Info Section)	100	30.5	10.5	4.8	.017	.43	.037	.94	.364	9.25				
		CMG			U-500	152.4	26.0	11.8										
		CEC:			500	152.4	51.5	23.4										
		CMG FT4			U-1000	U-304.8	105.0	47.7										
	8466	NEC:	12	See Chart 2R (Tech Info Section)	100	30.5	13.2	6.0	.017	.43	.040	1.02	.412	10.46				
		CMG			U-500	152.4	32.5	14.8										
		CEC:			500	152.4	66.0	30.0										
		CMG FT4			U-1000	U-304.8	131.0	59.5										
	8468	NEC:	15	See Chart 2R (Tech Info Section)	100	30.5	17.9	8.1	.017	.43	.045	1.14	.500	12.70				
		CMG			U-500	152.4	89.5	40.6										
		CEC:			1000	304.8	175.0	79.5										
		CMG FT4																



Unshielded

Audio, Control and Instrumentation Cables Plenum-Rated and Non-Plenum

Description	Part No.	UL NEC/ C(UL) CEC Type	No. of Cond.	Color Code	Standard Lengths		Standard Unit Weight		Insulation Thickness		Jacket Thickness		Nominal OD	
					Ft.	m	Lbs.	kg	Inch	mm	Inch	mm	Inch	mm

18 AWG Stranded (19x30) Tinned Copper Conductors • Conductors Cabled *(continued)*

PVC Insulation • Chrome PVC Jacket

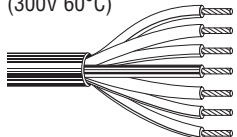
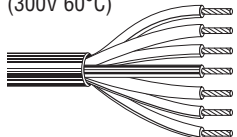
	8619	UL AWM Style 2598 (300V 60°C)	NEC: 19	See	100	30.5	20.3	9.2	.017	.43	.045	1.14	.490	12.45
		CMG	Chart 2R	500	152.4	101.0	45.9							
		CEC: CMG FT4	(Tech Info Section)	1000	304.8	198.0	90.0							
	9626	UL AWM Style 2598 (300V 60°C)	NEC: 25	See	100	30.5	29.1	13.2	.017	.43	.060	1.52	.612	15.54
		CMG	Chart 2R	500	152.4	139.5	63.3							
		CEC: CMG FT4	(Tech Info Section)	1000	304.8	277.0	125.8							

Plenum • FEP Insulation • Red FEP Jacket

	88489	300V RMS	NEC: 4	Black, White, Red, Green	500 [†]	152.4	14.5	6.6	.007	.18	.009	.23	.161	4.09
		CMP		1000 [†]	304.8	29.0	13.2							
		CEC: CMP FT6												

Suitable for Outdoor and Direct Burial applications.

Plenum • FEP Insulation • Natural Flamarrest® Jacket

	82489	300V RMS	NEC: 4	Black, White, Red, Green	U-1000 [†]	U-304.8	31.0	14.1	.007	.18	.014	.36	.170	4.32
		CMP		1000 [†]	304.8	29.0	13.2							
		CEC: CMP FT6												

16 AWG Stranded (19x29) Tinned Copper Conductors • Conductors Cabled

PVC Insulation • Cabled Wire (No Jacket)

	9498	UL AWM Style 1007 (300V 80°C) VW-1	—	3	Orange, Black, Orange w/ Black Stripe	1000	304.8	42.0	19.1	.027	.69	—	—	.243	6.17
--	-------------	--	---	---	--	------	-------	------	------	------	-----	---	---	------	------

PVC Insulation • Chrome PVC Jacket

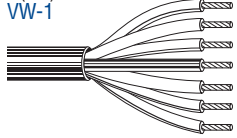
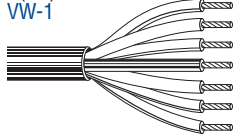
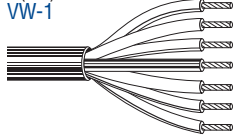
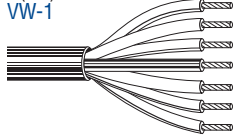
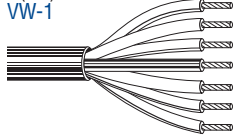
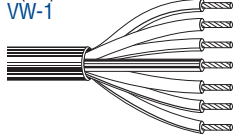
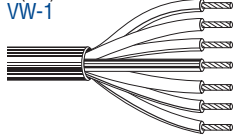
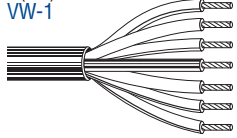
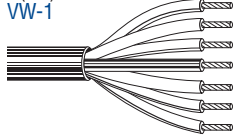
	8620	600V RMS 80°C C(UL) FT4 VW-1	—	4	See Chart 2 (Tech Info Section)	100	30.5	8.9	4.0	.031	.79	.042	1.07	.376	9.55
			500	152.4	44.0	20.0									
			1000	304.8	88.0	40.0									
	9620		—	5	See Chart 2 (Tech Info Section)	100	30.5	11.0	5.0	.031	.79	.042	1.07	.411	10.44
			500	152.4	53.5	24.3									
			1000	304.8	109.0	49.5									
	8621		—	7	See Chart 2R (Tech Info Section)	100	30.5	13.2	6.0	.031	.79	.045	1.14	.458	11.63
			500	152.4	73.5	33.4									
			1000	304.8	143.0	65.0									
	9721		—	8	See Chart 2R (Tech Info Section)	100	30.5	27.3	12.4	.031	.79	.045	1.14	.496	12.60
			500	152.4	136.5	62.0									
			1000	304.8	269.0	122.1									
	9621		—	9	See Chart 2R (Tech Info Section)	100	30.5	17.0	7.8	.031	.79	.045	1.14	.533	13.54
			500	152.4	94.0	42.7									
			1000	304.8	181.0	82.2									
	8622		—	12	See Chart 2R (Tech Info Section)	100	30.5	27.0	12.3	.031	.79	.060	1.52	.627	15.93
			500	152.4	126.5	57.4									
			1000	304.8	251.0	114.0									
	8623		—	15	See Chart 2R (Tech Info Section)	100	30.5	32.5	14.8	.031	.79	.060	1.52	.694	17.63
			500	152.4	155.5	70.6									
			1000	304.8	314.0	142.6									
	8624		—	19	See Chart 2R (Tech Info Section)	100	30.5	36.8	16.7	.031	.79	.065	1.65	.740	18.80
			500	152.4	178.5	81.0									
			1000	304.8	361.0	164.0									
	9622		—	25	See Chart 2R (Tech Info Section)	100	30.5	49.0	22.2	.031	.79	.065	1.65	.879	22.33
			500	152.4	236.0	107.1									
			1000	304.8	480.0	217.9									

[†]Spools and/or UnReel® cartons are one piece, but length may vary ± 10% for spools and ± 5% for UnReel from length shown.

Unshielded

Audio, Control, Communication and Instrumentation Cables Non-Plenum

Description	Part No.	UL NEC/ C(UL) CEC Type	No. of Cond.	Color Code	Standard Lengths		Standard Unit Weight		Insulation Thickness		Jacket Thickness		Nominal OD	
					Ft.	m	Lbs.	kg	Inch	mm	Inch	mm	Inch	mm

14 AWG Stranded (19x27) Tinned Copper Conductors • Conductors Cabled

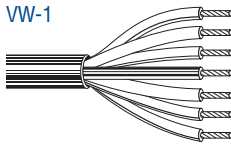
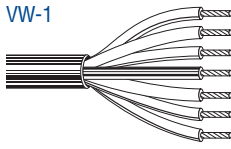
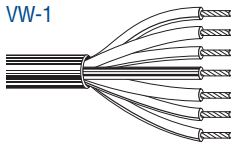
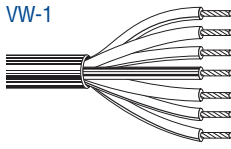
PVC Insulation • Chrome PVC Jacket														
	8627	—	4	See Chart 2 (Tech Info Section)	100	30.5	13.8	6.3	.045	1.14	.045	1.14	.490	12.45
					500	152.4	76.5	34.7						
					1000	304.8	149.0	67.6						
	9623	—	5	See Chart 2 (Tech Info Section)	100	30.5	18.1	8.3	.045	1.14	.060	1.52	.573	14.55
					500	152.4	99.5	45.1						
					1000	304.8	197.0	89.4						
	8628	—	7	See Chart 2 (Tech Info Section)	100	30.5	23.9	11.0	.045	1.14	.060	1.52	.623	15.82
					500	152.4	128.0	58.1						
					1000	304.8	255.0	115.8						
	8629	—	12	See Chart 2 (Tech Info Section)	100	30.5	44.6	20.2	.045	1.14	.065	1.65	.824	20.93
					500	152.4	222.0	100.8						
					1000	304.8	454.0	206.1						

Description	Part No.	UL NEC/ C(UL) CEC Type	No. of Cond.	Color Code	Standard Lengths		Standard Unit Weight		Insulation Thickness		Jacket Thickness		Nominal OD		Nominal Capacitance			
					Ft.	m	Lbs.	kg	Inch	mm	Inch	mm	Inch	mm	* pF/ Ft.	* pF/ m	** pF/ Ft.	** pF/ m

22 and 18 AWG Stranded (7x30 and 16x30) Tinned Copper Conductors • Conductors Cabled

PVC Insulation • Chrome PVC Jacket																					
	8446	NEC: CMG CEC: CMG FT4	6: 4 Unshld 22 (7x30) 2 Unshld 18 (16x30)	Red, Green, Brown, Blue Black, White	100	30.5	4.7	2.1	.010	.25	.032	.81	.236	5.99	30	98	54	177			
					U-500	U-152.4	21.5	9.8													
					500	152.4	21.5	9.8													
					U-1000	U-304.8	41.0	18.6	.019	.48											
					1000	304.8	43.0	19.5													

20 and 16 AWG Stranded (7x28 and 19x28) Tinned Copper Conductors • Conductors Cabled

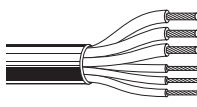
PVC Insulation • Chrome PVC Jacket																						
	9686	NEC: CM	6: 3 Unshld 20 (7x28) 3 Unshld 16 (19x28)	Green, Blue, Purple Black, Red, Yellow	U-500	U-152.4	32.5	14.7	.012	.30	.032	.81	.295	7.49	20	66	36	118				
													.013	.33					30	98	54	177

*Capacitance between conductors.
**Nominal capacitance conductor to conductor and shield.

4 • Multi-Conductor Cables



Unshielded

Antenna Rotor Control Cables, Security/Audio Systems and Duplex Primary Wire

Description	Part No.	UL NEC/ C(UL) CEC Type	No. of Cond.	Color Code	AWG (stranding)	Standard Lengths		Standard Unit Weight		Insulation Thickness		Jacket Thickness		Nominal OD	
						Ft.	m	Lbs.	kg	Inch	mm	Inch	mm	Inch	mm

Antenna Rotor Cables Stranded Tinned Copper Conductors • Conductors Cabled

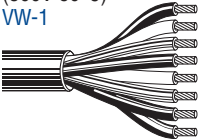
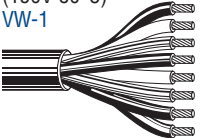
PVC Insulation • Chrome PVC Jacket															
UL AWM Style 2464 (300V 80°C) VW-1 	9405	NEC: CM	8	Black, White	2@16 (19x28)	500	152.4	47.0	21.3	.019	.48	.032	.81	.345	8.76
				Brown, Red, Yellow, Blue, Orange, Green	6@18 (16x30)	1000	304.8	92.0	41.8			.018	.46		
UL AWM Style 2576 (150V 80°C) VW-1 	8448	NEC: CMG CEC: CMG FT4	8	Black, White	2@18 (16x30)	U-500	U-152.4	25.0	11.4	.019	.48	.032	.81	.259	6.58
				Red, Green, Brown, Blue, Yellow, Orange	6@22 (7x30)	500	152.4	25.5	11.6			.010	.25		
						U-1000	U-304.8	49.0	22.2						
						1000	304.8	50.0	22.7						

Security/Audio/Power Limited Controls Cable Stranded Bare Copper Conductors • Conductors Parallel

PVC Insulation • Chrome PVC Jacket															
200V RMS 75°C VW-1 	8484	—	4	Black, Green, Red, White	20 (7x28)	U-500	U-152.4	12.5	5.7	—	—	—	—	.177	4.50
						500	152.4	12.5	5.7						
						U-1000	U-304.8	24.0	10.9						
						1000	304.8	25.0	11.4						

Duplex Primary Wire Stranded Bare Copper Conductors • Conductors Parallel

PVC Insulation • Chrome PVC Jacket															
300V RMS 75°C VW-1 	8677	—	2	Brown, Red	16 (19x29)	500	152.4	18.5	8.4	.024	.61	.022	.56	.149	3.78
														.254	6.45
	8675	—	2	Brown, Red	14 (19x27)	500	152.4	23.5	10.7	.023	.58	.023	.58	.168	4.27
														x	x
														.290	7.37
	8673	—	2	Brown, Red	12 (19x25)	500	152.4	32.5	14.8	.026	.66	.022	.56	.186	4.72
														x	x
														.328	8.33
	8678	—	2	Brown, Red	10 (19x23)	500	152.4	51.0	23.1	.031	.79	.025	.64	.225	5.72
														x	x
														.400	10.16

Unshielded

Power and Control Cables

Rubber and Oil-Resistant Rubber SO Cables

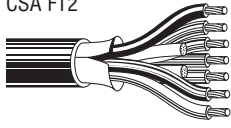
Description	Part No.	UL NEC/ C(UL) CEC Type	No. of Cond.	Color Code	Standard Lengths		Standard Unit Weight		Insulation Thickness		Jacket Thickness		Nominal OD		
					Ft.	m	Lbs.	kg	Inch	mm	Inch	mm	Inch	mm	
16 AWG Stranded (65x34) Bare Copper Conductors • Conductors Cabled with Fillers • Paper Tape Separator															
EPDM Rubber Insulation • Black Oil-resistant Rubber Jacket															
600V RMS 60°C CSA FT2 	9420	UL:	5	See Chart 2 (Tech Info Section)	100	30.5	13.3	6.0	.033	.838	.084	2.13	.506	12.85	
		SO			500	152.4	73.5	33.4							
		CSA: SO			1000	304.8	143.0	65.0							
	9422	UL:	7	See Chart 2 (Tech Info Section)	100	30.5	18.5	8.4	.033	.838	.083	2.11	.581	14.76	
		SO			500	152.4	101.0	45.9							
		CSA: SO			1000	304.8	201.0	91.3							
9424	UL:	9	See Chart 2 (Tech Info Section)	100	30.5	29.6	13.4	.033	.838	.100	2.54	.720*	18.29		
	SO			500	152.4	150.5	68.3								
	CSA: SO			1000	304.8	288.0	130.8								
9425	UL:	12	See Chart 2 (Tech Info Section)	100	30.5	32.6	14.8	.033	.838	.100	2.54	.720	18.29		
	SO			500	152.4	165.5	75.1								
	CSA: SO			1000	304.8	318.0	144.4								
9427	UL:	16	See Chart 2 (Tech Info Section)	100	30.5	39.5	17.9	.033	.838	.100	2.54	.787	19.99		
	SO			500	152.4	428.0	194.3								
	CSA: SO			1000	304.8	428.0	194.3								
9429	UL:	20	See Chart 2 (Tech Info Section)	100	30.5	48.4	22.0	.033	.838	.100	2.54	.862	21.89		
	SO			500	152.4	233.0	105.8								
	CSA: SO			1000	304.8	233.0	105.8								

EPDM = Ethylene Propylene Diene Monomer

*Fillers added in the center

Overall Beldfoil® Shield

Computer Cable for Synchronous EIA Interface

Description	Part No.	UL NEC/C(UL) CEC Type	No. of Cond.	Standard Lengths		Standard Unit Weight		Nominal OD		Nominal DCR		Nom. Imped. (Ω)	Nom. Vel. of Prop.	Nominal Capacitance			
				Ft.	m	Lbs.	kg	Inch	mm	Cond.	Shield			* pF/Ft.	* pF/m	** pF/Ft.	** pF/m

28 AWG Stranded (7x36) TC Conductors • Individually and Overall Beldfoil Shielded (100% Coverage) • 28 AWG Stranded TC Drain Wires

Datalene® Insulation • Gray PVC Jacket

UL AWM Style 2384 (30V 60°C)	9868	NEC: CM	14	1000	304.8	71.0	32.2	.394	10.01	64.9Ω/M' 212.9Ω/km	Individual: 44.0Ω/M' 144.4Ω/km Overall: 18.2Ω/M' 59.7Ω/km	65	78%	—	—	20.5	67.3
------------------------------	-------------	---------	----	------	-------	------	------	------	-------	-----------------------	--	----	-----	---	---	------	------

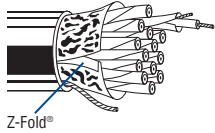

Individually Beldfoil shielded conductors are isolated from adjacent shields and each has a 28 AWG stranded TC drain wire.

DCR = DC Resistance • TC = Tinned Copper

*Capacitance between conductors.
**Nominal capacitance conductor to conductor and shield.

Datalene insulation features include a low dielectric constant and a low dissipation factor for high-speed, low-distortion data handling. Physical properties include good crush resistance and light weight.

Color Codes

Cond. No.	Color
1	Black w/ Blue Shield
2	Brown w/ Blue Shield
3	Red w/ Blue Shield
4	Orange w/ Blue Shield
5	Blue w/ Blue Shield
6	Yellow w/ Blue Shield
7	Natural w/ Blue Shield
8	Black w/ Red Shield
9	Brown w/ Red Shield
10	Red w/ Red Shield
11	Orange w/ Red Shield
12	Blue w/ Red Shield
13	Yellow w/ Red Shield
14	Natural w/ Red Shield



Overall Beldfoil® Shield

Computer Cables for EIA RS-232 Applications

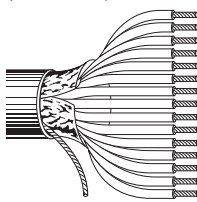
Description	Part No.	UL NEC/ C(UL) CEC Type	No. of Cond.	Color Code	Standard Lengths		Standard Unit Weight		Insulation Thickness		Jacket Thickness		Nominal OD		Nominal Capacitance			
					Ft.	m	Lbs.	kg	Inch	mm	Inch	mm	Inch	mm	pF/ Ft.	pF/ m	pF/ Ft.	pF/ m
24 AWG Stranded (7x32) TC Conductors • Conductors Cabled • Overall Beldfoil Shield (100% Coverage) • 24 AWG Stranded TC Drain Wire																		
Semi-rigid PVC Insulation • Chrome PVC Jacket																		
	UL AWM Style 2464 (300V 80°C)	9533	NEC: 3 CMG CEC: CMG FT4	See Chart 1 (Tech Info Section)	100 U-500 500 U-1000 1000	30.5 U-152.4 152.4 U-304.8 304.8	2.7 9.5 9.0 18.0 18.0	1.2 4.3 4.1 8.2 8.2	.010 .25 .032 .81 .162	.032 .81 .162	.162 4.11	33 108 65 213	33 108 65 213	65 213	65 213	213		
	9534	NEC: 4 CMG CEC: CMG FT4	See Chart 1 (Tech Info Section)	100 U-500 500 U-1000 1000	30.5 U-152.4 152.4 U-304.8 304.8	3.0 11.0 11.5 21.0 22.0	1.4 5.0 5.2 9.5 10.0	.010 .25 .032 .81 .184	.032 .81 .184	.184 4.67	33 108 65 213	33 108 65 213	65 213	65 213	213			
	9535	NEC: 5 CMG CEC: CMG FT4	See Chart 1 (Tech Info Section)	100 U-500 500 U-1000 1000	30.5 U-152.4 152.4 U-304.8 304.8	3.2 12.0 11.0 23.0 22.0	1.5 5.4 5.0 10.4 10.0	.010 .25 .032 .81 .189	.032 .81 .189	.189 4.80	33 108 65 213	33 108 65 213	65 213	65 213	213			
	9536	NEC: 6 CMG CEC: CMG FT4	See Chart 1 (Tech Info Section)	100 U-500 500 U-1000 1000	30.5 U-152.4 152.4 U-304.8 304.8	3.6 14.5 12.5 27.0 29.0	1.6 6.6 5.7 12.3 13.2	.010 .25 .032 .81 .209	.032 .81 .209	.209 5.31	33 108 65 213	33 108 65 213	65 213	65 213	213			
	9537	NEC: 7 CMG CEC: CMG FT4	See Chart 1 (Tech Info Section)	100 U-500 500 U-1000 1000	30.5 U-152.4 152.4 U-304.8 304.8	3.7 15.0 13.5 29.0 30.0	1.7 6.8 6.2 13.2 13.7	.010 .25 .032 .81 .209	.032 .81 .209	.209 5.31	33 108 65 213	33 108 65 213	65 213	65 213	213			
	9538	NEC: 8 CMG CEC: CMG FT4	See Chart 1 (Tech Info Section)	100 U-500 500 U-1000 1000	30.5 U-152.4 152.4 U-304.8 304.8	3.8 17.0 15.0 32.0 34.0	1.7 7.7 6.8 14.6 15.4	.010 .25 .032 .81 .224	.032 .81 .224	.224 5.69	33 108 65 213	33 108 65 213	65 213	65 213	213			
	9539	NEC: 9 CMG CEC: CMG FT4	See Chart 1 (Tech Info Section)	100 U-500 500 U-1000 1000	30.5 U-152.4 152.4 U-304.8 304.8	4.2 20.0 17.0 37.0 38.0	1.9 9.1 7.8 16.9 17.3	.010 .25 .032 .81 .244	.032 .81 .244	.244 6.20	30 98 55 180	30 98 55 180	55 180	55 180	180			
	9540	NEC: 10 CMG CEC: CMG FT4	See Chart 1 (Tech Info Section)	100 U-500 500 U-1000 1000	30.5 U-152.4 152.4 U-304.8 304.8	4.3 19.5 18.0 38.0 36.0	2.0 8.9 8.2 17.2 16.4	.010 .25 .032 .81 .244	.032 .81 .244	.244 6.20	30 98 55 180	30 98 55 180	55 180	55 180	180			
	9541	NEC: 15 CMG CEC: CMG FT4	See Chart 2R (Tech Info Section)	100 U-500 500 U-1000 1000	30.5 U-152.4 152.4 U-304.8 304.8	5.9 27.5 28.0 54.0 56.0	2.7 12.5 12.7 24.5 25.4	.010 .25 .032 .81 .284	.032 .81 .284	.284 7.21	30 98 55 180	30 98 55 180	55 180	55 180	180			
	9542	NEC: 20 CMG CEC: CMG FT4	See Chart 2R (Tech Info Section)	100 U-500 500 U-1000 1000	30.5 U-152.4 152.4 U-304.8 304.8	7.3 34.0 35.5 69.0 69.0	3.3 15.4 16.1 31.3 31.3	.010 .25 .032 .81 .314	.032 .81 .314	.314 7.98	30 98 55 180	30 98 55 180	55 180	55 180	180			
9543	NEC: 25 CMG CEC: CMG FT4	See Chart 2R (Tech Info Section)	100 U-500 500 U-1000 1000	30.5 U-152.4 152.4 U-304.8 304.8	8.7 44.0 44.0 86.0 86.0	4.0 20.0 20.0 39.0 39.0	.010 .25 .032 .81 .339	.032 .81 .339	.339 8.61	30 98 55 180	30 98 55 180	55 180	55 180	180				
9544	NEC: 30 CMG CEC: CMG FT4	See Chart 2R (Tech Info Section)	100 U-500 500 U-1000 1000	30.5 U-152.4 152.4 U-304.8 304.8	10.3 51.5 51.5 102.0 102.0	4.7 23.4 23.4 46.3 46.3	.010 .25 .040 1.02 .380	.032 .81 1.02 .380	.380 9.65	30 98 55 180	30 98 55 180	55 180	55 180	180				
9545	NEC: 40 CMG CEC: CMG FT4	See Chart 2R (Tech Info Section)	100 U-500 500 U-1000 1000	30.5 U-152.4 152.4 U-304.8 304.8	13.5 65.0 65.0 130.0 130.0	6.1 29.5 29.5 59.0 59.0	.010 .25 .040 1.02 .430	.032 .81 1.02 .430	.430 10.92	30 98 55 180	30 98 55 180	55 180	55 180	180				
9546	NEC: 50 CMG CEC: CMG FT4	See Chart 2R (Tech Info Section)	100 U-500 500 U-1000 1000	30.5 U-152.4 152.4 U-304.8 304.8	16.4 81.5 81.5 168.0 168.0	7.4 37.0 37.0 76.3 76.3	.010 .25 .045 1.14 .490	.032 .81 1.14 .490	.490 12.45	30 98 55 180	30 98 55 180	55 180	55 180	180				

TC = Tinned Copper

*Capacitance between conductors. **Capacitance between one conductor and other conductors connected to shield.



For more information, contact Belden Technical Support: 1-800-BELDEN-1 • www.belden.com

Overall Beldfoil® Shield

Audio, Control and Instrumentation Cables

Non-Plenum

Description	Part No.	UL NEC/ C(UL) CEC Type	No. of Cond.	Color Code	Standard Lengths		Standard Unit Weight		Insulation Thickness		Jacket Thickness		Nominal OD		Nominal Capacitance			
					Ft.	m	Lbs.	kg	Inch	mm	Inch	mm	Inch	mm	* pF/ Ft.	* pF/ m	** pF/ Ft.	** pF/ m

22 AWG Stranded (7x30) TC Conductors • Conductors Cabled • Overall Beldfoil Shield (100% Coverage) • 22 AWG Stranded TC Drain Wire

Polypropylene Insulation • Brown PVC Jacket

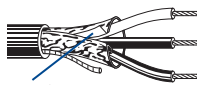
 <p>Z-Fold®</p>	300V RMS 9770	NEC: 3	Black, Red, White	U-500	U-152.4	9.0	4.1	.008	.20	.020	.51	.145	3.68	32	105	60	197			
		CM		500	152.4	9.0	4.1													
		CEC:		U-1000	U-304.8	18.0	8.2													
		CM		1000	304.8	17.0	7.7													

Polyethylene Insulation • Chrome PVC Jacket

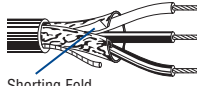
 <p>Shorting Fold</p>	UL AWM Style 2093 (300V 60°C) 8771	NEC: 3	Black, Red, Clear	250	76.2	6.3	2.8	.016	.41	.033	.84	.199	5.05	23	75	41	134			
		CM		U-500	U-152.4	12.0	5.5													
		CEC:		500	152.4	12.0	5.5													
		CM		U-1000	U-304.8	23.0	10.4													
		CM		1000	304.8	24.0	10.9													
				10000†	3048.0	240.0	109.1													

22 AWG Stranded (19x34) TC Conductors • Conductors Cabled • Overall Beldfoil Shield (100% Coverage) • 23 and 25 AWG Drain Wires††

Polyethylene Insulation • White PVC Jacket

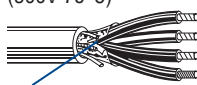
 <p>Z-Fold®</p>	UL AWM Style 2094 (300V 75°C) 8729	NEC: 4	Black, Red, Green, Clear	U-500	U-152.4	23.0	10.5	.016	.41	.051	1.30	.257	6.53	22	72	42	138			
		CM, CL3		500	152.4	21.5	9.8													
		CEC:		U-1000	U-304.8	45.0	20.4													
		CM		1000	304.8	47.0	21.4													

†† 8729 has three 23 AWG solid and one 25 AWG stranded tinned copper-coated steel drain wires.

20 AWG Stranded (7x28) TC Conductors • Conductors Cabled • Overall Beldfoil Shield (100% Coverage) • 20 AWG Stranded TC Drain Wire

Polyethylene Insulation • Chrome PVC Jacket

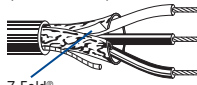
 <p>Z-Fold®</p>	UL AWM Style 2093 (300V 60°C) 8772	NEC: 3	Black, Red, Clear	U-500	U-152.4	16.0	7.3	.016	.41	.033	.84	.218	5.54	27	89	51	167			
		CM		500	152.4	16.0	7.3													
		CEC:		U-1000	U-304.8	31.0	14.1													
		CM		1000	304.8	32.0	14.5													

TC = Tinned Copper

*Capacitance between conductors.

**Nominal capacitance conductor to conductor and shield.

†Final put-up may vary -10% to +20%. May contain two pieces, minimum length of any one piece is 1500 ft.

Overall Beldfoil® Shield

Audio, Control and Instrumentation Cables

Plenum-Rated and Non-Plenum

Description	Part No.	UL NEC/ C(UL) CEC Type	No. of Cond.	Color Code	Standard Lengths		Standard Unit Weight		Insulation Thickness		Jacket Thickness		Nominal OD		Nominal Capacitance			
					Ft.	m	Lbs.	kg	Inch	mm	Inch	mm	Inch	mm	* pF/ Ft.	* pF/ m	** pF/ Ft.	** pF/ m

18 AWG Stranded (16x30) TC Conductors • Conductors Cabled • Overall Beldfoil Shield (100% Coverage) • 20 AWG Stranded TC Drain Wire

Polyethylene Insulation • Chrome PVC Jacket

 <p>Shorting Fold</p>	8770	UL AWM Style 2093 (300V 60°C)	NEC: 3	Black,	U-500	U-152.4	20.0	9.1	.018	.46	.033	.84	.246	6.25	24	79	48	157	
		CM	Red,	500	152.4	20.5	9.3												
		CEC:	Clear	U-1000	U-304.8	38.0	17.2												
		CM		1000	304.8	40.0	18.2												
					10000††	3048.0	430.0	195.5											

For Plenum version of 8770, see 8770.

18 AWG Stranded (19x30) TC Conductors • Conductors Cabled • Overall Beldfoil Shield (100% Coverage) • 20 AWG Stranded TC Drain Wire

Semi-rigid PVC Insulation • Chrome PVC Jacket

 <p>Z-Fold®</p>	9418	UL AWM Style 2464 (300V 80°C)	NEC: 4	Red,	100	30.5	5.6	2.6	.010	.25	.035	.89	.245	6.22	70	230	120	394
		CMG	Green,	U-500	U-152.4	18.0	8.2											
		CEC:	Black,	500	152.4	24.5	11.1											
		CMG FT4	White	U-1000	U-304.8	35.0	16.0											
					1000	304.8	52.0	23.7										
					10000††	3048.0	510.0	231.3										

For Plenum versions of 9418, see 89418 or 82418.

Plenum • FEP Insulation • Red FEP Jacket

	88770	(-70°C to +200°C)	NEC: 3	Black,	500	152.4	16.0	7.3	.007	.18	.014	.36	.161	4.09	54	177	96	315
		CMP	White,	1000	304.8	32.0	14.6											
		CEC:	Red															
		CMP FT6																

Suitable for Outdoor and Direct Burial applications. Chemical Resistance: Gasoline and Oil.

	89418	(-70°C to +200°C)	NEC: 4	Black,	100	30.5	5.5	2.5	.007	.18	.014	.36	.177	4.50	30	98	57	187
		CMP	White,	500†	152.4	18.0	8.2											
		CEC:	Red,	1000†	304.8	36.0	16.4											
		CMP FT6	Green															

Suitable for Outdoor and Direct Burial applications. Chemical Resistance: Gasoline and Oil.

Plenum • FEP Insulation • Natural Flammarrest® Jacket

	82418	(-70°C to +200°C)	NEC: 4	Black,	U-1000▲	U-304.8	36.0	16.4	.007	.18	.014	.36	.176	4.47	30	98	63	207
		CMP	White,	1000†	304.8	38.0	17.2											
		CEC:	Red,															
		CMP FT6	Green															

16 AWG Stranded (19x29) TC Conductors • Conductors Cabled • Overall Beldfoil Shield (100% Coverage) • 18 AWG Stranded TC Drain Wire

Polyethylene Insulation • Chrome PVC Jacket

 <p>Z-Fold®</p>	8618	UL AWM Style 2107 (300V 60°C)	NEC: 3	Black,	U-500	U-152.4	31.0	14.1	.031	.79	.031	.79	.327	8.3	26	85	50	164
		CL3	Red,	500	152.4	32.5	14.8											
			Clear	1000	304.8	66.0	30.1											

TC = Tinned Copper

* Capacitance between conductors.

** Capacitance between one conductor and other conductors connected to shield.

† Spools and/or UnReel® cartons are one piece, but length may vary ±10% for spools and ±5% for UnReel from length shown.

†† Final put-up may vary -10% to +20%. May contain 2 pieces. Min. length 1500 ft.

▲ Final put-up may vary 0 to -10%.

Overall Braid and Special Shielding

Audio, Control and Instrumentation Cables
Non-Plenum

Description	Part No.	UL NEC/ C(UL) CEC Type	No. of Cond.	Color Code	Standard Lengths		Standard Unit Weight		Insulation Thickness		Jacket Thickness		Nominal OD		Nominal Capacitance			
					Ft.	m	Lbs.	kg	Inch	mm	Inch	mm	Inch	mm	* pF/ Ft.	* pF/ m	** pF/ Ft.	** pF/ m

30 AWG Stranded (7x38) TC Conductors • Conductors Cabled around Textile Strength Member • Paper Separator • TC Braid Shield (95% Coverage)

Polypropylene Insulation • Chrome PVC Jacket

200V RMS 105°C	8643	—	3	Black, Red, White	100 250	30.5 76.2	1.1 3.0	.5 1.4	.006 0.15	.014 .36	.096 2.44	25 82	43 141				
----------------	-------------	---	---	-------------------------	------------	--------------	------------	-----------	--------------	-------------	--------------	----------	-----------	--	--	--	--



Conductors cabled around textile strength member.

22 AWG Stranded (7x30) Tinned Copper Conductors • Conductors Cabled • Tinned Copper Braid Shield (70% Coverage)

PVC Insulation • Chrome PVC Jacket

UL AWM Style 2095 (300V 80°C)	8735	NEC: CMG CEC: CMG FT4	3	Black, Red, White	500 U-1000 1000	152.4 U-304.8 304.8	14.0 27.0 27.0	6.4 12.3 12.3	.015 .38	.025 .64	.202 5.13	34 112	60 197				
-------------------------------	-------------	--------------------------------	---	-------------------------	-----------------------	---------------------------	----------------------	---------------------	-------------	-------------	--------------	-----------	-----------	--	--	--	--



20 AWG Stranded (7x28) Tinned Copper Conductors • Tinned Copper Braid Shield (85% Coverage)

PVC Insulation • Chrome PVC Jacket

UL AWM Style 2464 (300V 80°C)	9260	NEC: CMG CEC: CMG FT4	6	See Chart 2 (Tech Info Section)	100	30.5	7.3	3.3	.016	.41	.032	.81	.305	7.75	26	85	50	164			
					500	152.4	35.5	16.1	1000	304.8	69.0	31.4									
	9261	NEC: CMG CEC: CMG FT4	12	See Chart 2R (Tech Info Section)	100	30.5	12.0	5.5	.016	.41	.040	1.02	.396	10.06	26	85	57	187			
					500	152.4	60.0	27.3	1000	304.8	119.0	54.1									



Combination Shielded/Unshielded • 22 AWG Stranded (7x30) TC Conductors • Conductors Cabled • TC Braid Shield (80% Coverage)†

PVC Insulation • Chrome PVC Jacket

UL AWM Style 2785 (300V 80°C)	8734	NEC: CM	3: 1 Shld 2 Unshld	Black, Red, White	U-1000 1000	U-304.8 304.8	23.0 21.0	10.4 9.6	.015 .38	.025 .64	.194 4.93	—	—	79	259				
-------------------------------	-------------	------------	--------------------------	-------------------------	----------------	------------------	--------------	-------------	-------------	-------------	--------------	---	---	----	-----	--	--	--	--



†Tinned copper braid shield over one conductor (80% coverage).

Overall Spiral Shield • 18 AWG Stranded (7x26) TC Conductors • Conductors Cabled • Tinned Copper Spiral Wrap (80% Coverage)

PVC Insulation • Chrome PVC Jacket

450V RMS 80°C VW-1	8791	—	3	Black, Red, White	500 U-1000 1000	152.4 U-304.8 304.8	23.0 44.0 46.0	10.4 20.0 20.9	.022 .56	.028 .71	.260 6.60	47	154	84	276				
-----------------------	-------------	---	---	-------------------------	-----------------------	---------------------------	----------------------	----------------------	-------------	-------------	--------------	----	-----	----	-----	--	--	--	--





TC = Tinned Copper

*Capacitance between conductors.

**Nominal capacitance conductor to conductor and shield.

Overall Braid Shield

MIL-W-16878 (Type B) Conductors, Shielded and Jacketed[†]
Communication and Instrumentation Cables

Description	Part No.	UL NEC/ C(UL) CEC Type	No. of Cond.	Color Code	Standard Lengths		Standard Unit Weight		Insulation Thickness		Jacket Thickness		Nominal OD		Nominal Capacitance							
					Ft.	m	Lbs.	kg	Inch	mm	Inch	mm	Inch	mm	pF/ Ft.	pF/ m	pF/ Ft.	pF/ m				
22 AWG Stranded (19x34) TC Conductors • .003" (.76mm) Clear Nylon Skin over Insulation • Tinned Copper Braid Shield (90% Coverage)																						
PVC Insulation • White PVC Jacket																						
600V RMS 105°C VW-1	9965	—	1	White	1000	304.8	10.0	4.5	.010	.25	.010	.25	.100	2.54	—	—	100	328				
					9966	—	2	White, Black	100	30.5	2.9	1.3	.010	.25	.020	.51	.176	4.47	52	171	87	285
									500	152.4	10.5	4.8										
					1000	304.8	19.0	8.7														
	9967	—	3 ^{††}	White, Black, Red	100	30.5	3.4	1.5	.010	.25	.020	.51	.184	4.67	45	148	88	289				
					500	152.4	13.0	5.9														
					1000	304.8	24.0	10.9														
	9968	—	4 ^{††}	White, Black, Red, Green	100	30.5	3.9	1.8	.010	.25	.020	.51	.200	5.08	42	138	69	226				
					500	152.4	14.5	6.6														
					1000	304.8	29.0	13.2														
20 AWG Stranded (19x32) Tinned Copper Conductors • .004" (.10mm) Clear Nylon Skin over Insulation • TC Braid Shield (90% Coverage)																						
PVC Insulation • White PVC Jacket																						
600V RMS 105°C VW-1	9961	—	1	White	500	152.4	4.5	2.0	.011	.27	.010	.25	.109	2.77	—	—	103	338				
					9962	—	2 ^{††}	White, Black	100	30.5	3.3	1.5	.011	.27	.020	.51	.192	4.88	53	174	91	299
									500	152.4	11.0	5.0										
					1000	304.8	22.0	10.0														
	9963	—	3 ^{††}	White, Black, Red	100	30.5	3.9	1.8	.011	.27	.025	.64	.210	5.33	49	161	84	276				
					500	152.4	14.5	6.6														
					1000	304.8	29.0	13.2														
	9964	—	4 ^{††}	White, Black, Red, Green	100	30.5	4.6	2.1	.011	.27	.025	.64	.226	5.74	40	131	100	328				
					500	152.4	18.0	8.2														
					1000	304.8	39.0	17.7														
16 AWG Stranded (19x29) Tinned Copper Conductors • .004" (.10mm) Clear Nylon Skin over Insulation • TC Braid Shield (90% Coverage)																						
PVC Insulation • White PVC Jacket																						
600V RMS 105°C VW-1	9951	—	1	White	1000	304.8	20.0	9.1	.012	.30	.016	.41	.143	3.63	—	—	138	453				
					9952	—	2 ^{††}	White, Black	100	30.5	4.6	2.1	.012	.30	.025	.64	.250	6.35	57	187	95	312
									500	152.4	19.0	8.7										
					1000	304.8	42.0	19.1														
	9953	—	3 ^{††}	White, Black, Red	100	30.5	5.2	2.4	.012	.30	.025	.64	.264	6.71	58	190	101	331				
					500	152.4	26.0	11.9														
					1000	304.8	56.0	25.5														
	9954	—	4 ^{††}	White, Black, Red, Green	100	30.5	7.7	3.5	.012	.30	.027	.69	.291	7.39	49	161	94	308				
					500	152.4	34.5	15.7														
					1000	304.8	73.0	33.1														

TC = Tinned Copper

* Capacitance between conductors.

** Capacitance between one conductor and other conductors connected to shield.

† Manufactured to Government specifications: MIL-W-16878 Rev. D.

†† Conductors cabled.

4 • Multi-Conductor Cables

Overall Foil/Braid Shield

Computer Cables for EIA RS-232 Applications and IEEE 488 Interface,
Low-Capacitance Computer Cables for EIA RS-232 and EIA RS-423 Applications

Description	Part No.	UL NEC/ C(UL) CEC Type	No. of Cond.	Color Code	Standard Lengths		Standard Unit Weight		Nominal OD		Nominal DCR		Nom. Vel. of Prop.	Nominal Capacitance			
					Ft.	m	Lbs.	kg	Inch	mm	Cond.	Shield		* pF/ Ft.	* pF/ m	** pF/ Ft.	** pF/ m

28 AWG Stranded (7x36) Tinned Copper Conductors • Overall Beldfoil® (100% Coverage) + Tinned Copper Braid Shield (65% Coverage)

Semi-rigid PVC Insulation • Chrome PVC Jacket

UL AWM Style 2464 (300V 80°C)	9637	NEC:	25	See	100	30.5	6.2	2.8	.305	7.75	64.9Ω/M'	4.5Ω/M'	66%	30	98	50	164
CSA AWM I B FT4		CL2		Chart 2R	500	152.4	30.0	13.6			212.9Ω/km	14.8Ω/km					
				(Tech Info Section)	1000	304.8	59.0	26.8									

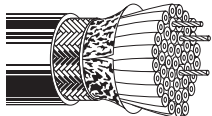

Low Cap 28 AWG Stranded (7x36) TC Conductors • Overall Beldfoil (100% Coverage) + TC Braid Shield (65% Coverage) • Drain Wire†

Datalene® Insulation • Chrome PVC Jacket

UL AWM Style 2919 (30V 80°C)	9791	NEC:	6	See	500	152.4	13.0	6.0	.225	5.72	64.9Ω/M'	6.15Ω/M'	78%	12	39.4	22	72.2
VW-1		CL2		Chart 1	1000	304.8	29.0	13.2			212.9Ω/km	20.2Ω/km					
				(Tech Info Section)													

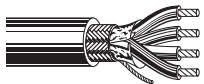

†28 AWG Stranded TC Drain Wire

IEEE 488 • 26 AWG & 24 AWG Stranded (7x34 & 7x32) TC Cond. • Overall Beldfoil (100% Coverage) + TC Braid Shield (90% Coverage) • Drain Wire

Semi-rigid PVC Insulation • Gray PVC Jacket

UL AWM Style 2464 (300V 80°C)	9641	NEC:	23:	See	1000	304.8	82.0	37.4	.350	8.89	26 AWG:	2.6Ω/M'	66%	—	—	—	—		
CSA AWM I A		CMG		(6)							Chart 1	37.3Ω/M'						8.5Ω/km	
		CEC:		26 AWG							(Tech Info Section)	122.4Ω/km							
		CMG FT4		Pairs							(10)	26 AWG						23.3Ω/M'	76.4Ω/km
				Cond.							(1)	24 AWG							
				Cond.															

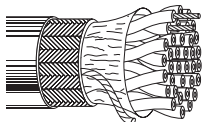

TC = Tinned Copper

*Capacitance between conductors.

**Capacitance between one conductor and other conductors connected to ground.

Datalene insulation features include a low dielectric constant and a low dissipation factor for high-speed, low-distortion data handling. Physical properties include good crush resistance and light weight.

Overall Foil/Braid Shield

Computer Cables for EIA RS-232 Applications

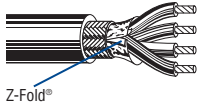
Description	Part No.	UL NEC/ C(UL) CEC Type	No. of Cond.	Color Code	Standard Lengths		Standard Unit Weight		Nominal OD		Nominal DCR		Nominal Capacitance			
					Ft.	m	Lbs.	kg	Inch	mm	Cond.	Shield	* pF/ Ft.	* pF/ m	** pF/ Ft.	** pF/ m
24 AWG Stranded (7x32) TC Conductors • Overall Beldfoil® (100% Coverage) + TC Braid Shield (65% Coverage)																
Semi-rigid PVC Insulation • Chrome PVC Jacket																
 <p>UL AWM Style 2464 (300V 80°C)</p> <p>Z-Fold®</p>	9608	NEC: CMG CEC: CMG FT4	3	See Chart 1 (Tech Info Section)	100 500 1000	30.5 152.4 304.8	3.1 12.0 23.0	1.4 5.4 10.4	.190 4.83	25.0Ω/M' 82.0Ω/km	9.8Ω/M' 32.2Ω/km	35	115	65	213	
	9609	NEC: CMG CEC: CMG FT4	4	See Chart 1 (Tech Info Section)	100 500 1000	30.5 152.4 304.8	3.5 13.5 26.0	1.6 6.1 11.8	.200 5.08	25.0Ω/M' 82.0Ω/km	9.8Ω/M' 32.2Ω/km	35	115	65	213	
	9610	NEC: CMG CEC: CMG FT4	5	See Chart 1 (Tech Info Section)	100 500 1000	30.5 152.4 304.8	4.0 16.0 32.0	1.8 7.3 14.5	.215 5.46	25.0Ω/M' 82.0Ω/km	6.5Ω/M' 21.3Ω/km	35	115	65	213	
	9611	NEC: CMG CEC: CMG FT4	6	See Chart 1 (Tech Info Section)	100 500 1000	30.5 152.4 304.8	4.2 17.0 34.0	1.9 7.7 15.4	.225 5.72	25.0Ω/M' 82.0Ω/km	7.0Ω/M' 23.0Ω/km	30	98.4	55	180	
	9612	NEC: CMG CEC: CMG FT4	7	See Chart 1 (Tech Info Section)	100 500 1000	30.5 152.4 304.8	4.2 18.5 38.0	1.9 8.4 17.3	.225 5.72	25.0Ω/M' 82.0Ω/km	6.9Ω/M' 22.6Ω/km	30	98.4	55	180	
	9613	NEC: CMG CEC: CMG FT4	8	See Chart 1 (Tech Info Section)	100 500 1000	30.5 152.4 304.8	4.5 21.0 41.0	2.0 9.5 18.6	.240 6.10	25.0Ω/M' 82.0Ω/km	7.3Ω/M' 23.9Ω/km	30	98.4	55	180	
	9614	NEC: CMG CEC: CMG FT4	9	See Chart 1 (Tech Info Section)	100 500 1000	30.5 152.4 304.8	4.8 22.0 44.0	2.2 10.0 20.0	.253 6.43	25.0Ω/M' 82.0Ω/km	7.5Ω/M' 24.6Ω/km	30	98.4	55	180	
	9615	NEC: CMG CEC: CMG FT4	10	See Chart 1 (Tech Info Section)	100 500 1000	30.5 152.4 304.8	5.4 25.0 50.0	2.5 11.4 22.7	.270 6.86	25.0Ω/M' 82.0Ω/km	6.9Ω/M' 22.6Ω/km	30	98.4	55	180	
	9616	NEC: CMG CEC: CMG FT4	15	See Chart 2R (Tech Info Section)	100 500 1000	30.5 152.4 304.8	6.6 31.5 63.0	3.0 14.3 28.6	.300 7.62	25.0Ω/M' 82.0Ω/km	6.9Ω/M' 22.6Ω/km	30	98.4	55	180	
	9617	NEC: CMG CEC: CMG FT4	25	See Chart 2R (Tech Info Section)	100 500 1000	30.5 152.4 304.8	10.1 49.5 100.0	4.6 22.5 45.4	.370 9.40	25.0Ω/M' 82.0Ω/km	5.1Ω/M' 16.7Ω/km	30	98.4	55	180	
9618	NEC: CMG CEC: CMG FT4	37	See Chart 2R (Tech Info Section)	100 500 1000	30.5 152.4 304.8	13.7 66.5 135.0	6.2 30.2 61.3	.411 10.43	25.0Ω/M' 82.0Ω/km	4.4Ω/M' 14.4Ω/km	30	98.4	55	180		
9619	NEC: CMG CEC: CMG FT4	50	See Chart 2R (Tech Info Section)	100 500 1000	30.5 152.4 304.8	17.2 93.0 182.0	7.8 42.2 82.6	.485 12.32	25.0Ω/M' 82.0Ω/km	4.3Ω/M' 14.1Ω/km	30	98.4	55	180		

DCR = DC Resistance • TC = Tinned Copper

* Capacitance between conductors.

** Nominal capacitance conductor to conductor and shield.

4 • Multi-Conductor Cables



Overall Foil/Braid Shield

Low-Capacitance Computer Cables for EIA RS-232 and EIA RS-423 Applications

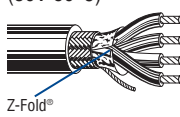
Description	Part No.	UL NEC/ C(UL) CEC Type	No. of Cond.	Color Code	Standard Lengths		Standard Unit Weight		Nominal OD		Nominal DCR		Nom. Vel. of Prop.	Nominal Capacitance			
					Ft.	m	Lbs.	kg	Inch	mm	Cond.	Shield		* pF/ Ft.	* pF/ m	** pF/ Ft.	** pF/ m
24 AWG Stranded (7x32) TC Conductors • Overall Beldfoil® (100% Coverage) + TC Braid Shield (65% Coverage) • Drain Wire††																	
Datalene® Insulation • Chrome PVC Jacket																	
UL AWM Style 2919 (30V 80°C) 	9925	NEC:	3	See	100	30.5	3.5	1.6	.215	5.46	24.0Ω/M'	5.2Ω/M'	78%	12	39.4	22	72.2
		CM:		Chart 1	500	152.4	12.0	5.5			78.7Ω/km	17.0Ω/km					
		CEC:		(Tech Info	1000	304.8	24.0	10.9									
		CM		Section)													
	9927	NEC:	4	See	100	30.5	3.6	1.6	.230	5.84	24.0Ω/M'	5.3Ω/M'	78%	12	39.4	22	72.2
		CM:		Chart 1	500	152.4	14.5	6.6			78.7Ω/km	17.4Ω/km					
		CEC:		(Tech Info	1000	304.8	32.0	14.5									
		CM		Section)													
	9929	NEC:	5	See	100	30.5	4.0	1.8	.246	6.25	24.0Ω/M'	4.2Ω/M'	78%	12	39.4	22	72.2
		CM:		Chart 1	500	152.4	16.0	7.3			78.7Ω/km	13.9Ω/km					
		CEC:		(Tech Info	1000	304.8	36.0	16.3									
		CM		Section)													
	9931	NEC:	6	See	100	30.5	4.2	1.9	.265	6.73	24.0Ω/M'	4.4Ω/M'	78%	12	39.4	22	72.2
		CM:		Chart 1	500	152.4	17.5	8.0			78.7Ω/km	14.4Ω/km					
		CEC:		(Tech Info	1000	304.8	39.0	17.7									
		CM		Section)	10000	3048.0	410.0	186.1									
	9932	NEC:	7	See	100	30.5	4.5	2.0	.265	6.73	24.0Ω/M'	4.4Ω/M'	78%	12	39.4	22	72.2
		CM:		Chart 1	500	152.4	18.5	8.4			78.7Ω/km	14.4Ω/km					
		CEC:		(Tech Info	1000	304.8	41.0	18.6									
		CM		Section)													
	9933	NEC:	8	See	100	30.5	4.9	2.2	.280	7.11	24.0Ω/M'	4.4Ω/M'	78%	12	39.4	22	72.2
		CM:		Chart 1	500	152.4	21.0	9.6			78.7Ω/km	14.4Ω/km					
		CEC:		(Tech Info	1000	304.8	46.0	20.9									
		CM		Section)	10000†	3048.0	480.0	217.9									
	9934	NEC:	9	See	100	30.5	5.2	2.4	.300	7.62	24.0Ω/M'	3.9Ω/M'	78%	12	39.4	22	72.2
		CM:		Chart 1	500	152.4	22.0	10.0			78.7Ω/km	12.6Ω/km					
		CEC:		(Tech Info	1000	304.8	48.0	21.8									
		CM		Section)													
	9935	NEC:	10	See	100	30.5	5.7	2.6	.306	7.77	24.0Ω/M'	3.2Ω/M'	78%	12	39.4	22	72.2
		CM:		Chart 1	500	152.4	28.0	12.7			78.7Ω/km	10.4Ω/km					
		CEC:		(Tech Info	1000	304.8	53.0	24.1									
		CM		Section)													
	9936	NEC:	15	See	100	30.5	7.2	3.3	.350	8.89	24.0Ω/M'	3.6Ω/M'	78%	12	39.4	22	72.2
		CM:		Chart 2R	500	152.4	35.0	15.9			78.7Ω/km	11.7Ω/km					
		CEC:		(Tech Info	1000	304.8	68.0	30.9									
		CM		Section)													
	9937	NEC:	25	See	100	30.5	9.9	4.5	.445	11.30	24.0Ω/M'	2.8Ω/M'	78%	12	39.4	22	72.2
		CM:		Chart 2R	500	152.4	54.5	24.8			78.7Ω/km	9.1Ω/km					
		CEC:		(Tech Info	1000	304.8	108.0	49.0									
		CM		Section)													
	9938	NEC:	37	See	100	30.5	12.9	5.9	.500	12.7	24.0Ω/M'	2.4Ω/M'	78%	12	39.4	22	72.2
		CM:		Chart 2R	500	152.4	71.5	32.5			78.7Ω/km	7.8Ω/km					
		CEC:		(Tech Info	1000	304.8	139.0	63.1									
		CM		Section)													

†24 AWG Stranded TC Drain Wire

DCR = DC Resistance • TC = Tinned Copper

*Capacitance between conductors.

**Nominal capacitance conductor to conductor and shield.

††Final put-up may vary -10% to +20%. May contain two pieces, minimum length of any one piece is 1500 ft.

Datalene insulation features include a low dielectric constant and a low dissipation factor for high-speed, low-distortion data handling. Physical properties include good crush resistance and light weight.

Overall Foil/Braid Shield

Computer Cables for EIA RS-232 Applications

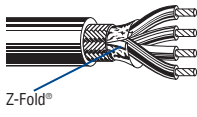
Description	Part No.	UL NEC/ C(UL) CEC Type	No. of Cond.	Color Code	Standard Lengths		Standard Unit Weight		Nominal OD		Nominal DCR		Nominal Capacitance			
					Ft.	m	Lbs.	kg	Inch	mm	Cond.	Shield	* pF/ Ft.	* pF/ m	** pF/ Ft.	** pF/ m
22 AWG Stranded (7x30) Tinned Copper Conductors • Overall Beldfoil® (100% Coverage) + Tinned Copper Braid Shield (65% Coverage)																
Semi-rigid PVC Insulation • Chrome PVC Jacket																
 <p>Z-Fold®</p>	9939	NEC: CMG CEC: CMG FT4	3	See Chart 1 (Tech Info Section)	100 500 1000	30.5 152.4 304.8	3.6 14.0 27.0	1.6 6.4 12.3	.202	5.13	14.7Ω/M' 48.2Ω/km	6.2Ω/M' 20.3Ω/km	37	121	67	220
	9940	NEC: CMG CEC: CMG FT4	4	See Chart 1 (Tech Info Section)	100 500 1000	30.5 152.4 304.8	4.0 16.5 32.0	1.8 7.5 14.5	.215	5.46	14.7Ω/M' 48.2Ω/km	5.0Ω/M' 16.4Ω/km	37	121	67	220
	9941	NEC: CMG CEC: CMG FT4	5	See Chart 1 (Tech Info Section)	100 500 1000	30.5 152.4 304.8	4.2 19.0 38.0	1.8 8.6 17.3	.230	5.84	14.7Ω/M' 48.2Ω/km	7.1Ω/M' 23.3Ω/km	37	121	67	220
	9942	NEC: CMG CEC: CMG FT4	6	See Chart 1 (Tech Info Section)	100 500 1000	30.5 152.4 304.8	4.7 22.0 43.0	2.1 10.0 19.5	.245	6.22	14.7Ω/M' 48.2Ω/km	7.9Ω/M' 25.9Ω/km	35	115	63	207
	9943	NEC: CMG CEC: CMG FT4	7	See Chart 1 (Tech Info Section)	100 500 1000	30.5 152.4 304.8	5.0 23.5 46.0	2.3 10.8 20.9	.245	6.22	14.7Ω/M' 48.2Ω/km	7.0Ω/M' 23.0Ω/km	35	115	63	207
	9944	NEC: CMG CEC: CMG FT4	8	See Chart 1 (Tech Info Section)	100 500 1000	30.5 152.4 304.8	5.5 26.0 52.0	2.5 11.8 23.6	.260	6.60	14.7Ω/M' 48.2Ω/km	6.0Ω/M' 19.7Ω/km	35	115	63	207
	9945	NEC: CMG CEC: CMG FT4	9	See Chart 1 (Tech Info Section)	100 500 1000	30.5 152.4 304.8	6.1 28.5 57.0	2.8 12.9 25.9	.280	7.11	14.7Ω/M' 48.2Ω/km	5.1Ω/M' 16.7Ω/km	35	115	63	207
	9946	NEC: CMG CEC: CMG FT4	10	See Chart 1 (Tech Info Section)	100 500 1000	30.5 152.4 304.8	6.6 31.5 62.0	3.0 14.3 28.1	.300	7.62	14.7Ω/M' 48.2Ω/km	4.6Ω/M' 15.1Ω/km	35	115	63	207
	9947	NEC: CMG CEC: CMG FT4	15	See Chart 2R (Tech Info Section)	100 500 1000	30.5 152.4 304.8	8.7 42.5 83.0	4.0 19.3 37.7	.340	8.64	14.7Ω/M' 48.2Ω/km	4.1Ω/M' 13.5Ω/km	35	115	63	207
	9948	NEC: CMG CEC: CMG FT4	25	See Chart 2R (Tech Info Section)	100 500 1000	30.5 152.4 304.8	13.3 66.5 132.0	6.0 30.2 59.9	.410	10.41	14.7Ω/M' 48.2Ω/km	3.1Ω/M' 10.2Ω/km	35	115	63	207
9949	NEC: CMG CEC: CMG FT4	37	See Chart 2R (Tech Info Section)	100 500 1000	30.5 152.4 304.8	16.1 87.5 180.0	7.3 39.7 81.7	.460	11.68	14.7Ω/M' 48.2Ω/km	2.7Ω/M' 8.9Ω/km	35	115	63	207	
9950	NEC: CMG CEC: CMG FT4	50	See Chart 2R (Tech Info Section)	100 500 1000	30.5 152.4 304.8	25.2 118.0 238.0	11.4 53.6 108.1	.555	14.10	14.7Ω/M' 48.2Ω/km	2.3Ω/M' 7.5Ω/km	35	115	63	207	

DCR = DC Resistance

*Capacitance between conductors.

**Nominal capacitance conductor to conductor and shield.

4 • Multi-Conductor Cables



Overall Shield

Special Audio, Communication and Instrumentation Cables

Description	Part No.	UL NEC/ C(UL) CEC Type	No. of Cond.	Color Code	Standard Lengths		Standard Unit Weight		Insulation Thickness		Jacket Thickness		Nominal OD		Nominal Capacitance				
					Ft.	m	Lbs.	kg	Inch	mm	Inch	mm	Inch	mm	* pF/ Ft.	* pF/ m	** pF/ Ft.	** pF/ m	
24 and 22 AWG Stranded (7x32 and 7x30) Tinned Copper Conductors • Cabled in Quads† • 24 AWG Stranded Tinned Copper Drain Wire																			
PVC Insulation (22 AWG) / Polyethylene Insulation (24 AWG) • Chrome PVC Jacket																			
350V RMS 80°C VW-1	8787	—	10:	Gray, White, Blue, Green	U-500	U-152.4	24.0	10.9	.012	.30	.030	.76	.290	7.37	—	—	—	—	
			4 Shld 24 (7x32)		500	152.4	22.5	10.3											
			4 Shld 24 (7x32)	Brown, Red, Yellow, Orange							.012	.30							
			2 Unshld 22 (7x30)	White, Blue					.015	.38									

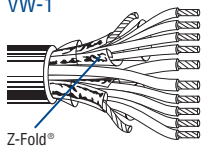

† Each quad wrapped in transparent polyester tape. Red Beldfoil® shield over one quad, Green Beldfoil shield over the other. (2) quads and (2) unshielded conductors cabled.

24 and 22 AWG Stranded (7x32 and 7x30) Tinned Copper Conductors • (4) Conductors Cabled†† • 22 AWG Stranded TC Drain Wire																			
PVC Insulation • Chrome PVC Jacket																			
300V 90°C NEC Article 800	8786	NEC: CM CEC: CM	6:	Black, Green, Red, Yellow	U-500	U-152.4	17.0	7.8	.015	.38	.028	.71	.236	5.99	—	—	—	—	
			4 Shld 24 (7x32)		500	152.4	16.5	7.5											
			2 Unshld 22 (7x30)	Blue, White															

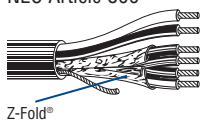

†† (4) conductors cabled under 100% Beldfoil shield; (2) conductors unshielded.

22 AWG Stranded (7x30) TC Conductors • (3) Conductors Cabled and Separately Beldfoil® Shielded (100% Coverage) with Drain Wires* [‡]																			
PVC Insulation • Chrome PVC Jacket																			
300V RMS 60°C VW-1	8788	NEC: CM	5:	Black, Red, Green	500	152.4	15.5	7.1	.015	.38	.028	.71	.236	5.99	34	112	—	—	
			3 Shld																
			2 Unshld*	Yellow, Blue															

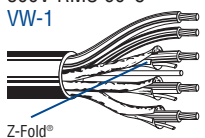

* (2) Unshielded conductors cabled around a non-hygroscopic filler.
[‡] Drain wire for each conductor is tinned cadmium bronze ribbon under 100% Beldfoil shield coverage.

22 AWG Triads Stranded (7x30) Tinned Copper Conductors • Cabled in Triads* • 22 AWG Stranded Tinned Copper Drain Wire																		
Polypropylene Insulation • Overall Chrome PVC Jacket																		
300V RMS 80°C VW-1	9772	—	36	Black, Red, Green, Triads w/Color Coded Jackets	500	152.4	139.0	63.2	.008	.20	.060	1.52	.725	18.42	34	112	67	220
			(12 triads)															

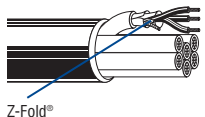

* Each triad shielded with 100% Beldfoil shield and drain wire, encased in a .020" white PVC jacket with color coded stripes.

TC = Tinned Copper
 * Capacitance between conductors.
 ** Nominal capacitance conductor to conductor and shield.

⚠ Not RoHS compliant at time of printing. Please check with Belden Technical Support for current compliance information at 1-800-BELDEN-1.

Overall Shield

Data Cables for Molex SEMMCONN and AMP® SDL Connectors
Computers, Instrumentation and Medical Electronics Interconnect Cables

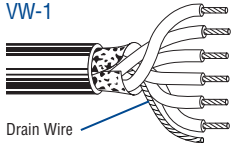
Description	Part No.	UL NEC/ C(UL) CEC Type	No. of Cond.	Color Code	Standard Lengths		Standard Unit Weight		Insulation Thickness		Jacket Thickness		Nominal OD	
					Ft.	m	Lbs.	kg	Inch	mm	Inch	mm	Inch	mm
26 AWG Stranded (7x34) Tinned Copper Conductors • Duofoil® Shield (100% Coverage) • 26 AWG Stranded Tinned Copper Drain Wire														
PVC Insulation • Black PVC Jacket														
UL AWM Style 2464 (300V 80°C) VW-1  Drain Wire	1211A	NEC: CL2X	4	White, Yellow, Orange, Green	500 1000	152.4 304.8	12.0 23.0	5.4 10.4	.015 .38	.036 .91	.195	4.95		
	1212A	NEC: CL2X	6	Red, Blue, Green, Orange, Yellow, White	500 1000	152.4 304.8	14.5 30.0	6.6 13.6	.015 .38	.037 .93	.220	5.59		
	1213A	NEC: CL2X	8	Black, Purple, Red, Blue, Green, Orange, Yellow, White	500 1000	152.4 304.8	12.0 24.0	5.4 10.4	.015 .38	.039 .98	.239	6.07		
	1214A	NEC: CL2X	16	White & Red, White & Brown, White & Black, Black, Red, Brown, Purple, Blue, Green, Gray, Aqua, Tan, Pink, Orange, White, Yellow	1000	304.8	57.0	25.9	.015 .38	.035 .89	.301	7.65		

AMP is a registered trademark of AMP, Inc.

Overall Shield

Direct Burial Cables

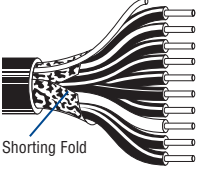
Description	Part No.	UL NEC/C(UL) CEC Type	No. of Cond.	Color Code	Standard Lengths		Standard Unit Weight		Insulation Thickness		Jacket Thickness		Nominal OD		Nominal Capacitance							
					Ft.	m	Lbs.	kg	Inch	mm	Inch	mm	Inch	mm	* pF/Ft.	* pF/m	** pF/Ft.	** pF/m				
20 AWG Solid Tinned Copper Conductors • Conductors Cabled • Overall Beldfoil® Shield (100% Coverage) • 22 AWG Solid TC Drain Wire																						
Polypropylene Insulation • Black HDPE Jacket																						
350V 80°C 	9802	—	2	White, Black	500	152.4	9.0	4.1	.013	.33	.035	.89	.190	4.83	32	104	42	138				
					1000	304.8	18.0	8.2														
Polypropylene Insulation • Black HDPE Jacket																						
350V RMS 	9803	—	3	White, Red, Black	1000	304.8	23.0	10.5	.013	.33	.035	.89	.205	5.21	23	75	42	138				
					9890	—	10	See Chart 1 (Tech Info Section)	500	152.4	33.0	15.0	.013	.33	.040	1.02	.310	7.87	23	75	42	138
									1000	304.8	65.0	29.5										
9894	—	15	See Chart 2 (Tech Info Section)	1000	304.8	96.0	43.6	.013	.33	.045	1.14	.390	9.91	23	75	42	138					

HDPE = High-density Polyethylene • TC = Tinned Copper
 *Capacitance between conductors.
 **Nominal capacitance conductor to conductor and shield.

Plenum-Rated

Unshielded

Audio, Control and Instrumentation Cables

Description	Part No.	UL NEC/ C(UL) CEC Type	No. of Cond.	Color Code	Standard Lengths		Standard Unit Weight		Insulation Thickness		Jacket Thickness		Nominal OD	
					Ft.	m	Lbs.	kg	Inch	mm	Inch	mm	Inch	mm

22 AWG Stranded (7x30) Tinned Copper Conductors • Conductors Cabled

Plenum • FEP Insulation • Red FEP Jacket

300V RMS	88444	NEC: CMP CEC: CMP FT6	4	Black, White, Red, Green	100 500 [†] 1000 [†]	30.5 152.4 304.8	2.9 9.0 15.0	1.3 4.1 6.8	.006 .15 .010	.15 .25	.121	3.07
----------	--------------	--------------------------------	---	-----------------------------------	--	------------------------	--------------------	-------------------	---------------------	------------	------	------



Suitable for Outdoor and Direct Burial applications.

Plenum • FEP Insulation • Natural Flamarrest® Jacket

300V RMS	82444	NEC: CMP CEC: CMP FT6	4	Black, White, Red, Green	U-500 [†] U-1000 [†] 1000 [†]	U-152.4 U-304.8 304.8	9.0 16.0 15.0	4.1 7.3 6.8	.006 .15	.015 .38	.134	3.40
----------	--------------	--------------------------------	---	-----------------------------------	--	-----------------------------	---------------------	-------------------	-------------	-------------	------	------



22 AWG Stranded (7x30) Tinned Copper Conductors • Twisted Pairs

Plenum • FEP Insulation • Red FEP Jacket

300V RMS	88442	NEC: CMP CEC: CMP FT6	2	Black, Red	100 500 [†] 1000 [†]	30.5 152.4 304.8	2.3 5.5 8.0	1.0 2.5 3.7	.006 .15	.012 .30	.102	2.59
----------	--------------	--------------------------------	---	---------------	--	------------------------	-------------------	-------------------	-------------	-------------	------	------



Suitable for Outdoor and Direct Burial applications.

Plenum • FEP Insulation • Natural Flamarrest Jacket

300V RMS	82442	NEC: CMP CEC: CMP FT6	2	Black, Red	U-1000 [†] 1000 [†]	U-304.8 304.8	9.0 8.0	4.1 3.7	.006 .15	.015 .38	.113	2.87
----------	--------------	--------------------------------	---	---------------	--	------------------	------------	------------	-------------	-------------	------	------



18 AWG Stranded (19x30) Tinned Copper Conductors • Conductors Cabled

Plenum • FEP Insulation • Red FEP Jacket

300V RMS	88489	NEC: CMP CEC: CMP FT6	4	Black, White, Red, Green	500 [†] 1000 [†]	152.4 304.8	14.5 29.0	6.6 13.2	.007 .18	.009 .23	.161	4.09
----------	--------------	--------------------------------	---	-----------------------------------	---------------------------------------	----------------	--------------	-------------	-------------	-------------	------	------



Suitable for Outdoor and Direct Burial applications.

Plenum • FEP Insulation • Natural Flamarrest Jacket

300V RMS	82489	NEC: CMP CEC: CMP FT6	4	Black, White, Red, Green	U-1000 [†] 1000 [†]	U-304.8 304.8	31.0 29.0	14.1 13.2	.007 .18	.014 .36	.170	4.32
----------	--------------	--------------------------------	---	-----------------------------------	--	------------------	--------------	--------------	-------------	-------------	------	------



[†]Spools and/or UnReel® cartons are one piece, but length may vary ±10% for spools and ±5% for UnReel from length shown.

4 • Multi-Conductor Cables



Plenum-Rated

Overall Beldfoil® Shield

Audio, Control and Instrumentation Cables

Description	Part No.	UL NEC/ C(UL) CEC Type	No. of Cond.	Color Code	Standard Lengths		Standard Unit Weight		Insulation Thickness		Jacket Thickness		Nominal OD		Nominal Capacitance			
					Ft.	m	Lbs.	kg	Inch	mm	Inch	mm	Inch	mm	* pF/ Ft.	* pF/ m	** pF/ Ft.	** pF/ m

18 AWG Stranded (19x30) TC Conductors • Conductors Cabled • Overall Beldfoil Shield (100% Coverage) • 20 AWG Stranded TC Drain Wire

Plenum • FEP Insulation • Red FEP Jacket

	88770	NEC:	3	Black, White, Red	500 [†]	152.4	16.0	7.3	.007	.18	.014	.36	.161	4.09	54	177	96	315
		CMP:			1000 [†]	304.8	32.0	14.6										
		CEC:																
		CMP FT6																
	89418	NEC:	4	Black, White, Red, Green	100	30.5	5.5	2.5	.007	.18	.014	.36	.177	4.50	30	98	57	187
		CMP:			500 [†]	152.4	18.0	8.2										
		CEC:																
		CMP FT6																

Suitable for Outdoor and Direct Burial applications.

Plenum • FEP Insulation • Natural Flamarrest® Jacket

	82418	NEC:	4	Black, White, Red, Green	U-1000 ^{††}	U-304.8	36.0	16.4	.007	.18	.014	.36	.176	4.47	30	98	63	207
		CMP:			1000 [†]	304.8	38.0	17.3										
		CEC:																
		CMP FT6																

Suitable for Outdoor applications.

TC = Tinned Copper

*Capacitance between conductors.

**Capacitance between one conductor and other conductors connected to shield.

[†]Spools and/or UnReel® cartons are one piece, but length may vary ±10% for spools and ±5% for UnReel from length shown.

^{††}Length may vary 0 to -10%.

Plenum-Rated

Overall Foil/Braid Shield

Audio, Control and Instrumentation Cables

Description	Part No.	UL NEC/ C(UL) CEC Type	No. of Cond.	Color Code	Standard Lengths		Standard Unit Weight		Insulation Thickness		Jacket Thickness		Nominal OD		Nominal Capacitance			
					Ft.	m	Lbs.	kg	Inch	mm	Inch	mm	Inch	mm	pF/ Ft.	pF/ m	pF/ Ft.	pF/ m

24 AWG Stranded (7x32) TC Conductors • Conductors Cabled • Overall Beldfoil® (100% Coverage) + TC Braid Shield (85% Coverage)

Plenum • FEP Insulation • Red FEP Jacket																			
	300V RMS	83503	NEC: CMP CEC: CMP FT6	3	See Chart 2 (Tech Info Section)	500 [†] 1000 [†]	152.4 304.8	9.5 16.0	4.3 7.3	.006	.15	.014	.36	.135	3.43	20	66	36	118
		83504	NEC: CMP CEC: CMP FT6	4	See Chart 2 (Tech Info Section)	100 500 [†] 1000 [†]	30.5 152.4 304.8	3.5 10.0 20.0	1.6 4.6 9.1	.006	.15	.014	.36	.144	3.66	20	66	36	118
		83506	NEC: CMP CEC: CMP FT6	6	See Chart 2 (Tech Info Section)	500 [†] 1000 [†]	152.4 304.8	13.0 26.0	6.0 11.9	.006	.15	.014	.36	.165	4.19	20	66	36	118
		83509	NEC: CMP CEC: CMP FT6	9	See Chart 2 (Tech Info Section)	100 500 [†] 1000 [†]	30.5 152.4 304.8	5.3 17.0 38.0	2.4 7.8 17.3	.006	.15	.014	.36	.188	4.78	20	66	36	118
		83512	NEC: CMP CEC: CMP FT6	12	See Chart 2 (Tech Info Section)	500 [†] 1000 [†]	152.4 304.8	21.0 45.0	9.6 20.4	.006	.15	.014	.36	.207	5.26	20	66	36	118
		83515	NEC: CMP CEC: CMP FT6	15	See Chart 2 (Tech Info Section)	100 500 [†] 1000 [†]	30.5 152.4 304.8	7.2 25.0 53.0	3.3 11.4 24.1	.006	.15	.014	.36	.227	5.77	20	66	36	118

Suitable for Outdoor and Direct Burial applications.

22 AWG Stranded (7x30) TC Conductors • Conductors Cabled • Overall Beldfoil (100% Coverage) + TC Braid Shield (85% Coverage)

Plenum • FEP Insulation • Red FEP Jacket																			
	300V RMS	83552	NEC: CMP CEC: CMP FT6	2	See Chart 2 (Tech Info Section)	500 [†] 1000 [†]	152.4 304.8	8.0 16.0	3.7 7.3	.006	.15	.014	.36	.141	3.58	23	75	40	131
		83553	NEC: CMP CEC: CMP FT6	3	See Chart 2 (Tech Info Section)	100 500 [†] 1000 [†]	30.5 152.4 304.8	3.5 11.5 20.0	1.6 5.2 9.1	.006	.15	.014	.36	.148	3.76	23	75	40	131
		83554	NEC: CMP CEC: CMP FT6	4	See Chart 2 (Tech Info Section)	100 500 [†] 1000 [†]	30.5 152.4 304.8	4.0 12.5 25.0	1.8 5.7 11.4	.006	.15	.014	.36	.159	4.04	23	75	40	131
		83556	NEC: CMP CEC: CMP FT6	6	See Chart 2 (Tech Info Section)	100 500 [†] 1000 [†]	30.5 152.4 304.8	5.2 16.5 36.0	2.4 7.5 16.3	.006	.15	.014	.36	.183	4.65	23	75	40	131
		83559	NEC: CMP CEC: CMP FT6	9	See Chart 2 (Tech Info Section)	100 500 [†] 1000 [†]	30.5 152.4 304.8	6.8 23.0 50.0	3.1 10.5 22.7	.006	.15	.014	.36	.209	5.31	23	75	40	131
		83562	NEC: CMP CEC: CMP FT6	12	See Chart 2 (Tech Info Section)	500 [†] 1000 [†]	152.4 304.8	28.5 60.0	13.0 27.2	.006	.15	.015	.38	.234	5.94	23	75	40	131
	83569	NEC: CMP CEC: CMP FT6	19	See Chart 2 (Tech Info Section)	100 500 [†] 1000 [†]	30.5 152.4 304.8	9.6 44.0 85.0	4.4 20.0 38.6	.006	.15	.015	.38	.269	6.83	23	75	40	131	

Suitable for Outdoor and Direct Burial applications.

* Capacitance between conductors. ** Capacitance between one conductor and other conductors connected to shield.
[†] Spools are one piece, but length may vary ±10% from length shown.

TC = Tinned Copper



Plenum-Rated

Overall Foil/Braid Shield

Audio, Control and Instrumentation Cables

Description	Part No.	UL NEC/ C(UL) CEC Type	No. of Cond.	Color Code	Standard Lengths		Standard Unit Weight		Insulation Thickness		Jacket Thickness		Nominal OD		Nominal Capacitance			
					Ft.	m	Lbs.	kg	Inch	mm	Inch	mm	Inch	mm	* pF/ Ft.	* pF/ m	** pF/ Ft.	** pF/ m

20 AWG Stranded (7x28) TC Conductors • Conductors Cabled • Overall Beldfoil® (100% Coverage) + TC Braid Shield (85% Coverage)

Plenum • FEP Insulation • Red FEP Jacket

	300V RMS	83602	NEC: CMP CEC: CMP FT6	2	See Chart 2 (Tech Info Section)	500† 1000†	152.4 304.8	11.0 22.0	5.0 10.0	.006 .15	.014 .36	.157 .178	3.99 4.52	26	85	51	167
		83604	NEC: CMP CEC: CMP FT6	4	See Chart 2 (Tech Info Section)	100 500† 1000†	30.5 152.4 304.8	5.1 16.0 32.0	2.3 7.3 14.6	.006 .15	.014 .36	.178 .207	4.52 5.26	26	85	51	167
		83606	NEC: CMP CEC: CMP FT6	6	See Chart 2 (Tech Info Section)	100 500† 1000†	30.5 152.4 304.8	6.2 21.5 47.0	2.8 9.8 21.3	.006 .15	.014 .36	.207 .238	5.26 6.05	26	85	51	167
		83609	NEC: CMP CEC: CMP FT6	9	See Chart 2 (Tech Info Section)	100 500† 1000†	30.5 152.4 304.8	8.2 30.0 63.0	3.7 13.7 28.6	.006 .15	.014 .36	.238 .265	6.05 6.73	26	85	51	167
		83612	NEC: CMP CEC: CMP FT6	12	See Chart 2 (Tech Info Section)	100 500† 1000†	30.5 152.4 304.8	7.8 35.0 67.0	3.5 15.9 30.4	.006 .15	.014 .36	.265 .293	6.73 7.44	26	85	51	167

Suitable for Outdoor and Direct Burial applications.

18 AWG Stranded (19x30) TC Conductors • Conductors Cabled • Overall Beldfoil (100% Coverage) + TC Braid Shield (85% Coverage)

Plenum • FEP Insulation • Red FEP Jacket

	300V RMS	83652	NEC: CMP CEC: CMP FT6	2	See Chart 2 (Tech Info Section)	100 500† 1000†	30.5 152.4 304.8	4.6 13.5 27.0	2.1 6.1 12.3	.007 .18	.014 .36	.175 .184	4.45 4.67	33	108	60	197
		83653	NEC: CMP CEC: CMP FT6	3	See Chart 2 (Tech Info Section)	100 500† 1000†	30.5 152.4 304.8	5.4 17.5 39.0	2.5 8.0 17.7	.007 .18	.014 .36	.184 .199	4.67 5.05	33	108	60	197
		83654	NEC: CMP CEC: CMP FT6	4	See Chart 2 (Tech Info Section)	100 500† 1000†	30.5 152.4 304.8	6.2 21.5 46.0	2.8 9.8 20.9	.007 .18	.014 .36	.199 .234	5.05 5.94	33	108	60	197
		83656	NEC: CMP CEC: CMP FT6	6	See Chart 2 (Tech Info Section)	100 500† 1000†	30.5 152.4 304.8	8.1 29.5 62.0	3.7 13.5 28.2	.007 .18	.014 .36	.234 .293	5.94 7.44	33	108	60	197
		83659	NEC: CMP CEC: CMP FT6	9	See Chart 2 (Tech Info Section)	100 500† 1000†	30.5 152.4 304.8	9.8 45.0 88.0	4.4 20.4 40.0	.007 .18	.015 .38	.293 .308	7.44 7.82	33	108	60	197
	83662	NEC: CMP CEC: CMP FT6	12	See Chart 2 (Tech Info Section)	100 500† 1000†	30.5 152.4 304.8	11.9 55.5 109.0	5.4 25.2 49.5	.007 .18	.015 .38	.308 .330	7.82 8.50	33	108	60	197	

Suitable for Outdoor and Direct Burial applications.

TC = Tinned Copper

*Capacitance between conductors.

**Capacitance between one conductor and other conductors connected to shield.

† Spools are one piece, but length may vary ±10% from length shown.

Plenum-Rated

Overall Foil/Braid Shield

Audio, Control and Instrumentation Cables

Description	Part No.	UL NEC/ C(UL) CEC Type	No. of Cond.	Color Code	Standard Lengths		Standard Unit Weight		Insulation Thickness		Jacket Thickness		Nominal OD		Nominal Capacitance			
					Ft.	m	Lbs.	kg	Inch	mm	Inch	mm	Inch	mm	* pF/ Ft.	* pF/ m	** pF/ Ft.	** pF/ m
16 AWG Stranded (19x29) TC Conductors • Conductors Cabled • Overall Beldfoil® (100% Coverage) + TC Braid Shield (85% Coverage)																		
Plenum • FEP Insulation • Red FEP Jacket																		
	300V RMS	83702	NEC: CMP CEC: CMP FT6	2	See Chart 2 (Tech Info Section)	100 500† 1000†	30.5 152.4 304.8	5.2 18.5 40.0	2.4 8.4 18.2	.007 .18 .18	.014 .36 .36	.196 4.98	35	115	63	207		
		83703	NEC: CMP CEC: CMP FT6	3	See Chart 2 (Tech Info Section)	500† 1000†	152.4 304.8	23.0 50.0	10.5 22.7	.007 .18	.014 .36	.206 5.23	35	115	63	207		
		83704	NEC: CMP CEC: CMP FT6	4	See Chart 2 (Tech Info Section)	100 500† 1000†	30.5 152.4 304.8	8.0 29.0 62.0	3.6 13.2 28.1	.007 .18 .18	.014 .36 .36	.223 5.66	35	115	63	207		
		83706	NEC: CMP CEC: CMP FT6	6	See Chart 2 (Tech Info Section)	100 500† 1000†	30.5 152.4 304.8	9.7 44.5 87.0	4.4 20.2 39.5	.007 .18 .18	.014 .36 .36	.265 6.73	35	115	63	207		
		83709	NEC: CMP CEC: CMP FT6	9	See Chart 2 (Tech Info Section)	100 500† 1000†	30.5 152.4 304.8	11.5 61.0 120.0	5.2 27.7 54.5	.007 .18 .18	.014 .36 .36	.307 7.80	35	115	63	207		
		83712	NEC: CMP CEC: CMP FT6	12	See Chart 2 (Tech Info Section)	100 500† 1000†	30.5 152.4 304.8	14.8 78.0 153.0	6.8 35.4 69.5	.007 .18 .18	.014 .36 .36	.344 8.74	35	115	63	207		
		83715	NEC: CMP CEC: CMP FT6	15	See Chart 2 (Tech Info Section)	100 500† 1000†	30.5 152.4 304.8	18.1 95.0 190.0	8.3 43.1 86.3	.007 .18 .18	.014 .36 .36	.407 10.34	35	115	63	207		
		83719	NEC: CMP CEC: CMP FT6	19	See Chart 2 (Tech Info Section)	100 500† 1000†	30.5 152.4 304.8	21.8 113.5 227.0	9.9 51.5 103.0	.007 .18 .18	.014 .36 .36	.403 10.24	35	115	63	207		

Suitable for Outdoor and Direct Burial applications.

TC = Tinned Copper

* Capacitance between conductors.

**Capacitance between one conductor and other conductors connected to shield.

† Spools are one piece, but length may vary ±10% from length shown.

High-Temperature

Unshielded

Control and Instrumentation Cables

Description	Part No.	UL NEC/ C(UL) CEC Type	No. of Cond.	Color Code	Standard Lengths		Standard Unit Weight		Insulation Thickness		Jacket Thickness		Nominal OD	
					Ft.	m	Lbs.	kg	Inch	mm	Inch	mm	Inch	mm

20 AWG Stranded (7x28) Tinned Copper Conductors • Conductors Cabled

Tefzel® Insulation • Clear Tefzel Jacket

300V RMS 150°C VW-1	85220	—	2	Black, Red	100 1000 [†]	30.5 304.8	3.8 23.0	1.7 10.4	.015	.38	.020	.51	.185	4.70
------------------------	--------------	---	---	---------------	--------------------------	---------------	-------------	-------------	------	-----	------	-----	------	------



16 AWG Stranded (19x29) Tinned Copper Conductors • Conductors Cabled

Tefzel Insulation • Clear Tefzel Jacket

300V RMS 150°C VW-1	85221	—	2	Black, Red	500 [†] 1000 [†]	152.4 304.8	15.0 34.0	6.8 15.4	.015	.38	.019	.48	.211	5.36
------------------------	--------------	---	---	---------------	---------------------------------------	----------------	--------------	-------------	------	-----	------	-----	------	------



85102	—	2	See Chart 2 (Tech Info Section)	500 [†] 1000 [†]	152.4 304.8	14.0 32.0	6.4 14.5	.015	.38	.019	.48	.211	5.36
--------------	---	---	--	---------------------------------------	----------------	--------------	-------------	------	-----	------	-----	------	------

85103	—	3	See Chart 2 (Tech Info Section)	500 [†] 1000 [†]	152.4 304.8	20.0 43.0	9.1 19.5	.015	.38	.019	.48	.223	5.66
--------------	---	---	--	---------------------------------------	----------------	--------------	-------------	------	-----	------	-----	------	------

85105	—	5	See Chart 2 (Tech Info Section)	500 [†] 1000 [†]	152.4 304.8	35.0 68.0	15.9 30.9	.015	.38	.019	.48	.268	6.81
--------------	---	---	--	---------------------------------------	----------------	--------------	--------------	------	-----	------	-----	------	------

85107	—	7	See Chart 2 (Tech Info Section)	100 1000 [†]	30.5 304.8	11.5 105.0	5.2 47.7	.015	.38	.024	.61	.303	7.70
--------------	---	---	--	--------------------------	---------------	---------------	-------------	------	-----	------	-----	------	------

85109	—	9	See Chart 2 (Tech Info Section)	500 [†] 1000 [†]	152.4 304.8	59.0 119.0	26.8 54.0	.015	.38	.024	.61	.354	8.99
--------------	---	---	--	---------------------------------------	----------------	---------------	--------------	------	-----	------	-----	------	------

[†] Spools are one piece, but length may vary ±10% from length shown.

Tefzel insulated and jacketed cables are particularly well suited for harsh environments due to outstanding mechanical toughness of the material, as well as its high-temperature and radiation resistant characteristics.

Tefzel cables are used extensively in chemical plants, nuclear plants, and fossil fuel power plants. Typical applications are data recording, communication, telemetry, and monitoring pressure or material flow.

Tefzel is a DuPont trademark.



For more information, contact **Belden Technical Support: 1-800-BELDEN-1 • www.belden.com**

High-Temperature

Overall Beldfoil® Shield

Control and Instrumentation Cables

Description	Part No.	UL NEC/ C(UL) CEC Type	No. of Cond.	Color Code	Standard Lengths		Standard Unit Weight		Insulation Thickness		Jacket Thickness		Nominal OD		Nominal Capacitance			
					Ft.	m	Lbs.	kg	Inch	mm	Inch	mm	Inch	mm	* pF/ Ft.	* pF/ m	** pF/ Ft.	** pF/ m

22 AWG Stranded (7x30) TC Conductors • Conductors Cabled • Special Beldfoil Shield (100% Coverage) • 22 AWG (7x30) Stranded TC Drain Wire

FEP Insulation • Red Silicone Rubber Jacket • Noise Reducing Tape

Jacket working voltage 2000V DC, shield to ground VW-1	83394	AWM 4516	2	Black, White	100 500†	30.5 U-152.4	3.6 14.5	1.6 6.6	.015 500†	.38 152.4	.030 13.0	.76 5.9	.199	5.05	22	72	40	131
--	--------------	-------------	---	-----------------	-------------	-----------------	-------------	------------	--------------	--------------	--------------	------------	------	------	----	----	----	-----



70°C (min.) to 150°C (max.) operating temperature.

Jacket working voltage 2000V DC, shield to ground VW-1	83395	AWM 4516	3	Black, Red, White	100 500†	30.5 152.4	3.9 14.0	1.8 6.4	.015	.38	.031	.79	.208	5.28	22	72	40	131
--	--------------	-------------	---	-------------------------	-------------	---------------	-------------	------------	------	-----	------	-----	------	------	----	----	----	-----



70°C (min.) to 150°C (max.) operating temperature.

Jacket working voltage 2000V DC, shield to ground VW-1	83396	AWM 4516	4	Black, White, Red, Green	100 500†	30.5 152.4	3.9 16.0	1.8 7.3	.015	.38	.030	.76	.217	5.51	22	72	40	131
--	--------------	-------------	---	-----------------------------------	-------------	---------------	-------------	------------	------	-----	------	-----	------	------	----	----	----	-----

20 AWG Stranded (7x28) TC Conductors • Twisted Pair • Special Beldfoil Shield (100% Coverage) • 20 AWG (7x28) Stranded TC Drain Wire

FEP Insulation • Yellow Silicone Rubber Jacket • Noise Reducing Tape

Jacket working voltage 2000V DC, shield to ground VW-1	83393	AWM 4516	2	Black, Red	100†† 500†	30.5 U-152.4	4.2 18.5	1.9 8.4	.020 500†	.51 152.4	.030 17.0	.76 7.8	.242	6.15	22	72	40	131
--	--------------	-------------	---	---------------	---------------	-----------------	-------------	------------	--------------	--------------	--------------	------------	------	------	----	----	----	-----



70°C (min.) to 150°C (max.) operating temperature.

20 AWG Stranded (7x28) TC Conductors • Conductors Cabled • Overall Beldfoil Shield (100% Coverage) • Drain Wire

Tefzel® Insulation • Clear Tefzel Jacket

300V RMS 150°C VW-1	85230	—	2	Black, Red	500† 1000†	152.4 304.8	12.5 29.0	5.7 13.2	.015	.38	.020	.51	.182	4.62	31	102	59	194
------------------------	--------------	---	---	---------------	---------------	----------------	--------------	-------------	------	-----	------	-----	------	------	----	-----	----	-----



300V RMS 150°C VW-1	85240	—	3	Black, Red, Green	100 1000†	30.5 304.8	4.6 30.0	2.1 13.6	.015	.38	.020	.51	.193	4.90	27	87	48	157
------------------------	--------------	---	---	-------------------------	--------------	---------------	-------------	-------------	------	-----	------	-----	------	------	----	----	----	-----



16 AWG Stranded (19x29) TC Conductors • Conductors Cabled • Overall Beldfoil Shield (100% Coverage) • Drain Wire

Tefzel Insulation • Clear Tefzel Jacket

300V RMS 150°C VW-1	85231	—	2	Black, Red	100 500† 1000†	30.5 152.4 304.8	5.6 17.0 38.0	2.5 7.8 17.3	.020	.51	.020	.51	.210	5.33	44	144	79	259
------------------------	--------------	---	---	---------------	----------------------	------------------------	---------------------	--------------------	------	-----	------	-----	------	------	----	-----	----	-----



300V RMS 150°C VW-1	85241	—	3	Black, Red, Green	500† 1000†	152.4 304.8	22.5 49.0	10.3 22.3	.020	.51	.020	.51	.223	5.66	34	112	61	201
------------------------	--------------	---	---	-------------------------	---------------	----------------	--------------	--------------	------	-----	------	-----	------	------	----	-----	----	-----



TC = Tinned Copper

*Capacitance between conductors. **Capacitance between one conductor and other conductors connected to shield.
†Spools and/or UnReel® cartons are one piece, but length may vary ±10% for spools and ±5% for UnReel from length shown.
††100 ft. put-up one piece, exact length.

Tefzel and Kapton are DuPont trademarks.

High-Temperature

Overall Braid Shield — Control and Instrumentation Cables MIL-W-16878/4 (Type E) — Individual Conductors

Description	Part No.	UL NEC/ C(UL) CEC Type	No. of Cond.	Color Code	Standard Lengths		Standard Unit Weight		Insulation Thickness		Jacket Thickness		Nominal OD		Nominal Capacitance			
					Ft.	m	Lbs.	kg	Inch	mm	Inch	mm	Inch	mm	pF/ Ft.	pF/ m	pF/ Ft.	pF/ m

26 AWG Stranded (7x34) Silver-plated Copper Conductors • Cabled and Color-coded • Silver-plated Copper Braid Shield (85% Coverage)

Extruded TFE Teflon® Insulation • White TFE Teflon Tape-wrapped Jacket

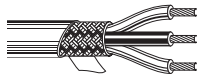
600V RMS -65°C to 200°C VW-1 	83303E	—	1	White	500 ^{††}	152.4	3.5	1.6	.010	.25	.010	.25	.076	1.93	—	—	44.6	146		
					1000 [▲]	304.8	6.0	2.7												
	83317E	—	2	White, Black	100 [†]	30.5	1.4	0.6	.010	.25	.011	.28	.121	3.07	20.8	68	35.5	116		
					500 ^{††}	152.4	6.5	3.0												
83332E	—	3	White, Black, Red	100 [†]	30.5	1.7	0.8	.010	.25	.011	.28	.127	3.23	18.8	62	31.4	103			
				1000 [▲]	304.8	17.0	7.7													
83347E	—	4	White, Black, Red, Green	100 [†]	30.5	1.9	0.9	.010	.25	.011	.28	.137	3.48	18.5	61	30.5	100			
				500 ^{††}	152.4	10.0	4.5													
				1000 [▲]	304.8	19.0	8.6													

MIL-Spec MIL-W-16878/4 (Type E).

24 AWG Stranded (19x36) Silver-plated Copper Conductors • Cabled and Color-coded • Silver-plated Copper Braid Shield (85% Coverage)

Extruded TFE Teflon Insulation • White TFE Teflon Tape-wrapped Jacket

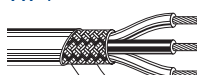
600V RMS -65°C to 200°C VW-1 	83304E	—	1	White	500 ^{††}	152.4	4.5	2.0	.010	.25	.010	.25	.085	2.16	—	—	46	151		
					1000 [▲]	304.8	8.0	3.6												
	83318E	—	2	White, Black	100 [†]	30.5	1.6	0.7	.010	.25	.011	.28	.131	3.33	26.5	87	42.4	139		
					500 ^{††}	152.4	7.5	3.4												
83333E	—	3	White, Black, Red	100 [†]	30.5	1.9	0.9	.010	.25	.011	.28	.137	3.48	21.9	72	36.8	121			
				500 ^{††}	304.8	10.0	4.5													
83348E	—	4	White, Black, Red, Green	100 [†]	30.5	2.3	1.0	.010	.25	.011	.28	.149	3.79	21.9	72	36.8	121			
				500 ^{††}	152.4	12.0	5.4													
				1000 [▲]	304.8	23.0	10.4													

Complies with MIL-W-16878/4 (Type E) except stranding.

22 AWG Stranded (19x34) Silver-plated Copper Conductors • Cabled and Color-coded • Silver-plated Copper Braid Shield (85% Coverage)

Extruded TFE Teflon Insulation • White TFE Teflon Tape-wrapped Jacket

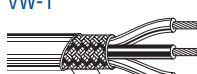
600V RMS -65°C to 200°C VW-1 	83305E	—	1	White	100 [†]	30.5	1.1	0.5	.010	.25	.010	.25	.091	2.31	—	—	57.9	190		
					500 ^{††}	152.4	5.0	2.3												
	83319E	—	2	White, Black	100 [†]	30.5	1.9	0.9	.010	.25	.011	.28	.143	3.63	29.9	98	49.2	161		
					500 ^{††}	152.4	10.0	4.5												
83334E	—	3	White, Black, Red	100 [†]	30.5	2.7	1.2	.010	.25	.011	.28	.150	3.81	27.4	90	45.7	150			
				500 ^{††}	152.4	12.5	5.7													
83349E	—	4	White, Black, Red, Green	100 [†]	30.5	3.1	1.4	.010	.25	.011	.28	.163	4.14	27.4	90	45.7	150			
				500 ^{††}	152.4	14.5	6.6													
				1000 [▲]	304.8	28.0	12.7													

Complies with MIL-W-16878/4 (Type E) except stranding.

*Capacitance between conductors.
**Capacitance between one conductor and other conductors connected to shield.

[†] 100 ft. put-up one piece, exact length.
^{††} 500 ft. put-up exact, but may contain up to 3 pieces. Minimum length of any one piece is 25 ft.
[▲] Spools may contain more than one piece. Length may vary ±10% from length shown.

Teflon is a DuPont trademark.



High-Temperature

Overall Braid Shield — Control and Instrumentation Cables

MIL-W-16878/4 (Type E) — Individual Conductors

Description	Part No.	UL NEC/ C(UL) CEC Type	No. of Cond.	Color Code	Standard Lengths		Standard Unit Weight		Insulation Thickness		Jacket Thickness		Nominal OD		Nominal Capacitance			
					Ft.	m	Lbs.	kg	Inch	mm	Inch	mm	Inch	mm	* pF/ Ft.	* pF/ m	** pF/ Ft.	** pF/ m

20 AWG Stranded (19x32) Silver-plated Copper Conductors • Cabled and Color-coded • Silver-plated Copper Braid Shield (85% Coverage)

Extruded TFE Teflon® Insulation • White TFE Teflon Tape-wrapped Jacket

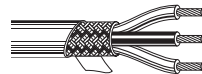
600V RMS -65°C to 200°C VW-1 	83306E	—	1	White	100 [†] 1000 [▲]	30.5 304.8	1.4 14.0	0.6 6.4	.010 .25	.010 .25	.099 2.52	—	—	69	226
	83320E	—	2	White, Black	100 [†] 500 ^{††} 1000 [▲]	30.5 152.4 304.8	2.6 12.0 23.0	1.2 5.4 10.4	.010 .25	.011 .28	.159 4.04	31.7 104	51	167	
	83335E	—	3	White, Black, Red	100 [†] 500 ^{††} 1000 [▲]	30.5 152.4 304.8	3.3 15.5 30.0	1.5 7.0 13.6	.010 .25	.011 .28	.168 4.27	31.7 104	51	167	
	83350E	—	4	White, Black, Red, Green	100 [†] 500 ^{††} 1000 [▲]	30.5 152.4 304.8	4.0 19.0 37.0	1.8 8.6 16.8	.010 .25	.011 .28	.183 4.65	31.7 104	51	167	

Complies with MIL-W-16878/4 (Type E) except stranding.

18 AWG Stranded (19x30) Silver-plated Copper Conductors • Cabled and Color-coded • Silver-plated Copper Braid Shield (85% Coverage)

Extruded TFE Teflon Insulation • White TFE Teflon Tape-wrapped Jacket

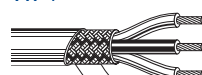
600V RMS -65°C to 200°C VW-1 	83307E	—	1	White	1000 [▲]	304.8	17.0	7.7	.011 .28	.010 .25	.109 2.77	—	—	71.5	235
	83321E	—	2	White, Black	100 [†] 500 ^{††} 1000 [▲]	30.5 152.4 304.8	3.2 15.0 29.0	1.5 6.8 13.2	.011 .28	.011 .28	.179 4.55	31	102	52.8	173
	83336E	—	3	White, Black, Red	100 [†] 500 ^{††} 1000 [▲]	30.5 152.4 304.8	4.2 20.0 39.0	1.9 9.1 17.7	.011 .28	.011 .28	.189 4.80	31	102	52.8	173
	83351E	—	4	White, Black, Red, Green	100 [†] 500 ^{††} 1000 [▲]	30.5 152.4 304.8	5.2 25.0 51.0	2.4 11.3 23.1	.011 .28	.011 .28	.207 5.26	31	102	52.8	173

Complies with MIL-W-16878/4 (Type E) except stranding.

16 AWG Stranded (19x29) Silver-plated Copper Conductors • Cabled and Color-coded • Silver-plated Copper Braid Shield (85% Coverage)

Extruded TFE Teflon Insulation • White TFE Teflon Tape-wrapped Jacket

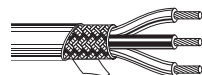
600V RMS -65°C to 200°C VW-1 	83308E	—	1	White	500 ^{††} 1000 [▲]	152.4 304.8	9.5 20.0	4.3 9.1	.012 .31	.011 .28	.120 3.05	—	—	72.5	238
	83322E	—	2	White, Black	100 [†] 500 ^{††} 1000 [▲]	30.5 152.4 304.8	3.8 18.0 35.0	1.7 8.2 15.9	.012 .31	.011 .28	.197 5.00	36	118	60	197
	83337E	—	3	White, Black, Red	100 [†] 500 ^{††} 1000 [▲]	30.5 152.4 304.8	5.0 24.5 49.0	2.3 11.1 22.2	.012 .31	.011 .28	.209 5.31	30.7 101	53	174	
	83352E	—	4	White, Black, Red, Green	100 [†] 500 ^{††} 1000 [▲]	30.5 152.4 304.8	6.2 30.5 61.0	2.8 13.8 27.7	.012 .31	.011 .28	.229 5.82	30.2 99	50.8	167	

Complies with MIL-W-16878/4 (Type E) except stranding.

*Capacitance between conductors.

**Capacitance between one conductor and other conductors connected to shield.

[†]100 ft. put-up one piece, exact length.

^{††}500 ft. put-up exact, but may contain up to 2 pieces. Minimum length of any one piece is 25 ft.

[▲]1000 ft. put-up exact, but may contain up to 6 pieces. Minimum length of any one piece is 25 ft.

Teflon is a DuPont trademark.



Fire Alarm

Power-Limited Fire Protective Signaling Circuit Cables

Subject 1424 (NEC Article 760, Type FPLR)

Description	Part No.	UL NEC/ C(UL) CEC Type	No. of Cond.	Color Code	Standard Lengths		Standard Unit Weight		Insulation Thickness		Jacket Thickness		Nominal OD	
					Ft.	m	Lbs.	kg	Inch	mm	Inch	mm	Inch	mm

22 AWG Solid Tinned Copper Conductors • Conductors Cabled

PVC Insulation • Black PVC Jacket

UL AWM Style 2464 & 1424 (300V 105°C)	9576	NEC: MPR, FPLR CEC: FAS 105 FT4	6	See Chart 1 (Tech Info Section)	U-500	U-152.4	18.0	8.2	.013	.33	.039	.99	.234	5.94
					U-1000	U-304.8	35.0	15.9						

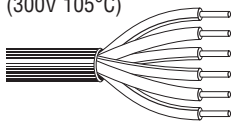

18 AWG Solid Bare Copper Conductors • Conductors Cabled

PVC Insulation • Red PVC Jacket

UL AWM Style 2464 & 1424 (300V 105°C)	9571	NEC: MPR, FPLR CEC: FAS 105 FT4	2	Black, Red	U-500	U-152.4	14.5	6.6	.017	.43	.037	.94	.228	5.79
					U-1000	U-304.8	28.0	12.7						



18 AWG Solid Bare Copper Conductors • Conductors Cabled • Overall Beldfoil® Shield (100% Coverage) • 22 AWG Stranded TC Drain Wire

PVC Insulation • Red PVC Jacket

UL AWM Style 2464 & 1424 (300V 105°C)	9574	NEC: MPR, FPLR CEC: FAS 105 FT4	2	Black, Red	U-500	U-152.4	16.0	7.3	.017	.43	.037	.94	.231	5.87
					U-1000	U-304.8	31.0	14.1						



UL AWM Style 2464 & 1424 (300V 105°C)	9578	NEC: MPR, FPLR CEC: FAS 105 FT4	4	Black, Red, Yellow, Light Blue	U-500	U-152.4	25.5	11.6	.017	.43	.037	.94	.263	6.68
					1000	304.8	51.0	23.2						

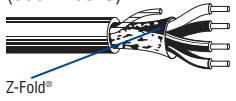

16 AWG Solid Bare Copper Conductors • Conductors Cabled

PVC Insulation • Red PVC Jacket

UL AWM Style 2464 & 1424 (300V 105°C)	9572	NEC: MPR, FPLR CEC: FAS 105 FT4	2	Black, Red	U-500	U-152.4	18.0	8.2	.018	.46	.037	.94	.250	6.35
					U-1000	U-304.8	35.0	15.9						



16 AWG Solid Bare Copper Conductors • Conductors Cabled • Overall Beldfoil® Shield (100% Coverage) • 22 AWG Stranded TC Drain Wire

PVC Insulation • Red PVC Jacket

UL AWM Style 2464 & 1424 (300V 105°C)	9575	NEC: MPR, FPLR CEC: FAS 105 FT4	2	Black, Red	U-500	U-152.4	20.0	9.1	.018	.46	.037	.94	.253	6.43
					U-1000	U-304.8	39.0	17.7						



UL AWM Style 2464 & 1424 (300V 105°C)	9579	NEC: MPR, FPLR CEC: FAS 105 FT4	4	Black, Red, Yellow, Light Blue	U-500	U-152.4	35.5	16.1	.018	.46	.042	1.07	.301	7.65
					1000	304.8	72.0	32.7						

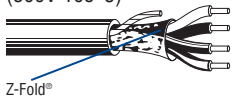

TC = Tinned Copper

All cables on this page pass the IEEE 383-2003 Flame Test and are listed by the California State Fire Marshall. Component Recognized UL2464.

Fire Alarm

Power-Limited Fire Protective Signaling Circuit Cables

Subject 1424 (NEC Article 760, Type FPLR)

Description	Part No.	UL NEC/ C(UL) CEC Type	No. of Cond.	Color Code	Standard Lengths		Standard Unit Weight		Insulation Thickness		Jacket Thickness		Nominal OD	
					Ft.	m	Lbs.	kg	Inch	mm	Inch	mm	Inch	mm

14 AWG Solid Bare Copper Conductors • Conductors Cabled

PVC Insulation • Red PVC Jacket														
UL Style 1424 (300V 105°C) 	9580	NEC: FPLR CEC: FAS 105 FT4	2	Black, Red	U-500	U-152.4	27.0	12.3	.022	.56	.042	1.07	.303	7.70
					1000	304.8	54.0	24.5						

14 AWG Solid Bare Copper Conductors • Conductors Cabled • Beldfoil® Shield (100% Coverage)

PVC Insulation • Red PVC Jacket														
UL Style 1424 (300V 105°C) 	9581	NEC: FPLR CEC: FAS 105 FT4	2	Black, Red	U-500	U-152.4	32.5	14.7	.022	.56	.042	1.07	.306	7.77
					1000	304.8	65.0	29.5						

12 AWG Solid Bare Copper Conductors • Conductors Cabled

PVC Insulation • Red PVC Jacket														
UL Style 1424 (300V 105°C) 	9582	NEC: FPLR CEC: FAS 105 FT4	2	Black, Red	1000	304.8	75.0	34.1	.022	.56	.042	1.07	.340	8.64

12 AWG Solid Bare Copper Conductors • Conductors Cabled • Beldfoil Shield (100% Coverage)

PVC Insulation • Red PVC Jacket														
UL Style 1424 (300V 105°C) 	9583	NEC: FPLR CEC: FAS 105 FT4	2	Black, Red	1000	304.8	85.0	38.6	.022	.56	.042	1.07	.343	8.71

All cables on this page pass the IEEE 383-2003 Flame Test and are listed by the California State Fire Marshall. Component Recognized UL2464, 300V 80°C.

4 • Multi-Conductor Cables

Plenum-Rated Fire Alarm

Power-Limited Fire Protective, Control and Instrumentation Cables

Subject 1424 (NEC Article 760, Type FPLP)

Description	Part No.	UL NEC/ C(UL) CEC Type	No. of Cond.	Color Code	Standard Lengths		Standard Unit Weight		Insulation Thickness		Jacket Thickness		Nominal OD		Nominal Capacitance			
					Ft.	m	Lbs.	kg	Inch	mm	Inch	mm	Inch	mm	* pF/ Ft.	* pF/ m	** pF/ Ft.	** pF/ m

14 AWG Stranded (7x22) TC Conductors • Conductors Cabled • Overall Beldfoil® (100% Coverage) + TC Braid Shield (85% Coverage)

Plenum • FEP Insulation • Red FEP Jacket

	83752 UL Style 2464 & 1424 (300V 200°C)	NEC: FPLP, CMP CEC: CMP FT6	2 See Chart 2 (Tech Info Section)	100 500† 1000†	30.5 152.4 304.8	7.1 31.5 60.0	3.2 14.3 27.2	.016 	.41 	.015 	.38 	.267 	6.78 	30 	98 	52 	171
		NEC: FPLP, CMP CEC: CMP FT6	3 See Chart 2 (Tech Info Section)	500† 1000†	152.4 304.8	42.5 82.0	19.3 37.2	.016 	.41 	.015 	.38 	.284 	7.21 	30 	98 	52 	171
		NEC: FPLP, CMP CEC: CMP FT6	4 See Chart 2 (Tech Info Section)	100 500† 1000†	30.5 152.4 304.8	9.8 52.5 102.0	4.5 23.8 46.3	.016 	.41 	.015 	.38 	.311 	7.90 	30 	98 	52 	171
		NEC: FPLP, CMP CEC: CMP FT6	6 See Chart 2 (Tech Info Section)	100 500† 1000†	30.5 152.4 304.8	14.1 74.5 150.0	6.4 34.0 68.1	.016 	.41 	.017 	.43 	.376 	9.55 	30 	98 	52 	171

12 AWG Stranded (7x20) TC Conductors • Conductors Cabled • Overall Beldfoil (100% Coverage) + TC Braid Shield (85% Coverage)

Plenum • FEP Insulation • Red FEP Jacket

	83802 UL Style 2464 & 1424 (300V 200°C)	NEC: FPLP, CMP CEC: CMP FT6	2 See Chart 2 (Tech Info Section)	100 500† 1000†	30.5 152.4 304.8	7.5 41.0 80.0	3.4 18.6 36.3	.016 	.41 	.015 	.38 	.303 	7.70 	32 	105 	55 	180
		NEC: FPLP, CMP CEC: CMP FT6	3 See Chart 2 (Tech Info Section)	100 500† 1000†	30.5 152.4 304.8	10.6 56.5 111.0	4.8 25.7 50.4	.016 	.41 	.015 	.38 	.323 	8.20 	32 	105 	55 	180
		NEC: FPLP, CMP CEC: CMP FT6	4 See Chart 2 (Tech Info Section)	100 500† 1000†	30.5 152.4 304.8	13.8 73.0 147.0	6.3 33.1 66.7	.016 	.41 	.017 	.43 	.359 	9.12 	32 	105 	55 	180
		NEC: FPLP, CMP CEC: CMP FT6	6 See Chart 2 (Tech Info Section)	100 500† 1000†	30.5 152.4 304.8	19.7 213.0 96.7	9.0 96.7	.016 	.41 	.017 	.43 	.430 	10.92 	32 	105 	55 	180

TC = Tinned Copper

All cables on this page pass the IEEE 383-2003 Flame Test and are listed by the California State Fire Marshall. Component Recognized UL2464, 300V 80°C.

*Capacitance between conductors.

**Capacitance between one conductor and other conductors connected to shield.

† Spools are one piece, but length may vary ±10% from length shown.



Paired Cables

Table of Contents

Paired Cables	Page No.
Introduction	5.2
Selection Guide: Shielded Multi-pair Computer Cables	5.3
Unshielded	5.4–5.9
Telephone Cables	5.4
Audio, Control and Instrumentation Cables	5.4
Overall Beldfoil® Shield	5.10–5.22
Cable Characteristics: Attenuation, Rise Time, Bit Rate	5.10
High-Temperature Control and Instrumentation Cables	5.11
Computer Cables	5.11
Low-Capacitance Computer Cables	5.14
Audio, Control and Instrumentation Cables	5.16
Combination Unshielded and Braid Shield	5.23
Audio, Control and Instrumentation Cables	5.23
Overall Braid Shield	5.23
Audio, Control and Instrumentation Cables	5.23
Overall Spiral Shield	5.24
Audio, Control and Instrumentation Cables	5.24
Overall Foil/Braid Shield	5.25–5.33
Cable Characteristics: Attenuation, Rise Time, Bit Rate	5.25
Low-Capacitance Computer Cables	5.26
Computer P.O.S. Cables	5.33
Individually Shielded	5.34–5.42
Cable Characteristics: Attenuation, Rise Time, Bit Rate	5.34
Low-Capacitance Computer Cables	5.35
Audio, Control and Instrumentation Cables	5.37
Cable Characteristics: Attenuation, Rise Time, Bit Rate	5.39
Audio, Control and Instrumentation Cables	5.40
Individually Shielded Pairs with Overall Foil/Braid Shield	5.43–5.47
Cable Characteristics: Attenuation, Rise Time, Bit Rate	5.43
Low-Capacitance Computer Cables	5.44
Special Audio, Communication and Instrumentation Cables	5.46
Plenum-Rated Cable	5.48–5.54
Unshielded: Audio, Control and Instrumentation Cables	5.48
Overall Beldfoil Shield: Computer Cables	5.49
Overall Beldfoil Shield: Low-Capacitance Computer Cables	5.50
Overall Beldfoil Shield: Audio, Control and Instrumentation Cables	5.51
Overall Foil/Braid Shield: Computer P.O.S. Cables	5.52
Overall Foil/Braid Shield: Low-Capacitance Computer Cables	5.52
Individually Shielded Pairs: Low-Capacitance Computer Cables	5.53
Individually Shielded Pairs: Audio, Control and Instrumentation	5.54

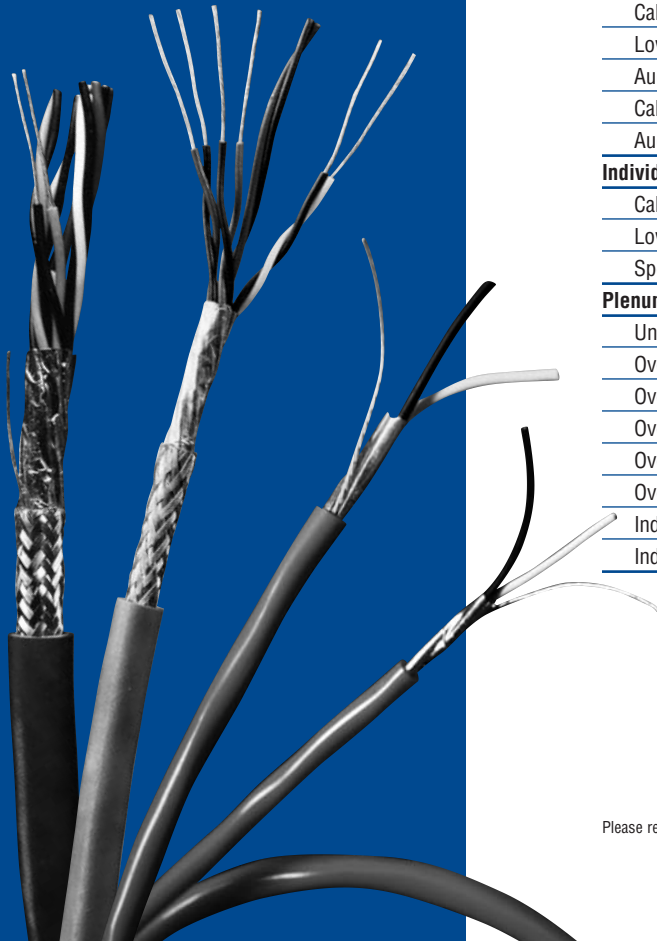

Introduction

Belden® paired cable products are manufactured in a variety of gage sizes, dimensions, insulation materials, shielding configurations, and jacketing materials including Plenum and High-Temperature versions to meet the technical requirements of many different types of systems.

Paired cables allow balanced signal transmission, which results in lower crosstalk through common mode rejection. Due to the improved noise immunity of twisted pairs, they generally permit higher data speeds than multi-conductor cables.

As an aid to proper cable selection, both the suggested working voltages and the maximum temperature ratings are indicated for each applicable paired cable selection.

Most of our paired cables are available from stock. Many of these are available off the shelf from distributors. If you have a new or unusual application or you cannot find a paired cable in this catalog section that meets your technical requirements, contact Technical Support at 1-800-BELDEN-1.

Paired Cables Packaging

Belden's unique UnReel® cable dispenser is available for many of the paired cable products listed in this section. The letter "U" before the specified put-up length denotes UnReel packaging.

Selection Guide

Shielded Multi-Pair Computer Cables
RS-232, RS-422, and RS-485 Applications*

Specifications		Cable Series**																	
		9804	8132	9829	8332	9501	8102	9729	8162	9990	9841	9680	9302*	8302	8777	9873	9773	8132FO	1419A
Conductor Size: (AWG)	28	✓	✓															✓	
	24			✓	✓	✓	✓	✓	✓	✓	✓								✓
	22											✓	✓	✓					
	20															✓			
	18																✓		
Page No.		5.26	5.27	5.30	5.29	5.11	5.31	5.35	5.44	5.37	5.28	5.15	5.17	5.32	5.40	5.42	5.42	5.14	5.15
Insulation:	S-R PVC				✓	✓							✓						
	Polyethylene			✓						✓	✓	✓				✓	✓		
	Polypropylene	✓													✓				
	Datalene®†		✓				✓	✓	✓									✓	✓
Shield:	Overall Foil					✓						✓	✓					✓	✓
	Individual Foil							✓	✓	✓				✓	✓	✓			
	Overall Foil/Braid	✓	✓	✓	✓		✓		✓		✓			✓					
	Braid Coverage	90%	65%	65%	65%		65%		65%		90%			65%					
Drain Wire: (see key below)		●	●	●	×	●	●	▲	▲	▲	●	●	●	×	▲	▲	▲	●	●
No. of Pairs Available:	1					✓					✓								
	2	✓	✓	✓	✓	✓	✓	✓	✓		✓		✓	✓				✓	✓
	3	✓	✓	✓	✓	✓	✓	✓	✓	✓	✓	✓	✓	✓	✓	✓	✓	✓	✓
	4	✓	✓	✓	✓	✓	✓	✓	✓		✓	✓	✓	✓				✓	✓
	5	✓	✓	✓	✓	✓	✓		✓				✓					✓	✓
	6			✓	✓	✓	✓	✓	✓	✓		✓	✓	✓	✓	✓	✓		✓
	7	✓		✓	✓	✓	✓		✓				✓						
	8		✓			✓	✓		✓				✓						✓
	9	✓		✓		✓		✓		✓		✓	✓		✓	✓	✓		
	10			✓	✓	✓	✓		✓				✓						
	11							✓							✓	✓			
	12	✓		✓				✓		✓					✓	✓	✓		
	12.5		✓		✓		✓					✓		✓				✓	✓
	13	✓																	
	15				✓	✓	✓	✓	✓				✓	✓	✓	✓	✓		✓
	17							✓							✓				
	18	✓	✓	✓	✓		✓		✓				✓					✓	
	19					✓		✓					✓		✓				
	25	✓	✓	✓	✓	✓	✓		✓	✓			✓					✓	
	27							✓					✓		✓				
31	✓																		
37														✓					
50					✓														
Capacitance †† (pF/ft.)		15.5	11.0	15.5	30.0	30.0	12.5	12.5	12.5	25.0	12.8	15.5	35.0	35.0	30.0	30.0	30.0	11.0	13.0

S-R = Semi-rigid

* Refer to specifications for recommendations.
 ** All cables are UL-listed.
 † Foam high density polyethylene.
 †† Capacitance may vary on some cables.
 ♦ Standard PVC Insulation, solid conductors.

Drain Wire Key:
 ● = Drain wire overall.
 ▲ = Drain wire each pair.
 × = No drain wire.



Unshielded

Telephone Cables

Audio, Control and Instrumentation Cables

Description	Part No.	UL NEC/ C(UL) CEC Type	No. of Pairs	Color Code	Standard Lengths		Standard Unit Weight		Insulation Thickness		Jacket Thickness		Nominal OD	
					Ft.	m	Lbs.	kg	Inch	mm	Inch	mm	Inch	mm

24 AWG Solid Tinned Copper Conductors • Twisted Pairs

PVC Insulation • Chrome PVC Jacket															
	UL AWM Style 2576 (150V 80°C)	9562	NEC:	2	See Chart 4 (Tech Info Section)	U-500	U-152.4	10.5	4.8	.010	.25	.032	.81	.199	5.05
			CMG			500	152.4	9.0	4.1						
			CEC:			U-1000	U-304.8	20.0	9.1						
			CMG FT4			1000	304.8	18.0	8.2						
	9566	NEC:	6	See Chart 4 (Tech Info Section)	U-500	U-152.4	21.5	9.8	.010	.25	.032	.81	.289	7.34	
		CMG			500	152.4	23.5	10.7							
		CEC:			U-1000	U-304.8	42.0	19.1							
		CMG FT4			1000	304.8	45.0	20.5							
	9570	NEC:	10	See Chart 4 (Tech Info Section)	500	152.4	31.5	14.3	.010	.25	.035	.89	.310	7.87	
		CMG			1000	304.8	63.0	28.6							
		CEC:													
		CMG FT4													
9585	NEC:	25	See Chart 4 (Tech Info Section)	500	152.4	74.0	33.6	.010	.25	.040	1.02	.480	12.19		
	CMG			1000	304.8	144.0	65.5								
	CEC:														
	CMG FT4														

22 AWG Solid Tinned Copper Conductors • Twisted Pairs

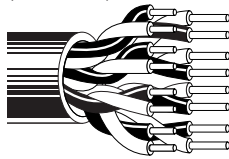
PVC Insulation • Chrome PVC Jacket															
	UL AWM Style 2576 (150V 80°C)	8740	NEC:	1	See Chart 3 (Tech Info Section)	U-500	U-152.4	7.5	3.4	.010	.25	.032	.81	.156	3.96
			CMG			U-1000	U-304.8	14.0	6.4						
			CEC:												
			CMG FT4												
	8741	NEC:	2	See Chart 3 (Tech Info Section)	U-500	U-152.4	13.5	6.1	.010	.25	.032	.81	.230	5.84	
		MPG, CMG			U-1000	U-304.8	25.0	11.3							
		CEC:			1000	304.8	27.0	12.2							
		CMG FT4													
	8742	NEC:	3	See Chart 3 (Tech Info Section)	500	152.4	17.0	7.7	.010	.25	.032	.81	.242	6.15	
		MPG, CMG			U-1000	U-304.8	31.0	14.1							
		CEC:			1000	304.8	33.0	15.0							
		CMG FT4													
8757	NEC:	4	See Chart 3 (Tech Info Section)	500	152.4	20.0	9.1	.010	.25	.032	.81	.264	6.71		
	MPG, CMG			U-1000	U-304.8	38.0	17.2								
	CEC:			1000	304.8	40.0	18.2								
	CMG FT4														
8743	NEC:	6	See Chart 3 (Tech Info Section)	U-500	U-152.4	26.5	12.0	.010	.25	.032	.81	.293	7.44		
	MPG, CMG			U-1000	U-304.8	51.0	23.1								
	CEC:			1000	304.8	53.0	24.1								
	CMG FT4														
9160	NEC:	8	See Chart 3 (Tech Info Section)	500	152.4	35.5	16.1	.010	.25	.035	.89	.323	8.20		
	MPG, CMG			1000	304.8	71.0	32.3								
	CEC:														
	CMG FT4														
8744	NEC:	9	See Chart 3 (Tech Info Section)	1000	304.8	79.0	35.9	.010	.25	.035	.89	.350	8.89		
	MPG, CMG														
	CEC:														
	CMG FT4														

Unshielded

Audio, Control and Instrumentation Cables

Description	Part No.	UL NEC/ C(UL) CEC Type	No. of Pairs	Color Code	Standard Lengths		Standard Unit Weight		Insulation Thickness		Jacket Thickness		Nominal OD		
					Ft.	m	Lbs.	kg	Inch	mm	Inch	mm	Inch	mm	
22 AWG Stranded (7x30) Tinned Copper Conductors • Twisted Pairs															
PVC Insulation • Chrome PVC Jacket															
	9744	NEC:	2	See Chart 3 (Tech Info Section)	U-500	U-152.4	13.5	6.1	.010	.25	.032	.81	.244	6.20	
		CMG			500	152.4	14.0	6.4							
		CEC:			U-1000	U-304.8	26.0	11.8							
			CMG FT4			1000	304.8	27.0	12.3						
		9745	NEC:	3	See Chart 3 (Tech Info Section)	U-500	U-152.4	18.0	8.2	.010	.25	.032	.81	.257	6.53
	CMG		500			152.4	18.0	8.2							
	CEC:		U-1000			U-304.8	34.0	15.4							
			CMG FT4			1000	304.8	36.0	16.4						
		9746	NEC:	4	See Chart 3 (Tech Info Section)	500	152.4	22.5	10.2	.010	.25	.032	.81	.281	7.14
	CMG		1000			304.8	42.0	19.1							
	CEC:														
			CMG FT4												
	8747	NEC:	6	See Chart 3 (Tech Info Section)	100	30.5	6.2	2.8	.010	.25	.035	.89	.320	8.13	
CMG		500			152.4	30.0	13.6								
CEC:		1000			304.8	59.0	26.8								
		CMG FT4													
	8748	NEC:	9	See Chart 3 (Tech Info Section)	100	30.5	8.6	3.9	.010	.25	.037	.94	.389	9.88	
CMG		500			152.4	43.5	19.8								
CEC:		1000			304.8	84.0	38.2								
		CMG FT4													
	9747	NEC:	12	See Chart 3 (Tech Info Section)	100	30.5	11.5	5.2	.010	.25	.040	1.02	.425	10.80	
CMG		500			152.4	55.0	25.0								
CEC:		1000			304.8	109.0	49.5								
		CMG FT4													
	8749	NEC:	15	See Chart 3 (Tech Info Section)	500	152.4	64.0	29.1	.010	.25	.040	1.02	.440	11.18	
CMG		1000			304.8	124.0	56.4								
CEC:															
		CMG FT4													
	9748	NEC:	19	See Chart 3 (Tech Info Section)	500	152.4	81.5	37.0	.010	.25	.040	1.02	.505	12.83	
CMG		1000			304.8	159.0	72.3								
CEC:															
		CMG FT4													
	8750	NEC:	27	See Chart 3 (Tech Info Section)	1000 [†]	304.8	221.0	100.5	.010	.25	.045	1.14	.575	14.61	
CMG															
CEC:															
		CMG FT4													

[†]Spools are one piece, but length may vary -0% to +20% from length shown.

Unshielded

Audio, Control and Instrumentation Cables
Plenum-Rated

Description	Part No.	UL NEC/ C(UL) CEC Type	No. of Pairs	Color Code	Standard Lengths		Standard Unit Weight		Insulation Thickness		Jacket Thickness		Nominal OD	
					Ft.	m	Lbs.	kg	Inch	mm	Inch	mm	Inch	mm

22 AWG Stranded (7x30) Tinned Copper Conductors • Twisted Pairs

Plenum • FEP Insulation • Red FEP Jacket

	88442 NEC: CMP CEC: CMP FT6	1 Black & Red	100 500 [†] 1000 [†]	30.5 152.4 304.8	2.3 5.5 8.0	1.0 2.5 3.6	.006 .006 .006	.15 .15 .15	.012 .012 .019	.30 .30 .23	.102 .169 .200	2.59 4.29 5.08					
													2 Black & Red, Black & White	500 [†] 1000 [†]	152.4 304.8	8.0 16.0	3.6 7.3
													4 Black & Red, Black & White, Black & Green, Black & Blue	500 [†] 1000 [†]	152.4 304.8	14.0 28.0	6.4 12.7
													2 Black & Red, Black & White	500 [†] 1000 [†]	152.4 304.8	8.0 16.0	3.6 7.3

Plenum • FEP Insulation • Natural Flamarrest® Jacket

	82442 NEC: CMP CEC: CMP FT6	1 Black & Red	U-1000 [†] 1000 [†]	U-304.8 304.8	9.0 8.0	4.1 3.6	.006 .006	.15 .15	.014 .014	.36 .36	.112 .179	2.84 4.55					
													2 Black & Red, Black & White	U-1000 [†] 1000 [†]	U-304.8 304.8	18.0 20.0	8.2 9.1
													3 Black & Red, Black & White, Black & Green	U-1000 [†] 1000 [†]	U-304.8 304.8	24.0 26.0	10.9 11.8
													4 Black & Red, Black & White, Black & Green, Black & Blue	1000 [†]	304.8	32.0	14.5
													6 Black & Red, Black & White, Black & Green, Black & Blue, Black & Yellow, Black & Brown	U-1000 [†] 1000 [†]	U-304.8 304.8	44.0 46.0	20.0 20.9



[†]Spools and/or UnReel® cartons are one piece, but length may vary ±10% for spools and ±5% for UnReel from length shown.

Unshielded

Audio, Control and Instrumentation Cables

Description	Part No.	UL NEC/ C(UL) CEC Type	No. of Pairs	Color Code	Standard Lengths		Standard Unit Weight		Insulation Thickness		Jacket Thickness		Nominal OD	
					Ft.	m	Lbs.	kg	Inch	mm	Inch	mm	Inch	mm

20 AWG Stranded (7x28) Tinned Copper Conductors • Twisted Pairs

PVC Insulation • Chrome PVC Jacket																
	8205	NEC:	1	See Chart 3 (Tech Info Section)	100	30.5	2.6	1.2	.013	.33	.025	.64	.180	4.57		
		CMG:			U-500	U-152.4	9.0	4.1								
		CEC:			500	152.4	9.0	4.1								
		CMG FT4			U-1000	U-304.8	18.0	8.2								
					1000	304.8	18.0	8.2								
	9750	NEC:	3	See Chart 3 (Tech Info Section)	500	152.4	26.5	12.0	.013	.33	.035	.89	.299	7.59		
		CMG:			1000	304.8	50.0	22.7								
		CEC:														
		CMG FT4														
	9751	NEC:	6	See Chart 3 (Tech Info Section)	100	30.5	9.1	4.1	.013	.33	.035	.89	.366	9.30		
		CMG:			500	152.4	45.0	20.5								
		CEC:			1000	304.8	89.0	40.5								
		CMG FT4														
	9752	NEC:	9	See Chart 3 (Tech Info Section)	100	30.5	13.1	5.9	.013	.33	.035	.89	.429	10.90		
		CMG:			500	152.4	65.5	29.8								
		CEC:			1000	304.8	125.0	56.8								
		CMG FT4														
9755	NEC:	15	See Chart 3 (Tech Info Section)	100	30.5	17.9	8.1	.013	.33	.040	1.02	.545	13.84			
	CMG:			1000	304.8	194.0	88.2									
	CEC:															
	CMG FT4															

19 AWG Solid Bare Copper Conductors • Twisted Pair

PVC Insulation • Chrome PVC Jacket														
	8486	NEC:	1	Brown, Tan	U-500	U-152.4	9.5	4.3	.015	.38	.025	.64	.182	4.62
		CM			U-1000	U-304.8	18.0	8.2						
		CEC:			1000	304.8	19.0	8.6						
		CM												

18 AWG Stranded (7x26) Tinned Copper Conductors • Twisted Pair

PVC Insulation • Chrome PVC Jacket														
	8461	NEC:	1	Black, White	100	30.5	3.2	1.4	.022	.56	.028	.71	.234	5.94
		CMG:			U-500	U-152.4	14.0	6.4						
		CEC:			500	152.4	13.5	6.1						
		CMG FT4			U-1000	U-304.8	26.0	11.8						
					1000	304.8	27.0	12.2						

Unshielded

Audio, Control and Instrumentation Cables

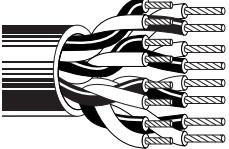
Description	Part No.	UL NEC/ C(UL) CEC Type	No. of Pairs	Color Code	Standard Lengths		Standard Unit Weight		Insulation Thickness		Jacket Thickness		Nominal OD		
					Ft.	m	Lbs.	kg	Inch	mm	Inch	mm	Inch	mm	
18 AWG Stranded (16x30) Tinned Copper Conductors • Twisted Pairs															
PVC Insulation • Chrome PVC Jacket															
	9740	NEC: CMG CEC: CMG FT4	1	See Chart 3 (Tech Info Section)	U-500 500	U-152.4 152.4	12.5 12.5	5.7 5.7	.014	.36	.032	.81	.210	5.33	
						U-1000 1000	U-304.8 304.8	24.0 24.0	10.9 10.9						For Plenum versions of 9740, see 89740, 87740 or 82740.
	9156	NEC: CMG CEC: CMG FT4	2	See Chart 3 (Tech Info Section)	U-500 500	U-152.4 152.4	25.0 27.0	11.3 12.2	.014	.36	.035	.89	.333	8.46	
						U-1000 1000	U-304.8 304.8	49.0 51.0	22.2 23.2						
	8690	NEC: CMG CEC: CMG FT4	3	See Chart 3 (Tech Info Section)	100 500	30.5 152.4	7.0 32.5	3.2 14.8	.014	.36	.032	.81	.347	8.81	
						1000 1000	304.8 304.8	65.0 29.5							
	9157	NEC: CMG CEC: CMG FT4	4	See Chart 3 (Tech Info Section)	100 500	30.5 152.4	8.4 41.0	3.8 18.6	.014	.36	.032	.81	.381	9.68	
						1000 1000	304.8 304.8	83.0 37.7							
	9159	NEC: CMG CEC: CMG FT4	5	See Chart 3 (Tech Info Section)	500 1000	152.4 304.8	50.0 99.0	22.7 45.0	.014	.36	.032	.81	.391	9.93	
	8691	NEC: CMG CEC: CMG FT4	6	See Chart 3 (Tech Info Section)	500 1000	152.4 304.8	58.0 115.0	26.4 52.3	.014	.36	.032	.81	.433	11.00	
	9161	NEC: CMG CEC: CMG FT4	8	See Chart 3 (Tech Info Section)	100 500	30.5 152.4	14.2 78.0	6.4 35.6	.014	.36	.037	.94	.485	12.32	
						1000 1000	304.8 304.8	152.0 69.3							
	8692	NEC: CMG CEC: CMG FT4	9	See Chart 3 (Tech Info Section)	500 1000	152.4 304.8	87.0 170.0	39.5 77.3	.014	.36	.040	1.02	.524	13.31	
	9741	NEC: CMG CEC: CMG FT4	12	See Chart 3 (Tech Info Section)	100 1000	30.5 304.8	25.4 220.0	11.5 99.8	.014	.36	.046	1.17	.600	15.24	
	9742	NEC: CMG CEC: CMG FT4	15	See Chart 3 (Tech Info Section)	100 500	30.5 152.4	30.9 146.5	14.0 66.5	.014	.36	.051	1.30	.677	17.20	
					1000 1000	304.8 304.8	291.0 132.0								
9743	NEC: CMG CEC: CMG FT4	19	See Chart 3 (Tech Info Section)	100 500	30.5 152.4	37.0 179.0	16.8 81.4	.014	.36	.055	1.40	.721	18.31		
					1000 1000	304.8 304.8	355.0 161.4								

Unshielded

Audio, Control and Instrumentation Cables
Plenum-Rated and Non-Plenum

Description	Part No.	UL NEC/ C(UL) CEC Type	No. of Pairs	Color Code	Standard Lengths		Standard Unit Weight		Insulation Thickness		Jacket Thickness		Nominal OD	
					Ft.	m	Lbs.	kg	Inch	mm	Inch	mm	Inch	mm

18 AWG Stranded (19x30) Tinned Copper Conductors • Twisted Pair

Plenum • FEP Insulation • Red FEP Jacket															
	300V RMS	89740	NEC:	1	Black, Red	100	30.5	3.0	1.4	.006	.17	.009	.23	.136	3.45
			CMP			500 [†]	152.4	9.0	4.1						
			CEC: CMP FT6			1000 [†]	304.8	15.0	6.8						

Plenum • FEP Insulation • Red Fluorocopolymer Jacket															
	300V RMS	87740	NEC:	1	Black, Red	500 [†]	152.4	9.0	4.1	.006	.17	.011	.28	.140	3.56
			CMP			1000 [†]	304.8	15.0	6.8						
			CEC: CMP FT6												

Plenum • FEP Insulation • Natural Flamarrest® Jacket															
	300V RMS	82740	NEC:	1	Black, Red	U-1000	U-304.8	17.0	7.7	.006	.17	.015	.38	.147	3.73
			CMP			1000 [†]	304.8	16.0	7.3						
			CEC: CMP FT6												

16 AWG Stranded (19x29) Tinned Copper Conductors • Twisted Pair

PVC Insulation • Chrome PVC Jacket															
	UL AWM Style 2598 (300V 60°C)	8471	NEC:	1	Black, White	U-500	U-152.4	21.0	9.5	.023	.58	.032	.81	.274	6.96
			CMG			500	152.4	20.0	9.1						
			CEC: CMG FT4			U-1000	U-304.8	41.0	18.6						
						1000	304.8	43.0	19.5						

14 AWG Stranded (42x30) Tinned Copper Conductors • Twisted Pair

PVC Insulation • Chrome PVC Jacket															
	UL AWM Style 2587 (600V 90°C)	8473	NEC:	1	Black, White	U-500	U-152.4	29.0	13.2	.031	.79	.032	.81	.340	8.64
			CL3			500	152.4	30.5	13.9						
			CEC: FAS 90 FT4			1000	304.8	58.0	26.4						

See NEC Guidelines for applicable CL3 voltage ratings.

12 AWG Stranded (65x30) Tinned Copper Conductors • Twisted Pair

PVC Insulation • Chrome PVC Jacket															
	UL AWM Style 2587 (600V 90°C)	8477	NEC:	1	Black, White	U-500	U-152.4	41.5	18.8	.032	.81	.035	.89	.386	9.80
			CL3R			500	152.4	43.5	19.7						
						1000	304.8	85.0	38.6						

See NEC Guidelines for applicable CL3 voltage ratings.

[†]Spools are one piece, but length may vary ±10% from length shown.

Overall Beldfoil® Shield

Cable Characteristics

Attenuation

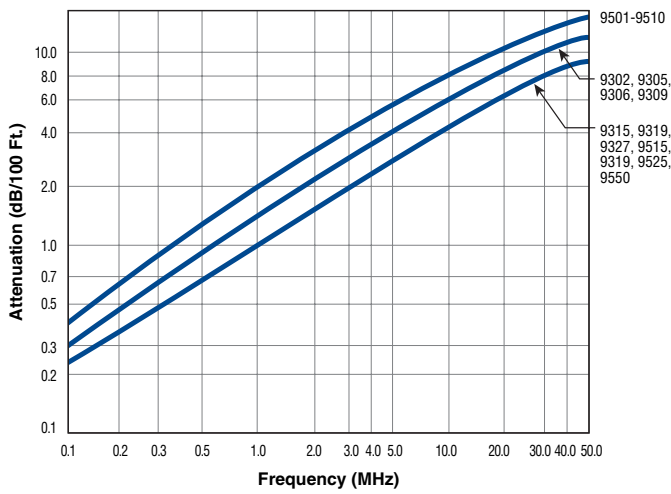

Rise Time

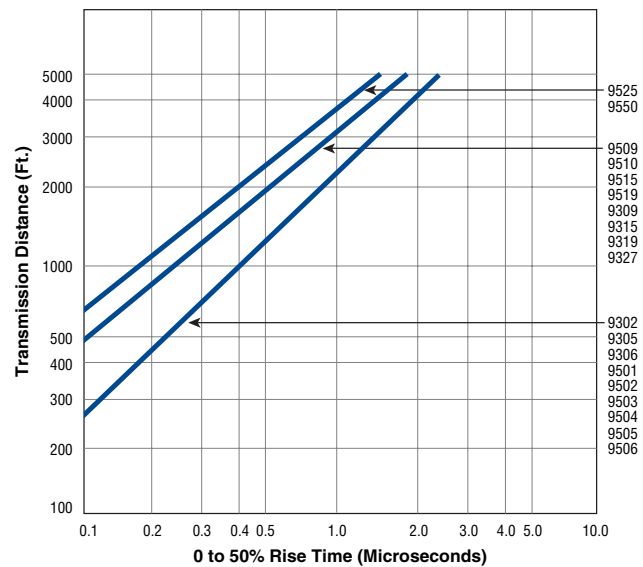

Bit Rate

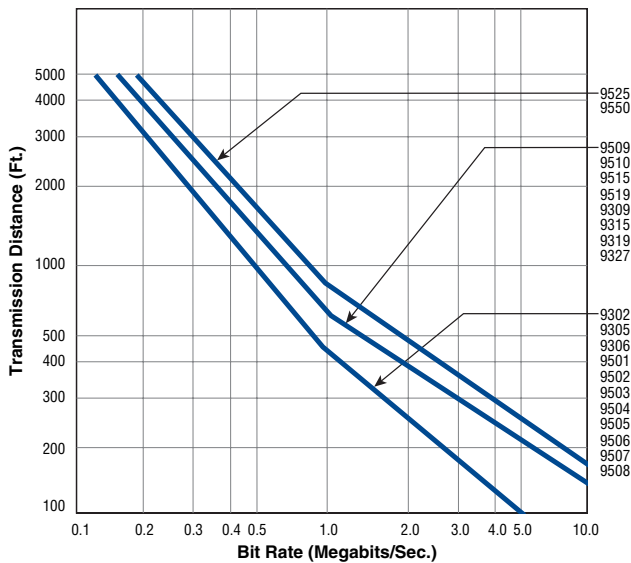

Cables are terminated in their characteristic impedance. Signal source electrical characteristics: 50 ohms and 10% to 90% rise time less than 5 nanoseconds.

Charts assume 5% peak-to-peak time jitter as determined by eye pattern measurements of pseudorandom NRZ code.

Overall Beldfoil® Shield

High-Temperature Control and Instrumentation Cables and Computer Cables for EIA RS-232 Applications

Description	Part No.	UL NEC/ C(UL) CEC Type	No. of Pairs	Color Code	Standard Lengths		Standard Unit Weight		Insulation Thickness		Jacket Thickness		Nominal OD		Nominal Capacitance			
					Ft.	m	Lbs.	kg	Inch	mm	Inch	mm	Inch	mm	* pF/ Ft.	* pF/ m	** pF/ Ft.	** pF/ m

20 AWG Stranded (7x28) TC Conductors • Pairs Cabled Together • Overall Beldfoil® Shield (100% Coverage) • Drain Wire

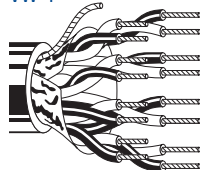
Tefzel® Insulation • Clear Tefzel Jacket																				
High-Temperature 300V RMS, 150°C VW-1	85164	4	See Chart 3 (Tech Info Section)	100	30.5	6.6	3.0	.015	.38	.025	.64	.344	8.74	23	75	40	131			
				500†	152.4	37.0	16.8													
				1000†	304.8	71.0	32.3													
	85168	8	See Chart 3 (Tech Info Section)	100	30.5	11.5	5.2	.015	.38	.025	.64	.439	11.15	23	75	40	131			
				500†	152.4	62.0	28.2													
				1000†	304.8	126.0	57.3													

Description	Part No.	UL NEC/ C(UL) CEC Type	No. of Pairs	Color Code	Standard Lengths		Standard Unit Weight		Nom. DCR		Nominal OD		Nom. Imp. (Ω)	Nom. Vel. of Prop.	Nom. Capacitance			
					Ft.	m	Lbs.	kg	Cond.	Shield	Inch	mm			* pF/ Ft.	* pF/ m	** pF/ Ft.	** pF/ m

24 AWG Stranded (7x32) TC Conductors • Twisted Pairs • Overall Beldfoil Shield (100% Coverage) • 24 AWG Stranded TC Drain Wire

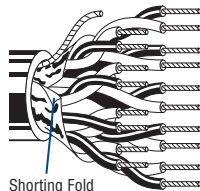
Semi-rigid PVC Insulation • Chrome PVC Jacket																				
UL AWM Style 2464 (300V 80°C) CSA AWM I A	9501	NEC: 1 CMG CEC: CMG FT4	See Chart 3 (Tech Info Section)	100	30.5	2.1	1.0	24.0Ω/M'	18.0Ω/M'	.156	3.96	75	60%	40	131	74	243			
				U-500	U-152.4	7.5	3.4	78.7Ω/km	59.1Ω/km											
				500	152.4	7.0	3.2													
				U-1000	U-304.8	14.0	6.4													
				1000	304.8	14.0	6.4													
 Shorting Fold	9502††	NEC: 2 CMG CEC: CMG FT4 P-MSHA-SC-7K-182037	See Chart 3 (Tech Info Section)	100	30.5	3.7	1.7	24.0Ω/M'	17.0Ω/M'	.222	5.64	75	60%	30	98	50	164			
				U-500	U-152.4	15.0	6.8	78.7Ω/km	55.8Ω/km											
				500	152.4	14.5	6.6													
				U-1000	U-304.8	28.0	12.7													
				1000	304.8	30.0	13.6													
				10000	3048.0	290.0	131.8													
	9503	NEC: 3 CMG CEC: CMG FT4	See Chart 3 (Tech Info Section)	100	30.5	3.4	1.5	24.0Ω/M'	17.0Ω/M'	.232	5.89	75	60%	30	98	50	164			
				U-500	U-152.4	15.0	6.8	78.7Ω/km	55.8Ω/km											
				500	152.4	14.5	6.6													
				U-1000	U-304.8	28.0	12.7													
				1000	304.8	30.0	13.6													
	9504	NEC: 4 CMG CEC: CMG FT4	See Chart 3 (Tech Info Section)	100	30.5	4.0	1.8	24.0Ω/M'	17.0Ω/M'	.265	6.73	75	60%	30	98	50	164			
				U-500	U-152.4	18.0	8.2	78.7Ω/km	55.8Ω/km											
				500	152.4	16.5	7.5													
				U-1000	U-304.8	35.0	15.9													
				1000	304.8	36.0	16.3													
	9505	NEC: 5 CMG CEC: CMG FT4	See Chart 3 (Tech Info Section)	100	30.5	4.7	2.1	24.0Ω/M'	17.0Ω/M'	.289	7.34	75	60%	30	98	50	164			
				U-500	U-152.4	21.5	9.8	78.7Ω/km	55.8Ω/km											
				500	152.4	23.0	10.4													
				U-1000	U-304.8	41.0	18.6													
				1000	304.8	43.0	19.5													

DCR = DC Resistance • TC = Tinned Copper

* Capacitance between conductors.

** Capacitance between one conductor and other conductors connected to shield.

† Spools are one piece, but length may vary ±10% from length shown.

†† Pennsylvania Department of Environmental Resources and United States Mine Safety and Health Administration certification. Request quotations of RG/U cables not listed.

See Attenuation, Rise Time and Bit Rate data for this series on page 5.10.

Tefzel is a DuPont trademark.



Overall Beldfoil® Shield

Computer Cables for EIA RS-232 Applications

Description	Part No.	UL NEC/ C(UL) CEC Type	No. of Pairs	Color Code	Standard Lengths		Standard Unit Weight		Nom. DCR		Nominal OD		Nom. Imp. (Ω)	Nom. Vel. of Prop.	Nom. Capacitance			
					Ft.	m	Lbs.	kg	Cond.	Shield	Inch	mm			* pF/ Ft.	* pF/ m	** pF/ Ft.	** pF/ m

24 AWG Stranded (7x32) TC Conductors • Twisted Pairs • Overall Beldfoil Shield (100% Coverage) • 24 AWG Stranded TC Drain Wire (continued)

Semi-rigid PVC Insulation • Chrome PVC Jacket

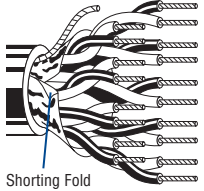
 <p>UL AWM Style 2464 (300V 80°C) CSA AWM I A</p> <p>Shorting Fold</p>	9506	NEC:	6	See Chart 3 (Tech Info Section)	100	30.5	5.0	2.3	24.0Ω/M'	16.0Ω/M'	.289	7.34	75	60%	30	98	50	164	
		CMG			U-500	U-152.4	23.0	10.4	78.7Ω/km	52.5Ω/km									
		CEC:			500	152.4	25.0	11.3											
		CMG FT4				U-1000	U-304.8	45.0	20.4			For Plenum version of 9506, see 82506.							
						1000	304.8	47.0	21.4										
		9507	NEC:	7	See Chart 3 (Tech Info Section)	100	30.5	5.5	2.5	24.0Ω/M'	16.5Ω/M'	.294	7.47	75	60%	30	98	50	164
	CMG		U-500			U-152.4	25.0	11.3	78.7Ω/km	54.1Ω/km									
	CEC:		500			152.4	27.0	12.3											
		CMG FT4				U-1000	U-304.8	49.0	22.2										
						1000	304.8	51.0	23.1										
	9508	NEC:	8	See Chart 3 (Tech Info Section)	100	30.5	6.3	2.9	24.0Ω/M'	16.5Ω/M'	.324	8.23	75	60%	30	98	50	164	
CMG		500			152.4	30.5	13.8	78.7Ω/km	54.1Ω/km										
CEC:		1000			304.8	60.0	27.2												
	CMG FT4																		
	9509	NEC:	9	See Chart 3 (Tech Info Section)	100	30.5	6.9	3.1	24.0Ω/M'	16.5Ω/M'	.334	8.48	75	60%	30	98	50	164	
CMG		500			152.4	33.5	15.2	78.7Ω/km	54.1Ω/km										
CEC:		1000			304.8	67.0	30.4												
	CMG FT4										For Plenum version of 9509, see 82509.								
	9510	NEC:	10	See Chart 3 (Tech Info Section)	100	30.5	7.5	3.4	24.0Ω/M'	16.5Ω/M'	.368	9.34	75	60%	30	98	50	164	
CMG		500			152.4	36.5	16.6	78.7Ω/km	54.1Ω/km										
CEC:		1000			304.8	74.0	33.6												
	CMG FT4																		
	9515	NEC:	15	See Chart 3 (Tech Info Section)	100	30.5	10.4	4.7	24.0Ω/M'	16.5Ω/M'	.417	10.6	75	60%	30	98	50	164	
CMG		500			152.4	52.0	23.6	78.7Ω/km	54.1Ω/km										
CEC:		1000			304.8	102.0	46.4												
	CMG FT4																		
	9519	NEC:	19	See Chart 3 (Tech Info Section)	100	30.5	12.8	5.8	24.0Ω/M'	16.5Ω/M'	.448	11.4	75	60%	30	98	50	164	
CMG		500			152.4	61.5	28.0	78.7Ω/km	54.1Ω/km										
CEC:		1000			304.8	122.0	55.5												
	CMG FT4																		
	9525	NEC:	25	See Chart 3 (Tech Info Section)	100	30.5	16.0	7.3	24.0Ω/M'	16.5Ω/M'	.503	12.8	75	60%	30	98	50	164	
CMG		500			152.4	79.5	36.1	78.7Ω/km	54.1Ω/km										
CEC:		1000			304.8	155.0	70.3												
	CMG FT4																		
	9550	NEC:	50	Request Technical Bulletin T/8-4	100	30.5	31.9	14.5	24.0Ω/M'	15.2Ω/M'	.708	18.0	75	60%	30	98	50	164	
CMG		500†			152.4	153.5	69.8	78.7Ω/km	49.9Ω/km										
CEC:		1000†			304.8	311.0	141.4												
	CMG FT4																		

DCR = DC Resistance • TC = Tinned Copper

*Capacitance between conductors.

**Capacitance between one conductor and other conductors connected to shield.

† Spools are one piece, but length may vary -0% to +20% from length shown.

See Attenuation, Rise Time and Bit Rate data for this series on page 5.10.

Overall Beldfoil® Shield

Computer Cables for EIA RS-232 Applications

Plenum-Rated

Description	Part No.	UL NEC/ C(UL) CEC Type	No. of Pairs	Color Code	Standard Lengths		Standard Unit Weight		Insulation Thickness		Jacket Thickness		Nominal OD		Nominal Capacitance			
					Ft.	m	Lbs.	kg	Inch	mm	Inch	mm	Inch	mm	* pF/ Ft.	* pF/ m	** pF/ Ft.	** pF/ m

24 AWG Stranded (7x32) TC Conductors • Twisted Pairs • Overall Beldfoil Shield (100% Coverage) • 24 AWG Stranded TC Drain Wire

Plenum • FEP Insulation • Natural Flamarrest® Jacket

	300V RMS	82641	NEC: CMP CEC: CMP FT6	1	See Chart 3 (Tech Info Section)	U-1000† 1000†	U-304.8 304.8	9.0 8.0	4.1 3.6	.006 .15	.15 .014	.36 .36	.106 2.69	31	102	59	194
		82502	NEC: CMP CEC: CMP FT6	2	See Chart 3 (Tech Info Section)	U-500† 1000†	U-152.4 U-304.8	8.0 16.0	3.6 7.3	.006 .15	.15 .014	.36 .36	.162 4.11	25	82	45	148
		82503	NEC: CMP CEC: CMP FT6	3	See Chart 3 (Tech Info Section)	U-1000† 1000†	U-304.8 304.8	19.0 18.0	8.6 8.2	.006 .15	.15 .014	.36 .36	.169 4.29	25	82	45	148
		82504	NEC: CMP CEC: CMP FT6	4	See Chart 3 (Tech Info Section)	U-1000† 1000†	U-304.8 304.8	24.0 26.0	10.9 11.8	.006 .15	.15 .014	.36 .36	.193 4.90	25	82	45	148
		82505	NEC: CMP CEC: CMP FT6	5	See Chart 3 (Tech Info Section)	U-1000† 1000†	U-304.8 304.8	29.0 31.0	13.2 14.0	.006 .15	.15 .015	.38 .38	.196 4.98	25	82	45	148
		82506	NEC: CMP CEC: CMP FT6	6	See Chart 3 (Tech Info Section)	U-500† 1000†	U-152.4 U-304.8	17.5 34.0	8.0 15.5	.006 .15	.15 .015	.38 .38	.209 5.31	25	82	45	148
		82509	NEC: CMP CEC: CMP FT6	9	See Chart 3 (Tech Info Section)	1000†	304.8	49.0	22.3	.006 .15	.15 .015	.38 .38	.246 6.25	23	75	42	138

Plenum • FEP Insulation • Red FEP Jacket

	300V RMS	88641	NEC: CMP CEC: CMP FT6	1	See Chart 3 (Tech Info Section)	100 500† 1000†	30.5 152.4 304.8	2.4 6.0 9.0	1.1 2.7 4.1	.006 .15	.15 .014	.36 .36	.106 2.69	31	102	59	194
		89503	NEC: CMP CEC: CMP FT6	3	See Chart 3 (Tech Info Section)	100 500† 1000†	30.5 152.4 304.8	4.0 10.5 21.0	1.8 4.8 9.5	.006 .15	.15 .014	.36 .36	.175 4.45	21	69	40	131
		89504	NEC: CMP CEC: CMP FT6	4	See Chart 3 (Tech Info Section)	500† 1000†	152.4 304.8	13.0 29.0	6.0 13.1	.006 .15	.15 .014	.36 .36	.192 4.88	21	69	40	131
		89505	NEC: CMP CEC: CMP FT6	5	See Chart 3 (Tech Info Section)	100 1000†	30.5 304.8	4.9 33.0	2.2 15.0	.006 .15	.15 .014	.36 .36	.197 5.00	21	69	40	131

TC = Tinned Copper

* Capacitance between conductors.

** Capacitance between one conductor and other conductors connected to shield.

† Spools and/or UnReel® cartons are one piece, but length may vary ±10% for spools and ±5% for UnReel from length shown.

Overall Beldfoil® Shield

Low-Capacitance Computer Cables for EIA RS-232 and EIA RS-485 Applications

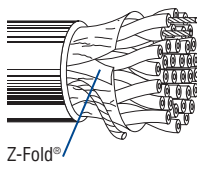
Description	Part No.	UL NEC/ C(UL) CEC Type	No. of Pairs	Color Code	Standard Lengths		Standard Unit Weight		Nom. DCR		Nominal OD		Nom. Imp. (Ω)	Nom. Vel. of Prop.	Nom. Capacitance			
					Ft.	m	Lbs.	kg	Cond.	Shield	Inch	mm			* pF/ Ft.	* pF/ m	** pF/ Ft.	** pF/ m
28 AWG Stranded (7x36) TC Conductors • Twisted Pairs • Overall Beldfoil Shield (100% Coverage) • 28 AWG Stranded TC Drain Wire																		
Datalene® Insulation • Chrome PVC Jacket																		
 <p>UL AWM Style 2919 (30V 80°C)</p> <p>Z-Fold®</p>	8132FO	NEC: CL2	2	See Chart 5 (Tech Info Section)	500 1000	152.4 304.8	8.5 20.0	3.9 9.1	65.0Ω/M' 213.0Ω/km	23.1Ω/M' 75.8Ω/km	.215 5.46	120	78%	11.0	36.1	20.0	65.6	
	8133FO	NEC: CL2	3	See Chart 5 (Tech Info Section)	500 1000	152.4 304.8	11.0 20.0	5.0 9.1	65.0Ω/M' 213.0Ω/km	23.1Ω/M' 75.8Ω/km	.250 6.35	120	78%	11.0	36.1	20.0	65.6	
	8134FO	NEC: CL2	4	See Chart 5 (Tech Info Section)	500 1000	152.4 304.8	13.5 31.0	6.1 14.1	65.0Ω/M' 213.0Ω/km	20.0Ω/M' 65.6Ω/km	.270 6.86	120	78%	11.0	36.1	20.0	65.6	
	8135FO	NEC: CL2	5	See Chart 5 (Tech Info Section)	500 1000	152.4 304.8	14.0 32.0	6.4 14.5	65.0Ω/M' 213.0Ω/km	20.0Ω/M' 65.6Ω/km	.280 7.11	120	78%	11.0	36.1	20.0	65.6	
	8138FO	NEC: CL2	8	See Chart 5 (Tech Info Section)	500 1000	152.4 304.8	22.0 42.0	10.0 19.1	65.0Ω/M' 213.0Ω/km	17.7Ω/M' 58.1Ω/km	.310 7.88	120	78%	11.0	36.1	20.0	65.6	
	8142FO	NEC: CL2	12.5 (12 pairs + 1 single)	See Chart 5 (Tech Info Section)	500 1000	152.4 304.8	27.5 54.0	12.5 24.5	65.0Ω/M' 213.0Ω/km	17.7Ω/M' 58.1Ω/km	.385 9.78	120	78%	11.0	36.1	20.0	65.6	
	8148FO	NEC: CL2	18	See Chart 5 (Tech Info Section)	500 1000	152.4 304.8	38.5 77.0	17.5 35.0	65.0Ω/M' 213.0Ω/km	15.8Ω/M' 51.8Ω/km	.445 11.31	120	78%	11.0	36.1	20.0	65.6	
	8155FO	NEC: CL2	25	See Chart 5 (Tech Info Section)	500 1000	152.4 304.8	42.0 84.0	19.1 38.2	65.0Ω/M' 213.0Ω/km	14.3Ω/M' 47.7Ω/km	.545 13.85	120	78%	11.0	36.1	20.0	65.6	

DCR = DC Resistance • TC = Tinned Copper

*Capacitance between conductors.

**Capacitance between one conductor and other conductors connected to shield.

Datalene insulation features include low dielectric constant and a dissipation factor for high-speed, low-distortion data handling. Physical properties include good crush resistance and light weight.

Overall Beldfoil® Shield

Low-Capacitance Computer Cables for EIA RS-232 and EIA RS-422 Applications

Description	Part No.	UL NEC/ C(UL) CEC Type	No. of Pairs	Color Code	Standard Lengths		Standard Unit Weight		Nom. DCR		Nominal OD		Nom. Imp. (Ω)	Nom. Vel. of Prop.	Nom. Capacitance			
					Ft.	m	Lbs.	kg	Cond.	Shield	Inch	mm			* pF/ Ft.	* pF/ m	** pF/ Ft.	** pF/ m

24 AWG Stranded (7x32) TC Conductors • Twisted Pairs • Overall Beldfoil Shield (100% Coverage) • 24 AWG Stranded TC Drain Wire

Polyethylene Insulation • Chrome PVC Jacket

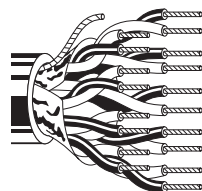
	UL AWM Style 2919 (30V 80°C)	9680	NEC: CM CEC: CM	3 	See Chart 5 (Tech Info Section)	500 1000	152.4 304.8	17.0 38.0	7.7 17.3	24.0Ω/M' 78.7Ω/km	14.4Ω/M' 47.2Ω/km	.282 7.16	100	66%	15.5	50.8	27.5	90.2
		9681	NEC: CM CEC: CM	4 	See Chart 5 (Tech Info Section)	500 1000	152.4 304.8	24.0 45.0	10.9 20.5	24.0Ω/M' 78.7Ω/km	14.4Ω/M' 47.2Ω/km	.307 7.80	100	66%	15.5	50.8	27.5	90.2
		9682	NEC: CM CEC: CM	6 	See Chart 5 (Tech Info Section)	500 1000	152.4 304.8	29.5 56.0	13.4 25.5	24.0Ω/M' 78.7Ω/km	13.1Ω/M' 43.0Ω/km	.342 8.69	100	66%	15.5	50.8	27.5	90.2
		9683	NEC: CM CEC: CM	9 	See Chart 5 (Tech Info Section)	500 1000	152.4 304.8	38.0 79.0	17.2 35.9	24.0Ω/M' 78.7Ω/km	12.0Ω/M' 39.4Ω/km	.397 10.10	100	66%	15.5	50.8	27.5	90.2
		9684	NEC: CM CEC: CM	12.5 (12 prs.+ 1 single)	See Chart 5 (Tech Info Section)	500 1000	152.4 304.8	49.5 97.0	22.6 44.1	24.0Ω/M' 78.7Ω/km	12.0Ω/M' 39.4Ω/km	.445 11.30	100	66%	15.5	50.8	27.5	90.2

Datalene® Insulation • Chrome PVC Jacket

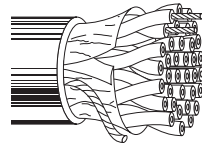
	UL AWM Style 2919 (30V 80°C)	1419A	NEC: CM CEC: CM FT1	2 	See Chart 5 (Tech Info Section)	500 1000 10000	152.4 304.8 3048.0	13.5 30.0 310.0	6.1 13.6 140.9	24.0Ω/M' 78.7Ω/km	15.1Ω/M' 49.5Ω/km	.248 6.30	100	78%	13	42.7	22	72
		1420A	NEC: CM CEC: CM FT 1	3 	See Chart 5 (Tech Info Section)	500 1000 10000	152.4 304.8 3048.0	15.0 34.0 340.0	6.8 15.5 154.5	24.0Ω/M' 78.7Ω/km	15.1Ω/M' 49.5Ω/km	.261 6.63	100	78%	13	42.7	22	72
		1421A	NEC: CM CEC: CM	4 	See Chart 5 (Tech Info Section)	500 1000	152.4 304.8	16.5 37.0	7.5 16.8	24.0Ω/M' 78.7Ω/km	14.4Ω/M' 47.2Ω/km	.280 7.11	100	78%	13	42.7	22	72
		1422A	NEC: CM CEC: CM	5 	See Chart 5 (Tech Info Section)	500 1000	152.4 304.8	23.0 43.0	10.5 19.5	24.0Ω/M' 78.7Ω/km	14.4Ω/M' 47.2Ω/km	.294 7.47	100	78%	13	42.7	22	72
		1423A	NEC: CM CEC: CM	6 	See Chart 5 (Tech Info Section)	500 1000 10000	152.4 304.8 3048.0	25.0 48.0 500.0	11.4 21.8 227.3	24.0Ω/M' 78.7Ω/km	13.0Ω/M' 42.7Ω/km	.319 8.10	100	78%	13	42.7	22	72
		1424A	NEC: CM CEC: CM	12.5 (12 prs.+ 1 single)	See Chart 5 (Tech Info Section)	500 1000	152.4 304.8	43.0 85.0	19.5 38.6	24.0Ω/M' 78.7Ω/km	13.0Ω/M' 42.7Ω/km	.418 10.62	100	78%	13	42.7	22	72
		1425A	NEC: CM CEC: CM	15 	See Chart 5 (Tech Info Section)	500 1000	152.4 304.8	53.0 99.0	24.1 45.0	24.0Ω/M' 78.7Ω/km	11.2Ω/M' 36.7Ω/km	.473 12.01	100	78%	13	42.7	22	72

DCR = DC Resistance • TC = Tinned Copper

*Capacitance between conductors.

**Capacitance between one conductor and other conductors connected to shield.

Datalene insulation features include low dielectric constant and a dissipation factor for high-speed, low-distortion data handling. Physical properties include good crush resistance and light weight.



Overall Beldfoil® Shield

Audio, Control and Instrumentation Cables
Plenum-Rated and Non-Plenum

Description	Part No.	UL NEC/ C(UL) CEC Type	No. of Pairs	Color Code	Standard Lengths		Standard Unit Weight		Insulation Thickness		Jacket Thickness		Nominal OD		Nominal Capacitance			
					Ft.	m	Lbs.	kg	Inch	mm	Inch	mm	Inch	mm	* pF/ Ft.	* pF/ m	** pF/ Ft.	** pF/ m

24 AWG Stranded (7x32) TC Conductors • Twisted Pair • Overall Beldfoil Shield* (100% Coverage) • 24 AWG Stranded TC Drain Wire

Polyolefin Insulation • Black Matte PVC Jacket

High-Flex 300V RMS	1508A	NEC: CM	1	Black, Red	500	152.4	6.5	2.9	.008	.20	.024	.61	.131	3.33	31	102	58	190
					1000	304.8	11.0	5.0										



Jacket and shield are bonded so both can be removed with automatic stripping equipment.

Polypropylene Insulation • PVC Jacket (Available in Gray, Brown, Red, Green, Lt. Blue, Purple, White or Black)

300V RMS	1883A	NEC: CMR	1	Black, Red	U-1000	U-304.8	11.0	5.0	.008	.20	.020	.51	.123	3.12	31	102	58	190
					1000*	304.8	11.0	5.0										



Z-Fold®

* 1000 ft. put-up available in Gray only.

Jacket and shield are bonded so both can be removed with automatic stripping equipment. For cross-connect use with 1408R Snake Cables.

Polyethylene Insulation • Chrome PVC Jacket

UL AWM Style 2092 (300V 60°C)	8641	NEC: CM	1	Black, Clear	100	30.5	2.3	1.0	.016	.41	.025	.64	.168	4.27	22	72	42	138			
					U-500	U-152.4	7.5	3.4													
					500	152.4	7.0	3.2													
					U-1000	U-304.8	14.0	6.4													
		CM			1000	304.8	14.0	6.4													
					2000	609.6	28.0	12.7													



For Plenum versions of 8641, see 88641 or 82641.

Plenum • FEP Insulation • Red FEP Jacket

300V RMS, Non-conduit	88641	NEC: CMP	1	Black, Red	100	30.5	2.4	1.1	.006	.15	.014	.36	.106	2.69	31	102	59	194	
					500†	152.4	6.0	2.7											
					1000†	304.8	9.0	4.1											



CMP FT6

Plenum • FEP Insulation • Natural Flamarrest® Jacket

300V RMS, Non-conduit	82641	NEC: CMP	1	Black, Red	U-1000†	U-304.8	9.0	4.1	.006	.15	.014	.36	.106	2.69	31	102	59	194
					1000†	304.8	8.0	3.6										



CMP FT6

TC = Tinned Copper

*Capacitance between conductors.

**Capacitance between one conductor and other conductors connected to shield.

† Spools and/or UnReel® cartons are one piece, but length may vary ±10% for spools and ±5% for UnReel from length shown.

▲ Beldfoil provides high reliability with ease of termination.

Overall Beldfoil® Shield

Audio, Control and Instrumentation Cables

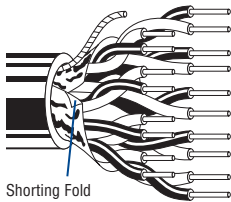
Description	Part No.	UL NEC/ C(UL) CEC Type	No. of Pairs	Color Code	Standard Lengths		Standard Unit Weight		Insulation Thickness		Jacket Thickness		Nominal OD		Nominal Capacitance					
					Ft.	m	Lbs.	kg	Inch	mm	Inch	mm	Inch	mm	* pF/ Ft.	* pF/ m	** pF/ Ft.	** pF/ m		
22 AWG Solid Tinned Copper Conductors • Twisted Pairs • Overall Beldfoil Shield (100% Coverage) • 22 AWG Stranded TC Drain Wire																				
PVC Insulation • Chrome PVC Jacket																				
 <p>Shorting Fold</p>	9302	UL AWM Style 2464 (300V 80°C)	NEC:	2	See	U-500	U-152.4	15.5	7.0	.013	.33	.032	.81	.244	6.20	35	115	50	164	
		CMG		Chart 3	500	152.4	15.0	6.8												
		CEC:		(Tech Info Section)	1000	304.8	29.0	13.2												
			CMG FT4																	
		9305		NEC:	4	See	100	30.5	4.9	2.2	.013	.33	.032	.81	.265	6.73	35	115	50	164
	CMG			Chart 3	U-500	U-152.4	22.0	10.0												
	CEC:			(Tech Info Section)	500	152.4	22.5	10.2												
			CMG FT4				U-1000	U-304.8	43.0	19.5										
				NEC:	6	See	500	152.4	31.5	14.3	.013	.33	.032	.81	.315	8.00	35	115	50	164
			CMG		Chart 3	1000	304.8	62.0	28.2											
		CEC:		(Tech Info Section)																
		CMG FT4																		
	9309		NEC:	9	See	500	152.4	44.5	20.2	.013	.33	.033	.84	.363	9.22	35	115	50	164	
CMG			Chart 3	1000	304.8	86.0	39.1													
CEC:			(Tech Info Section)																	
		CMG FT4																		
	9315		NEC:	15	See	500	152.4	67.0	30.5	.013	.33	.037	.94	.449	11.41	35	115	50	164	
CMG			Chart 3	1000	304.8	133.0	60.5													
CEC:			(Tech Info Section)																	
		CMG FT4																		
	9319		NEC:	19	See	500	152.4	85.0	38.6	.013	.33	.040	1.02	.495	12.57	35	115	50	164	
CMG			Chart 3	1000	304.8	165.0	75.0													
CEC:			(Tech Info Section)																	
		CMG FT4																		
	9327		NEC:	27	See	500	152.4	116.0	52.7	.013	.33	.045	1.14	.615	15.62	35	115	50	164	
CMG			Chart 3	1000	304.8	230.0	104.5													
CEC:			(Tech Info Section)																	
		CMG FT4																		
300V RMS, 60°C	8751		NEC:	51	Request	1000†	304.8	384.0	174.5	.010	.25	.050	1.27	.710	18.03	30	98	42.8	140	
			CMG		Technical															
			CEC:		Bulletin															
		CMG FT4		T/8-4																

For 38-pair polypropylene version of 8751, see 8752.

Description	Part No.	UL NEC/ C(UL) CEC Type	No. of Pairs	Color Code	Standard Lengths		Standard Unit Weight		Nom. DCR		Nominal OD		Nom. Imp. (Ω)	Nom. Vel. of Prop.	Nom. Capacitance				
					Ft.	m	Lbs.	kg	Cond.	Shield	Inch	mm			* pF/ Ft.	* pF/ m	** pF/ Ft.	** pF/ m	
22 AWG Solid Tinned Copper Conductors • Twisted Pairs • Duofoil® Shield (100% Coverage) • 22 AWG Stranded Tinned Copper Drain Wire																			
Datalene® Insulation • Black PVC Jacket																			
	9184	UL AWM Style 2668 (300V 60°C)	NEC:	2	Black & Yellow,	500	152.4	29.0	13.2	16.5Ω/M'	8.0Ω/M'	.385	9.78	150	78%	8.7	28.5	14.1	46.3
		CM		Chart 3	1000	304.8	59.0	26.8	54.13Ω/km	26.2Ω/km									
		CEC:		(Tech Info Section)															
		CM			Red & Blue														

DCR = DC Resistance • TC = Tinned Copper

*Capacitance between conductors.

**Capacitance between one conductor and other conductors connected to shield.

† Spools are one piece, but length may vary -0 to +20% from length shown.

Datalene insulation features include low dielectric constant and a dissipation factor for high-speed, low-distortion data handling. Physical properties include good crush resistance and light weight.

See Attenuation, Rise Time and Bit Rate data for this series on page 5.10.

Overall Beldfoil® Shield

Audio, Control and Instrumentation Cables

Description	Part No.	UL NEC/ C(UL) CEC Type	No. of Pairs	Color Code	Standard Lengths		Standard Unit Weight		Insulation Thickness		Jacket Thickness		Nominal OD		Nominal Capacitance			
					Ft.	m	Lbs.	kg	Inch	mm	Inch	mm	Inch	mm	* pF/ Ft.	* pF/ m	** pF/ Ft.	** pF/ m

22 AWG Solid Tinned Copper Conductors • Twisted Pairs • Overall Beldfoil Shield (100% Coverage) • 22 AWG Solid TC Drain Wire*

Polypropylene Insulation • Gray or Black PVC Jacket

 <p>Z-Fold®</p>	8450	NEC:	1	Black, Red	U-500 [▲]	U-152.4	7.5	3.4	.007	.18	.018	.46	.118	3.00	40	131	76	249			
		CM			U-1000 [▲]	U-304.8	14.0	6.4													
		CEC:				1000	304.8	13.0	5.9												
		CM																			

[▲]U-500 ft. and U-1000 ft. put-ups available in Black only.
Belden's Miniature Type Broadcast Audio and Instrumentation Cables occupy 1/2 to 2/3 less space than standard cables.

Polypropylene Insulation • Chrome PVC Jacket

	8752		38	Request Tech Bulletin T/8-4	250 [†]	76.2	65.0	29.5	.008	.20	.045	1.14	.610	15.50	17	56	24.3	80				
					1000 [†]	304.8	256.0	116.4														

*8752 has a stranded tinned copper drain wire.

22 AWG Stranded (7x30) Tinned Copper Conductors • Twisted Pair • Overall Beldfoil Shield (100% Coverage) • 22 AWG Stranded TC Drain Wire

Semi-rigid PVC Insulation • Pale Fawn Beige Striated PVC Jacket

	9414	NEC:	1	White, Black	U-500	U-152.4	12.0	5.5	.010	.25	.035	.89	.186	4.72	50	164	95	312			
		CMG			500	152.4	11.5	5.2													
		CEC:				U-1000	U-304.8	23.0	10.5												
		CMG FT4				1000	304.8	23.0	10.5												

PVC Insulation • Chrome PVC Jacket

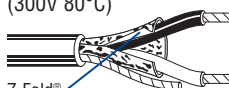
 <p>Z-Fold®</p>	9462	NEC:	1	Black, Red	100	30.5	3.0	1.4	.013	.33	.035	.89	.186	4.72	50	164	90	295			
		CMG			U-500	U-152.4	11.0	5.0													
		CEC:				500	152.4	10.5	4.8												
		CMG FT4				U-1000	U-304.8	21.0	9.5												
					1000	304.8	21.0	9.5													

Polyethylene Insulation • Chrome PVC Jacket

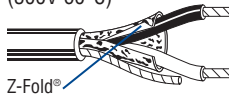
 <p>Z-Fold®</p>	8761	NEC:	1	Black, Clear	U-500	U-152.4	9.0	4.1	.016	.41	.025	.64	.175	4.45	24	79	47	154				
		CM			500	152.4	9.0	4.1														
		CEC:				U-1000	U-304.8	17.0	7.7													
		CM				1000	304.8	18.0	8.2													
								2000	609.6	36.0	16.3											
								5000	1524.0	90.0	40.9											
				10000 ^{††}	3048.0	170.0	77.3															

For Plenum versions of 8761, see 88761, 87761 or 82761.

	9461	NEC:	1	Black, Clear	U-500	U-152.4	11.0	5.0	.016	.41	.026	.66	.180	4.57	24	79	47	154	
		CM			U-1000	U-304.8	21.0	9.6											
		CEC:																	
		CM																	

The jacket and shield are bonded so both can be removed on automatic stripping equipment.

TC = Tinned Copper

*Capacitance between conductors.

**Capacitance between one conductor and other conductors connected to shield.

[†] Spools are one piece, but length may vary -0 to +20% from length shown.

^{††} Length may vary -10% to +20% and may contain 2 pieces. Minimum length of any piece is 1500 ft.

Overall Beldfoil® Shield

Audio, Control and Instrumentation Cables

Description	Part No.	UL NEC/ C(UL) CEC Type	No. of Pairs	Color Code	Standard Lengths		Standard Unit Weight		Insulation Thickness		Jacket Thickness		Nominal OD		Nominal Capacitance			
					Ft.	m	Lbs.	kg	Inch	mm	Inch	mm	Inch	mm	* pF/ Ft.	* pF/ m	** pF/ Ft.	** pF/ m

22 AWG Stranded (7x30) TC Conductors • Twisted Pair • Overall Beldfoil Shield (100% Coverage) • 22 AWG Stranded TC Drain Wire (continued)

Polypropylene Insulation • Paper Wrap • Gray or Black PVC Jacket

 <p>300V RMS 75°C</p> <p>Z-Fold®</p>	8451	NEC:	1	Black, Red	100*	30.5	2.3	1.1	.008	.20	.020	.51	.138	3.51	34	112	67	220				
		CMR			U-500	U-152.4	8.5	3.8														
		CEC:			500	152.4	8.0	3.6														
		CMG			U-1000	U-304.8	16.0	7.3														
					1000	304.8	16.0	7.3														

*100 ft. put-up available in Black only.
Unique paper separator facilitates jacket stripping.

Polypropylene Insulation • PVC Jacket (Available in Black, Gray, Brown, Red, Orange, Yellow, Green, Blue, Purple or White)

 <p>300V RMS 75°C</p>	9451	NEC:	1	Black, Red	U-500 [▲]	U-152.4	8.5	3.9	.008	.20	.020	.51	.135	3.43	35	115	67	220				
		CMR			500 [▲]	152.4	8.0	3.6														
		CEC:			T-1000 [▲]	T-304.8	18.0	8.2														
		CMG FT4			U-1000	U-304.8	15.0	6.8														
					5000	1524.0	75.0	34.0														

[▲]U-500 ft., 500 ft. and T-1000 ft. put-ups available in Gray only.
The jacket and shield are bonded so both can be removed on automatic stripping equipment. Drain wire is inside foil shield.

Polypropylene Insulation • Black Low-Smoke, Zero-Halogen Jacket

 <p>300V RMS 105°C</p>	9451SB <small>new</small>	NEC:	1	Black, Red	1000	304.8	20.0	9.1	.008	.20	.032	.81	.160	4.06	35	115	67	220				
		CMG-LS																				
		CEC:			CMG-LS FT4																	
		CMG-LS FT4			Limited Smoke																	

The jacket and shield are bonded so both can be removed on automatic stripping equipment. Drain wire is inside foil shield.

Polyolefin Insulation • PVC Jacket in Zip-Cord Construction (Red & Green, Red & Black, Red & Purple or Red & Gray)

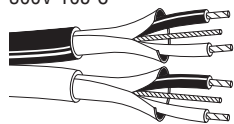
 <p>300V 105°C</p>	9451D	NEC:	2	Black, Red	U-1000	U-304.8	29.0	13.2	.008	.20	.020	.51	.135	3.43	34	112	67	220				
		CMR			2000*	620.8	62.0	28.1								x	x					
		CEC:															.270	6.86				
		CMR FT4																				

*2000 ft. put-up available in Red & Green only.
The jacket and shield are bonded so both can be removed on automatic stripping equipment. Drain wire is inside foil shield.

Plenum • FEP Insulation • White Flamarrest® Jacket in Zip-Cord Construction

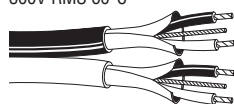
 <p>300V RMS 60°C</p>	9451DP <small>new</small>	NEC:	2	Black & Red, Black & White	1000	304.8	24.0	10.9	.007	.18	.017	.43	.127	3.23	35	115	67	220			
		CMP														x	x				
		CEC:			CMP FT6												.269	6.83			

The jacket and shield are bonded so both can be removed on automatic stripping equipment. Drain wire is inside foil shield.

22 AWG Stranded (7x30) TC Conductors • Twisted Pairs • Overall Beldfoil Shield (100% Coverage) • 24 AWG Stranded TC Drain Wire

Polypropylene Insulation • PVC Jacket (Available in Brown, Red, Orange, Yellow, Green, Blue, Purple, Gray, White or Black)

 <p>300V RMS</p>	1266A	NEC:	1	Black, Red	U-1000	U-304.8	15.0	6.8	.010	.25	.020	.51	.143	3.63	30	99	54	177				
		CM			1000†	304.8	15.0	6.8														
		CEC:																				
		CM																				

†1000 ft. put-up available in Black only.
Unique design features lower capacitance and greater flexibility than standard audio pair constructions.

PVC Insulation • PVC Jacket (Available in Brown, Red, Orange, Yellow, Green, Blue, Purple, Gray, White or Black)

 <p>300V 90°C</p>	1503A	NEC:	1	Black, Red	U-1000	U-304.8	16.0	7.3	.010	.25	.020	.51	.142	3.61	53	174	97	318				
		CM																				
		CEC:																				
		CM																				

TC = Tinned Copper

*Capacitance between conductors.
**Capacitance between one conductor and other conductors connected to shield.

Overall Beldfoil® Shield

Audio, Control and Instrumentation Cables
Plenum-Rated and Non-Plenum

Description	Part No.	UL NEC/ C(UL) CEC Type	No. of Pairs	Color Code	Standard Lengths		Standard Unit Weight		Insulation Thickness		Jacket Thickness		Nominal OD		Nominal Capacitance			
					Ft.	m	Lbs.	kg	Inch	mm	Inch	mm	Inch	mm	* pF/ Ft.	* pF/ m	** pF/ Ft.	** pF/ m

22 AWG Stranded (7x30) TC Conductors • Twisted Pair • Overall Beldfoil Shield (100% Coverage) • 22 AWG Stranded TC Drain Wire

Plenum • FEP Insulation • Red FEP Jacket

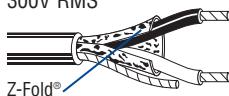
 <p>Z-Fold®</p>	300V RMS	88761	NEC:	1	Black,	100†	30.5	2.7	1.2	.006	.15	.014	.36	.119	3.02	35	115	67	220	
			CMP		Red	U-500†	U-152.4	7.5	3.4											
			CEC:				500†	152.4	7.5	3.4										
			CMP FT6				U-1000†	U-304.8	15.0	6.8										
							1000†	304.8	12.0	5.4										

Plenum • FEP Insulation • Red Fluorocopolymer Jacket

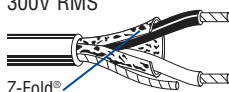
 <p>Z-Fold®</p>	300V RMS	87761	NEC:	1	Black,	500†	152.4	7.0	3.2	.006	.15	.014	.36	.116	2.95	35	115	67	220	
			CMP		Red	1000†	304.8	11.0	5.0											
			CEC:																	
			CMP FT6																	

Plenum • FEP Insulation • Natural Flammarrest® Jacket

 <p>Z-Fold®</p>	300V RMS	82761	NEC:	1	Black,	U-500†	U-152.4	7.0	3.2	.006	.15	.014	.36	.116	2.95	35	115	67	220
			CMP		Red	U-1000†	U-304.8	14.0	6.4										
			CEC:				1000†	304.8	11.0	5.0									
			CMP FT6																

Plenum • FEP Insulation • Flammarrest Jacket (Black, Gray, Brown, Red, Orange, Yellow, Green, Blue, Purple or White)

	300V RMS 60°C	9451P <small>new</small>	NEC:	1	Black,	U-1000	U-304.8	15.0	6.8	.007	.18	.017	.43	.127	3.23	35	115	67	220
			CMP		Red	5000	1524.0	75.0	34.0										
			CEC:																
			CMP FT6																

The jacket and shield are bonded so both can be removed on automatic stripping equipment. Drain wire is inside foil shield.

22 AWG Stranded (19x34) TC Conductors • Dual Twisted Pairs • Overall Beldfoil Shield (100% Coverage) • 24 AWG Stranded TC Drain Wire

PVC Insulation • PVC Jacket in Zip-Cord Construction (Red & Green, Red & Black, Red & Purple or Red & Gray)

	Stereo Audio 150V RMS	1504A	NEC:	2	Black,	U-1000	U-304.8	32.0	14.5	.010	.25	.020	.51	.143	3.63	57	187	100	328
			CM		Red	2000††	609.8	64.0	29.0					x	x				
			CEC:												.286	7.26			
			CM																

††2000 ft. put-up available in Red & Gray or Red & Green only.
The jacket and shield are bonded so both can be removed on automatic stripping equipment. Drain wire is inside foil shield.

20 AWG Stranded (7x28) TC Conductors • Twisted Pair • Overall Beldfoil Shield (100% Coverage) • 20 AWG Stranded TC Drain Wire

Polyethylene Insulation • Chrome PVC Jacket

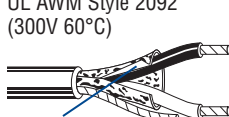
 <p>Shorting Fold</p>	UL AWM Style 2092 (300V 60°C)	8762	NEC:	1	Black,	100	30.5	3.2	1.5	.016	.41	.028	.71	.204	5.18	27	89	49	161	
			CM		Clear	250	76.2	6.3	2.8											
			CEC:				U-500	U-152.4	12.0	5.5										
			CM				500	152.4	12.0	5.5										
							U-1000	U-304.8	23.0	10.5										
							1000	304.8	23.0	10.5										
							2000	609.6	46.0	20.9										

	UL AWM Style 2092 (300V 60°C)	9464	NEC:	1	Black,	U-500	U-152.4	17.0	7.7	.016	.41	.035	.89	.214	5.44	27	89	49	161
			CM		Clear	U-1000	U-304.8	32.0	14.5										
			CEC:																

The jacket and shield are bonded so both can be removed on automatic stripping equipment. Drain wire is on the inside of foil shield.

TC = Tinned Copper

*Capacitance between conductors.

**Capacitance between one conductor and other conductors connected to shield.

†Spools and/or UnReel® cartons are one piece, but length may vary ±10% for spools and ±5% for UnReel from length shown.



Overall Beldfoil® Shield

Audio, Control and Instrumentation Cables

Plenum-Rated and Non-Plenum

Description	Part No.	UL NEC/ C(UL) CEC Type	No. of Pairs	Color Code	Standard Lengths		Standard Unit Weight		Insulation Thickness		Jacket Thickness		Nominal OD		Nominal Capacitance			
					Ft.	m	Lbs.	kg	Inch	mm	Inch	mm	Inch	mm	* pF/ Ft.	* pF/ m	** pF/ Ft.	** pF/ m

20 AWG Stranded (7x28) TC Conductors • Twisted Pair • Overall Beldfoil Shield (100% Coverage) • 20 AWG Stranded TC Drain Wire (cont.)
PVC Insulation • Beige PVC Jacket

 <p>Z-Fold®</p>	9154 UL AWM Style 2464 (300V 80°C)	NEC: 1 Black,	U-500 U-152.4 11.5 5.2 500 152.4 12.0 5.5 U-1000 U-304.8 22.0 10.0 1000 304.8 23.0 10.5	.014 .36 .031 .79 .198 5.03	60 197 100 328
		CMG Red			
		CEC:			
		CMG FT4			

9154 has 22 AWG stranded tinned copper drain wire.

18 AWG Stranded (16x30) TC Conductors • Twisted Pair • Overall Beldfoil Shield (100% Coverage) • 20 AWG Stranded TC Drain Wire
Polyethylene Insulation • Chrome PVC Jacket

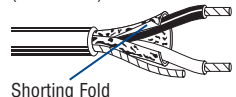
 <p>Shorting Fold</p>	8760 UL AWM Style 2092 (300V 60°C)	NEC: 1 Black,	250 76.2 6.8 3.1 U-500 U-152.4 13.5 6.1 500 152.4 13.0 5.9 U-1000 U-304.8 25.0 11.3 1000 304.8 26.0 11.8 2000 609.6 50.0 22.7 5000 1524.0 135.0 61.4 10000 3048.0 260.0 118.2	.019 .48 .028 .71 .222 5.64	24 79 44 144	
		CM Clear				
		CEC:				
		CM				
		For Plenum versions of 8760, see 88760, 87760 or 82760.				
		CM				

	9460	NEC: 1 Black,	U-500 U-152.4 18.5 8.4 U-1000 U-304.8 36.0 16.4	.019 .48 .030 .76 .230 5.84	24 79 44 144
		CM Clear			
		CEC:			
		CM			

The jacket and shield are bonded so both can be removed on automatic stripping equipment. Drain wire is on the inside of foil shield.

18 AWG Stranded (19x30) TC Conductors • Twisted Pair • Overall Beldfoil Shield (100% Coverage) • 20 AWG Stranded TC Drain Wire
Plenum • FEP Insulation • Red FEP Jacket

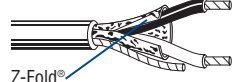
 <p>Z-Fold®</p>	88760 300V RMS	NEC: 1 Black,	100 30.5 3.7 1.7 U-500 U-152.4 12.5 5.7 500† 152.4 11.0 5.0 U-1000 U-304.8 24.0 10.9 1000† 304.8 22.0 10.0	.007 .18 .014 .36 .150 3.81	51 167 97 318
		CMP Red			
		CEC:			
		CMP FT6			

Plenum • FEP Insulation • Red Fluorocopolymer Jacket

 <p>Z-Fold®</p>	87760 300V RMS	NEC: 1 Black,	U-500 U-152.4 12.5 5.7 500† 152.4 10.5 4.8 1000† 304.8 21.0 9.5	.007 .18 .014 .36 .150 3.81	51 167 97 318
		CMP Red			
		CEC:			
		CMP FT6			

Plenum • FEP Insulation • Natural Flamarrest® Jacket

 <p>Z-Fold®</p>	82760 300V RMS	NEC: 1 Black,	U-500† U-152.4 12.0 5.4 U-1000† U-304.8 22.0 10.0 1000† 304.8 21.0 9.5	.007 .18 .014 .36 .150 3.81	51 167 97 318
		CMP Red			
		CEC:			
		CMP FT6			

TC = Tinned Copper

*Capacitance between conductors.

**Capacitance between one conductor and other conductors connected to shield.

† Spools and/or UnReel® cartons are one piece, but length may vary ±10% for spools and ±5% for UnReel from length shown.

Overall Beldfoil® Shield

Audio, Control and Instrumentation Cables

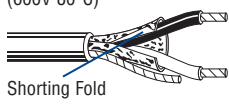
Description	Part No.	UL NEC/ C(UL) CEC Type	No. of Pairs	Color Code	Standard Lengths		Standard Unit Weight		Insulation Thickness		Jacket Thickness		Nominal OD		Nominal Capacitance							
					Ft.	m	Lbs.	kg	Inch	mm	Inch	mm	Inch	mm	* pF/ Ft.	* pF/ m	** pF/ Ft.	** pF/ m				
16 AWG Stranded (19x29) TC Conductors • Twisted Pair • Overall Beldfoil Shield (100% Coverage) • 18 AWG Stranded TC Drain Wire																						
Polyethylene Insulation • Chrome PVC Jacket																						
UL AWM Style 20253 (600V 80°C)  Shorting Fold	8719	NEC: CM, CL2 CEC: CM	1	Black, Clear	U-500	U-152.4	24.0	11.1	.032	.81	.032	.81	.313	7.95	23	75	44	144				
					500	152.4	25.5	11.6														
					U-1000	U-304.8	47.0	21.3														
					1000	304.8	50.0	22.7														
					2000	609.6	100.0	45.5														
					5000	1524.0	245.0	111.4														
					10000	3048.0	510.0	231.3														

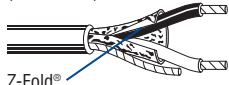
14 AWG Stranded (19x27) TC Conductors • Twisted Pair • Overall Beldfoil Shield (100% Coverage) • 16 AWG Stranded TC Drain Wire																						
Polyethylene Insulation • Chrome PVC Jacket																						
UL AWM Style 20253 (600V 80°C)  Z-Fold®	8720	NEC: CM, CL2	1	Black, Clear	U-500	U-152.4	34.0	15.4	.032	.81	.035	.89	.355	9.02	24	79	47	154				
					500	152.4	35.0	15.9														
					1000	304.8	71.0	32.3														
					2000	609.6	138.0	62.7														

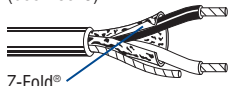
12 AWG Stranded (19x25) TC Conductors • Twisted Pair • Overall Beldfoil Shield (100% Coverage) • 14 AWG Stranded TC Drain Wire																						
Polyethylene Insulation • Chrome PVC Jacket																						
UL AWM Style 20253 (600V 80°C)  Z-Fold®	8718	NEC: CL2	1	Black, Clear	U-500	U-152.4	47.5	21.6	.037	.94	.040	1.02	.400	10.16	25	82	49	161				
					500	152.4	50.5	22.9														
					1000	304.8	100.0	45.5														
					2000	609.6	198.0	90.0														

TC = Tinned Copper

*Capacitance between conductors.

**Capacitance between one conductor and other conductors connected to shield.

Combination Unshielded and Braid Shield and Overall Braid Shield

Audio, Control and Instrumentation Cables

Description	Part No.	UL NEC/ C(UL) CEC Type	No. of Pairs	Color Code	Standard Lengths		Standard Unit Weight		Insulation Thickness		Jacket Thickness		Nominal OD		Nominal Capacitance			
					Ft.	m	Lbs.	kg	Inch	mm	Inch	mm	Inch	mm	* pF/ Ft.	* pF/ m	** pF/ Ft.	** pF/ m

Combination • 22 AWG Stranded (7x30) TC Conductors • Conductors Cabled • TC Braid Shield Over One Pair (62% Coverage)

Polyethylene Insulation • Chrome PVC Jacket

	8732	UL AWM Style 2094 (300V 60°C)	NEC: 2: Black, CM (1) Shld CEC: (1) Unshld CM	Color Code: Clear	500	152.4	17.5	7.9	.020	.51	.030	.76	.206	5.23	21	69	37	121	
		U-1000	U-304.8	37.0	16.8					x	x								
		1000	304.8	39.0	17.7									.332	8.43				

Overall Braid • 22 AWG Solid TC Conductors • Twisted Pair • Polyester Tape + TC Braid Shield (88% Coverage) • 22 AWG Solid TC Drain Wire

PVC Insulation • Black PVC Jacket

	8437	UL AWM Style 2095 (300V 80°C)	NEC: 1 CMG CEC: CMG FT4	Color Code: Black, Red	1000	304.8	25.0	11.4	.015	.38	.025	.64	.200	5.08	48	157	85	279		

Overall Braid • 22 AWG Stranded (7x30) TC Conductors • Twisted Pair • Polyester Tape + TC Braid Shield (86% Coverage) • Stranded TC Drain Wire

PVC Insulation • Black PVC Jacket

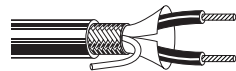
	8441	UL AWM Style 2095 (300V 80°C)	NEC: 1 CMG CEC: CMG FT4	Color Code: Black, Red	100	30.5	3.6	1.6	.015	.38	.025	.64	.210	5.33	49	161	86	282	
		U-500	U-152.4	14.0	6.4														
		500	152.4	14.0	6.4														
		U-1000	U-304.8	27.0	12.3														

Overall Braid • 18 AWG Stranded (16x30) Tinned Copper Conductors • Twisted Pair • Separator + TC Braid Shield (73% Coverage)

Rubber Insulation • Chrome PVC Jacket

	8208	300V RMS 80°C	NEC: 1 CMG CEC: CMG FT4	Color Code: Red, White	100	30.5	4.7	2.1	.022	.56	.025	.64	.257	6.53	46	151	77	253	
		U-500	U-152.4	21.5	9.8														
		500	152.4	20.0	9.1														
		U-1000	U-304.8	42.0	19.1														

TC = Tinned Copper

*Capacitance between conductors.

**Capacitance between one conductor and other conductors connected to shield.

Overall Spiral Shield

Audio, Control and Instrumentation Cables

Description	Part No.	UL NEC/ C(UL) CEC Type	No. of Pairs	Color Code	Standard Lengths		Standard Unit Weight		Insulation Thickness		Jacket Thickness		Nominal OD		Nominal Capacitance			
					Ft.	m	Lbs.	kg	Inch	mm	Inch	mm	Inch	mm	* pF/ Ft.	* pF/ m	** pF/ Ft.	** pF/ m

Overall Spiral • 22 AWG Stranded (7x30) Tinned Copper Conductors • Twisted Pair • Tinned Copper Spiral Wrapped Shield (85% Coverage)

PVC Insulation • Chrome PVC Jacket																			
	UL AWM Style 2095 (300V 80°C)	8737	NEC:	1	Black,	U-500	U-152.4	10.5	4.8	.015	.38	.025	.64	.180	4.57	40	131	70	230
			CMG:		Red	500	152.4	10.0	4.5										
			CEC:			U-1000	U-304.8	20.0	9.1										
			CMG FT4			1000	304.8	20.0	9.1										

Overall Spiral • 20 AWG Stranded (7x28) Tinned Copper Conductors • Twisted Pair • Tinned Copper Spiral Wrapped Shield (89% Coverage)

PVC Insulation • Chrome PVC Jacket																			
	UL AWM Style 2095 (300V 80°C)	8759	NEC:	1	Black,	U-500	U-152.4	12.5	5.7	.016	.41	.025	.64	.199	5.05	47	154	79	259
			CMG:		Red	U-1000	U-304.8	24.0	10.9										
			CEC:			1000	304.8	25.0	11.4										
			CMG FT4																

Overall Spiral • 18 AWG Stranded (7x26) Tinned Copper Conductors • Twisted Pair • Tinned Copper Spiral Wrapped Shield (85% Coverage)

PVC Insulation • Chrome PVC Jacket																			
	300V RMS 60°C	8790	NEC:	1	Red,	U-500	U-152.4	17.5	7.9	.022	.56	.028	.71	.241	6.12	53	174	92	302
			CMG:		White	500	152.4	17.0	7.7										
			CEC:			U-1000	U-304.8	33.0	15.0										
			CMG FT4			1000	304.8	35.0	15.9										

Overall Spiral • 16 AWG Stranded (19x29) Tinned Copper Conductors • Twisted Pair • Tinned Copper Spiral Wrapped Shield (85% Coverage)

PVC Insulation • Chrome PVC Jacket																			
	300V RMS 60°C	8780	NEC:	1	Black,	500	152.4	23.5	10.7	.023	.58	.030	.76	.280	7.11	57	187	98	322
			CMG:		White	U-1000	U-304.8	44.0	20.0										
			CEC:			1000	304.8	46.0	20.9										
			CMG FT4																

*Capacitance between conductors.
**Capacitance between one conductor and other conductors connected to shield.

Overall Foil/Braid Shield

Cable Characteristics

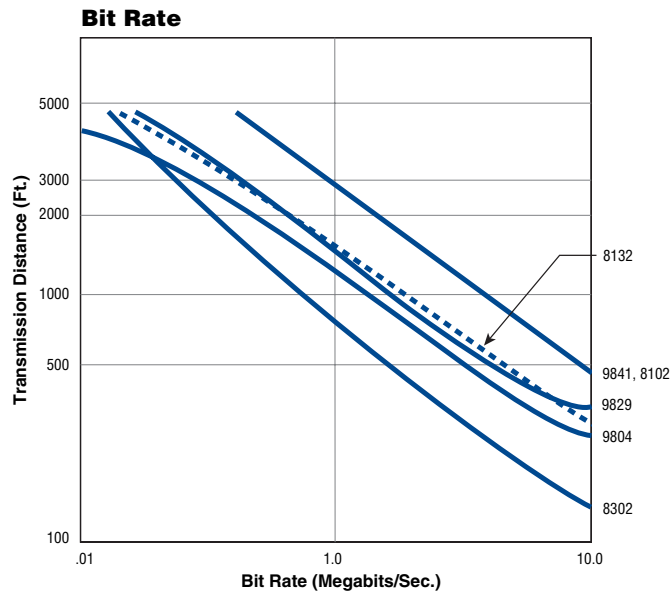
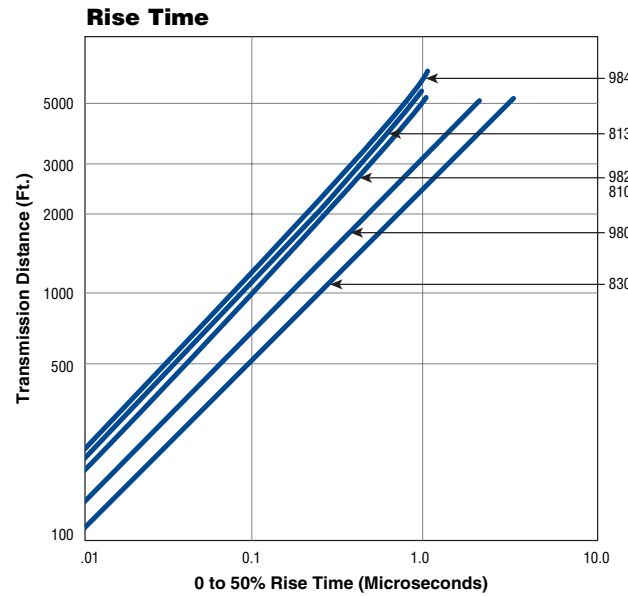
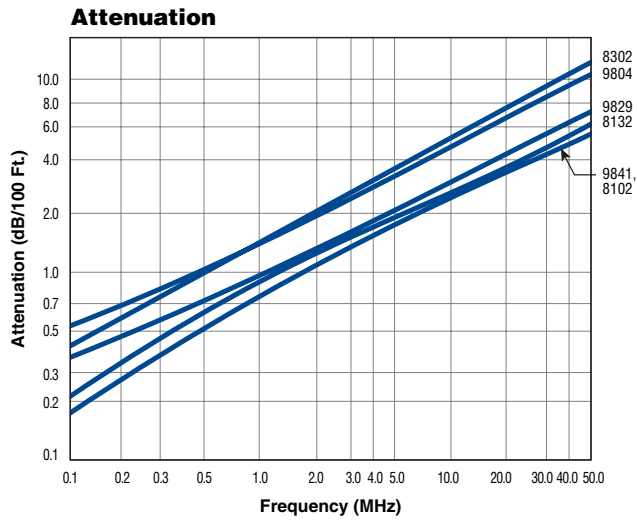

Overall Foil/Braid Shield

Low-Capacitance Computer Cables for EIA RS-232 and EIA RS-422 Applications

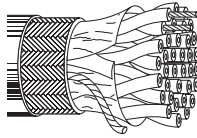
Description	Part No.	UL NEC/ C(UL) CEC Type	No. of Pairs	Color Code	Standard Lengths		Standard Unit Weight		Nom. DCR		Nominal OD		Nom. Imp. (Ω)	Nom. Vel. of Prop.	Nom. Capacitance			
					Ft.	m	Lbs.	kg	Cond.	Shield	Inch	mm			* pF/ Ft.	* pF/ m	** pF/ Ft.	** pF/ m
28 AWG Stranded (7x36) TC Conductors • Overall Beldfoil® (100% Coverage) + TC Braid Shield (90% Coverage) • 28 AWG Stranded TC Drain Wire																		
Polypropylene Insulation • Chrome PVC Jacket																		
	UL AWM Style 2960 (30V 60°C)	9804	NEC: CL2	2	See Chart 3 (Tech Info Section)	100 500 1000	30.5 152.4 304.8	3.9 14.5 32.0	1.8 6.6 14.5	64.9Ω/M' 212.9Ω/km	4.9Ω/M' 16.1Ω/km	.214 5.44	100	66%	15.5	50.9	27.5	90.2
	9805	NEC: CL2	3	See Chart 3 (Tech Info Section)	100 500 1000	30.5 152.4 304.8	4.2 15.5 35.0	1.9 7.0 15.9	64.9Ω/M' 212.9Ω/km	4.2Ω/M' 13.8Ω/km	.222 5.64	100	66%	15.5	50.9	27.5	90.2	
	9806	NEC: CL2	4	See Chart 3 (Tech Info Section)	100 500 1000	30.5 152.4 304.8	4.3 17.5 39.0	2.0 7.9 17.7	64.9Ω/M' 212.9Ω/km	4.0Ω/M' 13.1Ω/km	.237 6.02	100	66%	15.5	50.9	27.5	90.2	
	9807	NEC: CL2	5	See Chart 3 (Tech Info Section)	100 500 1000	30.5 152.4 304.8	4.3 18.0 39.0	2.0 8.2 17.7	64.9Ω/M' 212.9Ω/km	4.2Ω/M' 13.8Ω/km	.240 6.10	100	66%	15.5	50.9	27.5	90.2	
	9808	NEC: CL2	7	See Chart 3 (Tech Info Section)	100 500 1000	30.5 152.4 304.8	4.9 20.5 44.0	2.2 9.3 20.0	64.9Ω/M' 212.9Ω/km	3.7Ω/M' 12.1Ω/km	.256 6.50	100	66%	15.5	50.9	27.5	90.2	
	9809	NEC: CL2	9	See Chart 3 (Tech Info Section)	100 500 1000	30.5 152.4 304.8	5.7 25.0 53.0	2.6 11.3 24.1	64.9Ω/M' 212.9Ω/km	3.1Ω/M' 10.2Ω/km	.290 7.37	100	66%	15.5	50.9	27.5	90.2	
	9812	NEC: CL2	12	See Chart 3 (Tech Info Section)	100 500 1000	30.5 152.4 304.8	6.7 31.0 62.0	3.0 14.1 28.2	64.9Ω/M' 212.9Ω/km	2.8Ω/M' 9.2Ω/km	.319 8.10	100	66%	15.5	50.9	27.5	90.2	
	9813	NEC: CL2	13	See Chart 3 (Tech Info Section)	100 500 1000	30.5 152.4 304.8	7.0 34.0 66.0	3.2 15.5 30.0	64.9Ω/M' 212.9Ω/km	2.2Ω/M' 7.2Ω/km	.336 8.53	100	66%	15.5	50.9	27.5	90.2	
	9819	NEC: CL2	18	See Chart 3 (Tech Info Section)	100 500 1000	30.5 152.4 304.8	8.3 41.0 82.0	3.8 18.6 37.3	64.9Ω/M' 212.9Ω/km	2.0Ω/M' 6.7Ω/km	.365 9.27	100	66%	15.5	50.9	27.5	90.2	
	9825	NEC: CL2	25	See Chart 3 (Tech Info Section)	100 500 1000	30.5 152.4 304.8	9.9 54.5 108.0	4.5 24.8 49.1	64.9Ω/M' 212.9Ω/km	1.9Ω/M' 6.2Ω/km	.429 10.90	100	66%	15.5	50.9	27.5	90.2	
9814	NEC: CL2	31	See Chart 3 (Tech Info Section)	100 500 1000	30.5 152.4 304.8	11.8 64.0 127.0	5.4 29.1 57.7	64.9Ω/M' 212.9Ω/km	2.1Ω/M' 6.9Ω/km	.462 11.73	100	66%	15.5	50.9	27.5	90.2		

DCR = DC Resistance • TC = Tinned Copper

*Capacitance between conductors.

**Capacitance between one conductor and other conductors connected to shield.

Overall Foil/Braid Shield

Low-Capacitance Computer Cables for EIA RS-232 and EIA RS-485 Applications

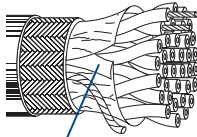
Description	Part No.	UL NEC/ C(UL) CEC Type	No. of Pairs	Color Code	Standard Lengths		Standard Unit Weight		Nom. DCR		Nominal OD		Nom. Imp. (Ω)	Nom. Vel. of Prop.	Nom. Capacitance			
					Ft.	m	Lbs.	kg	Cond.	Shield	Inch	mm			* pF/ Ft.	* pF/ m	** pF/ Ft.	** pF/ m
28 AWG Stranded (7x36) TC Conductors • Overall Beldfoil® (100% Coverage) + TC Braid Shield (65% Coverage) • 28 AWG Stranded TC Drain Wire																		
Datalene® Insulation • Chrome PVC Jacket																		
 <p>Shorting Fold</p>	UL AWM Style 2919 (30V 80°C)	8132	NEC: CL2	2	See Chart 5 (Tech Info Section)	100 500 1000	30.5 152.4 304.8	3.6 14.5 29.0	1.6 6.6 13.2	65.0Ω/M' 213.0Ω/km	5.1Ω/M' 16.6Ω/km	.220 5.59	120	78%	11.0	36.1	20.0	65.6
	8133	NEC: CL2	3	See Chart 5 (Tech Info Section)	100 500 1000	30.5 152.4 304.8	3.8 15.0 34.0	1.7 6.8 15.5	65.0Ω/M' 213.0Ω/km	5.2Ω/M' 17.1Ω/km	.270 6.86	120	78%	11.0	36.1	20.0	65.6	
	8134	NEC: CL2	4	See Chart 5 (Tech Info Section)	100 500 1000	30.5 152.4 304.8	4.3 18.0 39.0	2.0 8.2 17.7	65.0Ω/M' 213.0Ω/km	4.4Ω/M' 14.3Ω/km	.290 7.37	120	78%	11.0	36.1	20.0	65.6	
	8135	NEC: CL2	5	See Chart 5 (Tech Info Section)	100 500 1000	30.5 152.4 304.8	4.6 22.0 42.0	2.1 9.1 19.1	65.0Ω/M' 213.0Ω/km	4.2Ω/M' 13.8Ω/km	.300 7.62	120	78%	11.0	36.1	20.0	65.6	
	8138	NEC: CL2	8	See Chart 5 (Tech Info Section)	100 500 1000	30.5 152.4 304.8	5.6 27.0 52.0	2.5 12.3 23.6	65.0Ω/M' 213.0Ω/km	3.7Ω/M' 12.3Ω/km	.330 8.38	120	78%	11.0	36.1	20.0	65.6	
	8142	NEC: CL2	12.5 (12 pairs + 1 single)	See Chart 5 (Tech Info Section)	100 500 1000	30.5 152.4 304.8	6.8 33.0 66.0	3.1 15.0 29.9	65.0Ω/M' 213.0Ω/km	3.1Ω/M' 10.1Ω/km	.375 9.53	120	78%	11.0	36.1	20.0	65.6	
	8148	NEC: CL2	18	See Chart 5 (Tech Info Section)	100 500 1000	30.5 152.4 304.8	8.5 47.5 92.0	3.9 21.6 41.8	65.0Ω/M' 213.0Ω/km	2.6Ω/M' 8.4Ω/km	.465 11.81	120	78%	11.0	36.1	20.0	65.6	
	8155	NEC: CL2	25	See Chart 5 (Tech Info Section)	100 500 1000	30.5 152.4 304.8	11.1 64.0 121.0	5.0 29.1 55.0	65.0Ω/M' 213.0Ω/km	2.3Ω/M' 7.6Ω/km	.565 14.35	120	78%	11.0	36.1	20.0	65.6	

DCR = DC Resistance • TC = Tinned Copper









*Capacitance between conductors.

**Capacitance between one conductor and other conductors connected to shield.

Datalene insulation features include low dielectric constant and a dissipation factor for high-speed, low-distortion data handling. Physical properties include good crush resistance and light weight.

Overall Foil/Braid Shield

Low-Capacitance Computer Cables for EIA RS-485 Applications
Plenum-Rated and Non-Plenum

Description	Part No.	UL NEC/ C(UL) CEC Type	No. of Pairs	Color Code	Standard Lengths		Standard Unit Weight		Nom. DCR		Nominal OD		Nom. Imp. (Ω)	Nom. Vel. of Prop.	Nom. Capacitance			
					Ft.	m	Lbs.	kg	Cond.	Shield	Inch	mm			* pF/ Ft.	* pF/ m	** pF/ Ft.	** pF/ m
24 AWG Stranded (7x32) TC Conductors • Overall Beldfoil® (100% Coverage) + TC Braid Shield (90% Coverage) • 24 AWG Stranded TC Drain Wire																		
Polyethylene Insulation • Chrome PVC Jacket																		
UL AWM Style 2919 (30V 80°C) DMX 512 	9841	NEC:	1	See	100	30.5	4.3	2.0	24.0Ω/M'	3.4Ω/M'	.232	5.89	120	66%	12.8	42.0	23.0	75.5
		CM		Chart 5	500	152.4	20.0	9.1	78.7Ω/km	11.0Ω/km	For Plenum versions of 9841, see 82841 or 89841.							
		CEC:		(Tech Info	1000	304.8	40.0	18.2										
		CM		Section)														
	9842	NEC:	2	See	100	30.5	5.8	2.6	24.0Ω/M'	2.2Ω/M'	.340	8.64	120	66%	12.8	42.0	23.0	75.5
		CM		Chart 5	500	152.4	29.5	13.4	78.7Ω/km	7.2Ω/km	For Plenum versions of 9842, see 82842.							
		CEC:		(Tech Info	1000	304.8	57.0	25.9										
		CM		Section)														
	9843	NEC:	3	See	100	30.5	7.1	3.2	24.0Ω/M'	2.3Ω/M'	.360	9.14	120	66%	12.8	42.0	23.0	75.5
		CM		Chart 5	500	152.4	34.5	15.7	78.7Ω/km	7.7Ω/km								
		CEC:		(Tech Info	1000	304.8	67.0	30.5										
		CM		Section)														
	9844	NEC:	4	See	500	152.4	43.0	19.5	24.0Ω/M'	2.1Ω/M'	.390	9.91	120	66%	12.8	42.0	23.0	75.5
		CM		Chart 5	1000	304.8	83.0	37.7	78.7Ω/km	6.9Ω/km								
		CEC:		(Tech Info														
		CM		Section)														
Plenum • Foam FEP Insulation • Natural Flamarrrest® Jacket																		
300V RMS 	82841	NEC:	1	See	500	152.4	13.0	6.0	24.0Ω/M'	3.1Ω/M'	.204	5.18	120	76%	12	39.4	22	72.2
		CMP		Chart 5	1000	304.8	26.0	11.8	78.7Ω/km	10.2Ω/km								
		CEC:		(Tech Info														
300V RMS 	82842	NEC:	2	See	500	152.4	19.0	8.6	24.0Ω/M'	2.4Ω/M'	.273	6.93	120	76%	12	39.4	22	72.2
		CMP		Chart 5	1000	304.8	42.0	19.1	78.7Ω/km	7.9Ω/km								
		CEC:		(Tech Info														
300V RMS 	89841	NEC:	1	See	500	152.4	13.5	6.1	24.0Ω/M'	3.1Ω/M'	.202	5.13	120	76%	12	39.4	22	72.2
		CMP		Chart 5	1000	304.8	27.0	12.3	78.7Ω/km	10.2Ω/km								
		CEC:		(Tech Info														
300V RMS 	89842 <small>new</small>	NEC:	2	See	500	152.4	25.5	11.6	24.0Ω/M'	3.1Ω/M'	.305	7.75	120	76%	12	39.4	22	72.2
		CMP		Chart 5	1000	304.8	49.0	22.2	78.7Ω/km	10.2Ω/km								
		CEC:		(Tech Info														

DCR = DC Resistance • TC = Tinned Copper

*Capacitance between conductors.

**Capacitance between one conductor and other conductors connected to shield.

Overall Foil/Braid Shield

Low-Capacitance Computer Cables for EIA RS-232 Applications

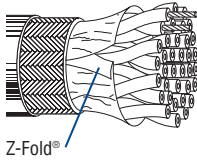
Description	Part No.	UL NEC/ C(UL) CEC Type	No. of Pairs	Color Code	Standard Lengths		Standard Unit Weight		Nom. DCR		Nominal OD		Nom. Imp. (Ω)	Nom. Vel. of Prop.	Nom. Capacitance					
					Ft.	m	Lbs.	kg	Cond.	Shield	Inch	mm			* pF/ Ft.	* pF/ m	** pF/ Ft.	** pF/ m		
24 AWG Stranded (7x32) TC Conductors • Twisted Pairs • Overall Beldfoil® (100% Coverage) + TC Braid Shield (65% Coverage)																				
Semi-rigid PVC Insulation • Chrome PVC Jacket																				
UL AWM Style 2464 (300V 80°C) CSA AWM I A  Z-Fold®	8332	NEC:	2	See	100	30.5	4.1	1.9	24.0Ω/M'	5.4Ω/M'	.250	6.35	75	60%	30	98	50	164		
		CMG		Chart 5	500	152.4	16.5	7.5	78.7Ω/km	17.7Ω/km										
		CEC:		(Tech Info Section)	1000	304.8	37.0	16.8												
			CMG FT4																	
		8333	NEC:	3	See	100	30.5	4.8	2.2	24.0Ω/M'	6.6Ω/M'	.265	6.73	75	60%	30	98	50	164	
	CMG		Chart 5		500	152.4	20.5	9.3	78.7Ω/km	21.7Ω/km										
	CEC:		(Tech Info Section)		1000	304.8	44.0	20.1												
			CMG FT4																	
		8334	NEC:	4	See	100	30.5	5.3	2.4	24.0Ω/M'	4.5Ω/M'	.288	7.32	75	60%	30	98	50	164	
	CMG		Chart 5		500	152.4	22.5	10.2	78.7Ω/km	14.8Ω/km										
	CEC:		(Tech Info Section)		1000	304.8	49.0	22.3												
			CMG FT4																	
		8335	NEC:	5	See	100	30.5	6.0	2.7	24.0Ω/M'	4.6Ω/M'	.295	7.49	75	60%	30	98	50	164	
	CMG		Chart 5		500	152.4	29.5	13.4	78.7Ω/km	15.1Ω/km										
	CEC:		(Tech Info Section)		1000	304.8	57.0	25.9												
		CMG FT4																		
	8336	NEC:	6	See	100	30.5	6.5	3.0	24.0Ω/M'	4.7Ω/M'	.310	7.87	75	60%	30	98	50	164		
CMG		Chart 5		500	152.4	31.5	14.3	78.7Ω/km	15.4Ω/km											
CEC:		(Tech Info Section)		1000	304.8	62.0	28.2													
		CMG FT4																		
	8337	NEC:	7	See	100	30.5	6.8	3.1	24.0Ω/M'	4.7Ω/M'	.321	8.15	75	60%	30	98	50	164		
CMG		Chart 5		500	152.4	33.0	14.9	78.7Ω/km	15.4Ω/km											
CEC:		(Tech Info Section)		1000	304.8	65.0	29.5													
		CMG FT4																		
	8340	NEC:	10	See	100	30.5	9.1	4.1	24.0Ω/M'	3.5Ω/M'	.385	9.78	75	60%	30	98	50	164		
CMG		Chart 5		500	152.4	43.5	19.7	78.7Ω/km	11.5Ω/km											
CEC:		(Tech Info Section)		1000	304.8	90.0	40.9													
		CMG FT4																		
	8342	NEC:	12.5 (12 pairs + 1 single)	See	100	30.5	11.0	5.0	24.0Ω/M'	3.6Ω/M'	.405	10.29	75	60%	30	98	50	164		
CMG		Chart 5		500	152.4	55.0	25.0	78.7Ω/km	11.8Ω/km											
CEC:		(Tech Info Section)		1000	304.8	109.0	49.5													
		CMG FT4																		
	8345	NEC:	15	See	500	152.4	61.5	28.0	24.0Ω/M'	3.2Ω/M'	.445	11.30	75	60%	30	98	50	164		
CMG		Chart 5		1000	304.8	123.0	55.9	78.7Ω/km	10.5Ω/km											
CEC:		(Tech Info Section)																		
		CMG FT4																		
	8348	NEC:	18	See	100	30.5	14.2	6.4	24.0Ω/M'	2.7Ω/M'	.480	12.19	75	60%	30	98	50	164		
CMG		Chart 5		500	152.4	78.5	35.8	78.7Ω/km	8.9Ω/km											
CEC:		(Tech Info Section)		1000	304.8	152.0	69.3													
		CMG FT4																		
	8355	NEC:	25	See	500	152.4	96.5	43.9	24.0Ω/M'	2.5Ω/M'	.550	13.97	75	60%	30	98	50	164		
CMG		Chart 5		1000	304.8	195.0	88.6	78.7Ω/km	8.2Ω/km											
CEC:		(Tech Info Section)																		
		CMG FT4																		

DCR = DC Resistance • TC = Tinned Copper

*Capacitance between conductors.

**Capacitance between one conductor and other conductors connected to shield.

Overall Foil/Braid Shield

Low-Capacitance Computer Cables for EIA RS-232 and EIA RS-422 Applications

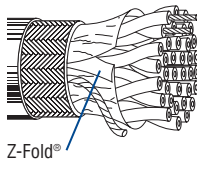
Description	Part No.	UL NEC/ C(UL) CEC Type	No. of Pairs	Color Code	Standard Lengths		Standard Unit Weight		Nom. DCR		Nominal OD		Nom. Imp. (Ω)	Nom. Vel. of Prop.	Nom. Capacitance			
					Ft.	m	Lbs.	kg	Cond.	Shield	Inch	mm			* pF/ Ft.	* pF/ m	** pF/ Ft.	** pF/ m
24 AWG Stranded (7x32) TC Conductors • Twisted Pairs • Overall Beldfoil® (100% Coverage) + TC Braid Shield (65% Coverage) • TC Drain Wire†																		
Polyethylene Insulation • Chrome PVC Jacket																		
 <p>UL AWM Style 2919 (30V 80°C)</p> <p>Z-Fold®</p>	9829	NEC: CM CEC: CM	2	See Chart 5 (Tech Info Section)	100 500 1000	30.5 152.4 304.8	4.7 22.0 43.0	2.1 10.0 19.5	24.0Ω/M' 78.7Ω/km	4.4Ω/M' 14.4Ω/km	.291 7.39	100	66%	15.5	50.9	27.5	90.2	
	9830	NEC: CM CEC: CM	3	See Chart 5 (Tech Info Section)	500 1000	152.4 304.8	26.5 53.0	12.0 24.1	24.0Ω/M' 78.7Ω/km	4.4Ω/M' 14.4Ω/km	.305 7.74	100	66%	15.5	50.9	27.5	90.2	
	9831	NEC: CM CEC: CM	4	See Chart 5 (Tech Info Section)	100 500 1000	30.5 152.4 304.8	6.2 30.0 58.0	2.8 13.6 26.4	24.0Ω/M' 78.7Ω/km	3.9Ω/M' 12.8Ω/km	.330 8.38	100	66%	15.5	50.9	27.5	90.2	
	9832	NEC: CM CEC: CM	5	See Chart 5 (Tech Info Section)	100 500 1000	30.5 152.4 304.8	6.6 32.5 65.0	3.0 14.8 29.5	24.0Ω/M' 78.7Ω/km	3.9Ω/M' 12.8Ω/km	.338 8.59	100	66%	15.5	50.9	27.5	90.2	
	9839	NEC: CM CEC: CM	6	See Chart 5 (Tech Info Section)	500 1000	152.4 304.8	35.5 69.0	16.1 31.4	24.0Ω/M' 78.7Ω/km	2.1Ω/M' 6.9Ω/km	.364 9.25	100	66%	15.5	50.9	27.5	90.2	
	9833	NEC: CM CEC: CM	7	See Chart 5 (Tech Info Section)	500 1000	152.4 304.8	38.5 77.0	17.5 35.0	24.0Ω/M' 78.7Ω/km	3.7Ω/M' 12.1Ω/km	.370 9.40	100	66%	15.5	50.9	27.5	90.2	
	9834	NEC: CM CEC: CM	9	See Chart 5 (Tech Info Section)	500 1000	152.4 304.8	47.0 93.0	21.4 42.3	24.0Ω/M' 78.7Ω/km	3.0Ω/M' 9.8Ω/km	.419 10.64	100	66%	15.5	50.9	27.5	90.2	
	9835	NEC: CM CEC: CM	10	See Chart 5 (Tech Info Section)	500 1000	152.4 304.8	51.5 102.0	23.4 46.4	24.0Ω/M' 78.7Ω/km	2.8Ω/M' 9.2Ω/km	.451 11.46	100	66%	15.5	50.9	27.5	90.2	
	9836	NEC: CM CEC: CM	12	See Chart 5 (Tech Info Section)	100 500 1000	30.5 152.4 304.8	10.4 57.0 114.0	4.7 25.9 51.8	24.0Ω/M' 78.7Ω/km	2.8Ω/M' 9.2Ω/km	.464 11.79	100	66%	15.5	50.9	27.5	90.2	
	9837	NEC: CM CEC: CM	18	See Chart 5 (Tech Info Section)	500 1000	152.4 304.8	87.5 174.0	39.8 79.1	24.0Ω/M' 78.7Ω/km	2.0Ω/M' 6.6Ω/km	.567 14.40	100	66%	15.5	50.9	27.5	90.2	
9838	NEC: CM CEC: CM	25	See Chart 5 (Tech Info Section)	500	152.4	113.0	51.4	24.0Ω/M' 78.7Ω/km	1.9Ω/M' 6.2Ω/km	.670 17.02	100	66%	15.5	50.9	27.5	90.2		

†24 AWG stranded TC drain wire.

DCR = DC Resistance • TC = Tinned Copper

*Capacitance between conductors.

**Capacitance between one conductor and other conductors connected to shield.

Overall Foil/Braid Shield

Low-Capacitance Computer Cables for EIA RS-232 and EIA RS-422 Applications

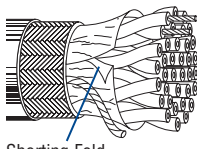
Description	Part No.	UL NEC/ C(UL) CEC Type	No. of Pairs	Color Code	Standard Lengths		Standard Unit Weight		Nom. DCR		Nominal OD		Nom. Imp. (Ω)	Nom. Vel. of Prop.	Nom. Capacitance			
					Ft.	m	Lbs.	kg	Cond.	Shield	Inch	mm			* pF/ Ft.	* pF/ m	** pF/ Ft.	** pF/ m
24 AWG Stranded (7x32) TC Conductors • Twisted Pairs • Overall Beldfoil® (100% Coverage) + TC Braid Shield (65% Coverage) • Drain Wire†																		
Datalene® Insulation • Chrome PVC Jacket																		
 <p>UL AWM Style 2919 (30V 80°C)</p> <p>Shorting Fold</p>	8102	NEC: CM CEC: CM	2	See Chart 5 (Tech Info Section)	100 500 1000 10000	30.5 152.4 304.8 3048.0	4.1 17.0 38.0 380.0	1.9 7.7 17.3 172.7	24.0Ω/M' 78.7Ω/km	4.6Ω/M' 15.1Ω/km	.270 6.86	100	78%	12.5	41	22	72.2	
	8103	NEC: CM CEC: CM	3	See Chart 5 (Tech Info Section)	100 500 1000 10000	30.5 152.4 304.8 3048.0	4.6 19.5 42.0 430.0	2.1 8.9 19.1 195.5	24.0Ω/M' 78.7Ω/km	3.8Ω/M' 12.5Ω/km	.283 7.19	100	78%	12.5	41	22	72.2	
	8104	NEC: CM CEC: CM	4	See Chart 5 (Tech Info Section)	100 500 1000 10000	30.5 152.4 304.8 3048.0	5.1 21.0 46.0 490.0	2.3 9.5 20.9 222.7	24.0Ω/M' 78.7Ω/km	4.1Ω/M' 13.5Ω/km	.302 7.67	100	78%	12.5	41	22	72.2	
	8105	NEC: CM CEC: CM	5	See Chart 5 (Tech Info Section)	100 500 1000 10000	30.5 152.4 304.8 3048.0	5.8 28.0 53.0 53.0	2.6 12.7 24.1 24.1	24.0Ω/M' 78.7Ω/km	4.2Ω/M' 13.8Ω/km	.316 8.03	100	78%	12.5	41	22	72.2	
	8106	NEC: CM CEC: CM	6	See Chart 5 (Tech Info Section)	100 500 1000 10000	30.5 152.4 304.8 3048.0	6.3 30.5 58.0 58.0	2.9 13.9 26.4 26.4	24.0Ω/M' 78.7Ω/km	3.5Ω/M' 11.5Ω/km	.341 8.66	100	78%	12.5	41	22	72.2	
	8107	NEC: CM CEC: CM	7	See Chart 5 (Tech Info Section)	100 500 1000 10000	30.5 152.4 304.8 3048.0	6.8 33.0 63.0 63.0	3.1 15.0 28.6 28.6	24.0Ω/M' 78.7Ω/km	3.5Ω/M' 11.5Ω/km	.341 8.66	100	78%	12.5	41	22	72.2	
	8108	NEC: CM CEC: CM	8	See Chart 5 (Tech Info Section)	100 500 1000 10000	30.5 152.4 304.8 3048.0	7.6 37.5 72.0 72.0	3.5 17.1 32.8 32.8	24.0Ω/M' 78.7Ω/km	2.7Ω/M' 8.9Ω/km	.370 9.40	100	78%	12.5	41	22	72.2	
	8110	NEC: CM CEC: CM	10	See Chart 5 (Tech Info Section)	100 500 1000 10000	30.5 152.4 304.8 3048.0	8.1 45.5 90.0 90.0	3.7 20.7 40.9 40.9	24.0Ω/M' 78.7Ω/km	2.4Ω/M' 7.9Ω/km	.427 10.85	100	78%	12.5	41	22	72.2	
	8112	NEC: CM CEC: CM	12.5 (12 pairs + 1 single)	See Chart 5 (Tech Info Section)	100 500 1000 10000	30.5 152.4 304.8 3048.0	9.2 51.0 101.0 101.0	4.2 23.3 45.9 45.9	24.0Ω/M' 78.7Ω/km	2.4Ω/M' 7.9Ω/km	.440 11.18	100	78%	12.5	41	22	72.2	
	8115	NEC: CM CEC: CM	15	See Chart 5 (Tech Info Section)	500 1000 10000	152.4 304.8 3048.0	63.5 116.0 52.7	28.9 52.7	24.0Ω/M' 78.7Ω/km	2.6Ω/M' 8.5Ω/km	.495 12.57	100	78%	12.5	41	22	72.2	
8118	NEC: CM CEC: CM	18	See Chart 5 (Tech Info Section)	100 500 1000 10000	30.5 152.4 304.8 3048.0	13.3 70.5 144.0 144.0	6.0 32.0 65.5 65.5	24.0Ω/M' 78.7Ω/km	2.1Ω/M' 6.9Ω/km	.537 13.64	100	78%	12.5	41	22	72.2		
8125	NEC: CM CEC: CM	25	See Chart 5 (Tech Info Section)	100 500 1000 10000	30.5 152.4 304.8 3048.0	20.7 98.0 191.0 191.0	9.4 44.5 86.8 86.8	24.0Ω/M' 78.7Ω/km	2.0Ω/M' 6.6Ω/km	.632 16.05	100	78%	12.5	41	22	72.2		

†24 AWG stranded TC drain wire.

DCR = DC Resistance • TC = Tinned Copper

*Capacitance between conductors.

**Capacitance between one conductor and other conductors connected to shield.

Datalene insulation features include low dielectric constant and a dissipation factor for high-speed, low-distortion data handling. Physical properties include good crush resistance and light weight.



Overall Foil/Braid Shield

Low-Capacitance Computer Cables for EIA RS-232 Applications

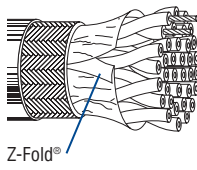
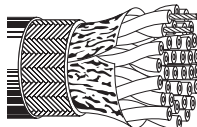
Description	Part No.	UL NEC/ C(UL) CEC Type	No. of Pairs	Color Code	Standard Lengths		Standard Unit Weight		Nom. DCR		Nominal OD		Nom. Imp. (Ω)	Nom. Vel. of Prop.	Nom. Capacitance				
					Ft.	m	Lbs.	kg	Cond.	Shield	Inch	mm			* pF/ Ft.	* pF/ m	** pF/ Ft.	** pF/ m	
22 AWG Stranded (7x30) Tinned Copper Conductors • Twisted Pairs • Overall Beldfoil® (100% Coverage) + TC Braid Shield (65% Coverage)																			
Semi-rigid PVC Insulation • Chrome PVC Jacket																			
UL AWM Style 2464 (300V 80°C)  Z-Fold®	8302	NEC:	2	See	100	30.5	4.5	2.0	15.0Ω/M'	5.7Ω/M'	.260	6.60	70	60%	40	131	72	236	
		CMG		Chart 3	500	152.4	19.0	8.6	49.2Ω/km	18.7Ω/km									
		CEC:		(Tech Info Section)	1000	304.8	41.0	18.6											
			CMG FT4																
		8303	NEC:	3	See	100	30.5	5.2	2.4	15.0Ω/M'	6.2Ω/M'	.270	6.86	70	60%	35	115	63	207
	CMG		Chart 3		500	152.4	25.5	11.6	49.2Ω/km	20.3Ω/km									
	CEC:		(Tech Info Section)		1000	304.8	48.0	21.8											
		CMG FT4																	
	8304	NEC:	4	See	100	30.5	6.7	3.0	15.0Ω/M'	4.9Ω/M'	.320	8.13	70	60%	35	115	63	207	
CMG		Chart 3		500	152.4	32.5	14.7	49.2Ω/km	16.1Ω/km										
CEC:		(Tech Info Section)		1000	304.8	65.0	29.5												
		CMG FT4																	
	8305	NEC:	5	See	100	30.5	7.2	3.3	15.0Ω/M'	4.8Ω/M'	.322	8.18	70	60%	35	115	63	207	
CMG		Chart 3		500	152.4	35.0	15.9	49.2Ω/km	15.7Ω/km										
CEC:		(Tech Info Section)		1000	304.8	67.0	30.4												
		CMG FT4																	
	8306	NEC:	6	See	100	30.5	8.0	3.6	15.0Ω/M'	5.0Ω/M'	.348	8.84	70	60%	35	115	63	207	
CMG		Chart 3		500	152.4	39.5	18.0	49.2Ω/km	16.4Ω/km										
CEC:		(Tech Info Section)		1000	304.8	79.0	35.8												
		CMG FT4																	
	8307	NEC:	7	See	100	30.5	8.6	3.9	15.0Ω/M'	5.0Ω/M'	.348	8.84	70	60%	35	115	63	207	
CMG		Chart 3		500	152.4	42.0	19.0	49.2Ω/km	16.4Ω/km										
CEC:		(Tech Info Section)		1000	304.8	85.0	38.6												
		CMG FT4																	
	8308	NEC:	8	See	100	30.5	10.4	4.7	15.0Ω/M'	4.4Ω/M'	.384	9.75	70	60%	35	115	63	207	
CMG		Chart 3		500	152.4	50.0	22.7	49.2Ω/km	14.4Ω/km										
CEC:		(Tech Info Section)		1000	304.8	101.0	46.0												
		CMG FT4																	
UL AWM Style 2464 (300V 80°C) 	8310	NEC:	10	See	100	30.5	11.1	5.0	15.0Ω/M'	4.1Ω/M'	.440	11.18	70	60%	35	115	63	207	
		CMG		Chart 3	500	152.4	60.5	27.4	49.2Ω/km	13.4Ω/km									
		CEC:		(Tech Info Section)	1000	304.8	121.0	54.9											
			CMG FT4																
		8312	NEC:	12	See	100	30.5	12.9	5.9	15.0Ω/M'	4.2Ω/M'	.455	11.56	70	60%	35	115	63	207
	CMG		Chart 3		500	152.4	72.0	32.8	49.2Ω/km	13.8Ω/km									
	CEC:		(Tech Info Section)		1000	304.8	140.0	63.8											
		CMG FT4																	
	8315	NEC:	15	See	100	30.5	15.7	7.1	15.0Ω/M'	3.8Ω/M'	.502	12.75	70	60%	35	115	63	207	
CMG		Chart 3		500	152.4	85.5	39.0	49.2Ω/km	12.5Ω/km										
CEC:		(Tech Info Section)		1000	304.8	167.0	76.1												
		CMG FT4																	
	8318	NEC:	18	See	100	30.5	17.7	8.0	15.0Ω/M'	3.0Ω/M'	.535	13.59	70	60%	35	115	63	207	
CMG		Chart 3		500	152.4	97.5	44.2	49.2Ω/km	9.8Ω/km										
CEC:		(Tech Info Section)		1000	304.8	196.0	89.1												
		CMG FT4																	
	8325	NEC:	25	See	100	30.5	23.1	10.5	15.0Ω/M'	2.9Ω/M'	.620	15.75	70	60%	35	115	63	207	
CMG		Chart 3		500	152.4	126.0	57.4	49.2Ω/km	9.5Ω/km										
CEC:		(Tech Info Section)		1000	304.8	246.0	112.1												
		CMG FT4																	

DCR = DC Resistance • TC = Tinned Copper

*Capacitance between conductors.

**Capacitance between one conductor and other conductors connected to shield.

Overall Foil/Braid Shield

Computer P.O.S. Cables

Plenum-Rated and Non-Plenum

Description	Part No.	UL NEC/ C(UL) CEC Type	No. of Pairs	Color Code	Standard Lengths		Standard Unit Weight		Nom. DCR		Nominal OD		Nom. Imp. (Ω)	Nom. Vel. of Prop.	Nom. Capacitance			
					Ft.	m	Lbs.	kg	Cond.	Shield	Inch	mm			* pF/ Ft.	* pF/ m	** pF/ Ft.	** pF/ m

22 AWG Solid TC Conductors • Twisted Pairs • Overall Beldfoil® (100% Coverage) + TC Braid Shield (90% Coverage) • TC Drain Wire

Polyethylene Insulation • Black PVC Jacket

UL AWM Style 2582 (150V 60°C)	1268A	NEC: CM CEC: CM	2	Red & Blue, Black & Yellow	1000	304.8	48.0	21.8	16.5Ω/M' 54.1Ω/km	3.7Ω/M' 12.1Ω/km	.270	6.86	100	66%	15.5	50.9	27.5	90.2
----------------------------------	--------------	--------------------------	---	-------------------------------------	------	-------	------	------	----------------------	---------------------	------	------	-----	-----	------	------	------	------



For Plenum version of 1268A, see 1269A.

Plenum • Solid FEP Insulation • Black FEP Jacket

300V RMS, Non-conduit	1269A	NEC: MPP, CMP CEC: MPP, CMP FT6	2	Red & Blue, Black & Yellow	1000†	304.8	48.0	21.8	16.5Ω/M' 54.1Ω/km	2.1Ω/M' 6.9Ω/km	.240	6.10	100	69.5%	15.5	50.9	27.0	88.6
-----------------------	--------------	---	---	-------------------------------------	-------	-------	------	------	----------------------	--------------------	------	------	-----	-------	------	------	------	------



22 AWG Solid TC Conductors • Twisted Pairs • Overall Beldfoil (100% Coverage) + TC Braid Shield (58% Coverage) • TC Drain Wire

Polyethylene Insulation • Black PVC Jacket

UL AWM Style 2582 (150V 60°C)	9855	NEC: CM CEC: CM	2	Red & Blue, Black & Yellow	U-500 500 1000 10000††	U-152.4 152.4 304.8 3048.0	20.0 18.5 40.0 410.0	9.1 8.4 40.0 186.4	16.5Ω/M' 54.1Ω/km	4.2Ω/M' 13.8Ω/km	.270	6.86	100	66%	15.5	50.9	27.5	90.2
----------------------------------	-------------	--------------------------	---	-------------------------------------	---------------------------------	-------------------------------------	-------------------------------	-----------------------------	----------------------	---------------------	------	------	-----	-----	------	------	------	------



For Plenum version of 9855, see 89855.

22 AWG Solid TC Conductors • Twisted Pairs • Overall Beldfoil (100% Coverage) + TC Braid Shield (55% Coverage) + Polyester Tape • Drain Wire

Plenum • Solid FEP Insulation • Black FEP Jacket

300V RMS, Non-conduit	89855	NEC: MPP, CMP CEC: MPP, CMP FT6	2	1 Pair: Red & Blue	500† 1000†	152.4 304.8	22.5 42.0	10.2 19.1	16.5Ω/M' 54.1Ω/km	4.9Ω/M' 16.1Ω/km	.272	6.91	100	69.5%	15.5	50.9	27.0	88.6
-----------------------	--------------	--	---	--------------------------	---------------	----------------	--------------	--------------	----------------------	---------------------	------	------	-----	-------	------	------	------	------



22 AWG Solid BC Conductors • Twisted Pairs • Overall Beldfoil (100% Coverage) + TC Braid Shield (58% Coverage) • TC Drain Wire

Polyethylene Insulation • Black PVC Jacket

UL AWM Style 2919 (30V 80°C)	9696	NEC: CM CEC: CM	2	1 Pair: Blue & White w/Blue Stripe 1 Pair: Orange & White w/Orange Stripe	500 1000	152.4 304.8	23.5 44.0	10.7 20.0	14.2Ω/M' 46.6Ω/km	4.2Ω/M' 13.8Ω/km	.290	7.37	100	66%	16.0	52.5	27.5	90.2
---------------------------------	-------------	--------------------------	---	--	-------------	----------------	--------------	--------------	----------------------	---------------------	------	------	-----	-----	------	------	------	------



For Plenum version of 9696, see 89696.

22 AWG Solid BC Conductors • Twisted Pairs • Overall Beldfoil (100% Coverage) + TC Braid Shield (55% Coverage) • TC Drain Wire

Plenum • Solid FEP Insulation • Black FEP Jacket

300V RMS, Non-conduit	89696	NEC: MPP, CMP CEC: MPP, CMP FT6	2	1 Pair: Blue & White w/Blue Stripe 1 Pair: Orange & White w/Orange Stripe	500† 1000†	152.4 304.8	25.0 46.0	11.4 20.9	16.5Ω/M' 54.1Ω/km	4.2Ω/M' 13.8Ω/km	.262	6.65	100	69.5%	15.5	50.9	27.0	88.6
-----------------------	--------------	--	---	--	---------------	----------------	--------------	--------------	----------------------	---------------------	------	------	-----	-------	------	------	------	------



BC = Bare Copper • DCR = DC Resistance • TC = Tinned Copper

*Capacitance between conductors.

**Capacitance between one conductor and other conductors connected to shield.

† Spools are one piece, but length may vary ±10% from length shown.

†† Final put-up length may vary -10% to +20% from length shown. May contain 2 pieces. Minimum length of any one piece is 1500 ft.

Individually Shielded

Cable Characteristics

Attenuation

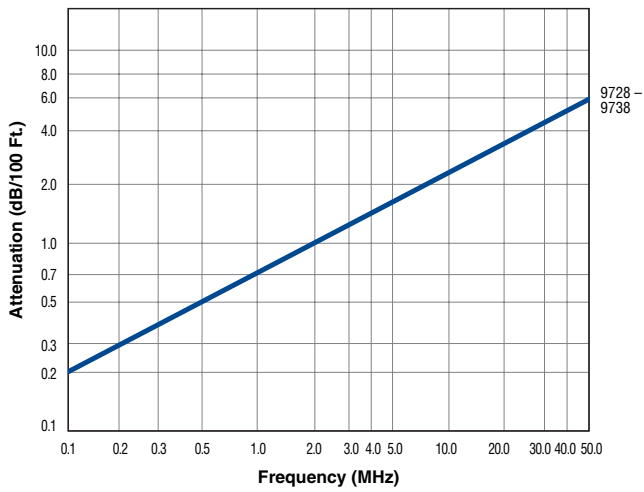

Rise Time

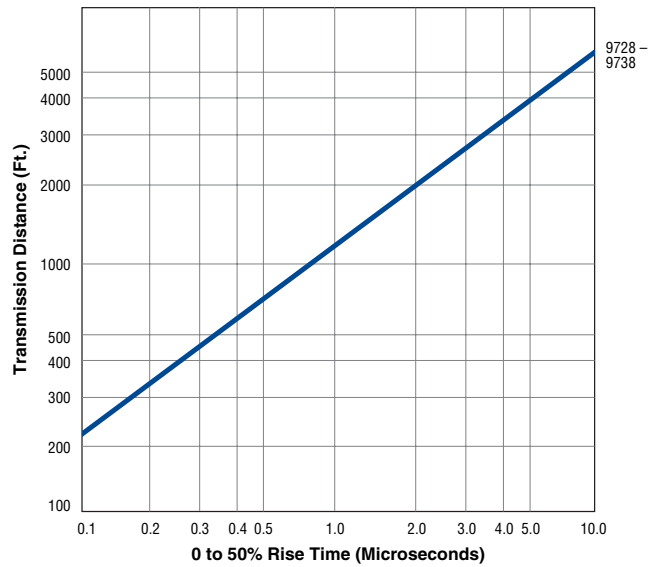

Cables are terminated in their characteristic impedance. Signal source electrical characteristics: 50 ohms and 10% to 90% rise time less than 5 nanoseconds.

Bit Rate

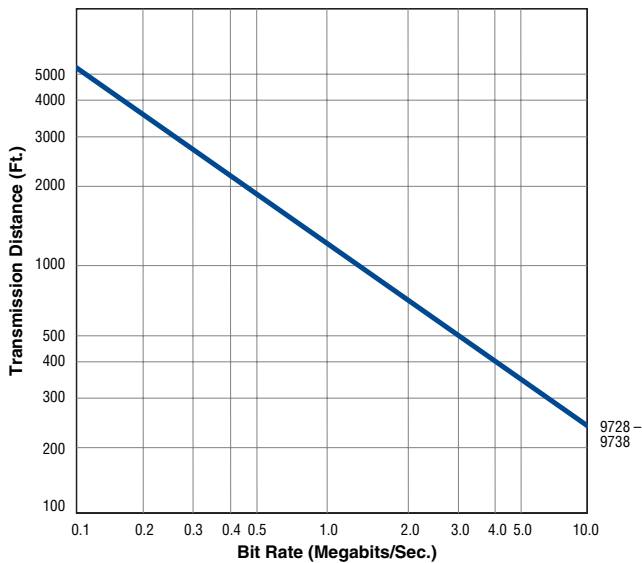

Charts assume 5% peak-to-peak time jitter as determined by eye pattern measurements of pseudorandom NRZ code.

Individually Shielded

Low-Capacitance 100 Ohm Computer Cables for EIA RS-422, and Digital Audio Applications

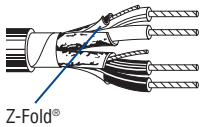
Description	Part No.	UL NEC/ C(UL) CEC Type	No. of Pairs	Color Code	Standard Lengths		Standard Unit Weight		Nom. DCR		Nominal OD		Nom. Imp. (Ω)	Nom. Vel. of Prop.	Nom. Capacitance			
					Ft.	m	Lbs.	kg	Cond.	Shield	Inch	mm			* pF/ Ft.	* pF/ m	** pF/ Ft.	** pF/ m
24 AWG Stranded (7x32) TC Conductors • Twisted Pairs • Individually Shielded w/Beldfoil® (100% Coverage) • 24 AWG Stranded TC Drain Wire																		
Datalene® Insulation • Chrome PVC Jacket																		
UL AWM Style 2493 (300V 60°C)	9729	NEC:	2	See	100	30.5	4.3	2.0	24.0Ω/M'	15.0Ω/M'	.266	6.76	100	76%	12.5	41.0	23.2	76.1
		CM		Chart 3	500	152.4	20.5	9.3	78.7Ω/km	49.2Ω/km	For Plenum version of 9729, see 89729 or 82729.							
	9730	CEC:	3	(Tech Info	1000	304.8	39.0	17.7	24.0Ω/M'	15.0Ω/M'	.334	8.48	100	76%	12.5	41.0	23.2	76.1
		CM		Section)														
	9728	NEC:	4	See	100	30.5	6.0	2.7	24.0Ω/M'	15.0Ω/M'	.363	9.22	100	76%	12.5	41.0	23.2	76.1
		CM		Chart 3	500	152.4	29.0	13.2	78.7Ω/km	49.2Ω/km	For Plenum version of 9728, see 89728.							
	9731	CEC:	6	(Tech Info	1000	304.8	83.0	37.7	24.0Ω/M'	15.0Ω/M'	.421	10.69	100	76%	12.5	41.0	23.2	76.1
		CM		Section)														
	9732	NEC:	9	See	100	30.5	9.9	4.5	24.0Ω/M'	15.0Ω/M'	.488	12.40	100	76%	12.5	41.0	23.2	76.1
		CM		Chart 3	500	152.4	57.0	26.0	78.7Ω/km	49.2Ω/km	For Plenum version of 9732, see 89732.							
	9733	CEC:	11	(Tech Info	1000	304.8	106.0	48.1	24.0Ω/M'	15.0Ω/M'	.575	14.61	100	76%	12.5	41.0	23.2	76.1
		CM		Section)														
	9734	NEC:	12	See	500	152.4	79.5	36.1	24.0Ω/M'	15.0Ω/M'	.575	14.61	100	76%	12.5	41.0	23.2	76.1
		CM		Chart 3	1000	304.8	154.0	70.0	78.7Ω/km	49.2Ω/km								
	9735	CEC:	15	(Tech Info	1000	304.8	185.0	84.1	24.0Ω/M'	15.0Ω/M'	.639	16.23	100	76%	12.5	41.0	23.2	76.1
		CM		Section)														
	9736	NEC:	17	See	500	152.4	103.5	47.0	24.0Ω/M'	15.0Ω/M'	.671	17.04	100	76%	12.5	41.0	23.2	76.1
		CM		Chart 3	1000	304.8	210.0	95.5	78.7Ω/km	49.2Ω/km								
	9737	CEC:	19	(Tech Info	1000	304.8	231.0	105.0	24.0Ω/M'	15.0Ω/M'	.671	17.04	100	76%	12.5	41.0	23.2	76.1
		CM		Section)														
	9738	NEC:	27	See	1000	304.8	334.0	151.8	24.0Ω/M'	15.0Ω/M'	.797	20.24	100	76%	12.5	41.0	23.2	76.1
		CM		Chart 3	10000†	3048.0	334.0	151.8	78.7Ω/km	49.2Ω/km								
		CEC:		(Tech Info														
		CM		Section)														

DCR = DC Resistance • TC = Tinned Copper

*Capacitance between conductors.

**Capacitance between one conductor and other conductors connected to shield.

† Final put-up length may vary -10% to +20% from length shown. May contain 2 pieces. Minimum length of any one piece is 1500 ft.

See Attenuation, Rise Time and Bit Rate Data for this series on page 5.34.

Datalene insulation features include low dielectric constant and a dissipation factor for high-speed, low-distortion data handling. Physical properties include good crush resistance and light weight.



Individually Shielded

Low-Capacitance Computer Cables for EIA RS-232, EIA RS-422, and Digital Audio Applications
Plenum-Rated

Description	Part No.	UL NEC/ C(UL) CEC Type	No. of Pairs	Color Code	Standard Lengths		Standard Unit Weight		Nom. DCR		Nominal OD		Nom. Imp. (Ω)	Nom. Vel. of Prop.	Nom. Capacitance			
					Ft.	m	Lbs.	kg	Cond.	Shield	Inch	mm			* pF/ Ft.	* pF/ m	** pF/ Ft.	** pF/ m

24 AWG Stranded (7x32) TC Conductors • Twisted Pairs • Individually Shielded w/Beldfoil® (100% Coverage) • 24 AWG Stranded TC Drain Wire

Plenum • Foam FEP Insulation • Gray Fluorocopolymer Jacket

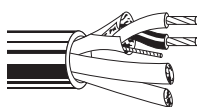
	300V RMS	89729	NEC: CMP CEC: CMP FT6	2	See Chart 5 (Tech Info Section)	500 1000	152.4 304.8	17.0 31.0	7.7 14.1	23.3Ω/M' 76.4Ω/km	14.4Ω/M' 47.2Ω/km	.261 6.63	100	76%	13.5	44	22.5	73.8
		89730	NEC: CMP CEC: CMP FT6	3	See Chart 5 (Tech Info Section)	500 1000	152.4 304.8	21.5 40.0	9.8 18.2	23.3Ω/M' 76.4Ω/km	14.4Ω/M' 47.2Ω/km	.278 7.06	100	76%	13.5	44	22.5	73.8
		89728	NEC: CMP CEC: CMP FT6	4	See Chart 5 (Tech Info Section)	500 1000	152.4 304.8	26.5 50.0	12.0 22.7	23.3Ω/M' 76.4Ω/km	14.4Ω/M' 47.2Ω/km	.307 7.80	100	76%	13.5	44	22.5	73.8
		89731	NEC: CMP CEC: CMP FT6	6	See Chart 5 (Tech Info Section)	500 1000†	152.4 304.8	35.0 71.0	15.9 32.3	23.3Ω/M' 76.4Ω/km	14.4Ω/M' 47.2Ω/km	.361 9.17	100	76%	13.5	44	22.5	73.8
		89732	NEC: CMP CEC: CMP FT6	9	See Chart 5 (Tech Info Section)	1000	304.8	108.0	49.0	23.3Ω/M' 76.4Ω/km	14.4Ω/M' 47.2Ω/km	.429 10.90	100	76%	13.5	44	22.5	73.8

Plenum • Foam FEP Insulation • Natural Flamarrest® Jacket

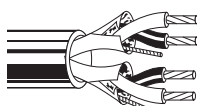
	300V RMS	82729	NEC: CMP CEC: CMP FT6	2	See Chart 5 (Tech Info Section)	U-1000 1000	U-304.8 304.8	26.0 28.0	11.8 12.7	23.3Ω/M' 76.4Ω/km	14.4Ω/M' 47.2Ω/km	.255 6.48	100	76%	13.5	44	22.5	73.8
--	----------	--------------	--------------------------------	---	--	----------------	------------------	--------------	--------------	----------------------	----------------------	--------------	-----	-----	------	----	------	------

DCR = DC Resistance • TC = Tinned Copper

*Capacitance between conductors.
**Capacitance between one conductor and other conductors connected to shield.
† Spools are one piece, but length may vary ±10% from length shown.

Individually Shielded

Audio, Control and Instrumentation Cables

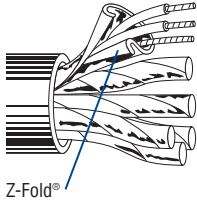
Description	Part No.	UL NEC/ C(UL) CEC Type	No. of Pairs	Color Code	Standard Lengths		Standard Unit Weight		Nom. DCR		Nominal OD		Nom. Imp. (Ω)	Nom. Vel. of Prop.	Nom. Capacitance			
					Ft.	m	Lbs.	kg	Cond.	Shield	Inch	mm			* pF/ Ft.	* pF/ m	** pF/ Ft.	** pF/ m
24 AWG Stranded (7x32) TC Conductors • Twisted Pairs • Individually Shielded w/Beldfoil® (100% Coverage) • 24 AWG Stranded TC Drain Wire																		
Polyethylene Insulation • Chrome PVC Jacket																		
 <p>Z-Fold®</p>	9990	NEC:	3	See Chart 3 (Tech Info Section)	500	152.4	16.0	7.3	24.0Ω/M'	18.0Ω/M'	.255	6.48	60	66%	25	82	47	154
		CM			1000	304.8	36.0	16.4	78.7Ω/km	59.1Ω/km								
		CEC:																
		CM																
	9991	NEC:	6	See Chart 3 (Tech Info Section)	100	30.5	6.7	3.1	24.0Ω/M'	18.0Ω/M'	.330	8.38	60	66%	25	82	47	154
CM	500	152.4			32.5	14.7	78.7Ω/km	59.1Ω/km										
CEC:	1000	304.8			62.0	28.3												
CM																		
	9992	NEC:	9	See Chart 3 (Tech Info Section)	100	30.5	8.8	4.0	24.0Ω/M'	18.0Ω/M'	.383	9.73	60	66%	25	82	47	154
CM	500	152.4			42.5	19.3	78.7Ω/km	59.1Ω/km										
CEC:	1000	304.8			86.0	39.1												
CM																		
	9993	NEC:	12	See Chart 3 (Tech Info Section)	100	30.5	9.8	4.5	24.0Ω/M'	18.0Ω/M'	.428	10.87	60	66%	25	82	47	154
CM	500	152.4			107.0	48.6	78.7Ω/km	59.1Ω/km										
CEC:	1000	304.8			107.0	48.6												
CM																		
	9995	NEC:	25	See Chart 3 (Tech Info Section)	100	30.5	21.2	9.7	24.0Ω/M'	18.0Ω/M'	.636	16.15	60	66%	25	82	47	154
CM	500	152.4			116.0	52.7	78.7Ω/km	59.1Ω/km										
CEC:	1000	304.8			228.0	103.6												
CM																		

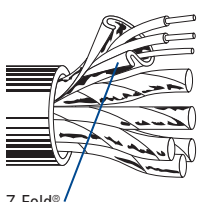
Description	Part No.	UL NEC/ C(UL) CEC Type	No. of Pairs	Color Code	Standard Lengths		Standard Unit Weight		Insulation Thickness		Jacket Thickness		Nominal OD		Nominal Capacitance						
					Ft.	m	Lbs.	kg	Inch	mm	Inch	mm	Inch	mm	* pF/ Ft.	* pF/ m	** pF/ Ft.	** pF/ m			
22 AWG Solid Conductors • TC • Twisted Pairs • Individually Shielded w/ Beldfoil (100% Coverage) • 22 AWG Solid TC Drain Wire																					
PVC Insulation • Overall Chrome PVC Jacket																					
 <p>Z-Fold®</p>	8767	NEC:	3	See Chart 3 (Tech Info Section)	U-500	U-152.4	22.5	10.3	.013	.33	.037	.94	.279	7.10	40	131	77	253			
		MPG, CMG			500	152.4	23.0	10.5													
		CEC:			1000	304.8	46.0	21.0													
		MPG, CMG FT4																			
	8768	NEC:	6	See Chart 3 (Tech Info Section)	500	152.4	46.5	21.1	.013	.33	.037	.94	.379	9.60	40	131	77	253			
MPG, CMG	500	152.4			46.5	21.1															
CEC:	1000	304.8			92.0	41.8															
MPG, CMG FT4																					
	8764	NEC:	9	See Chart 3 (Tech Info Section)	1000	304.8	122.0	55.5	.013	.33	.040	1.02	.425	10.80	40	131	77	253			
MPG, CMG	1000	304.8			122.0	55.5															
CEC:	1000	304.8			122.0	55.5															
MPG, CMG FT4																					
	8765	NEC:	11	See Chart 3 (Tech Info Section)	500	152.4	76.5	34.8	.013	.33	.040	1.02	.470	11.90	40	131	77	253			
MPG, CMG	500	152.4			76.5	34.8															
CEC:	1000	304.8			149.0	67.7															
MPG, CMG FT4																					
	8766	NEC:	15	See Chart 3 (Tech Info Section)	500	152.4	101.5	46.1	.013	.33	.045	1.14	.525	13.30	40	131	77	253			
MPG, CMG	500	152.4			101.5	46.1															
CEC:	1000	304.8			196.0	89.1															
MPG, CMG FT4																					

DCR = DC Resistance • TC = Tinned Copper

*Capacitance between conductors.

**Capacitance between one conductor and other conductors connected to shield.

Individually Shielded

Audio, Control and Instrumentation Cables
Plenum-Rated and Non-Plenum

Description	Part No.	UL NEC/ C(UL) CEC Type	No. of Pairs	Color Code	Standard Lengths		Standard Unit Weight		Nom. DCR		Nominal OD		Nom. Imp. (Ω)	Nom. Vel. of Prop.	Nom. Capacitance			
					Ft.	m	Lbs.	kg	Cond.	Shield	Inch	mm			* pF/ Ft.	* pF/ m	** pF/ Ft.	** pF/ m

22 AWG Stranded (7x30) TC Conductors • Twisted Pairs • Individually Shielded w/Beldfoil® (100% Coverage) • 22 AWG Stranded TC Drain Wire

Semi-rigid PVC Insulation • Pale Fawn Beige PVC Jacket (Shielded Pairs Parallel under Jacket)

 <p>UL AWM Style 2464 (300V 80°C)</p> <p>Z-Fold®</p>	9406	NEC:	2	Black & White,	100	30.5	3.8	1.7	15.0Ω/M'	13.0Ω/M'	.173	4.39	50	60%	50	164	95	312
		CEC:			U-500	U-152.4	16.5	7.5	49.2Ω/km	42.7Ω/km	x	x						
		CMG FT4			500	152.4	17.0	7.7			.280	7.11						
					U-1000	U-304.8	32.0	14.5										
					1000	304.8	33.0	15.0										

22 AWG Stranded (7x30) TC Conductors • Twisted Pairs • Individually Shielded w/Beldfoil (100% Coverage) • 24 AWG Stranded TC Drain Wire

Polypropylene Insulation • Chrome PVC Jacket (Pairs Cabled on Common Axis to Reduce Diameter)

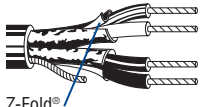
 <p>300V RMS 60°C</p> <p>Z-Fold®</p>	8723	NEC:	2	Red & Black,	100	30.5	2.3	1.0	15.0Ω/M'	16.6Ω/M'	.160	4.06	45	66%	35	115	62	203
		CEC:			U-500	U-152.4	10.5	4.8	49.2Ω/km	54.5Ω/km								
		CM			500	152.4	10.0	4.5										
					U-1000	U-304.8	20.0	9.1										
					1000	304.8	20.0	9.1										
					1640	499.9	32.8	14.9										
					U-2000	U-609.6	38.0	17.2										
					2000	609.6	40.0	18.2										
					3280	999.7	65.6	29.8										
					5000	1524.0	95.0	43.2										
	10000	3048.0	200.0	90.9														

For Plenum versions of 8723, see 88723, 87723 or 82723.

Polypropylene Insulation • Black Low-Smoke, Zero-Halogen Jacket (Pairs Cabled on Common Axis to Reduce Diameter)

 <p>300V RMS 60°C</p> <p>Z-Fold®</p>	8723SB	NEC:	2	Red & Black,	1000	304.8	26.0	11.8	14.7Ω/M'	15.0Ω/M'	.196	4.98	45	66%	35	115	62	203
		CEC:			U-1000	U-304.8	20.0	9.1	48.2Ω/km	49.2Ω/km								
		CMG-LS FT4			1000	304.8	20.0	9.1										
		Limited Smoke																

Plenum • FEP Insulation • Natural Flammarrest® Jacket (Pairs Cabled on Common Axis to Reduce Diameter)

 <p>300V RMS, Non-conduit</p> <p>Z-Fold®</p>	82723	NEC:	2	Red & Black,	U-500†	U-152.4	10.5	4.8	14.7Ω/M'	16.6Ω/M'	.153	3.89	36	62%	43	141	75	246
		CEC:			U-1000	U-304.8	20.0	9.1	48.2Ω/km	54.5Ω/km								
		CMP FT6			1000†	304.8	19.0	8.6										
					U-2000†	U-609.6	40.0	18.1										

Plenum • FEP Insulation • Red FEP Jacket (Pairs Cabled on Common Axis to Reduce Diameter)

 <p>300V RMS, Non-conduit</p> <p>Z-Fold®</p>	88723	NEC:	2	Red & Black,	100†	30.5	3.4	1.5	16.0Ω/M'	14.7Ω/M'	.148	3.76	40	69%	35	115	67	220
		CEC:			500†	152.4	11.0	5.0	52.5Ω/km	48.2Ω/km								
		CMP FT6			1000†	304.8	19.0	8.6										

Plenum • FEP Insulation • Red Fluorocopolymer Jacket (Pairs Cabled on Common Axis to Reduce Diameter)

 <p>300V RMS, Non-conduit</p> <p>Z-Fold®</p>	87723	NEC:	2	Red & Black,	500†	152.4	11.0	5.0	14.7Ω/M'	15.0Ω/M'	.148	3.76	40	69%	35	115	67	220
		CEC:			1000†	304.8	20.0	9.1	48.2Ω/km	49.2Ω/km								
		CMP FT6																

DCR = DC Resistance • FEP = Fluorinated Ethylene Propylene • TC = Tinned Copper

*Capacitance between conductors.

**Capacitance between one conductor and other conductors connected to shield.

† Spools and/or UnReel® cartons are one piece, but length may vary ±10% for spools and ±5% for UnReel from length show.



Individually Shielded

Cable Characteristics

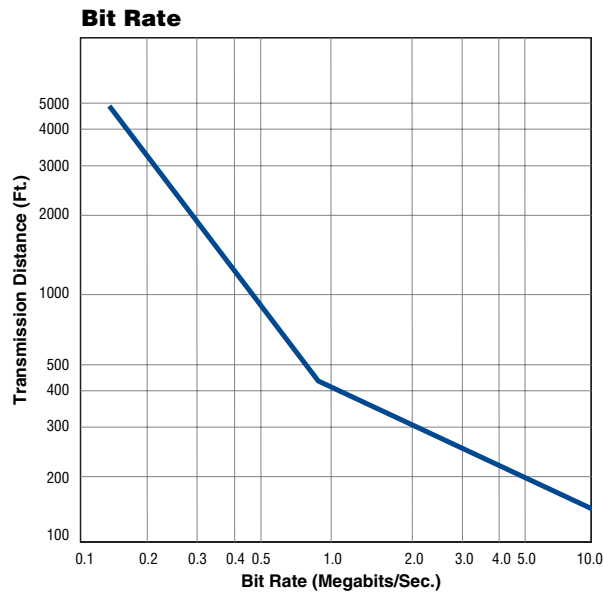
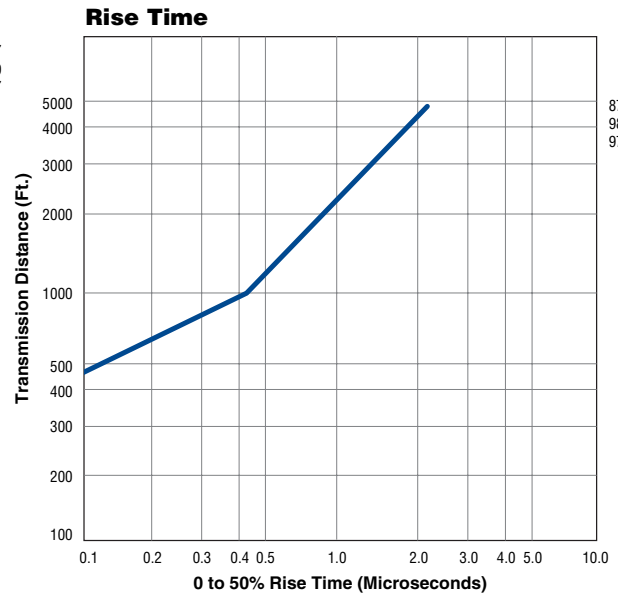
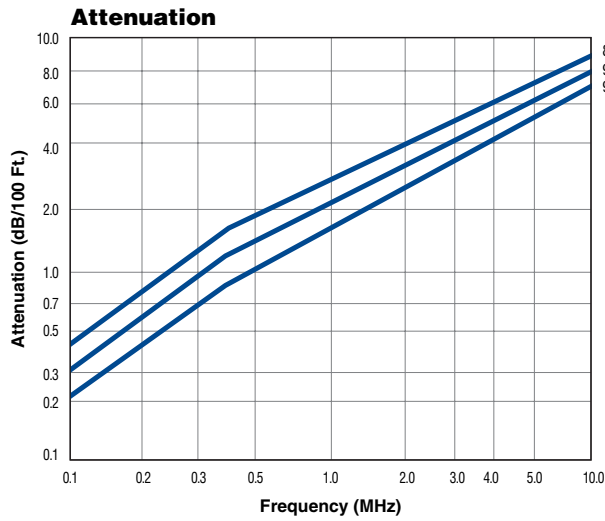

Recommended for audio, pulse, and radio frequency applications requiring superior circuit isolation.

Insulation resistance between shields:
100 megohms/M' nom.

Capacitance between adjacent shields:
115 pF/ft. nom.

Working voltage between adjacent shields:
50 volts max.

Individually Shielded

Audio, Control and Instrumentation Cables

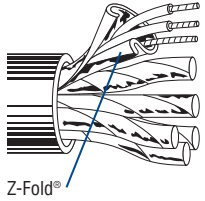
Description	Part No.	UL NEC/ C(UL) CEC Type	No. of Pairs	Color Code	Standard Lengths		Standard Unit Weight		Nom. DCR		Nominal OD		Nom. Imp. (Ω)	Nom. Vel. of Prop.	Nom. Capacitance			
					Ft.	m	Lbs.	kg	Cond.	Shield	Inch	mm			* pF/ Ft.	* pF/ m	** pF/ Ft.	** pF/ m
22 AWG Stranded (7x30) TC Conductors • Twisted Pairs • Individually Shielded w/Beldfoil® (100% Coverage) • 22 AWG Stranded TC Drain Wire																		
Polypropylene Insulation • Chrome PVC Jacket																		
 <p>UL AWM Style 2919 (30V 80°C)</p> <p>Z-Fold®</p>	8777	NEC:	3	See	100	30.5	4.7	2.1	15.0Ω/M'	10.6Ω/M'	.273	6.93	50	66%	30	98	55	180
		CM		Chart 3	250	76.2	10.0	4.5	49.2Ω/km	34.8Ω/km								
		CEC:		(Tech Info	U-500	U-152.4	21.0	9.5										
		CM		Section)	500	152.4	20.0	9.1										
					U-1000	U-304.8	41.0	18.6										
					1000	304.8	44.0	20.0										
					1640	499.9	70.5	32.0										
					3280	999.7	141.0	64.0										
					5000	1524.0	215.0	97.6										
					10000††	3048.0	460.0	208.8										
														For Plenum versions of 8777, see 88777, 87777 or 82777.				
	8778	NEC:	6	See	100	30.5	8.4	3.8	15.0Ω/M'	10.6Ω/M'	.362	9.19	50	66%	30	98	55	180
		CM		Chart 3	250	76.2	19.0	8.6	49.2Ω/km	34.8Ω/km								
		CEC:		(Tech Info	500	152.4	43.0	19.5										
		CM		Section)	1000	304.8	83.0	37.7										
	8774	NEC:	9	See	100	30.5	11.5	5.2	15.0Ω/M'	10.6Ω/M'	.417	10.59	50	66%	30	98	55	180
		CM		Chart 3	250	76.2	29.5	13.4	49.2Ω/km	34.8Ω/km								
		CEC:		(Tech Info	500	152.4	57.5	26.1										
		CM		Section)	1000	304.8	113.0	51.3										
	8775	NEC:	11	See	100	30.5	12.1	5.5	15.0Ω/M'	10.6Ω/M'	.464	11.79	50	66%	30	98	55	180
		CM		Chart 3	500	152.4	65.5	29.7	49.2Ω/km	34.8Ω/km								
		CEC:		(Tech Info	1000	304.8	130.0	59.0										
		CM		Section)														
	9768	NEC:	12	See	100	30.5	13.2	6.0	15.0Ω/M'	10.6Ω/M'	.464	11.79	50	66%	30	98	55	180
		CM		Chart 3	250	76.2	36.5	16.5	49.2Ω/km	34.8Ω/km								
		CEC:		(Tech Info	500	152.4	73.5	33.4										
		CM		Section)	1000	304.8	143.0	65.0										
	8776	NEC:	15	See	100	30.5	17.8	8.1	15.0Ω/M'	10.6Ω/M'	.548	13.92	50	66%	30	98	55	180
		CM		Chart 3	250	76.2	49.5	22.5	49.2Ω/km	34.8Ω/km								
		CEC:		(Tech Info	500	152.4	98.0	44.5										
		CM		Section)	1000	304.8	197.0	89.5										
	9769	NEC:	17	See	100	30.5	20.0	9.1	15.0Ω/M'	10.6Ω/M'	.577	14.66	50	66%	30	98	55	180
		CM		Chart 3	500	152.4	109.0	49.5	49.2Ω/km	34.8Ω/km								
		CEC:		(Tech Info	1000	304.8	215.0	97.7										
		CM		Section)														
	8769	NEC:	19	See	100	30.5	22.9	10.4	15.0Ω/M'	10.6Ω/M'	.603	15.32	50	66%	30	98	55	180
		CM		Chart 3	500	152.4	123.0	55.8	49.2Ω/km	34.8Ω/km								
		CEC:		(Tech Info	1000	304.8	244.0	110.8										
		CM		Section)														
	8773	NEC:	27	See	100	30.5	33.9	15.4	15.0Ω/M'	10.6Ω/M'	.709	18.00	50	66%	30	98	55	180
		CM		Chart 3	250†	76.2	83.8	38.0	49.2Ω/km	34.8Ω/km								
		CEC:		(Tech Info	500	152.4	163.0	74.0										
		CM		Section)	1000	304.8	341.0	154.8										
	9767	NEC:	37	See	500†	152.4	224.0	101.8	15.0Ω/M'	10.6Ω/M'	.800	20.32	50	66%	30	98	55	180
		CM		Chart 3	1000†	304.8	481.0	218.6	49.2Ω/km	34.8Ω/km								
		CEC:		(Tech Info														
		CM		Section)														

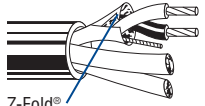
Polypropylene Insulation • Black Low-Smoke, Zero-Halogen Jacket																		
 <p>U300V RMS, Non-conduit</p> <p>Z-Fold®</p>	8777SB	NEC:	3	See	U-500†	U-152.4	19.5	8.9	15.0Ω/M'	10.6Ω/M'	.273	6.93	50	66%	30	98	55	180
		new CMG-LS		Chart 3	U-1000	U-304.8	38.0	17.3	49.2Ω/km	34.8Ω/km								
		CEC:		(Tech Info	1000†	304.8	39.0	17.7										
		CMG-LS FT4	(Section)															
		Limited Smoke																

DCR = DC Resistance • TC = Tinned Copper

See Attenuation, Rise Time and Bit Rate Data for this series on page 5.39.

*Capacitance between conductors.

**Capacitance between one conductor and other conductors connected to shield.

† Spools are one piece, but length may vary -0 to +20% from length shown.

†† Final put-up length may vary -10% to +20% from length shown. May contain 2 pieces. Minimum length of any one piece is 1500 ft.



Individually Shielded

Audio, Control and Instrumentation Cables
Plenum-Rated and Non-Plenum

Description	Part No.	UL NEC/ C(UL) CEC Type	No. of Pairs	Color Code	Standard Lengths		Standard Unit Weight		Nom. DCR		Nominal OD		Nom. Imp. (Ω)	Nom. Vel. of Prop.	Nom. Capacitance			
					Ft.	m	Lbs.	kg	Cond.	Shield	Inch	mm			* pF/ Ft.	* pF/ m	** pF/ Ft.	** pF/ m

22 AWG Stranded (7x30) TC Conductors • Twisted Pairs • Individually Shielded w/Beldfoil® (100% Coverage) • 22 AWG Stranded TC Drain Wire

Plenum • FEP Insulation • Natural Flamarrest® Jacket

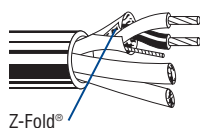
 <p>Z-Fold®</p>	82777	NEC:	3	See	U-500†	U-152.4	19.5	8.9	14.7Ω/M'	11.3Ω/M'	.237	6.02	46	62%	35	115	76	249	
		CMP		Chart 3	U-1000	U-304.8	38.0	17.3	48.2Ω/km	37.1Ω/km									
		CEC:		(Tech Info	1000†	304.8	39.0	17.7											
		CMP FT6		Section)															
	82778	NEC:	6	See	1000†	304.8	71.0	32.2	14.7Ω/M'	11.3Ω/M'	.314	7.98	46	62%	35	115	76	249	
CMP			Chart 3						48.2Ω/km	37.1Ω/km									
CEC:			(Tech Info																
CMP FT6			Section)																

Plenum • FEP Insulation • Red FEP Jacket

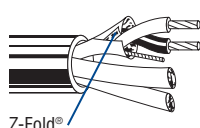
 <p>Z-Fold®</p>	88777	NEC:	3	See	100	30.5	6.0	2.7	14.7Ω/M'	11.3Ω/M'	.234	5.94	50	69%	31	102	67	220	
		CMP		Chart 3	500†	152.4	19.0	8.6	48.2Ω/km	37.1Ω/km									
		CEC:		(Tech Info	1000†	304.8	42.0	19.1											
		CMP FT6		Section)															
	88778	NEC:	6	See	100	30.5	7.0	3.2	14.7Ω/M'	11.3Ω/M'	.309	7.85	50	69%	31	102	67	220	
CMP			Chart 3	500†	152.4	38.5	17.4	48.2Ω/km	37.1Ω/km										
CEC:			(Tech Info	1000†	304.8	75.0	34.1												
CMP FT6			Section)																

Plenum • FEP Insulation • Red Fluorocopolymer Jacket

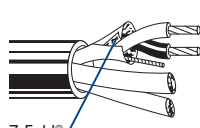
 <p>Z-Fold®</p>	87777	NEC:	3	See	500†	152.4	18.0	8.2	14.7Ω/M'	11.3Ω/M'	.234	5.94	50	69%	31	102	67	220	
		CMP		Chart 3	1000†	304.8	40.0	18.2	48.2Ω/km	37.1Ω/km									
		CEC:		(Tech Info															
		CMP FT6		Section)															
	87778	NEC:	6	See	500†	152.4	37.5	17.0	14.7Ω/M'	11.3Ω/M'	.309	7.85	50	69%	31	102	67	220	
CMP			Chart 3	1000†	304.8	73.0	33.2	48.2Ω/km	37.1Ω/km										
CEC:			(Tech Info																
CMP FT6			Section)																

20 AWG Stranded (7x28) TC Conductors • Twisted Pairs • Individually Shielded w/Beldfoil (100% Coverage) • 22 AWG Stranded TC Drain Wire

Semi-rigid PVC Insulation • Overall Chrome PVC Jacket

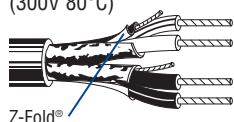
 <p>Z-Fold®</p>	9402	NEC:	2	Red &	U-500	U-152.4	26.0	11.8	—	—	.300	7.62	—	—	55	180	95	312
		CMG		Black,	1000	304.8	52.0	23.7										
		CEC:		Green &														
		CMG FT4		White														

Insulation Thickness
.010 .25
Jacket Thickness
.041 1.04

20 AWG Stranded (10x30) TC Conductors • Twisted Pairs • Individually Shielded w/Beldfoil (100% Coverage) • 22 AWG Stranded TC Drain Wire

Polypropylene Insulation • Black High-density Polyethylene Jacket

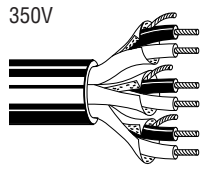
	9883		3	See	500	152.4	28.5	12.9	6.4Ω/M'	11.2Ω/M'	.340	8.64	50	66%	30	98	55	180
				Chart 3	1000	304.8	57.0	25.9	21.0Ω/km	36.8Ω/km								
				(Tech Info														
				Section)														
	9886		6	See	500	152.4	56.0	25.4	6.4Ω/M'	11.2Ω/M'	.455	11.56	50	66%	30	98	55	180
			Chart 3	1000	304.8	108.0	49.0	21.0Ω/km	36.8Ω/km									
			(Tech Info															
			Section)															

DCR = DC Resistance • TC = Tinned Copper

*Capacitance between conductors.

**Capacitance between one conductor and other conductors connected to shield.

† Spools and/or UnReel® cartons are one piece, but length may vary ±10% for spools and ±5% for UnReel from length shown.

Individually Shielded

Audio, Control and Instrumentation Cables

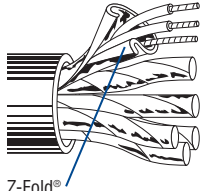
Description	Part No.	UL NEC/ C(UL) CEC Type	No. of Pairs	Color Code	Standard Lengths		Standard Unit Weight		Nom. DCR		Nominal OD		Nom. Imp. (Ω)	Nom. Vel. of Prop.	Nom. Capacitance			
					Ft.	m	Lbs.	kg	Cond.	Shield	Inch	mm			* pF/ Ft.	* pF/ m	** pF/ Ft.	** pF/ m
20 AWG Stranded (7x28) TC Conductors • Twisted Pairs • Individually Shielded w/Beldfoil® (100% Coverage) • 22 AWG Stranded TC Drain Wire																		
Polypropylene Insulation • Overall Chrome PVC Jacket																		
 <p>Z-Fold®</p>	9873	NEC:	3	See Chart 3	100	30.5	6.6	3.0	10.5Ω/M'	14.0Ω/M'	.341	8.66	50	66%	30	98	55	180
		CM			250	76.2	14.5	6.6	34.4Ω/km	45.9Ω/km								
		CEC:			(Tech Info	500	152.4	32.5	14.8									
		CM			Section)	1000	304.8	58.0	26.3									
	9874	NEC:	6	See Chart 3	100	30.5	10.3	4.7	10.5Ω/M'	11.3Ω/M'	.445	11.30	50	66%	30	98	55	180
		CM			250	76.2	29.0	13.2	34.4Ω/km	37.1Ω/km								
		CEC:			(Tech Info	500	152.4	56.5	25.7									
		CM			Section)	1000	304.8	113.0	51.3									
	9875	NEC:	9	See Chart 3	100	30.5	17.7	8.1	10.5Ω/M'	11.3Ω/M'	.555	14.10	50	66%	30	98	55	180
		CM			500	152.4	97.0	44.0	34.4Ω/km	37.1Ω/km								
CEC:		(Tech Info			1000	304.8	187.0	88.4										
CM		Section)																
9876	NEC:	11	See Chart 3	1000	304.8	220.0	100.0	10.5Ω/M'	11.3Ω/M'	.600	15.24	50	66%	30	98	55	180	
	CM						34.4Ω/km	37.1Ω/km										
	CEC:			(Tech Info														
	CM			Section)														
9877	NEC:	12	See Chart 3	100	30.5	22.1	10.1	10.5Ω/M'	11.3Ω/M'	.617	15.67	50	66%	30	98	55	180	
	CM			500	152.4	119.0	54.1	34.4Ω/km	37.1Ω/km									
	CEC:			(Tech Info	1000	304.8	237.0	107.7										
	CM			Section)														
9879	NEC:	15	See Chart 3	500	152.4	146.0	66.4	10.5Ω/M'	11.3Ω/M'	.689	17.50	50	66%	30	98	55	180	
	CM			1000	304.8	296.0	134.5	34.4Ω/km	37.1Ω/km									
	CEC:			(Tech Info														
	CM			Section)														

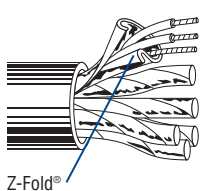
18 AWG Stranded (19x30) TC Conductors • Twisted Pairs • Individually Shielded w/Beldfoil (100% Coverage) • 20 AWG Stranded TC Drain Wire																		
Polypropylene Insulation • Chrome PVC Jacket																		
 <p>Z-Fold®</p>	9773	NEC:	3	See Chart 3	100	30.5	10.8	4.9	6.4Ω/M'	8.3Ω/M'	.404	10.26	50	66%	30	98	55	180
		CM			500	152.4	52.5	23.8	21.0Ω/km	27.2Ω/km								
		CEC:			(Tech Info	1000	304.8	107.0	48.6									
		CM			Section)													
	9774	NEC:	6	See Chart 3	100	30.5	16.1	7.3	6.4Ω/M'	8.3Ω/M'	.560	14.22	50	66%	30	98	55	180
		CM			500	152.4	89.5	40.9	21.0Ω/km	27.2Ω/km								
		CEC:			(Tech Info	1000	304.8	176.0	80.8									
		CM			Section)													
	9775	NEC:	9	See Chart 3	100	30.5	25.8	11.7	6.4Ω/M'	8.3Ω/M'	.655	16.64	50	66%	30	98	55	180
		CM			500	152.4	123.0	55.8	21.0Ω/km	27.2Ω/km								
CEC:		(Tech Info			1000	304.8	241.0	109.4										
CM		Section)																
9776	NEC:	12	See Chart 3	100	30.5	31.6	14.4	6.4Ω/M'	8.3Ω/M'	.735	18.67	50	66%	30	98	55	180	
	CM			500	152.4	151.5	69.0	21.0Ω/km	27.2Ω/km									
	CEC:			(Tech Info	1000	304.8	307.0	139.4										
	CM			Section)														
9777	NEC:	15	See Chart 3	100	30.5	38.8	17.6	6.4Ω/M'	8.3Ω/M'	.819	20.80	50	66%	30	98	55	180	
	CM			500	152.4	194.0	88.1	21.0Ω/km	27.2Ω/km									
	CEC:			(Tech Info	1000	304.8	421.0	191.1										
	CM			Section)														

DCR = DC Resistance • TC = Tinned Copper

*Capacitance between conductors.

**Capacitance between one conductor and other conductors connected to shield.

See Attenuation, Rise Time and Bit Rate data for this series on page 5.39.

Individually Shielded Pairs with Overall Foil/Braid Shield

Cable Characteristics

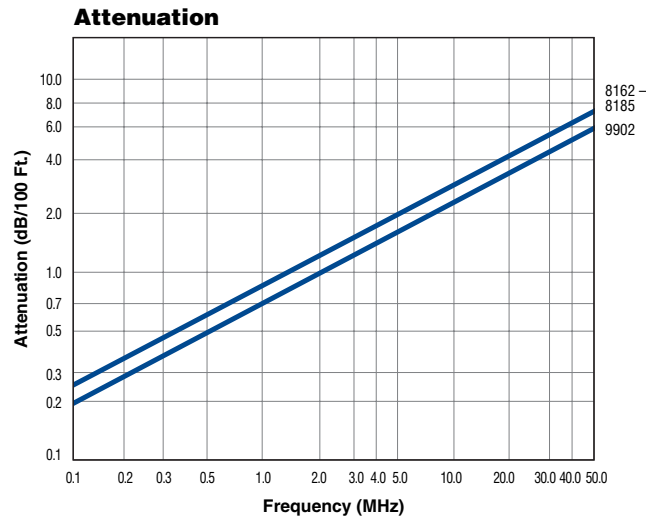

Note: see index for 9902 page number.

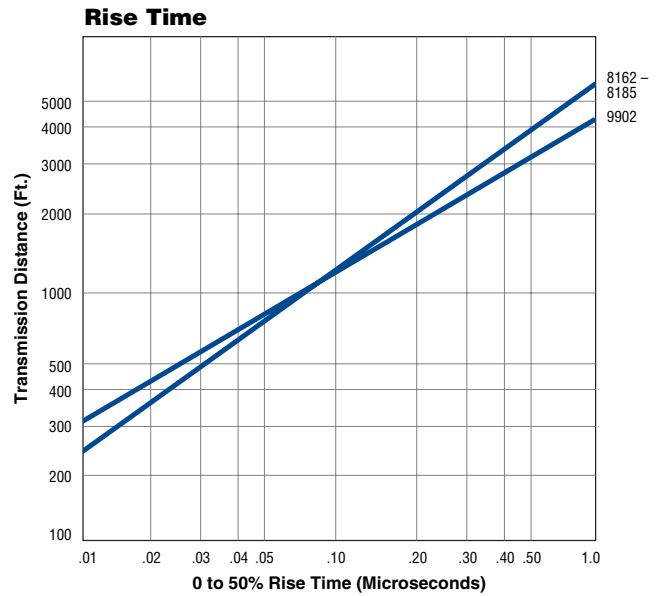

Cables are terminated in their characteristic impedance. Signal source electrical characteristics: 50 ohms and 10% to 90% rise time less than 5 nanoseconds.

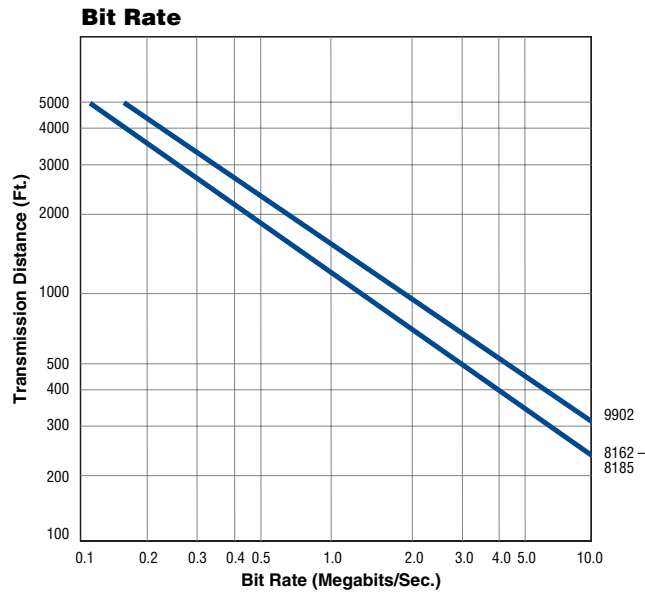

Charts assume 5% peak-to-peak time jitter as determined by eye pattern measurements of pseudorandom NRZ code.

Individually Shielded Pairs with Overall Foil/Braid Shield

Low-Capacitance Computer Cables for EIA RS-232, EIA RS-422, and Digital Audio Applications

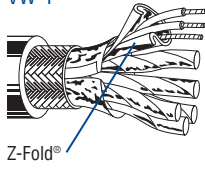
Description	Part No.	UL NEC/ C(UL) CEC Type	No. of Pairs	Color Code	Standard Lengths		Standard Unit Weight		Nom. DCR		Nominal OD		Nom. Imp. (Ω)	Nom. Vel. of Prop.	Nom. Capacitance			
					Ft.	m	Lbs.	kg	Cond.	Shield	Inch	mm			* pF/ Ft.	* pF/ m	** pF/ Ft.	** pF/ m
24 AWG Stranded (7x32) TC Conductors • Twisted Pairs Individually Beldfoil® Shielded + Overall Beldfoil (100% Coverage) + TC Braid Shield (65%) • Drain Wire[▲]																		
Datalene® Insulation • Chrome PVC Jacket																		
UL AWM Style 2493 (60°C) VW-1 	8162	NEC: CM CEC: CM	2	See Chart 3 (Tech Info Section)	100 500 1000	30.5 152.4 304.8	6.2 30.0 57.0	2.8 13.6 25.9	24.0Ω/M' 78.7Ω/km	Individual: 18.0Ω/M' 59.1Ω/km Overall: 4.3Ω/M' 14.1Ω/km	.343 8.71	100	78%	12.5	41	22	72.2	
	8163	NEC: CM CEC: CM	3	See Chart 3 (Tech Info Section)	100 500 1000	30.5 152.4 304.8	7.0 34.0 66.0	3.2 15.5 30.0	24.0Ω/M' 78.7Ω/km	Individual: 18.0Ω/M' 59.1Ω/km Overall: 4.4Ω/M' 14.4Ω/km	.359 9.12	100	78%	12.5	41	22	72.2	
	8164	NEC: CM CEC: CM	4	See Chart 3 (Tech Info Section)	100 500 1000	30.5 152.4 304.8	8.2 39.5 79.0	3.7 18.0 35.9	24.0Ω/M' 78.7Ω/km	Individual: 18.0Ω/M' 59.1Ω/km Overall: 3.2Ω/M' 10.5Ω/km	.388 9.86	100	78%	12.5	41	22	72.2	
	8165	NEC: CM CEC: CM	5	See Chart 3 (Tech Info Section)	100 500 1000	30.5 152.4 304.8	9.0 45.0 89.0	4.1 20.5 40.5	24.0Ω/M' 78.7Ω/km	Individual: 18.0Ω/M' 59.1Ω/km Overall: 3.4Ω/M' 11.2Ω/km	.413 10.49	100	78%	12.5	41	22	72.2	
	8166	NEC: CM CEC: CM	6	See Chart 3 (Tech Info Section)	100 500 1000	30.5 152.4 304.8	9.0 50.0 99.0	4.1 22.7 45.0	24.0Ω/M' 78.7Ω/km	Individual: 18.0Ω/M' 59.1Ω/km Overall: 2.8Ω/M' 9.2Ω/km	.446 11.33	100	78%	12.5	41	22	72.2	
	8167	NEC: CM CEC: CM	7	See Chart 3 (Tech Info Section)	500 1000	152.4 304.8	52.5 103.0	23.9 46.7	24.0Ω/M' 78.7Ω/km	Individual: 18.0Ω/M' 59.1Ω/km Overall: 2.8Ω/M' 9.2Ω/km	.446 11.33	100	78%	12.5	41	22	72.2	

[▲]24 AWG stranded TC drain wire

DCR = DC Resistance • TC = Tinned Copper

*Capacitance between conductors.

**Capacitance between one conductor and other conductors connected to shield.

Datalene insulation features include low dielectric constant and a dissipation factor for high-speed, low-distortion data handling. Physical properties include good crush resistance and light weight.

Individually Shielded Pairs with Overall Foil/Braid Shield

Low-Capacitance Computer Cables for EIA RS-232, EIA RS-422, and Digital Audio Applications

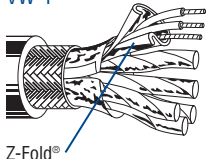
Description	Part No.	UL NEC/ C(UL) CEC Type	No. of Pairs	Color Code	Standard Lengths		Standard Unit Weight		Nom. DCR		Nominal OD		Nom. Imp. (Ω)	Nom. Vel. of Prop.	Nom. Capacitance			
					Ft.	m	Lbs.	kg	Cond.	Shield	Inch	mm			* pF/ Ft.	* pF/ m	** pF/ Ft.	** pF/ m
24 AWG Stranded (7x32) TC Conductors • Twisted Pairs Individually Beldfoil® Shielded + Overall Beldfoil (100% Coverage) + TC Braid Shield (65%) • Drain Wire [▲]																		
Datalene® Insulation • Chrome PVC Jacket																		
UL AWM Style 2493 (60°C) VW-1 	8168	NEC:	8	See	100	30.5	10.8	4.9	24.0Ω/M'	Individual:	.479 12.17	100	78%	12.5	41	22	72.2	
		CM		Chart 3	500	152.4	61.5	28.0	78.7Ω/km	18.0Ω/M'								
		CEC:		(Tech Info	1000	304.8	115.0	52.3	59.1Ω/km	Overall:								
		CM		Section)					3.0Ω/M'	9.8Ω/km								
	8170	NEC:	10	See	100	30.5	18.0	8.2	24.0Ω/M'	Individual:	.584 14.83	100	78%	12.5	41	22	72.2	
CM		Chart 3		500	152.4	83.0	37.7	78.7Ω/km	18.0Ω/M'									
CEC:		(Tech Info		1000	304.8	164.0	74.5	59.1Ω/km	Overall:									
CM		Section)						2.7Ω/M'	8.9Ω/km									
	8175	NEC:	15	See	100	30.5	22.6	10.3	24.0Ω/M'	Individual:	.665 16.89	100	78%	12.5	41	22	72.2	
CM		Chart 3		500	152.4	107.5	48.9	78.7Ω/km	18.0Ω/M'									
CEC:		(Tech Info		1000	304.8	210.0	95.5	59.1Ω/km	Overall:									
CM		Section)						2.5Ω/M'	8.2Ω/km									
	8178	NEC:	18	See	100	30.5	24.6	11.2	24.0Ω/M'	Individual:	.686 17.42	100	78%	12.5	41	22	72.2	
CM		Chart 3		500	152.4	117.0	53.2	78.7Ω/km	18.0Ω/M'									
CEC:		(Tech Info		1000	304.8	238.0	108.2	59.1Ω/km	Overall:									
CM		Section)						2.6Ω/M'	8.5Ω/km									
	8185	NEC:	25	See	100	30.5	32.3	14.7	24.0Ω/M'	Individual:	.822 20.88	100	78%	12.5	41	22	72.2	
CM		Chart 3		500	152.4	160.5	73.0	78.7Ω/km	18.0Ω/M'									
CEC:		(Tech Info		1000	304.8	356.0	161.8	59.1Ω/km	Overall:									
CM		Section)						2.4Ω/M'	7.9Ω/km									

[▲]24 AWG stranded TC drain wire

DCR = DC Resistance • TC = Tinned Copper

*Capacitance between conductors.

**Capacitance between one conductor and other conductors connected to shield.

Combination Shields

Special Audio, Communication and Instrumentation Cables

Description	Part No.	UL NEC/ C(UL) CEC Type	No. of Pairs	Color Code	Standard Lengths		Standard Unit Weight		Insulation Thickness		Jacket Thickness		Nominal OD		Nominal Capacitance			
					Ft.	m	Lbs.	kg	Inch	mm	Inch	mm	Inch	mm	* pF/ Ft.	* pF/ m	** pF/ Ft.	** pF/ m

25 AWG Stranded (7x33) Tinned Copper Conductors • Overall Beldfoil® Shield (100% Coverage) • 25 AWG Stranded TC Drain Wire

Polyethylene Insulation • Chrome PVC Jacket (Pairs Cabled on Common Axis to Reduce Diameter)

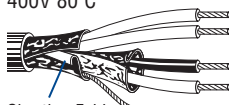
 <p>400V 80°C</p> <p>Shorting Fold</p>	8434		2	Shielded: Red & Black	100	30.5	2.1	1.0	.013	.33	.020	.51	.165	4.19	25	82	40	131				
					500	152.4	7.0	3.2														
					U-1000	U-304.8	14.0	6.4														
					1000	304.8	12.0	5.5														

Red/Black pair 100% Beldfoil shielded with drain wire.
3 copper, 4 copper-covered steel strands in each conductor.

22 AWG Stranded (7x30) Tinned Copper Conductors • One Pair Beldfoil Shielded (100% Coverage) • Stranded Tinned Copper Drain Wire

PVC Insulation • Chrome PVC Jacket (Pair and Single Cabled)

 <p>300V RMS 90°C</p>	9685	NEC: CM	1.5 (1 pair + 1 single)	Shielded: Black & White	U-1000	U-304.8	24.0	10.9	.013	.33	.032	.81	.199	5.05	60	197	99	325
					Unshielded: Brown													

Meets NEC Article 800
22 AWG drain wire

Polypropylene Insulation • Chrome PVC Jacket (Pairs Cabled on Common Axis to Reduce Diameter)

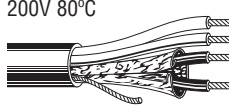
 <p>200V 80°C</p> <p>24 AWG drain wire</p>	8730[†]		2	Shielded: Red & Black	U-1000	U-304.8	24.0	10.9	.008	.20	.030	.76	.205	5.21	34	112	67	220
					1000	304.8	26.0	11.8										

 <p>300V 80°C VW-1</p> <p>24 AWG drain wire</p>	8724[†]	NEC: CM CEC: CM	2	Shielded: Red & Black	U-1000	U-304.8	21.0	9.5	.008	.20	.019	.48	.165	4.19	34	112	67	220
					1000	304.8	21.0	9.5										

22 AWG Stranded (7x30) TC Conductors • Cabled in Pairs • Overall Beldfoil Shield (100% Coverage) • 24 AWG Stranded TC Drain Wires

Polypropylene Insulation • Chrome PVC Jacket (Pairs Cabled on Common Axis to Reduce Diameter)

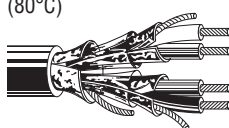
 <p>UL AWM Style 2717 (80°C)</p>	8728	NEC: CM CEC: CM	2	Black & Red	U-500	U-152.4	15.5	7.0	.010	.25	.028	.71	.215	5.46	35	115	62	203			
					500	152.4	15.5	7.0													
					U-1000	U-304.8	30.0	13.6													
					1000	304.8	31.0	14.0													

Meets NEC Article 800
Each pair Beldfoil shielded with individual drain wire plus polyester film over each shield.

TC = Tinned Copper

*Capacitance between conductors.

**Capacitance between one conductor and other conductors connected to shield.

† Request Technical Bulletin T/8-21 before planning high and low level circuits in the same cable.

Combination Shields

Special Audio, Communication and Instrumentation Cables

Description	Part No.	UL NEC/ C(UL) CEC Type	No. of Pairs	Color Code	Standard Lengths		Standard Unit Weight		Insulation Thickness		Jacket Thickness		Nominal OD		Nominal Capacitance			
					Ft.	m	Lbs.	kg	Inch	mm	Inch	mm	Inch	mm	* pF/ Ft.	* pF/ m	** pF/ Ft.	** pF/ m

20 AWG Stranded (7x28) TC Conductors • Conductors Cabled • Beldfoil® Shield as noted (100% Coverage) • 20 or 22 AWG Stranded TC Drain Wire

Polyethylene Insulation • Chrome PVC Jacket

350V 80°C	8763	—	1.5 (1 pair + 1 single)	Shielded: Black & Red Unshielded: Clear	1000	304.8	25.0	11.4	.014	.36	.028	.71	.210	5.33	26	85	48	157
-----------	-------------	---	-------------------------------	---	------	-------	------	------	------	-----	------	-----	------	------	----	----	----	-----



Beldfoil shield over Red and Black pair only. Clear conductor is unshielded. 20 AWG drain wire.

PVC Insulation • Chrome PVC Jacket (Pairs Cabled on Common Axis to Reduce Diameter)

350V 80°C	8722	NEC: CMG CEC: CMG FT4	2	Shielded: Red & Black Unshielded: Green & White	U-500	U-152.4	18.0	8.2	.015	.38	.028	.71	.226	5.74	60	197	99	325
VW-1					500	152.4	18.5	8.4										
					U-1000	U-304.8	35.0	15.9										
					1000	304.8	36.0	16.4										



Beldfoil shield over Red and Black conductors only. 22 AWG drain wire.
Request Technical Bulletin T/8-21 before planning high and low level circuits in the same cable.

Polypropylene Insulation • Chrome PVC Jacket (Cabled Around a Common Axis)

400V 105°C	8725	NEC: CM CEC: CM	4	Red & Black; Green & White; White/Red & White/Black; White/Green & White/Yellow	500	152.4	38.0	17.3	.015	.38	.030	.76	.345	8.76	27	89	49	161
VW-1					1000	304.8	74.0	33.6										

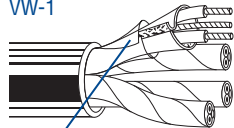

Shorting Fold
Four groups of two conductors with drain wires, each group individually Beldfoil shielded with polyester tape wrap. 22 AWG drain wire.

20 and 18 AWG Stranded (7x28 and 16x30) TC Conductors • Beldfoil Shield (100% Coverage) over 20 AWG Pair • 22 AWG Stranded TC Drain Wire

Polyethylene Insulation • Beige PVC Jacket

UL AWM Style 2094 (300V 60°C)	9155	NEC: CM CEC: CM	2	1 Shld Black & Red 1 Unshld Green & 18 (16x30) White	500	152.4	22.5	10.2	.020	.51	.031	.79	.262	6.65	24	79	46	151
					U-1000	U-304.8	46.0	20.9										
					1000	304.8	48.0	21.8										
									.019	.48					22	72		



NEC Article 800
TC = Tinned Copper
*Capacitance between conductors.
**Capacitance between one conductor and other conductors connected to shield.

Plenum-Rated

Unshielded

Audio, Control and Instrumentation Cables

Description	Part No.	UL NEC/ C(UL) CEC Type	No. of Pairs	Color Code	Standard Lengths		Standard Unit Weight		Insulation Thickness		Jacket Thickness		Nominal OD	
					Ft.	m	Lbs.	kg	Inch	mm	Inch	mm	Inch	mm

22 AWG Stranded (7x30) Tinned Copper Conductors • Twisted Pairs

Plenum • FEP Insulation • Red FEP Jacket

	88442	NEC:	1	Black & Red	100	30.5	2.3	1.0	.006	.15	.012	.30	.102	2.59
		CMP			500 [†]	152.4	5.5	2.5						
		CEC:			1000 [†]	304.8	8.0	3.6						
		CMP FT6												
	88741	NEC:	2	Black & Red, Black & White	500 [†]	152.4	8.0	3.6	.006	.15	.012	.30	.169	4.29
		CMP			1000 [†]	304.8	16.0	7.3						
		CEC:												
		CMP FT6												
	88757	NEC:	4	Black & Red, Black & White, Black & Green, Black & Blue	500 [†]	152.4	14.0	6.4	.006	.15	.012	.30	.200	5.08
		CMP			1000 [†]	304.8	28.0	12.7						
		CEC:												
		CMP FT6												

Plenum • FEP Insulation • Natural Flamarrest® Jacket

	82442	NEC:	1	Black & Red	U-1000 [†]	U-304.8	9.0	4.1	.006	.15	.014	.36	.112	2.84
		CMP			1000 [†]	304.8	8.0	3.6						
		CEC:												
		CMP FT6												
	82741	NEC:	2	Black & Red, Black & White	U-1000 [†]	U-304.8	18.0	8.2	.006	.15	.014	.36	.179	4.55
		CMP			1000 [†]	304.8	20.0	9.1						
		CEC:												
		CMP FT6												
	82742	NEC:	3	Black & Red, Black & White, Black & Green	U-1000 [†]	U-304.8	24.0	10.9	.006	.15	.014	.36	.191	4.85
		CMP			1000 [†]	304.8	26.0	11.8						
		CEC:												
		CMP FT6												
	82757	NEC:	4	Black & Red, Black & White, Black & Green, Black & Blue	1000	304.8	32.0	14.5	.006	.15	.014	.36	.210	5.33
		CMP												
		CEC:												
		CMP FT6												
	82743	NEC:	6	Black & Red, Black & White, Black & Green, Black & Blue, Black & Yellow, Black & Brown	U-1000	U-304.8	44.0	20.0	.006	.15	.015	.38	.238	6.05
		CMP			1000	304.8	46.0	20.9						
		CEC:												
		CMP FT6												

18 AWG Stranded (19x30) Tinned Copper Conductors • Twisted Pair

Plenum • FEP Insulation • Red FEP Jacket

	89740	NEC:	1	Black & Red	100	30.5	3.0	1.4	.006	.15	.009	.23	.136	3.45
		CMP			500 [†]	152.4	9.0	4.1						
		CEC:			1000 [†]	304.8	15.0	6.8						
		CMP FT6												

Plenum • FEP Insulation • Red Fluorocopolymer Jacket

	87740	NEC:	1	Black & Red	500 [†]	152.4	9.0	4.1	.006	.15	.011	.28	.140	3.56
		CMP			1000 [†]	304.8	17.0	7.7						
		CEC:												
		CMP FT6												

Plenum • FEP Insulation • Natural Flamarrest Jacket

	82740	NEC:	1	Black & Red	U-1000	U-304.8	17.0	7.7	.006	.15	.015	.38	.147	3.73
		CMP			1000	304.8	16.0	7.3						
		CEC:												
		CMP FT6												

[†]Spools and/or UnReel® cartons are one piece, but length may vary ±10% for spools and ±5% for UnReel from length shown.

Plenum-Rated

Overall Beldfoil® Shield

Computer Cables for EIA RS-232 Applications

Description	Part No.	UL NEC/ C(UL) CEC Type	No. of Pairs	Color Code	Standard Lengths		Standard Unit Weight		Insulation Thickness		Jacket Thickness		Nominal OD		Nominal Capacitance			
					Ft.	m	Lbs.	kg	Inch	mm	Inch	mm	Inch	mm	* pF/ Ft.	* pF/ m	** pF/ Ft.	** pF/ m

24 AWG Stranded (7x32) Tinned Copper Conductors • Twisted Pairs • Overall Beldfoil Shield (100% Coverage) • 24 AWG Stranded TC Drain Wire

Plenum • FEP Insulation • Red FEP Jacket

	88641	NEC:	1	Black & Red	100	30.5	2.4	1.1	.006	.15	.014	.36	.106	2.69	31	102	59	194			
		CMP:			500†	152.4	6.0	2.7													
		CEC:			1000†	304.8	9.0	4.1													
		CMP FT6																			
	89503	NEC:	3	Black & White, Black & Red, Black & Green	100	30.5	4.0	1.8	.006	.15	.014	.36	.175	4.45	21	69	40	131			
		CMP:			500†	152.4	10.5	4.8													
		CEC:			1000†	304.8	21.0	9.5													
		CMP FT6																			
	89504	NEC:	4	Black & White, Black & Red, Black & Green, Black & Blue	500†	152.4	13.0	5.9	.006	.15	.014	.36	.192	4.88	21	69	40	131			
		CMP:			1000†	304.8	29.0	13.2													
		CEC:																			
		CMP FT6																			
	89505	NEC:	5	Black & White, Black & Red, Black & Green, Black & Blue, Black & Yellow	100	30.5	4.9	2.2	.006	.15	.014	.36	.197	5.00	21	69	40	131			
		CMP:			1000†	304.8	33.0	15.0													
		CEC:																			
		CMP FT6																			

Plenum • FEP Insulation • Natural Flamarrest® Jacket

	82641	NEC:	1	Black & Red	U-1000	U-304.8	9.0	4.1	.006	.15	.014	.36	.106	2.69	31	102	59	194			
		CMP:			1000	304.8	8.0	3.6													
		CEC:																			
		CMP FT6																			
	82502	NEC:	2	Black & White, Black & Red	U-500	U-152.4	8.0	3.6	.006	.15	.014	.36	.162	4.11	25	82	45	148			
		CMP:			U-1000	U-304.8	16.0	7.3													
		CEC:			1000	304.8	14.0	6.4													
		CMP FT6																			
	82503	NEC:	3	Black & White, Black & Red, Black & Green	U-1000	U-304.8	19.0	8.6	.006	.15	.014	.36	.169	4.29	25	82	45	148			
		CMP:			1000	304.8	18.0	8.2													
		CEC:																			
		CMP FT6																			
	82504	NEC:	4	Black & White, Black & Red, Black & Green, Black & Blue	U-1000	U-304.8	24.0	10.9	.006	.15	.014	.36	.193	4.90	25	82	45	148			
		CMP:			1000	304.8	26.0	11.8													
		CEC:																			
		CMP FT6																			
	82505	NEC:	5	See Chart 3 (Tech Info Section)	U-1000	U-304.8	29.0	13.2	.006	.15	.015	.38	.196	4.98	25	82	45	148			
		CMP:			1000	304.8	31.0	14.0													
		CEC:																			
		CMP FT6																			
	82506	NEC:	6	See Chart 3 (Tech Info Section)	U-500	U-152.4	17.5	8.0	.006	.15	.015	.38	.209	5.31	25	82	45	148			
		CMP:			U-1000	U-304.8	34.0	15.5													
		CEC:			1000	304.8	35.0	15.9													
		CMP FT6																			
	82509	NEC:	9	See Chart 3 (Tech Info Section)	1000	304.8	49.0	22.3	.006	.15	.015	.38	.246	6.25	23	75	42	138			
		CMP:																			
		CEC:																			
		CMP FT6																			
	82512	NEC:	12.5 (12 pairs + 1 single)	See Chart 3 (Tech Info Section)	1000	304.8	60.0	27.3	.006	.15	.015	.38	.278	7.06	23	75	42	138			
		CMP:																			
		CEC:																			
		CMP FT6																			

TC = Tinned Copper

*Capacitance between conductors.

**Capacitance between one conductor and other conductors connected to shield.

† Spools and/or UnReel® cartons are one piece, but length may vary ±10% for spools and ±5% for UnReel from length shown.

Plenum-Rated

Overall Beldfoil® Shield

Low-Capacitance Computer Cables for EIA RS-232 and EIA RS-422 Applications

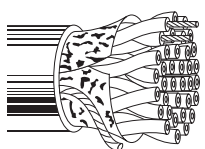
Description	Part No.	UL NEC/ C(UL) CEC Type	No. of Pairs	Color Code	Standard Lengths		Standard Unit Weight		Nom. DCR		Nominal OD		Nom. Imp. (Ω)	Nom. Vel. of Prop.	Nom. Capacitance			
					Ft.	m	Lbs.	kg	Cond.	Shield	Inch	mm			* pF/ Ft.	* pF/ m	** pF/ Ft.	** pF/ m
24 AWG Stranded (7x32) Tinned Copper Conductors • Twisted Pairs • Overall Beldfoil Shield (100% Coverage) • 24 AWG Stranded TC Drain Wire																		
Plenum • Foam FEP Insulation • Gray Fluorocopolymer Jacket																		
	300V RMS	88102	NEC: CMP CEC: CMP FT6	2	See Chart 5 (Tech Info Section)	500 1000	152.4 304.8	10.0 20.0	4.5 9.1	24.0Ω/M' 78.7Ω/km	15.5Ω/M' 50.9Ω/km	.203 5.16	100	78%	12.95	42.5	23.3	76.4
		88103	NEC: CMP CEC: CMP FT6	3	See Chart 5 (Tech Info Section)	500 1000	152.4 304.8	13.5 31.0	6.1 14.1	24.0Ω/M' 78.7Ω/km	15.5Ω/M' 50.9Ω/km	.239 6.07	100	78%	12.95	42.5	23.3	76.4
		88104	NEC: CMP CEC: CMP FT6	4	See Chart 5 (Tech Info Section)	500 1000	152.4 304.8	17.0 38.0	7.7 17.3	24.0Ω/M' 78.7Ω/km	14.0Ω/M' 45.9Ω/km	.259 6.58	100	78%	12.95	42.5	23.3	76.4
		88105	NEC: CMP CEC: CMP FT6	5	See Chart 5 (Tech Info Section)	500 1000	152.4 304.8	23.5 44.0	10.7 20.0	24.0Ω/M' 78.7Ω/km	14.0Ω/M' 45.9Ω/km	.267 6.78	100	78%	12.95	42.5	23.3	76.4
		88106	NEC: CMP CEC: CMP FT6	6	See Chart 5 (Tech Info Section)	500 1000	152.4 304.8	26.5 50.0	12.0 22.7	24.0Ω/M' 78.7Ω/km	14.0Ω/M' 45.9Ω/km	.293 7.44	100	78%	12.95	42.5	23.3	76.4
		88107	NEC: CMP CEC: CMP FT6	7.5 (7 pairs + 1 single)	See Chart 5 (Tech Info Section)	500 1000	152.4 304.8	31.0 59.0	14.1 26.8	24.0Ω/M' 78.7Ω/km	14.0Ω/M' 45.9Ω/km	.293 7.44	100	78%	12.95	42.5	23.3	76.4
		88109	NEC: CMP CEC: CMP FT6	9	See Chart 5 (Tech Info Section)	500 1000	152.4 304.8	36.5 74.0	16.6 33.6	24.0Ω/M' 78.7Ω/km	13.0Ω/M' 42.7Ω/km	.352 8.94	100	78%	12.95	42.5	23.3	76.4
		88112	NEC: CMP CEC: CMP FT6	12.5 (12 pairs + 1 single)	See Chart 5 (Tech Info Section)	500 1000	152.4 304.8	48.0 97.0	21.8 44.1	24.0Ω/M' 78.7Ω/km	11.8Ω/M' 38.7Ω/km	.397 10.08	100	78%	12.95	42.5	23.3	76.4
		88118	NEC: CMP CEC: CMP FT6	18.5 (18 pairs + 1 single)	See Chart 5 (Tech Info Section)	500 1000	152.4 304.8	71.0 148.0	32.2 67.3	24.0Ω/M' 78.7Ω/km	11.0Ω/M' 36.1Ω/km	.482 12.24	100	78%	12.95	42.5	23.3	76.4
		88125	NEC: CMP CEC: CMP FT6	25	See Chart 5 (Tech Info Section)	500† 1000†	152.4 304.8	98.0 195.0	44.5 88.6	24.0Ω/M' 78.7Ω/km	9.6Ω/M' 31.5Ω/km	.581 14.76	100	78%	12.95	42.5	23.3	76.4

DCR = DC Resistance • TC = Tinned Copper

*Capacitance between conductors.

**Capacitance between one conductor and other conductors connected to shield.

† Spools are one piece, but length may vary ±10% from length shown.

Plenum-Rated

Overall Beldfoil® Shield

Audio, Control and Instrumentation Cables

Description	Part No.	UL NEC/ C(UL) CEC Type	No. of Pairs	Color Code	Standard Lengths		Standard Unit Weight		Insulation Thickness		Jacket Thickness		Nominal OD		Nominal Capacitance			
					Ft.	m	Lbs.	kg	Inch	mm	Inch	mm	Inch	mm	* pF/ Ft.	* pF/ m	** pF/ Ft.	** pF/ m

22 AWG Stranded (7x30) Tinned Copper Conductors • Twisted Pair • Overall Beldfoil Shield (100% Coverage) • 22 AWG Stranded TC Drain Wire

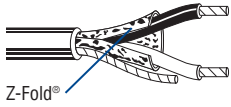
Plenum • FEP Insulation • Red FEP Jacket																				
300V RMS  Z-Fold®	88761	NEC:	1	Black,	100	30.5	2.7	1.2	.006	.15	.014	.36	.119	3.02	35	115	67	220		
		CMP:		Red	U-500	U-152.4	7.5	3.4												
		CEC:			500	152.4	7.5	3.4												
		CMP FT6			U-1000	U-304.8	15.0	6.8												
					1000	304.8	12.0	5.5												

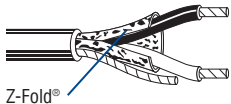
Plenum • FEP Insulation • Red Fluorocopolymer Jacket																				
300V RMS  Z-Fold®	87761	NEC:	1	Black,	500	152.4	7.0	3.2	.006	.15	.014	.36	.116	2.95	35	115	67	220		
		CMP:		Red	1000	304.8	11.0	5.0												
		CEC:																		
		CMP FT6																		

Plenum • FEP Insulation • Natural Flamarrest® Jacket																				
300V RMS  Z-Fold®	82761	NEC:	1	Black,	U-500	U-152.4	7.0	3.2	.006	.15	.014	.36	.116	2.95	35	115	67	220		
		CMP:		Red	U-1000	U-304.8	14.0	6.4												
		CEC:			1000	304.8	11.0	5.0												
		CMP FT6																		

18 AWG Stranded (19x30) Tinned Copper Conductors • Twisted Pair • Overall Beldfoil Shield (100% Coverage) • 20 AWG Stranded TC Drain Wire

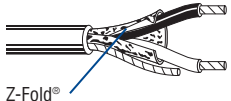
Plenum • FEP Insulation • Red FEP Jacket																				
300V RMS  Z-Fold®	88760	NEC:	1	Black,	100	30.5	3.7	1.7	.007	.18	.014	.36	.150	3.81	51	167	97	318		
		CMP:		Red	U-500	U-152.4	12.5	5.7												
		CEC:			500	152.4	11.0	5.0												
		CMP FT6			U-1000	U-304.8	24.0	10.9												
					1000	304.8	22.0	10.0												

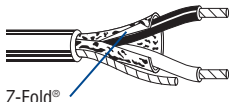
Plenum • FEP Insulation • Red Fluorocopolymer Jacket																				
300V RMS  Z-Fold®	87760	NEC:	1	Black,	U-500	U-152.4	12.5	5.7	.007	.18	.014	.36	.150	3.81	51	167	97	318		
		CMP:		Red	500	152.4	10.5	4.8												
		CEC:			1000	304.8	21.0	9.5												
		CMP FT6																		

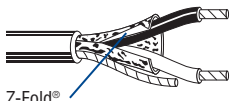
Plenum • FEP Insulation • Natural Flamarrest Jacket																				
300V RMS  Z-Fold®	82760	NEC:	1	Black,	U-500	U-152.4	12.0	5.5	.007	.18	.014	.36	.150	3.81	51	167	97	318		
		CMP:		Red	U-1000	U-304.8	22.0	10.0												
		CEC:			1000	304.8	21.0	9.5												
		CMP FT6																		

TC = Tinned Copper

*Capacitance between conductors.

**Capacitance between one conductor and other conductors connected to shield.

Plenum-Rated

Overall Foil/Braid Shield

Low-Capacitance Computer and Computer P.O.S. Cables

Description	Part No.	UL NEC/ C(UL) CEC Type	No. of Pairs	Color Code	Standard Lengths		Standard Unit Weight		Nom. DCR		Nominal OD		Nom. Imp. (Ω)	Nom. Vel. of Prop.	Nom. Capacitance			
					Ft.	m	Lbs.	kg	Cond.	Shield	Inch	mm			* pF/ Ft.	* pF/ m	** pF/ Ft.	** pF/ m

Low Cap 24 AWG Stranded (7x32) TC Conductors • Twisted Pairs • Overall Beldfoil® (100% Coverage) + TC Braid Shield (90% Cov.) • Drain Wire

Plenum • Foam FEP Insulation • Natural Flamarrest® Jacket

	300V RMS	82841	NEC: CMP CEC: CMP FT6	1	See Chart 5 (Tech Info Section)	500 1000	152.4 304.8	13.0 26.0	6.0 11.8	24.0Ω/M' 78.7Ω/km	3.1Ω/M' 10.2Ω/km	.204 5.18	120	76%	12	39.4	22	72.2
--	----------	--------------	--------------------------------	---	--	-------------	----------------	--------------	-------------	----------------------	---------------------	--------------	-----	-----	----	------	----	------

	300V RMS	82842	NEC: CMP CEC: CMP FT6	2	See Chart 5 (Tech Info Section)	500 1000	152.4 304.8	19.0 42.0	8.6 19.1	24.0Ω/M' 78.7Ω/km	2.4Ω/M' 7.9Ω/km	.273 6.93	120	76%	12	39.4	22	72.2
--	----------	--------------	--------------------------------	---	--	-------------	----------------	--------------	-------------	----------------------	--------------------	--------------	-----	-----	----	------	----	------

Plenum • Foam FEP Insulation • Red FEP Jacket

	300V RMS	89841	NEC: CMP CEC: CMP FT6	1	See Chart 5 (Tech Info Section)	500 1000	152.4 304.8	13.5 27.0	6.1 12.3	24.0Ω/M' 78.7Ω/km	3.1Ω/M' 10.2Ω/km	.202 5.13	120	76%	12	39.4	22	72.2
--	----------	--------------	--------------------------------	---	--	-------------	----------------	--------------	-------------	----------------------	---------------------	--------------	-----	-----	----	------	----	------

	300V RMS	89842 <small>new</small>	NEC: CMP CEC: CMP FT6	2	See Chart 5 (Tech Info Section)	500 1000	152.4 304.8	25.5 49.0	11.6 22.2	24.0Ω/M' 78.7Ω/km	3.1Ω/M' 10.2Ω/km	.305 7.75	120	76%	12	39.4	22	72.2
--	----------	------------------------------------	--------------------------------	---	--	-------------	----------------	--------------	--------------	----------------------	---------------------	--------------	-----	-----	----	------	----	------

22 AWG Solid TC Conductors • Twisted Pairs • Overall Beldfoil (100% Coverage) + TC Braid Shield (90% Coverage) • 22 AWG TC Drain Wire

Plenum • Solid FEP Insulation • Black FEP Jacket

	300V RMS	1269A	NEC: MPP, CMP CEC: MPP, CMP FT6	2	Red & Blue, Black & Yellow	1000	304.8	48.0	21.8	16.5Ω/M' 54.1Ω/km	2.1Ω/M' 6.9Ω/km	.240 6.10	100	69.5%	15.5	50.9	27	88.6
--	----------	--------------	---	---	-------------------------------------	------	-------	------	------	----------------------	--------------------	--------------	-----	-------	------	------	----	------

22 AWG Solid TC Conductors • Twisted Pairs • Overall Beldfoil (100% Coverage) + TC Braid Shield (55% Cov.) + Polyester Tape • 22 AWG Drain Wire

Plenum • Solid FEP Insulation • Black FEP Jacket

	300V RMS	89855	NEC: MPP, CMP CEC: MPP, CMP FT6	2	1 Pair: Red & Blue 1 Pair: Black & Yellow	500 1000	152.4 304.8	22.5 42.0	10.2 19.1	16.5Ω/M' 54.1Ω/km	4.9Ω/M' 16.1Ω/km	.272 6.91	100	69.5%	15.5	50.9	27	88.6
--	----------	--------------	---	---	---	-------------	----------------	--------------	--------------	----------------------	---------------------	--------------	-----	-------	------	------	----	------

22 AWG Solid BC Conductors • Twisted Pairs • Overall Beldfoil (100% Coverage) + TC Braid Shield (55% Coverage) • 22 AWG Solid TC Drain Wire

Plenum • Solid FEP Insulation • Black FEP Jacket

	300V RMS	89696	NEC: MPP, CMP CEC: MPP, CMP FT6	2	1 Pair: Blue & White with Blue Stripes 1 Pair: Orange & White with Orange Stripes	500 1000	152.4 304.8	25.0 46.0	11.4 20.9	16.5Ω/M' 54.1Ω/km	4.2Ω/M' 13.8Ω/km	.262 6.65	100	69.5%	15.5	50.9	27	88.6
--	----------	--------------	---	---	--	-------------	----------------	--------------	--------------	----------------------	---------------------	--------------	-----	-------	------	------	----	------

BC = Bare Copper • DCR = DC Resistance • TC = Tinned Copper

*Capacitance between conductors.

**Capacitance between one conductor and other conductors connected to shield.

Plenum-Rated

Individually Shielded Pairs

Low-Capacitance Computer Cables for EIA RS-232, EIA RS-422, and Digital Audio Applications

Description	Part No.	UL NEC/ C(UL) CEC Type	No. of Pairs	Color Code	Standard Lengths		Standard Unit Weight		Nom. DCR		Nominal OD		Nom. Imp. (Ω)	Nom. Vel. of Prop.	Nom. Capacitance			
					Ft.	m	Lbs.	kg	Cond.	Shield	Inch	mm			* pF/ Ft.	* pF/ m	** pF/ Ft.	** pF/ m

24 AWG Stranded (7x32) TC Conductors • Twisted Pairs • Individually Shielded w/Beldfoil® (100% Coverage) • 24 AWG Stranded TC Drain Wire

Plenum • Foam FEP Insulation • Gray Fluorocopolymer Jacket

	300V RMS	89729	NEC: CMP CEC: CMP FT6	2	See Chart 5 (Tech Info Section)	500 1000	152.4 304.8	17.0 31.0	7.7 14.1	23.3Ω/M' 76.4Ω/km	14.4Ω/M' 47.2Ω/km	.261 6.63	100	76%	13.5	44	22.5	73.8
		89730	NEC: CMP CEC: CMP FT6	3	See Chart 5 (Tech Info Section)	500 1000	152.4 304.8	21.5 40.0	9.8 18.2	23.3Ω/M' 76.4Ω/km	14.4Ω/M' 47.2Ω/km	.278 7.06	100	76%	13.5	44	22.5	73.8
		89728	NEC: CMP CEC: CMP FT6	4	See Chart 5 (Tech Info Section)	500 1000	152.4 304.8	26.5 50.0	12.0 22.7	23.3Ω/M' 76.4Ω/km	14.4Ω/M' 47.2Ω/km	.307 7.80	100	76%	13.5	44	22.5	73.8
		89705	NEC: CMP CEC: CMP FT6	5	See Chart 5 (Tech Info Section)	500 1000	152.4 304.8	30.5 62.0	13.9 28.2	23.3Ω/M' 76.4Ω/km	14.4Ω/M' 47.2Ω/km	.333 8.50	100	76%	13.5	44	22.5	73.8
		89731	NEC: CMP CEC: CMP FT6	6	See Chart 5 (Tech Info Section)	500 1000	152.4 304.8	35.0 71.0	15.9 32.3	23.3Ω/M' 76.4Ω/km	14.4Ω/M' 47.2Ω/km	.361 9.17	100	76%	13.5	44	22.5	73.8
		89757	NEC: CMP CEC: CMP FT6	7	See Chart 5 (Tech Info Section)	500 1000	152.4 304.8	39.5 80.0	18.0 36.4	23.3Ω/M' 76.4Ω/km	14.4Ω/M' 47.2Ω/km	.361 9.17	100	76%	13.5	44	22.5	73.8
		89732	NEC: CMP CEC: CMP FT6	9	See Chart 5 (Tech Info Section)	1000	304.8	108.0	49.2	23.3Ω/M' 76.4Ω/km	14.4Ω/M' 47.2Ω/km	.433 10.90	100	76%	13.5	44	22.5	73.8
		89734	NEC: CMP CEC: CMP FT6	12	See Chart 5 (Tech Info Section)	500 1000	152.4 304.8	71.0 140.0	32.3 63.6	23.3Ω/M' 76.4Ω/km	14.4Ω/M' 47.2Ω/km	.498 12.65	100	76%	13.5	44	22.5	73.8
		89758	NEC: CMP CEC: CMP FT6	18	See Chart 5 (Tech Info Section)	500 1000	152.4 304.8	100.5 204.0	45.7 92.7	23.3Ω/M' 76.4Ω/km	14.4Ω/M' 47.2Ω/km	.616 15.65	100	76%	13.5	44	22.5	73.8

Plenum • Foam FEP Insulation • Natural Flamarrest® Jacket

	300V RMS	82729	NEC: CMP CEC: CMP FT6	2	See Chart 5 (Tech Info Section)	U-1000 1000	U-304.8 304.8	26.0 28.0	11.8 12.7	23.3Ω/M' 76.4Ω/km	14.4Ω/M' 47.2Ω/km	.255 6.48	100	76%	13.5	44	22.5	73.8
---	----------	--------------	--------------------------------	---	--	----------------	------------------	--------------	--------------	----------------------	----------------------	--------------	-----	-----	------	----	------	------

DCR = DC Resistance • TC = Tinned Copper

*Capacitance between conductors.

**Capacitance between one conductor and other conductors connected to shield.

Plenum-Rated

Individually Shielded Pairs

Audio, Control and Instrumentation Cables

Description	Part No.	UL NEC/ C(UL) CEC Type	No. of Pairs	Color Code	Standard Lengths		Standard Unit Weight		Nom. DCR		Nominal OD		Nom. Imp. (Ω)	Nom. Vel. of Prop.	Nom. Capacitance			
					Ft.	m	Lbs.	kg	Cond.	Shield	Inch	mm			* pF/ Ft.	* pF/ m	** pF/ Ft.	** pF/ m

22 AWG Stranded (7x30) TC Conductors • Twisted Pairs • Individually Shielded Beldfoil® (100% Coverage) • 22 AWG Stranded TC Drain Wire††

Plenum • FEP Insulation • Natural Flamarrest® Jacket

 <p>300V RMS</p>	82723	NEC:	2	Red & Black,	U-500	U-152.4	10.5	4.8	14.7Ω/M'	16.6Ω/M'	.153	3.89	36	62%	43	141	75	246
		CMP			U-1000	U-304.8	20.0	9.1	48.2Ω/km	54.5Ω/km								
		CEC:			1000	304.8	19.0	8.6										
		CMP FT6			U-2000	U-609.6	40.0	18.2										

Z-Fold®

††82723 has 24 AWG drain wire
Pairs cabled on common axis to reduce diameter.

 <p>300V RMS</p>	82777	NEC:	3	See Chart 3	U-500	U-152.4	19.5	8.9	14.7Ω/M'	11.3Ω/M'	.237	6.02	46	62%	35	115	76	249
		CMP			U-1000	U-304.8	38.0	17.3	48.2Ω/km	37.1Ω/km								
		CEC:			1000	304.8	39.0	17.7										
		CMP FT6			(Tech Info Section)													

Z-Fold®

 <p>300V RMS</p>	82778	NEC:	6	See Chart 3	1000	304.8	71.0	32.2	14.7Ω/M'	11.3Ω/M'	.314	7.98	46	62%	35	115	76	249
		CMP					48.2Ω/km	37.1Ω/km										
		CEC:			(Tech Info Section)													
		CMP FT6																

Plenum • FEP Insulation • Red FEP Jacket

 <p>300V RMS</p>	88723	NEC:	2	Red & Black,	100	30.5	3.4	1.5	14.7Ω/M'	16.6Ω/M'	.148	3.76	40	69%	35	115	67	220
		CMP			500	152.4	11.0	5.0	48.2Ω/km	54.5Ω/km								
		CEC:			1000	304.8	19.0	8.6										
		CMP FT6			Green & White													

Z-Fold®

††88723 has 24 AWG drain wire

 <p>300V RMS</p>	88777	NEC:	3	See Chart 3	100	30.5	6.0	2.7	14.7Ω/M'	11.3Ω/M'	.234	5.94	50	69%	31	102	67	220
		CMP			500	152.4	19.0	8.6	48.2Ω/km	37.1Ω/km								
		CEC:			1000	304.8	42.0	19.1										
		CMP FT6			(Tech Info Section)													

Z-Fold®

 <p>300V RMS</p>	88778	NEC:	6	See Chart 3	100	30.5	7.0	3.2	14.7Ω/M'	11.3Ω/M'	.309	7.85	50	69%	31	102	67	220
		CMP			500	152.4	38.5	17.5	48.2Ω/km	37.1Ω/km								
		CEC:			1000	304.8	75.0	34.1										
		CMP FT6			(Tech Info Section)													

Pairs cabled on common axis to reduce diameter.

Plenum • FEP Insulation • Red Fluorocopolymer Jacket

 <p>300V RMS</p>	87723	NEC:	2	Red & Black,	500	152.4	11.0	5.0	14.7Ω/M'	15.0Ω/M'	.148	3.76	40	69%	35	115	67	220
		CMP			1000	304.8	18.0	8.2	48.2Ω/km	49.2Ω/km								
		CEC:			Green & White													
		CMP FT6																

Z-Fold®

††87723 has 24 AWG drain wire.

 <p>300V RMS</p>	87777	NEC:	3	See Chart 3	500	152.4	18.0	8.2	14.7Ω/M'	11.3Ω/M'	.234	5.94	50	69%	31	102	67	220
		CMP			1000	304.8	40.0	18.2	48.2Ω/km	37.1Ω/km								
		CEC:			(Tech Info Section)													
		CMP FT6																

Z-Fold®

 <p>300V RMS</p>	87778	NEC:	6	See Chart 3	500	152.4	37.5	17.0	14.7Ω/M'	11.3Ω/M'	.309	7.85	50	69%	31	102	67	220
		CMP			1000	304.8	73.0	33.2	48.2Ω/km	37.1Ω/km								
		CEC:			(Tech Info Section)													
		CMP FT6																

Pairs cabled on common axis to reduce diameter.

DCR = DC Resistance • FEP = Fluorinated Ethylene Propylene • TC = Tinned Copper

*Capacitance between conductors.

**Capacitance between one conductor and other conductors connected to shield.

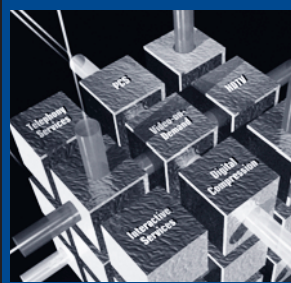

Coaxial Cables

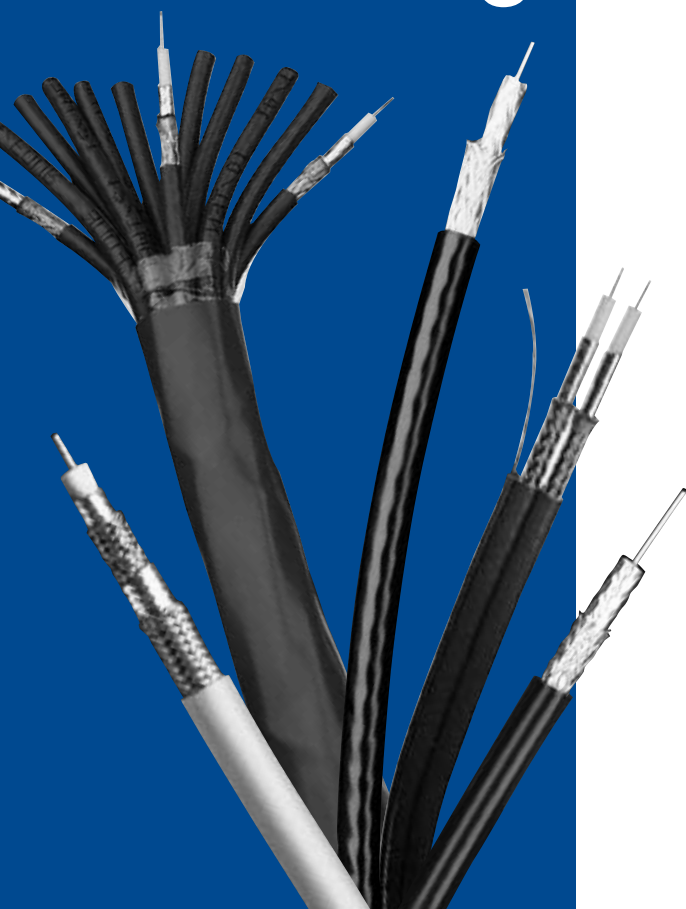

Table of Contents

Coaxial Cables	Page No.
Introduction	6.2
RG Coaxial and Triaxial Reference Guide	6.3-6.15
Broadband: MATV	6.16
Broadband: CATV	6.17-6.28
Series 59: 20 AWG	6.17
Series 6: 18 AWG	6.19
Series 11: 14 AWG	6.26
Broadband: Headend/Video Cables	6.29-6.30
DBS	6.31-6.33
Series 6: 18 AWG	6.31
Standard Analog Video	6.34-6.39
75 Ohm Miniature: 30 AWG, 27 AWG	6.34
RG-59/U Type: 23 AWG, 22 AWG, 20 AWG	6.35
RG-6/U Type: 21 AWG, 18 AWG	6.38
RG-11/U Type: 18 AWG, 14 AWG	6.39
Precision Video for Analog & Digital	6.40-6.44
Sub-Miniature RG-59/U Type: 25 AWG, 23 AWG	6.40
RG-59/U Type: 23 AWG, 22 AWG, 20 AWG	6.41
RG-6/U Type: 18 AWG	6.44
RG-11/U Type: 14 AWG	6.44
Brilliance VideoFLEX® Snake Cable	6.45-6.46
Miniature: 23 AWG	6.45
RG-59/U Type: 23 AWG, 20 AWG	6.45
RG-6/U Type: 18 AWG	6.46
Bundled RGB	6.47-6.49
High-Flex S-Video (Y/C)	6.50
Video Triax	6.51-6.54
RG-59/U Type: 22 AWG, 20 AWG	6.51
RG-11/U Type: 15 AWG, 14 AWG	6.53
DS-3 and DS-4 Interconnect & Cross-connect Cable	6.55-6.58
Low Loss 50 Ohm Wireless RF Transmission Cable	6.59-6.66
RG-174 Type: 25 AWG	6.59
RG-58 Type: 19 AWG, 17 AWG	6.60
RG-8X Type: 15 AWG	6.61
Intermediate Type: 13 AWG	6.62
RG-8 Type: 10 AWG	6.63
50 Ohm Transmission & Computer Cable	6.67-6.71
RG-174/U Type: 26 AWG	6.67
RG-188A/U Type: 26 AWG	6.67
RG-58/U Type: 20 AWG	6.67
RG-58A/U Type: 20 AWG	6.68
RG-8X Type: 16 AWG	6.69
RG-8/U Type: 13 AWG, 11 AWG, 10 AWG	6.69
Conformable® Coax	6.72-6.75
50 Ohm Microwave: 29 AWG, 24 AWG, 19 AWG, 14 AWG	6.72
75 Ohm High-Frequency Video: 29 AWG	6.74
MIL-C-17G QPL Cable	6.76-6.81
Coax: 50 Ohm, 75 Ohm, 93 Ohm, 95 Ohm, 125 Ohm	6.76
Twinax: 77 Ohm, 78 Ohm	6.81
Special Audio, Communication & Instrumentation Cable	6.82
Computer & Instrumentation Cable	6.83-6.90
Coax: 50 Ohm, 75 Ohm, 93 Ohm	6.83
Twinax: 78 Ohm, 95 Ohm, 100 Ohm, 124 Ohm, 150 Ohm	6.87
Triax: 50 Ohm	6.90
Amateur Radio & CB Coaxial Cable Assemblies	6.91
Technical Information	6.92
Table: Attenuation vs. Frequency for Broadband Coax	6.92

Introduction

Compare Belden® Coaxial cables and the companies who produce them and you will discover the obvious: Belden has no equal. That's because Belden Coaxial cables are time-tested for performance. Performance that guarantees outstanding value. Belden guarantees this level of performance because every cable is tested with equipment that simulates every known environmental and electrical performance condition. As a result, Belden Coaxial cable can be counted on for positive, reliable and trouble-free operation.

Belden Coaxial cables are engineered in a wide selection of sizes and materials, with each offering the benefits needed for physical, electrical and cost-requirement applications. Cable choices include broadband, standard analog, precision video for analog and digital, bundled RGB, high-flex S-Video, video triax, conformable coax and more.

Most of our Coax cables are available from stock. Many of these are available off the shelf from distributors. If you have a new or unusual application or you cannot find a Coax cable in this catalog section that meets your technical requirements, contact Technical Support at 1-800-BELDEN-1.

Coax Cable Shielding

Belden's line of coaxial cable features a wide range of shielding configurations. Among the options are:

Duofoil®

Duofoil is a shield in which metallic foil is applied to both sides of a supporting polyester or polypropylene film.

Duobond®

Duobond is essentially the same construction as Duofoil (a laminated shielding tape consisting of aluminum foil/plastic film/ aluminum foil), but with an extra layer of heat-sensitive adhesive bonding the foil shield to the dielectric core. This foil shield provides 100% coverage and insures maximum shield protection.

Duobond II (Foil/Braid)

Combines all the features of Duobond with an outer braid applied for greater protection against interference and to increase the overall tensile strength.

Duobond III (Tri-Shield)

Duobond III utilizes the Duobond II design (foil/braid) plus an additional surrounding layer of Duofoil. This extra layer of foil improves shield reliability and provides an additional interference barrier.

Duobond IV (Quad Shield)

Duobond IV adds a second layer of braid to the Tri-Shield design (foil/braid/foil/braid). This extra layer of braid shield provides improved strength and durability.

Duobond Plus®

Features the same foil/braid/foil construction as Duobond II but with the addition of a shorting fold in the outermost foil. This fold prevents a slot opening from being created in the shield, thereby preventing signal egress or ingress. This unique feature creates the effect of a solid metal conduit, which improves the high-frequency performance of the cable. (See the Technical Information section of this catalog for a more detailed explanation of "shorting folds.")

Coax Cable Packaging

As with most Belden cables, several Coax cable products are available in Belden's UnReel® cardboard dispenser. The UnReel is a unique packaging dispensing system developed by Belden to save time, cut costs and labor, and eliminate the need for dereeling equipment. Lightweight and more economical than conventional drums or reels, UnReel dispensers have pre-punched handles for easy, individual transport as well as rectangular boxes for easy pallet delivery and storage. UnReel cable pays out smoothly and evenly with no kinking, twisting, or backlashing. It also rolls out 60% faster than conventionally packaged cable.

Corresponding Literature

Technical Bulletins

TB-65: *Digital Studio Cable Guide*

RG Coaxial and Triaxial Reference Guide

DS-3 and DS-4 Interconnect and Cross-Connect Cables and Low Loss 50 Ohm Wireless RF Transmission Cables

Cable Designation	Part No.	Page No.	Spec. Reference	Conductor Stranding/ Dia. & Type* (DCR/1000 Ft.)	Insulation Material (OD in.)	Shield Type Tape/Braid (DCR/1000 Ft.)	Jacket Material (OD in.)	Nom. Weight (Lbs./Ft.)	Nom. Imp. (Ω)	Nom. Cap. (pF/Ft.)	Suggested Operating Temp. Range (°C) UL	Max. Oper. Voltage (RMS) Non UL
DS-3 and DS-4 Interconnect and Cross-connect Cable												
728A Type	9231	6.58	Belden	1/.031" BC (9.9)	PE (.198)	Inner None/98% SPC (187.0) Outer None/95% BC (1.1)	PVC-NC (.305)	.071	75	21.0	-40 to +60	1900
734A Type DS3-4	734A1	6.56	Belden	1/.032" BC (10.0)	GIFHDPE (.148)	BF/85% TC (2.4)	PVC (.235)	.031	75	16.8	-40 to +75	300
734A Type DS3-4 Bundled 12-Coax	734A12	6.56	Belden	1/.032" BC (10.0)	GIFHDPE (.148)	BF/85% TC (2.4)	PVC (1.026)	.484	75	16.8	-40 to +75	300
734A Type DS3-4 Plenum	734A1P	6.56	Belden	1/.032" BC (10.0)	FFEP (.148)	BF/85% TC (2.4)	FLM (.215)	.032	75	17.3	0 to +75	300
734A Type DS3-4 Bundled 6-Coax	734A6	6.56	Belden	1/.032" BC (10.0)	GIFHDPE (.148)	BF/85% TC (2.4)	PVC (.772)	.250	75	16.8	-45 to +75	300
734D Type DS3-4	734D1	6.57	Belden	1/.032" SPC (10.0)	GIFHDPE (.148)	BF/85% TC (2.4)	PVC (.235)	.031	75	16.8	-40 to +75	300
734D Type DS3-4 Bundled 12-Coax	734D12	6.57	Belden	1/.032" SPC (10.0)	GIFHDPE (.148)	BF/85% TC (2.4)	PVC (1.026)	.484	75	16.8	-40 to +75	300
734D Type DS3-4 Plenum	734D1P	6.57	Belden	1/.032" SPC (10.0)	FFEP (.148)	BF/85% TC (2.4)	FLM (.215)	.032	75	17.3	0 to +75	300
734D Type DS3-4 1-Coax with Tracer	734D1T	6.57	Belden	1/.032" SPC (10.0)	GIFHDPE (.148)	BF/85% TC (2.4)	PVC (.235 x .309)	.034	75	16.8	-40 to +75	300
734D Type DS3-4 Dual Coax	734D2	6.57	Belden	1/.032" SPC (10.0)	GIFHDPE (.148)	BF/85% TC (2.4)	PVC (.235 x .485)	.061	75	16.8	-40 to +75	300
734D Type DS3-4 2-Coax with Tracer	734D2T	6.57	Belden	1/.032" SPC (10.0)	GIFHDPE (.148)	BF/85% TC (2.4)	PVC (.235 x .574)	.068	75	16.8	-40 to +75	300
734D Type DS3-4 Bundled 6-Coax	734D6	6.57	Belden	1/.032" SPC (10.0)	GIFHDPE (.148)	BF/85% TC (2.4)	PVC (.772)	.250	75	16.8	-40 to +75	300
735A Type DS3-4	735A1	6.55	Belden	1/.0159" SPC (41.0)	FHDPE (.077)	BF/93% TC (5.3)	PVC (.129)	.011	75	17.7	-40 to +75	300
735A Type DS3-4 Bundled 12-Coax	735A12	6.55	Belden	1/.016" SPC (41.0)	FHDPE (.077)	BF/93% TC (5.3)	PVC (.581)	.171	75	17.7	-40 to +75	300
735A Type DS3-4 Bundled 16-Coax	735A16	6.55	Belden	1/.016" SPC (41.0)	FHDPE (.077)	BF/93% TC (5.3)	PVC (.636)	.226	75	17.7	-40 to +75	300
735A Type DS3-4 Plenum	735A1P	6.55	Belden	1/.016" SPC (41.0)	FFEP (.077)	BF/93% TC (5.3)	FLM (.129)	.018	75	17.7	0 to +75	300
735A Type DS3-4 1-Coax with Tracer	735A1T	6.55	Belden	1/.016" SPC (41.0)	FHDPE (.077)	BF/93% TC (5.3)	PVC (.129 x .203)	.013	75	17.7	-40 to +75	300
735A Type DS3-4 2-Coax with Tracer	73502T	6.55	Belden	1/.017" SPC (41.0)	FHDPE (.077)	BF/93% TC (5.3)	PVC (.179 x .308)	.040	75	17.7	-40 to +75	300
735A Type DS3-4 Dual Coax	735A2	6.55	Belden	1/.016" SPC (41.0)	FHDPE (.077)	BF/93% TC (5.3)	PVC (.129 x .258)	.022	75	17.7	-40 to +75	300
735A Type DS3-4 Bundled 24-Coax	735A24	6.55	Belden	1/.016" SPC (41.0)	FHDPE (.077)	BF/93% TC (5.3)	PVC (.870)	.364	75	17.7	-40 to +75	300
735A Type DS3-4 Bundled 3-Coax	735A3	6.55	Belden	1/.016" SPC (41.0)	FHDPE (.077)	BF/93% TC (5.3)	PVC (.309)	.045	75	17.7	-40 to +75	300
735A Type DS3-4 Bundled 6-Coax	735A6	6.55	Belden	1/.016" SPC (41.0)	FHDPE (.077)	BF/93% TC (5.3)	PVC (.399)	.083	75	17.7	-40 to +75	300
735A Type DS3-4 Bundled 8-Coax	735A8	6.55	Belden	1/.016" SPC (41.0)	FHDPE (.077)	BF/93% TC (5.3)	PVC (.447)	.111	75	17.7	-40 to +75	300
735A Type DS3-4 Bundled 9-Coax	735A9	6.55	Belden	1/.016" SPC (41.0)	FHDPE (.077)	BF/93% TC (5.3)	PVC (.484)	.122	75	17.7	-40 to +75	300
Low Loss 50 Ohm Wireless RF Transmission Cables												
RF300	7809A	6.62	Belden	1/.072" BC (2.1)	GIFHDPE (.190)	DB/95% TC (2.4)	PE (.300)	.046	50	23.0	-40 to +75	300
RF300 Riser	7809R	6.62	Belden	1/.072" BC (2.1)	GIFHDPE (.190)	DB/95% TC (2.4)	PVC (.300)	.046	50	23.0	-40 to +75	300
RF300 Burial	7809WB	6.62	Belden	1/.072" BC (2.1)	GIFHDPE (.190)	DB/95% TC (2.4)	PE (.300)	.046	50	23.0	-40 to +75	300
RG-174/U Type RF100A	7805	6.59	Belden	1/.018" BC (3.2)	PE (.061)	BF/90% TC (9.1)	PVC (.110)	.009	50	31.2	-40 to +75	1,100
RG-174/U Type RF100LL	7805R	6.59	Belden	1/.020" BC (27.3)	FHDPE (.060)	BF/93% TC (9.3)	PVC (.110)	.010	50	26.2	-40 to +75	300

*Inner conductors are entered as: number of strands/strand diameter (in inches).

See page 6.15 for key to abbreviations used in this table.



RG Coaxial and Triaxial Reference Guide

Low Loss 50 Ohm Wireless RF Transmission Cables
and Microwave Conformable® Coax

Cable Designation	Part No.	Page No.	Spec. Reference	Conductor Stranding/ Dia. & Type* (DCR/1000 Ft.)	Insulation Material (OD in.)	Shield Type Tape/Braid (DCR/1000 Ft.)	Jacket Material (OD in.)	Nom. Weight (Lbs./Ft.)	Nom. Imp. (Ω)	Nom. Cap. (pF/Ft.)	Suggested Operating Temp. Range (°C) UL	Max. Oper. Voltage (RMS) Non UL
Low Loss 50 Ohm Wireless RF Transmission Cables (continued)												
RG-58/U Type RF195	7806A	6.60	Belden	1/.037" BC (7.6)	GIFPE (.110)	DF/90% TC (4.2)	PE (.195)	.022	50	24.3	-40 to +75	300
RG-58/U Type RF195 Riser	7806R	6.60	Belden	1/.037" BC (7.6)	GIFPE (.110)	DF/90% TC (4.2)	PVC (.195)	.026	50	24.3	-40 to +75	300
RG-58/U Type RF200	7807A	6.60	Belden	1/.044" BC (3.3)	GIFPE (.116)	DF/95% TC (4.2)	PE (.195)	.026	50	23.5	-40 to +75	300
RG-58/U Type RF200 Riser	7807R	6.60	Belden	1/.044" BC (3.3)	GIFPE (.116)	DF/95% TC (4.2)	PVC (.195)	.029	50	23.5	-40 to +75	300
RG-8/X Type RF240	7808A	6.61	Belden	1/.057" BC (3.2)	GIFPE (.150)	DB/95% TC (3.5)	PE (.240)	.036	50	23.0	-40 to +75	300
RG-8/X Type RF240 Riser	7808R	6.61	Belden	1/.057" BC (3.2)	GIFPE (.150)	DB/95% TC (3.5)	PVC (.240)	.040	50	23.0	-40 to +75	300
RG-8/X Type RF240 Burial	7808WB	6.61	Belden	1/.057" BC (3.2)	GIFPE (.150)	DB/95% TC (3.5)	PE (.240)	.036	50	23.0	-40 to +75	300
RF300	7809A	6.62	Belden	1/.072" BC (2.0)	GIFPE (.190)	DB/95% TC (2.7)	PE (.300)	.046	50	23.0	-40 to +75	300
RF300R Riser	7809R	6.62	Belden	1/.072" BC (2.0)	GIFPE (.190)	DB/95% TC (2.7)	PVC (.300)	.053	50	23.0	-40 to +75	300
RF300WB Burial	7809WB	6.62	Belden	1/.072" BC (2.0)	GIFPE (.190)	DB/95% TC (2.7)	PE (.300)	.046	50	23.0	-40 to +75	300
RG-8/U Type RF400	7810A	6.63	Belden	1/.108" BCCA (1.3)	GIFPE (.285)	DB/95% TC (1.8)	PE (.405)	.077	50	23.0	-40 to +75	300
RG-8/U Type RF400 Riser	7810R	6.63	Belden	1/.108" BCCA (1.3)	GIFPE (.285)	DB/95% TC (1.8)	PVC (.405)	.087	50	23.0	-40 to +75	300
RG-8/U Type RF400 Burial	7810WB	6.63	Belden	1/.108" BCCA (1.3)	GIFPE (.285)	DB/95% TC (1.8)	PE (.405)	.077	50	23.0	-40 to +75	300
RF500 Aerial	7976A	6.64	Belden	1/.142" BCCA (.8)	FHDPE (.370)	DBII/90% TC (1.6)	PE (.500)	.120	50	25.1	-40 to +80	300
RF500 Aerial	7976R	6.64	Belden	1/.142" BCCA (.8)	FHDPE (.370)	DBII/90% TC (1.6)	PVC (.500)	.120	50	25.1	-40 to +80	300
RF500 Aerial	7976WB	6.64	Belden	1/.142" BCCA (.8)	FHDPE (.370)	DBII/90% TC (1.6)	PE (.500)	.120	50	25.1	-40 to +80	300
RF600 Aerial	7977A	6.65	Belden	1/.176" BCCA (.5)	FHDPE (.455)	DBII/85% TC (1.8)	PE (.590)	.163	50	24.6	-40 to +80	300
RF600 Aerial	7977R	6.65	Belden	1/.176" BCCA (.5)	FHDPE (.455)	DBII/85% TC (1.8)	PVC (.590)	.163	50	24.6	-40 to +80	300
RF600 Aerial	7977WB	6.65	Belden	1/.176" BCCA (.5)	FHDPE (.455)	DBII/85% TC (1.8)	PE (.590)	.163	50	24.6	-40 to +80	300
Microwave Conformable Coax												
RG-401/U Type Conformable	1675A	6.73	Belden	1/.065" SPCCS (2.5)	TFE (.210)	CT (8.0)	None (.246)	.081	50	29.6	-70 to +200	3,000
RG-402/U Type Conformable	1673A	6.73	Belden	1/.036" SPCCS (20.5)	TFE (.116)	CT (4.5)	None (.138)	.020	50	29.5	-70 to +200	1,900
RG-402/U Type Conformable	1673B	6.73	Belden	1/.036" SPC (7.9)	TFE (.116)	CT (4.5)	None (.138)	.020	50	29.5	-70 to +200	1,900
RG-402/U Type Conformable Jacketed	1673J	6.73	Belden	1/.036" SPCCS (20.5)	TFE (.116)	CT (4.5)	PVC (.178)	.020	50	29.5	-40 to +105	1,900
RG-405/U Type Conformable	1671A	6.72	Belden	1/.020" SPCCS (64.2)	TFE (.062)	CT (10.2)	None (.085)	.012	50	29.5	-70 to +200	1,500
RG-405/U Type Conformable	1671B	6.72	Belden	1/.020" SPC (25.7)	TFE (.062)	CT (10.2)	None (.085)	.012	50	29.5	-70 to +200	1,500
RG-405/U Type Conformable Jacketed	1671J	6.72	Belden	1/.020" SPCCS (64.2)	TFE (.062)	CT (10.2)	PVC (.127)	.016	50	29.5	-40 to +105	1,500
M17/151 Type Conformable	1674A	6.72	Belden	1/.011" SPCCS (205.0)	TFE (.034)	CT (8.0)	None (.047)	.004	50	29.5	-70 to +200	1,000
M17/151 Type Conformable	1674B	6.72	Belden	1/.011" SPCCS (81.2)	TFE (.034)	CT (8.0)	None (.047)	.004	50	29.5	-70 to +200	1,000
75 Ohm Conformable	1672A	6.74	Belden	1/.011" SCSSS (205.0)	TFE (.062)	CT (10.0)	None (.087)	.012	75	19.5	-70 to +200	1500
75 Ohm Conformable	1672B	6.74	Belden	1/.011" SPC (11.0)	TFE (.062)	CT (10.0)	None (.087)	.012	75	19.5	-70 to +200	1500
75 Ohm Conformable Jacketed	1672J	6.74	Belden	1/.011" SCSSS (205.0)	TFE (.062)	CT (10.0)	PVC (.127)	.016	75	19.5	-40 to +105	1500

*Inner conductors are entered as: number of strands/strand diameter (in inches).

See page 6.15 for key to abbreviations used in this table.



For more information, contact Belden Technical Support: 1-800-BELDEN-1 • www.belden.com

RG Coaxial and Triaxial Reference Guide

Microwave Conformable® Coax and RG-6 Type

Cable Designation	Part No.	Page No.	Spec. Reference	Conductor Stranding/ Dia. & Type* (DCR/1000 Ft.)	Insulation Material (OD in.)	Shield Type Tape/Braid (DCR/1000 Ft.)	Jacket Material (OD in.)	Nom. Weight (Lbs./Ft.)	Nom. Imp. (Ω)	Nom. Cap. (pF/Ft.)	Suggested Operating Temp. Range (°C) UL	Max. Oper. Voltage (RMS) Non UL
RG-6 Type												
RG-6/U Type Plenum	1152A	6.25	Belden, IBM P/N1501919	1/.040" BCCS (28.0)	FFEP (.170)	DF/60% TC DF/40% TC (1.8)	FEP (.273)	.048	75	16.5	-70 to +200	300
RG-6/U Type	1189A	6.24	Belden	1/.040" BCCS (28.0)	GIFPE (.180)	DBIV, 60% AL 40% AL (4.8)	PVC (.298)	.032	75	16.2	-40 to +80	300
RG-6/U Type Plenum	1189AP	6.24	Belden	1/.040" BCCS (28.0)	FFEP (.170)	DBIV/60% AL 40% AL (4.8)	FLM (.248)	.039	75	16.3	-20 to +75	300
RG-6/U Type Burial	1190A	6.25	Belden	1/.040" BCCS (28.0)	GIFPE (.180)	DBIV/60% AL 40% AL (4.8)	PE (.298)	.029	75	16.2	-55 to +80	300
RG-6/U Type Messengered	1191AM	6.24	Belden	1/.040" BCCS (28.0)	GIFPE (.180)	DBIV/60% AL 40% AL (4.8)	PVC (.298 x .433)	.040	75	16.2	-40 to +80	300
RG-6/U Type Messengered	1258AM	6.19	Belden	1/.040" BCCS (28.0)	GIFPE (.180)	DBII/60% AL (9.0)	PVC (.270 x .410)	.042	75	16.2	-40 to +80	300
RG-6/U Type Messengered	1260AM	6.23	Belden	1/.040" BCCS (28.0)	GIFPE (.180)	DB+/77% AL (5.6)	PVC (.275 x .416)	.042	75	16.2	-40 to +80	300
RG-6/U Type	1322R	6.24	Belden	1/.040" BCCS (28.0)	GIFPE (.180)	DBIV/60% AL 40% AL (4.8)	PVC (.298)	.035	75	16.2	-40 to +80	300
RG-6/U Type Composite (w/PowerPair)	1360SB	6.39	Belden	1/.040" BC (6.4)	FFEP (.180)	95% BC (3.1)	LSZH (.275 x .514)	.076	75	16.3	-30 to +75	300
RG-6/U Type	1530A	6.20	Belden	1/.040" BCCS (28.0)	GIFPE (.180)	DBII/90% AL (5.0)	PVC (.270)	.029	75	16.2	-40 to +80	300
RG-6/U Type Plenum	1530AP	6.20	Belden	1/.040" BCCS (28.0)	FFEP (.170)	DBII/90% AL (5.0)	FLM (.235)	.027	75	16.3	-20 to +75	300
RG-6/U Type Messengered	1531AM	6.20	Belden	1/.040" BCCS (28.0)	GIFPE (.180)	DBII/90% AL (5.0)	PVC (.270 x .410)	.044	75	16.2	-40 to +80	300
RG-6/U Type Burial	1532A	6.20	Belden	1/.040" BCCS (28.0)	GIFPE (.180)	DBII/90% AL (5.0)	PE (.270)	.024	75	16.2	-55 to +80	300
RG-6/U Type	1545A	6.19	Belden	1/.040" BCCS (28.0)	GIFPE (.180)	DBII/60% AL (9.0)	PVC (.270)	.030	75	16.2	-40 to +80	300
RG-6/U Type	1546A	6.21	Belden	1/.040" BCCS (28.0)	GIFPE (.180)	DBIII/60% AL (6.5)	PVC (.278)	.029	75	16.2	-40 to +80	300
RG-6/U Type	1613A	6.22	Belden	1/.040" BCCS (28.0)	GIFPE (.180)	DBIII/77% AL (5.6)	PVC (.278)	.030	75	16.2	-40 to +80	300
RG-6/U Type Burial	1614A	6.22	Belden	1/.040" BCCS (28.0)	GIFPE (.180)	DBIII/77% AL (5.6)	PE (.275)	.024	75	16.2	-55 to +80	300
RG-6/U Type Messengered	1615AM	6.22	Belden	1/.040" BCCS (28.0)	GIFPE (.180)	DBIII/77% AL (5.6)	PVC (.275 x .416)	.043	75	16.2	-40 to +80	300
RG-6/U Type Messengered	1616AM	6.22	Belden	1/.040" BCCS (28.0)	GIFPE (.180)	DBIII/77% AL (5.6)	PVC (.275 x .416)	.045	75	16.2	-40 to +80	300
RG-6/U Type Digital Video	1694A	6.44	Belden	1/.040" BC (6.4)	GIFHDPE (.180)	DF/95% TC (2.8)	PVC (.275)	.040	75	16.2	-20 to +75	300
RG-6/U Type Digital Video	1694SB	6.44	Belden	1/.040" BC (6.4)	FFEP (.170)	DF/95% TC (2.8)	FLM (.234)	.045	75	16.2	-30 to +75	300
RG-6/U Type Plenum	1695A	6.44	Belden	1/.040" BC (6.4)	FFEP (.170)	DF/95% TC (2.8)	FLM (.234)	.033	75	16.2	-40 to +80	300
RG-6/U Type	1829A	6.31	Belden	1/.040" BCCS (28.0)	GIFPE (.180)	DBII/60% AL (9.0)	PVC (.270)	.030	75	16.2	-40 to +80	300
RG-6/U Type	1829AC	6.31	Belden	1/.040" BCAC (6.4)	GIFPE (.180)	DBII/60% AL (9.0)	PVC (.270)	.030	75	16.2	-30 to +75	300
RG-6/U Type Burial	1829B	6.31	Belden	1/.040" BCCS (28.0)	GIFPE (.180)	DBII/60% AL (9.0)	PE (.270)	.024	75	16.2	-55 to +80	300
RG-6/U Type Burial	1829BC	6.31	Belden	1/.040" BCAC (6.4)	GIFPE (.180)	DBII/60% AL (9.0)	PE (.270)	.024	75	16.2	-55 to +80	300
RG-6/U Type Plenum	1829P	6.31	Belden	1/.040" BCCS (28.0)	GIFPE (.180)	DBII/60% AL (9.0)	FLM (.235)	.027	75	16.3	-20 to +75	300
RG-6/U Type	1829R	6.31	Belden	1/.040" BCCS (28.0)	GIFPE (.180)	DBII/60% AL (9.0)	PVC (.270)	.029	75	16.2	-40 to +80	300
RG-6/U Type Burial	1837A	6.21	Belden	1/.040" BCCS (28.0)	GIFPE (.180)	DBIII/60% AL (6.5)	PE (.275)	.024	75	16.2	-55 to +80	300

*Inner conductors are entered as: number of strands/strand diameter (in inches).

See page 6.15 for key to abbreviations used in this table.

RG Coaxial and Triaxial Reference Guide

RG-6 Type

Cable Designation	Part No.	Page No.	Spec. Reference	Conductor Stranding/ Dia. & Type* (DCR/1000 Ft.)	Insulation Material (OD in.)	Shield Type Tape/Braid (DCR/1000 Ft.)	Jacket Material (OD in.)	Nom. Weight (Lbs./Ft.)	Nom. Imp. (Ω)	Nom. Cap. (pF/Ft.)	Suggested Operating Temp. Range (°C) UL	Max. Oper. Voltage (RMS) Non UL
RG-6 Type (continued)												
RG-6/U Type Static Ground	1839A	6.32	Belden	1/.040" BCCS (28.0)	GIFPE (.180)	DBII/60% AL (9.0)	PVC (.270 x .405)	.040	75	16.2	-40 to +80	300
RG-6/U Type Static Ground	1839AC	6.32	Belden	1/.040" BCAC (6.4)	GIFPE (.180)	DBII/60% AL (9.0)	PVC (.270 x .405)	.040	75	16.2	-40 to +80	300
RG-6/U Type Static Ground	1840A	6.32	Belden	2/.040" BCAC (28.0)	GIFPE (.180)	DBII/60% AL (9.0)	PVC (.273 x .703)	.069	75	16.2	-40 to +80	300
RG-6/U Type Static Ground	1840AC	6.32	Belden	2/.040" BC (6.4)	GIFPE (.180)	DBII/60% AL (9.0)	PVC (.273 x .703)	.069	75	16.2	-40 to +80	300
RG-6/U Type	1841A	6.32	Belden	2/.040" BCCS (28.0)	GIFPE (.180)	DBII/60% AL (9.0)	PVC (.273 x .595)	.058	75	16.2	-40 to +80	300
RG-6/U Type	1841AC	6.32	Belden	2/.040" BCAC (6.4)	GIFPE (.180)	DBII/60% AL (9.0)	PVC (.273 x .595)	.058	75	16.2	-40 to +80	300
RG-6/U Type Burial	1843A	6.33	Belden	1/.040" BCCS (28.0)	GIFPE (.180)	DBII/60% AL (9.0)	PE (.273 x .750)	.052	75	16.2	-55 to +80	300
RG-6/U Type	3131A	6.84	Belden	1/.040" BCCS (28.0)	FPE (.180)	DBIV/67% AL 46% AL (3.6)	PVC (.300)	.033	75	16.2	-30 to +75	3000
RG-6/U Type	3132A	6.84	Belden	1/.040" BCCS (28.0)	FFPE (.170)	DBIV/67% AL 46% AL (7.2)	PVDF (.274)	.043	75	16.3	-20 to +150	300
RG-6/U Type	5339G5	6.21	Belden	1/.040" BCCS (28.0)	GIFPE (.180)	BB/50% AL (15.0)	PVC (.253)	.024	75	16.2	-40 to +80	300
RG-6/U Type	7915A	6.33	Belden	1/.040" BC (6.4)	GIFPE (.180)	DB+/77% AL (4.6)	PVC (.275)	.029	75	16.2	-40 to +80	300
RG-6/U Type	7916A	6.33	Belden	1/.040" BC (6.4)	GIFPE (.180)	DBIV/60% AL 40% AL (4.8)	PVC (.298)	.032	75	16.2	-40 to +80	300
RG-6/U Type	8215	6.38	Belden	1/.028" BCCS (32.0)	PE (.185)	None/96% BC None/95% BC (1.1)	PE (.332)	.069	75	20.5	-55 to +80	2,700
RG-6/U Type	8238	6.39	JAN-C-17A	7/.048" TC (6.1)	FRSFPE (.285)	None/97% BC (1.2)	PVC (.405)	.117	75	20.5	-40 to +80	300
RG-6/U Type	8261	6.39	MIL-C-17D	7/.048" TC (6.1)	PE (.285)	None/97% BC (1.2)	PVC (.405)	.104	75	20.5	-40 to +60	3,700
RG-6/U Type	9058	6.23	Belden	1/.040" BCCS (28.0)	GIFPE (.180)	DB+/77% AL (5.6)	PVC (.275)	.029	75	16.2	-40 to +80	300
RG-6/U Type Messengered	9058M	6.23	Belden	1/.040" BCCS (28.0)	GIFPE (.180)	DB+/77% AL (5.6)	PVC (.275 x .416)	.043	75	16.2	-40 to +80	350
RG-6/U Type Burial	9062	6.23	Belden	1/.040" BCCS (28.0)	GIFPE (.180)	DB+/77% AL (5.6)	PVC (.275)	.023	75	16.2	-55 to +80	300
RG-6/U Type Burial	9066	6.19	Belden	1/.040" BCCS (28.0)	GIFPE (.180)	DBII/60% AL (9.0)	PE (.270)	.026	75	16.2	-55 to +80	300
RG-6/U Type	9077	6.19	Belden	2/.040" BCCS (28.0)	GIFPE (.180)	DBII/60% AL (9.0)	PVC (.270 x .590)	.057	75	16.2	-40 to +80	300
RG-6/U Type	9116	6.19	Belden	1/.040" BCCS (28.0)	GIFPE (.180)	DBII/60% AL (9.0)	PVC (.270)	.030	75	16.2	-40 to +80	300
RG-6/U Type Plenum	9116P	6.19	Belden	1/.040" BCCS (28.0)	FFPE (.170)	DBII/60% AL (9.0)	FLM (.235)	.025	75	16.3	-20 to +75	300
RG-6/U Type Riser	9116R	6.19	Belden	1/.040" BCCS (28.0)	GIFPE (.180)	DBII/60% AL (9.0)	PVC (.270)	.030	75	16.2	-40 to +80	300
RG-6/U Type	9116SB	6.19	Belden	1/.040" BCCS (28.0)	GIFPE (.180)	DBII/60% AL (9.0)	LSZH (.274)	.031	75	16.2	-30 to +75	300
RG-6/U Type Messengered	9117M	6.19	Belden	1/.040" BCCS (28.0)	GIFPE (.180)	DBII/60% AL (9.0)	PVC (.270 x .410)	.042	75	16.2	-40 to +80	300
RG-6/U Type	9118	6.21	Belden	1/.040" BCCS (28.0)	GIFPE (.180)	DBIII/60% AL (6.8)	PVC (.275)	.026	75	16.2	-40 to +80	300
RG-6/U Type Messengered	9119M	6.21	Belden	1/.040" BCCS (28.0)	GIFPE (.180)	DBIII/60% AL (6.5)	PVC (.275 x .416)	.042	75	16.2	-40 to +80	300
RG-6/U Type	9248	6.38	Belden	1/.040" BC (6.4)	GIFHDPE (.180)	DF/65% TC (5.6)	PVC (.270)	.030	75	16.2	-40 to +80	300
RG-6/U Type	9290	6.38	Belden	1/.037" BC (7.5)	FPE (.180)	None/95% BC None/95% BC (2.0)	PVC (.288)	.054	75	17.3	-40 to +80	300

*Inner conductors are entered as: number of strands/strand diameter (in inches).

See page 6.15 for key to abbreviations used in this table.



RG Coaxial and Triaxial Reference Guide

RG-6, RG-8 and RG-11 Types

Cable Designation	Part No.	Page No.	Spec. Reference	Conductor Stranding/ Dia. & Type* (DCR/1000 Ft.)	Insulation Material (OD in.)	Shield Type Tape/Braid (DCR/1000 Ft.)	Jacket Material (OD in.)	Nom. Weight (Lbs./Ft.)	Nom. Imp. (Ω)	Nom. Cap. (pF/Ft.)	Suggested Operating Temp. Range (°C) UL	Max. Oper. Voltage (RMS) Non UL
RG-6 Type (continued)												
RG-6/U Type Plenum	82120	6.25	Belden	1/.040" BCCS (28.0)	FFEP (.170)	DF/95% TC (1.7)	FLM (.234)	.044	75	16.5	-20 to +75	300
RG-6/U Type Plenum	82248	6.38	Belden	1/.040" BC (6.4)	FFEP (.170)	DF/65% TC (5.1)	FLM (.222)	.035	75	16.5	-20 to +75	300
RG-6/U Type Plenum	87120	6.25	Belden	1/.040" BCCS (28.0)	FFEP (.170)	DF/95% TC (1.7)	PVDF (.234)	.043	75	16.5	-20 to +150	300
RG-6/U Type Plenum	89120	6.25	Belden	1/.040" BCCS (28.0)	FFEP (.170)	DF/95% TC (1.7)	FEP (.234)	.044	75	16.5	-70 to +200	300
RG-6/U Type Plenum	89248	6.38	Belden	1/.040" BC (6.4)	FFEP (.170)	DF/65% TC (5.1)	FEP (.222)	.035	75	16.5	-70 to +200	300
RG-8 Type												
RG-8/U Type	7733A	6.70	Belden	1/1.108" BC (0.9)	FFEP (.280)	DF/90% TC (1.8)	PVDF (.355)	.115	50	24.2	-20 to +150	300
RG-8/X Type RF240	7808A	6.61	Belden	1/1.057" BC (3.2)	GIFHDPE (.150)	DB/95% TC (2.8)	PE (.240)	.036	50	23.0	-40 to +75	300
RG-8/X Type RF240 Riser	7808R	6.61	Belden	1/1.057" BC (3.2)	GIFHDPE (.150)	DB/95% TC (2.8)	PVC (.240)	.040	50	23.0	-40 to +75	300
RG-8/X Type RF240 Burial	7808WB	6.61	Belden	1/1.057" BC (3.2)	GIFHDPE (.150)	DB/95% TC (2.8)	PE (.240)	.036	50	23.0	-40 to +75	300
RG-8/U Type RF400	7810A	6.63	Belden	1/1.108" BCCA (1.34)	GIFHDPE (.285)	DB/95% TC (2.0)	PE (.403)	.077	50	23.0	-40 to +75	300
RG-8/U Type RF400 Riser	7810R	6.63	Belden	1/1.108" BCCA (1.34)	GIFHDPE (.285)	DB/95% TC (2.0)	PVC (.403)	.087	50	23.0	-40 to +75	300
RG-8/U Type RF400 Burial	7810WB	6.63	Belden	1/1.108" BCCA (1.34)	GIFHDPE (.285)	DB/95% TC (2.0)	PE (.403)	.077	50	23.0	-40 to +75	300
RG-8/U Type	8214	6.69	Belden	7/1.108" BC (1.2)	FPE (.285)	None/97% BC (1.1)	PVC (.403)	.106	50	26.0	-40 to +80	300
RG-8/U Type	8237	6.69	JAN-C-17A	7/1.085" BC (1.9)	PE (.285)	None/97% BC (1.2)	PVC (.405)	.104	52	28.5	-40 to +75	3,700
RG-8/U Type	9251	6.69	MIL-C-17D	7/1.085" BC (1.9)	PE (.285)	None/97% BC (1.2)	PVC-NC (.405)	.099	52	28.5	-40 to +80	3,700
RG-8/X Type	9258	6.69	Belden	19/.058" BC (4.3)	GIFPE (.155)	None/95% BC (3.3)	PVC (.242)	.035	50	24.8	-30 to +80	300
RG-8/U Type Thick Ethernet	9880	6.83	Belden, DEC PN17-00451-00	1/.086" BC (1.4)	FPE (.243)	DBIV/94% TC 90% TC (1.5)	PVC (.405)	.113	50	26.0	-30 to +60	300
RG-8/U Type Triaxial	9888	6.90	Belden	7/1.108" BC (1.2)	FPE (.285)	Inner None/96% BC (1.2) Outer None/96% BC (2.1)	Inner PE (.370) Outer PE (.480)	.130	50	26.0	-55 to +80	300
RG-8/U Type	9913	6.70	Belden	1/1.108" BC (0.9)	SSPE (.286)	DBII/90% TC (1.8)	PVC (.405)	.097	50	24.6	-40 to +80	300
RG-8/U Type	9913F7	6.70	Belden	7/1.108" BC (1.1)	GIFHDPE (.285)	DB/95% TC (1.8)	BELFX (.405)	.094	52	22.5	-40 to +80	300
RG-8/U Type	9914	6.70	Belden	1/1.103" BC (1.8)	GIFHDPE (.285)	DBII/95% TC (1.1)	PVC (.403)	.108	50	24.8	-40 to +80	300
RG-8/U Type Thick Ethernet Plenum	89880	6.83	Belden, DEC PN17-00324-00	1/.086" BC (1.4)	FFEP (.245)	DBIV/90% TC 90% TC (1.5)	PVDF (.375)	.137	50	26.0	-25 to +150	300
RG-8/U Type Plenum	89913	6.70	Belden	1/1.108" BC (0.9)	SSFEP (.295)	DBII/90% TC (1.8)	PVDF (.364)	.115	50	25.0	-20 to +150	300
RG-11 Type												
RG-11/U Type Plenum	1153A	6.28	Belden, IBM P/N1501908	1/.064" BCCS (11.0)	FFEP (.280)	DF/60% TC DF/40% TC (1.8)	FEP (.387)	.092	75	16.2	-70 to +200	300
RG-11/U Type	1523A	6.26	Belden	1/.064" BCCS (11.0)	GIFPE (.280)	DBII/60% AL (4.1)	PVC (.400)	.054	75	16.2	-40 to +80	300
RG-11/U Type	1523AN	6.26	Belden	1/.064" BCCS (11.0)	GIFPE (.280)	DBII/60% AL (4.1)	PVC (.400)	.054	75	16.2	-40 to +80	300
RG-11/U Type Plenum	1523AP	6.26	Belden	1/.064" BCCS (11.0)	FFEP (.274)	DBII/60% AL (4.1)	PVDF (.348)	.057	75	16.3	-20 to +150	300

*Inner conductors are entered as: number of strands/strand diameter (in inches).

See page 6.15 for key to abbreviations used in this table.



RG Coaxial and Triaxial Reference Guide

RG/11U Type

Cable Designation	Part No.	Page No.	Spec. Reference	Conductor Stranding/ Dia. & Type* (DCR/1000 Ft.)	Insulation Material (OD in.)	Shield Type Tape/Braid (DCR/1000 Ft.)	Jacket Material (OD in.)	Nom. Weight (Lbs./Ft.)	Nom. Imp. (Ω)	Nom. Cap. (pF/Ft.)	Suggested Operating Temp. Range (°C) UL	Max. Oper. Voltage (RMS) Non UL
RG-11/U Type (continued)												
RG-11/U Type Riser	1523R	6.26	Belden	1/.064" BCCS (11.0)	GIFPE (.280)	DBII/60% AL (4.1)	PVC (.400)	.054	75	16.2	-30 to +80	300
RG-11/U Type Messengered	1524AM	6.26	Belden	1/.064" BCCS (11.0)	GIFPE (.280)	DBII/60% AL (4.1)	PVC (.400 x .580)	.070	75	16.2	-40 to +80	300
RG-11/U Type Burial	1525A	6.26	Belden	1/.064" BCCS (11.0)	GIFPE (.280)	DBII/60% AL (4.1)	PE (.400)	.046	75	16.2	-50 to +80	300
RG-11/U Type	1617A	6.28	Belden	1/.064" BCCS (11.0)	GIFPE (.280)	DBIV/60% AL 40% AL (3.0)	PVC (.407)	.059	75	16.2	-40 to +80	300
RG-11/U Type	1618A	6.28	Belden	1/.064" BCCS (11.0)	GIFPE (.280)	DBIV/60% AL 40% AL (3.0)	PE (.407)	.053	75	16.2	-55 to +80	300
RG-11/U Type Messengered	1619AM	6.28	Belden	1/.064" BCCS (11.0)	GIFPE (.280)	DBIV/60% AL 40% AL (3.0)	PVC (.407 x .560)	.075	75	16.2	-40 to +80	300
RG-11/U Type Messengered	1620AM	6.28	Belden	1/.064" CCS (11.0)	GIFPE (.280)	DBIV/60% AL 40% AL (3.0)	PVC (.407 x .560)	.078	75	16.2	-40 to +80	300
RG-11/U Type Triaxial High-Flex Version	1858A	6.53	Belden	19/.064" BC (3.1)	GIFHDPE (.312)	Inner None/95% BC (1.8) Outer None/95% BC (1.4)	Inner PE (.405) Outer BELFX (.520)	.147	75	17.3	-35 to +75	300
RG-11/U Type Triaxial Plenum	1859A	6.53	Belden	19/.064" BC (3.1)	FFEP (.285)	Inner None/95% (1.4) Outer None/87% (1.4)	Inner PVDF (.350) Outer PVDF (.406)	.120	75	16.5	-20 to +125	300
RG-11/U Type	3094A	6.84	Belden	1/.064" BCCS (11.0)	GIFPE (.280)	DBIV/67% AL 46% AL (1.5)	PVC (.407)	.059	75	16.2	-40 to +80	300
RG-11/U Type	3095A	6.85	Belden	1/.064" BCCS (11.0)	FFEP (.280)	DBIV/67% AL 46% AL (3.9)	PVDF (.387)	.068	75	16.5	-20 to +150	300
RG-11/U Type	7731A	6.44	Belden	1/.064" BC (2.5)	GIFHDPE (.280)	DF/95% TC (1.5)	PVC (.400)	.100	75	16.0	-30 to +75	300
RG-11/U Type Plenum	7732A	6.44	Belden	1/.064" BC (2.5)	FFEP (.274)	DF/95% TC (1.6)	PVDF (.348)	.075	75	16.3	-20 to +150	300
RG-11/U Type Triax Flooded	7803A	6.54	Belden	1/.064" BC (2.5)	GIFHDPE (.285)	Inner None/95% BC (1.6) Outer None/95% BC (1.4)	Inner PE (.365) Outer PE (.475)	.112	75	16.1	-55 to +80	300
RG-11/U Type Aerial	7983A	6.27	Belden	1/.064" BCCS (11.0)	GIFPE (.280)	DBIII+/77% AL (4.0)	PVC (.400 x .580)	.084	75	16.2	-40 to +80	300
RG-11/U Type Burial	7984A	6.27	Belden	1/.064" BCCS (11.0)	GIFPE (.280)	DBIII+/77% AL (4.0)	PE (.400)	.052	75	16.2	-55 to +80	300
RG-11/U Type	8213	6.39	Belden	1/.064" BC (2.6)	GIFHDPE (.285)	None/97% BC (1.1)	PE (.405)	.087	75	16.1	-55 to +80	300
RG-11/U Type Triaxial	8233	6.54	Belden	1/.064" BC (2.5)	GIFHDPE (.285)	Inner None/95% BC (1.6) Outer None/80% BC (1.4)	Inner PE (.365) Outer PE (.475)	.112	75	16.1	-55 to +80	300
RG-11/U Type Triaxial	8233A	6.54	Belden	1/.064" BC (2.5)	GIFHDPE (.285)	Inner None/95% BC (1.6) Outer None/80% BC (1.4)	Inner PVC (.365) Outer PVC (.475)	.132	75	16.1	-30 to +75	300

*Inner conductors are entered as: number of strands/strand diameter (in inches).

See page 6.15 for key to abbreviations used in this table.



RG Coaxial and Triaxial Reference Guide

RG/11U and RG-58 Types

Cable Designation	Part No.	Page No.	Spec. Reference	Conductor Stranding/ Dia. & Type* (DCR/1000 Ft.)	Insulation Material (OD in.)	Shield Type Tape/Braid (DCR/1000 Ft.)	Jacket Material (OD in.)	Nom. Weight (Lbs./Ft.)	Nom. Imp. (Ω)	Nom. Cap. (pF/Ft.)	Suggested Operating Temp. Range (°C) UL	Max. Oper. Voltage (RMS) Non UL
RG-11/U Type (continued)												
RG-11/U Type	9011	6.26	Belden	1/.064" BCCS (11.0)	GIFPE (.280)	DF/40% AL (5.3)	PVC (.400)	.060	75	16.2	-40 to +80	300
RG-11/U Type	9064	6.27	Belden	1/.064" BCCS (11.0)	GIFPE (.280)	DB+/77% AL (3.8)	PVC (.400)	.062	75	16.2	-40 to +80	300
RG-11/U Type Messengered	9065M	6.27	Belden	1/.064" BCCS (11.0)	GIFPE (.280)	DB+/77% AL (3.8)	PVC (.400 x .580)	.080	75	16.2	-40 to +80	300
RG-11/U Type Triaxial	9192	6.53	Belden	19/.064" BC (3.3)	GIFHDPE (.312)	Inner None/90% BC (1.6) Outer None/82% BC (1.6)	Inner PE (.390) Outer PVC (.520)	.134	75	17.3	-40 to +75	300
RG-11/QPL M17/6-RG11	9212	6.79	MIL-C-17G	7/.048" TC (6.1)	PE (.285)	None/97% BC (1.2)	PVC-NC (.405)	.090	75	20.5	-40 to +85	3,700
RG-11/U Type Triaxial	9232	6.53	Belden	19/.064" BC (3.0)	GIFHDPE (.312)	Inner None/90% BC (1.6) Outer None/82% BC (1.7)	Inner PE (.390) Outer H (.520)	.140	75	17.3	-20 to +75	300
RG-11/U Type	9292	6.39	Belden	1/.064" BC (2.5)	GIFHDPE (.280)	DF/61% TC (3.0)	PVC (.405)	.081	75	16.1	-40 to +80	300
RG-11/U Type Burial	9764	6.27	Belden	1/.064" BCCS (11.0)	GIFPE (.280)	DB+/77% AL (3.8)	PE (.400)	.056	75	16.2	-55 to +80	300
RG-11/U Type Plenum	89292	6.39	Belden	1/.064" BC (2.5)	FFEP (.274)	DF/63% TC (3.0)	FEP (.346)	.077	75	16.1	-70 to +200	300
RG-58 Type												
RG-58/U Type RF195	7806A	6.60	Belden	1/.037" BC (7.6)	GIFHDPE (.110)	DF/90% TC (4.2)	PE (.195)	.022	50	24.3	-40 to +75	300
RG-58/U Type RF195 Riser	7806R	6.60	Belden	1/.037" BC (7.6)	GIFHDPE (.110)	DF/90% TC (4.2)	PVC (.195)	.026	50	24.3	-40 to +75	300
RG-58/U Type RF200	7807A	6.60	Belden	1/.044" BC (3.3)	GIFHDPE (.116)	DF/95% TC (4.2)	PE (.195)	.026	50	23.5	-40 to +75	300
RG-58/U Type RF200 Riser	7807R	6.60	Belden	1/.044" BC (3.3)	GIFHDPE (.116)	DF/95% TC (4.2)	PVC (.195)	.029	50	23.5	-40 to +75	300
RG-58A/U Type	8219	6.68	Belden	19/.037" TC (8.8)	FPE (.114)	None/96% TC (4.1)	PVC (.194)	.025	53.5	26.5	-40 to +80	300
RG-58A/U	8240	6.68	JAN-C-17A	1/.033" BC (10.0)	PE (.116)	None/95% TC (4.1)	PVC (.193)	.025	51.5	28.5	-40 to +75	1,400
RG-58A/U Type	8259	6.68	JAN-C-17A	19/.035" TC (10.8)	PE (.116)	None/95% TC (4.1)	PVC (.192)	.024	50	30.8	-40 to +75	1,400
RG-58C/U QPL M17/155-00001	8262	6.77	MIL-C-17G	19/.035" TC (10.8)	PE (.115)	None/95% TC (4.1)	PVC-NC (.195)	.024	50	30.8	-40 to +85	1,400
RG-58/U Type	9201	6.67	Belden	1/.033" BC (10.0)	PE (.116)	None/78% BC (5.5)	PVC (.193)	.022	51.5	28.5	-40 to +80	1,400
RG-58/QPL M17/28-RG-58	9203	6.77	MIL-C-17G	19/.035" TC (10.8)	PE (.116)	None/95% TC (4.1)	PVC-NC (.195)	.025	50	30.8	-40 to +85	1,400
RG-58A/U Type Triaxial	9222	6.90	Belden	7/.037" TC (9.5)	PE (.114)	Inner None/96% TC (4.7) Outer None/85% TC (4.3)	Inner PE (.175) Outer PVC (.240)	.037	50	30.8	-40 to +75	1,400
RG-58/U Type	9223	6.82	Belden	7/.030" TC (10.8)	PE (.112)	DBII/95% TC (4.1)	PVC (.195)	.024	50	37.0	-40 to +80	1,900
RG-58/U Type	9310	6.67	Belden	1/.033" BC (9.4)	PE (.114)	DBII/55% TC (8.0)	PVC (.193)	.020	50	30.8	-40 to +60	1,400
RG-58A/U Type	9311	6.68	Belden	19/.037" TC (8.8)	FPE (.114)	DBII/55% TC (17.0)	PVC (.193)	.018	52	26.0	-40 to +80	300
RG-58A/U Type Thin Ethernets	9907	6.83	DEC P/N 17-01248-00	19/.037" TC (8.8)	FPE (.102)	DBII/93% TC (5.8)	PVC (.185)	.022	50	25.4	-40 to +80	300

*Inner conductors are entered as: number of strands/strand diameter (in inches).

See page 6.15 for key to abbreviations used in this table.



RG Coaxial and Triaxial Reference Guide

RG-58 and RG-59/U Types

Cable Designation	Part No.	Page No.	Spec. Reference	Conductor Stranding/ Dia. & Type* (DCR/1000 Ft.)	Insulation Material (OD in.)	Shield Type Tape/Braid (DCR/1000 Ft.)	Jacket Material (OD in.)	Nom. Weight (Lbs./Ft.)	Nom. Imp. (Ω)	Nom. Cap. (pF/Ft.)	Suggested Operating Temp. Range (°C) UL	Max. Oper. Voltage (RMS) Non UL
RG-58 Type (continued)												
RG-58A/U Type Plenum	82240	6.68	Belden	1/.032" BC (10.2)	FEP (.107)	None/95% TC (6.7)	FLM (.159)	.030	53.5	26.4	0 to +75	1,400
RG-58A/U Type Thin Ethernets Plenum	82907	6.83	Belden	19/.0375" TC (8.8)	FFEP (.095)	DBII/93% TC (5.8)	FLM (.160)	.023	50	25.4	0 to +75	300
RG-58A/U Type Plenum	88240	6.68	Belden	1/.032" BC (10.2)	FEP (.107)	None/95% TC (6.7)	FEP (.159)	.021	53.5	26.4	-70 to +200	300
RG-58A/U Type Thin Ethernet Plenum	89907	6.83	DEC P/N 17-01246-00	19/.0375" TC (8.8)	FFEP (.095)	DBII/93% TC (5.8)	PVDF (.160)	.025	50	25.4	-20 to +150	300
RG-59/U Type												
RG-59/U Type Plenum	1151A	6.18	Belden, IBM P/N 1501917	1/.032" BCCS (26.0)	FFEP (.140)	DF/52% TC DF/34% TC (2.3)	FEP (.236)	.035	75	16.5	-70 to +200	300
RG-59/U Type	1186A	6.17	Belden	1/.032" CCS (44.5)	GIFHDPE (.144)	DBIV/67% AL 40% AL (7.0)	PVC (.265)	.025	75	16.2	-40 to +80	300
RG-59/U Type	1426A	6.37	Belden	1/.032" BC (10.0)	GIFHDPE (.145)	None/95% BC (2.6)	PVC (.242)	.033	75	16.3	-30 to +75	300
RG-59/U Type	1505A	6.29	Belden	1/.032" BC (10.0)	GIFHDPE (.145)	DF/95% TC (3.8)	PVC (.234)	.031	75	16.3	-30 to +75	300
RG-59/U Type	1505F	6.29	Belden	7/.031" BC (12.2)	GIFHDPE (.145)	None/94% BC (2.4) None/94% BC (2.4)	PVC (.242)	.040	75	17.0	-35 to +75	300
RG-59/U Type Plenum	1506A	6.42	Belden	1/.032" BC (10.0)	FFEP (.133)	DF/95% TC (3.8)	FLM (.196)	.027	75	16.0	-20 to +75	300
RG-59/U Type Triaxial	1856A	6.52	Belden	1/.032" BC (10.1)	GIFHDPE (.145)	Inner None/95% BC (2.5) Outer None/95% BC (1.6)	Inner PE (.216) Outer BELFX (.360)	.070	75	16.2	-35 to +75	300
RG-59/U Type Triax	1856B	6.52	Belden	1/.032" BC (10.1)	GIFHDPE (.145)	Inner None/95% BC (2.5) Outer None/95% BC (1.6)	Inner PVC (.216) Outer BELFX (.360)	.073	75	16.2	-35 to +75	300
RG-59/U Type Triaxial High-Flex Version	1857A	6.51	Belden	19/.031" BC (14.0)	FPE (.143)	Inner None/95% BC (2.5) Outer None/90% BC (1.6)	Inner PE (.216) Outer BELFX (.360)	.075	75	17.0	-35 to +75	300
RG-59/U Type	8212	6.37	Belden	1/.032" CCS (44.5)	FPE (.143)	None/95% BC (2.6)	PE (.242)	.030	75	17.3	-55 to +80	300
RG-59/U Type	8221	6.36	Belden	1/.0253" BCCS (50.0)	FPE (.146)	None/85% BC (2.6)	PVC (.242)	.032	80	16.3	-40 to +75	300
RG-59/U Type Triaxial	8232	6.51	Belden	1/.032" BC (10.0)	GIFHDPE (.145)	Inner None/95% BC (2.5) Outer None/80% BC (2.8)	Inner PE (.225) Outer PE (.315)	.054	75	16.2	-55 to +80	300
RG-59/U Type Triaxial	8232A	6.51	Belden	1/.032" BC (10.0)	GIFHDPE (.145)	Inner None/98% BC (2.5) Outer None/80% BC (2.8)	Inner PVC (.226) Outer PVC (.315)	.065	75	16.2	-40 to +75	300
RG-59/U Type	8241	6.35	Belden	1/.023" BCCS (49.0)	PE (.146)	None/95% BC (2.6)	PVC (.240)	.036	75	20.5	-40 to +75	1,700

*Inner conductors are entered as: number of strands/strand diameter (in inches).

See page 6.15 for key to abbreviations used in this table.



RG Coaxial and Triaxial Reference Guide

RG-59/U Type

Cable Designation	Part No.	Page No.	Spec. Reference	Conductor Stranding/ Dia. & Type* (DCR/1000 Ft.)	Insulation Material (OD in.)	Shield Type Tape/Braid (DCR/1000 Ft.)	Jacket Material (OD in.)	Nom. Weight (Lbs./Ft.)	Nom. Imp. (Ω)	Nom. Cap. (pF/Ft.)	Suggested Operating Temp. Range (°C) UL	Max. Oper. Voltage (RMS) Non UL
RG-59/U Type (continued)												
RG-59/U Type	8241A	6.35	Belden	1/.023" BCCS (49.0)	FRSFPE (.146)	None/95% BC (2.6)	PVC (.242)	.039	75	20.5	-40 to +75	300
RG-59/U Type	8241B	6.35	Belden	1/.0228" BC (20.0)	PE (.146)	None/95% BC (2.9)	PVC (.242)	.038	75	20.5	-20 to +75	300
RG-59/U Type	8241F	6.35	Belden	7/.030" BC (15.0)	FPE (.146)	None/95% BC (2.6)	PVC (.242)	.033	75	17.3	-30 to +60	300
RG-59B/U Type	8263	6.36	MIL-C-17D	1/.023" BCCS (49.0)	PE (.146)	None/95% BC (2.6)	PVC-NC (.242)	.035	75	20.5	-40 to +60	1,700
RG-59/U Type Precision	8279	6.41	Belden	7/.023" BCC (19.1)	PE (.146)	None/95% TC (4.5)	PE (.220)	.026	75	21.0	-55 to +80	2,300
RG-59/U Type Precision Video	8281	6.30	Belden	1/.031" BC (9.9)	PE (.198)	None/97% TC None/95% TC (1.1)	PE (.305)	.068	75	21.0	-55 to +80	2,900
RG-59/U Type Precision Video	8281B	6.30	Belden	1/.031" BC (9.9)	FRSFPE (.198)	None/97% TC None/95% TC (1.1)	PVC (.305)	.078	75	21.0	-40 to +80	300
RG-59/U Type Precision Video	8281F	6.30	Belden	7/.0315" BCC (12.2)	PE (.198)	None/97% TC None/95% TC (1.7)	PVC (.305)	.060	75	21.0	-20 to +60	2,900
RG-59/U Type	9100	6.16	Belden	1/.032" BCCS (44.5)	GIFPE (.144)	DBII/40% AL (17.0)	PVC (.237)	.020	75	16.2	-40 to +80	300
RG-59/U Type	9104	6.17	Belden	1/.032" BCCS (44.5)	GIFPE (.144)	DBII/67% AL (12.0)	PVC (.237)	.024	75	16.2	-40 to +80	300
RG-59/U Type	9104N	6.17	Belden	1/.032" BCCS (44.5)	GIFPE (.144)	DBII/67% AL (12.0)	PVC (.237)	.024	75	16.2	-40 to +80	300
RG-59/U Type Plenum	9104P	6.17	Belden	1/.032" BCCS (44.5)	FFEP (.140)	DBII/67% AL (12.0)	FLM (.203)	.024	75	16.3	-20 to +75	300
RG-59/U Type	9105M	6.17	Belden	1/.032" BCCS (44.5)	GIFHDPE (.140)	DBII/67% AL (12.0)	PVC (.240 x .387)	.037	75	16.2	-40 to +80	300
RG-59/U Type	9110	6.17	Belden	1/.032" BCCS (44.5)	GIFHDPE (.144)	DBIII/67% AL (12.0)	PVC (.242)	.022	75	16.2	-40 to +80	300
RG-59/U Type Precision Video	9141	6.43	Belden	1/.031" BC (9.9)	PE (.200)	None/97% TC None/95% TC (1.1)	PE (.305)	.069	75	20.0	-55 to +80	1,900
RG-59/U Type	9167	6.29	Belden	1/.032" SPCCS (25.8)	GIFPE (.144)	DB+/95% AL (4.5)	PVC (.242)	.028	75	16.2	-40 to +80	300
RG-59/QPL M17/29-RG59	9204	6.79	MIL-C-17G	1/.023" BCCS (47.0)	PE (.146)	None/95% BC (2.6)	PVC-NC (.241)	.034	75	20.5	-40 to +85	1,700
RG-59/U Type Precision Video	9209	6.41	Belden	1/.023" BC (20.4)	PE (.146)	DF/95% TC (4.5)	PE (.220)	.026	75	21.0	-55 to +80	2,300
RG-59/U Type Precision Video	9209A	6.41	Belden	1/.023" BC (20.4)	FRSFPE (.146)	DF/95% TC (4.5)	PVC (.220)	.035	75	20.5	-40 to +75	300
RG-59/U Type	9224	6.82	Belden	1/.025" BCCS (54.0)	PE (.146)	None/93% BC (2.5)	PVC (.242)	.033	75	22.0	-40 to +75	1,900
RG-59/U Type Precision Video	9231	6.42	W/E 728B	1/.031" BC (9.9)	PE (.198)	None/97% TC None/95% TC (1.1)	PVC (.305)	.071	75	21.0	-40 to +60	1,900
RG-59/U Type	9240	6.37	Belden	1/.032" BCCS (44.5)	FPE (.143)	None/80% BC (5.6)	PVC (.241)	.028	75	17.3	-40 to +75	300
RG-59/U Type	9244	6.36	Belden	1/.025" BCCS (50.0)	PE (.146)	None/85% BC (4.5)	PVC (.242)	.034	75	19.4	-40 to +80	1,700
RG-59/U Type	9259	6.36	Belden	7/.030" BC (15.0)	FPE (.146)	None/95% BC (2.6)	PVC (.241)	.033	75	17.3	-40 to +80	300
RG-59/U Type Triaxial	9267	6.52	Belden	1/.032" BC (10.0)	GIFHDPE (.145)	Inner None/95% BC (2.5) Outer None/80% BC (2.6)	Inner PE (.216) Outer H (.360)	.079	75	16.3	-20 to +80	300

*Inner conductors are entered as: number of strands/strand diameter (in inches).

See page 6.15 for key to abbreviations used in this table.

RG Coaxial and Triaxial Reference Guide

RG-59/U, RG-62 and Other Misc. RG Types

Cable Designation	Part No.	Page No.	Spec. Reference	Conductor Stranding/ Dia. & Type* (DCR/1000 Ft.)	Insulation Material (OD in.)	Shield Type Tape/Braid (DCR/1000 Ft.)	Jacket Material (OD in.)	Nom. Weight (Lbs./Ft.)	Nom. Imp. (Ω)	Nom. Cap. (pF/Ft.)	Suggested Operating Temp. Range (°C) UL	Max. Oper. Voltage (RMS) Non UL
RG-59/U Type (continued)												
RG-59/U Type	9274	6.37	Belden	1/.032" BCCS (44.5)	FPE (.143)	None/95% BC (3.5)	PVC (.240)	.030	75	16.3	-40 to +80	300
RG-59/U Type	9275	6.16	Belden	1/.032" BCCS (44.5)	GIFPE (.144)	DF/40% AL (17.0)	PVC (.237)	.023	75	16.2	-40 to +80	300
RG-59/U Type Dual	9555	6.84	Belden	1/.023" BCCS (50.0)	FRSFPE (.146)	None/95% BC (2.6)	PVC (.238 x .478)	.075	75	20.5	-40 to +80	300
RG-59/U Type	9659	6.36	Belden	7/.030" BC (15.0)	FPE (.146)	None/95% BC (2.6)	PVC-NC (.242)	.032	75	17.3	-40 to +80	300
RG-59/U Type Plenum	82108	6.18	Belden	1/.032" BCCS (26.0)	FFEP (.140)	DF/96% TC (2.6)	FLM (.202)	.035	75	16.5	0 to +75	300
RG-59/U Type Plenum	82241	6.35	Belden	1/.023" BCCS (49.0)	FEP (.134)	None/97% BC (2.6)	FLM (.190)	.035	75	19.5	-20 to +75	1,700
RB-59/U Type Plenum	82259	6.36	Belden	7/.030" BC (15.0)	FFEP (.135)	None/95% BC (2.6)	FLM (.193)	.036	75	17.3	-20 to +75	300
RG-59/U Type Plenum	88241	6.35	Belden	1/.023" BCCS (49.0)	FEP (.132)	None/97% BC (2.6)	FEP (.190)	.037	75	19.5	-70 to +200	1,700
RG-59/U Type Plenum Triax	88232	6.51	Belden	1/.032" BC (32.8)	FFEP (.140)	Inner None/95% BC (2.6) None/95% BC (2.6)	Inner FEP (.188) Outer FEP (.245)	.060	75	16.9	-40 to +200	300
RG-59/U Type Precision Video Plenum	88281	6.43	Belden	1/.032" BC (9.9)	FEP (.185)	None/98% TC None/96% TC (1.1)	PVDF (.271)	.082	75	19.0	-20 to +150	1,900
RG-59/U Type Plenum	89108	6.18	Belden	1/.032" BCCS (26.0)	FFEP (.140)	DF/96% TC (2.6)	FEP (.203)	.035	75	16.5	-70 to +200	300
RG-59/U Type Plenum	89259	6.36	Belden	7/.030" BC (15.0)	FFEP (.135)	None/95% BC (2.6)	FEP (.193)	.036	75	17.3	-70 to +200	300
RG-59/U Type Dual Plenum	89555	6.84	Belden	1/.023" BCCS (50.0)	FEP (.134)	None/97% BC (2.6)	FEP (.212 x .424)	.085	75	19.5	-70 to +200	1,700
RG-62 Type												
RG-62/U Type	8254	6.85	JAN-C-17A	1/.025" BCCS (41.2)	SSPE (.146)	None/95% BC (2.9)	PVC (.238)	.033	93	13.5	-40 to +80	750
RG-62B/U Type	8255	6.85	MIL-C-17D	7/.024" BCCS (59.0)	SSPE (.146)	None/95% BC (2.9)	PVC-NC (.242)	.032	93	13.5	-40 to +80	750
RG-62A/U Type	9228	6.85	Belden	1/.025" BCCS (41.2)	SSPE (.146)	None/95% BC (2.9)	HDPE (.242)	.033	93	13.5	-55 to +80	750
RG-62A/U Type	9268	6.85	Belden, IBM P/N 5252750	1/.025" BCCS (41.2)	SSPE (.146)	None/95% BC (2.9)	PVC (.260)	.037	93	13.5	-40 to +80	750
RG62A/U Type	9269	6.85	Belden, IBM P/N 323921	1/.025" BCCS (41.2)	SSPE (.146)	None/95% BC (2.9)	PVC (.239)	.034	93	13.5	-40 to +80	750
RG-62/QPL M17/30-RG62	9862	6.80	MIL-C-17G	1/.025" BCCS (41.2)	SSPE (.146)	None/95% BC (2.9)	PVC-NC (.242)	.033	93	13.5	-40 to +80	750
RG-62/U Type Plenum	82262	6.86	Belden	1/.025" BCCS (41.2)	FFEP (.146)	None/94% BC (3.4)	FLM (.204)	.035	93	12.5	0 to +75	300
RG-62/U Type Plenum	82269	6.86	Belden	1/.025" BCCS (41.2)	SSFEP (.142)	None/94% BC (3.4)	FLM (.200)	.035	93	12.8	0 to +75	750
RG-62/U Type Plenum	86262	6.86	Belden, IBM	1/.025" BCCS (41.2)	FFEP (.146)	None/94% BC (3.4)	FEP (.204)	.035	93	12.5	-70 to +200	300
RG-62/U Type Plenum	87269	6.86	Belden	1/.025" BCCS (41.2)	SSFEP (.142)	None/94% BC (3.4)	PVDF (.200)	.031	93	12.8	-20 to +150	750
RG-62/U Type Plenum	89269	6.86	Belden, IBM	1/.025" BCCS (41.2)	SSFEP (.142)	None/94% BC (3.4)	FEP (.200)	.033	93	12.8	-70 to +200	750
Other Misc. RG Types												
RG-63/QPL M17/31-RG63	9857	6.80	MIL-C-17G	1/.025" BCCS (41.2)	SSPE (.285)	None/97% BC (1.2)	PVC-NC (.405)	.078	125	9.7	-40 to +80	750
RG-71/QPL M17/90-RG71	9169	6.80	MIL-C-17G	1/.025" BCCS (41.2)	SSPE (.146)	None/95% BC None/95% TC (1.5)	PE (.245)	.042	93	13.5	-55 to +80	750

*Inner conductors are entered as: number of strands/strand diameter (in inches).

See page 6.15 for key to abbreviations used in this table.



RG Coaxial and Triaxial Reference Guide

Misc. RG Types and Miniature Coax

Cable Designation	Part No.	Page No.	Spec. Reference	Conductor Stranding/ Dia. & Type* (DCR/1000 Ft.)	Insulation Material (OD in.)	Shield Type Tape/Braid (DCR/1000 Ft.)	Jacket Material (OD in.)	Nom. Weight (Lbs./Ft.)	Nom. Imp. (Ω)	Nom. Cap. (pF/Ft.)	Suggested Operating Temp. Range (°C) UL	Max. Oper. Voltage (RMS) Non UL
Other Misc. RG Types (continued)												
RG-122/U QPL M17/157-00001	9252	6.76	MIL-C-17G	27/.030" TC (17.1)	PE (.096)	None/95% TC (5.2)	PVC-NC (.160)	.017	50	30.8	-40 to +80	1,400
RG-142B/U QPL M17/158-00001	83242	6.77	MIL-C-17G	1/.037" SCCS (19.3)	TFE (.116)	None/96% SC None/96% SC (2.3)	FEP (.195)	.043	50	29.0	-70 to +200	1,400
RG-142/ QPL M17/60-RG142	84142	6.77	MIL-C-17G	1/.037" SCCS (19.3)	TFE (.116)	None/96% SC None/96% SC (2.3)	FEP (.195)	.043	50	29.0	-70 to +200	1,400
RG-174/U Type RF100	7805	6.59	Belden	1/.018" BC (32.0)	PE (.061)	DF/90% TC (9.1)	PVC (.110)	.010	50	31.2	-40 to +75	1,100
RG-174/U Type RF 100 Low Loss	7805R	6.59	Belden	1/.0195" BC (27.3)	FPE (.060)	DF/90% TC (9.4)	PVC (.110)	.010	50	26.2	-40 to +75	300
RG-174/U Type	8216	6.67	MIL-C-17F	7/.019" BCCS (97.0)	PE (.060)	None/90% TC (10.7)	PVC (.110)	.008	50	30.8	-40 to +75	1,100
RG-174/U Type	9239	6.82	Belden	7/.019" BCCS (97.0)	PE (.044)	None/90% TC (14.0)	PVC (.101)	.008	50	38.0	-40 to +60	1,100
RG-178B/U QPL M17/169-00001	83265	6.76	MIL-C-17G	7/.012" SPCCS (244.0)	TFE (.033)	None/95% SPC (14.6)	FEP (.071)	.005	50	29.0	-70 to +200	750
RG-179/QPL M17/94-RG179	83264	6.79	MIL-C-17G	7/.012" SPCCS (244.0)	TFE (.062)	None/94% SPC (8.5)	FEP (.100)	.010	75	19.5	-70 to +200	900
RG-180/QPL M17/95-RG180	83266	6.80	MIL-C-17G	7/.012" SPCCS (244.0)	TFE (.102)	None/91% SPC (6.5)	FEP (.141)	.018	95	15.0	-70 to +200	1,100
RG-187A/U Type	83267	6.84	MIL-C-17D	7/.012" SPCCS (244.0)	TFE (.063)	None/95% SPC (8.6)	TFE-T (.103)	.010	75	19.5	-70 to +200	900
RG-188A/U Type	83269	6.67	MIL-C-17D	7/.020" SPCCS (91.2)	TFE (.058)	None/96% SPC (8.5)	TFE-T (.098)	.011	50	29.0	-70 to +200	900
RG-212/U QPL M17/162-00001	9861	6.78	MIL-C-17G	1/.056" SPC (3.3)	PE (.185)	None/95% SPC None/95% SC (1.1)	PVC-NC (.332)	.081	50	30.8	-50 to +80	2,200
RG-213/U QPL M17/163-00001	8267	6.78	MIL-C-17G	7/.089" BC (1.7)	PE (.285)	None/96% BC (1.2)	PVC-NC (.405)	.102	50	30.8	-40 to +80	3,700
RG-214/U QPL M17/164-00001	8268	6.78	MIL-C-17G	7/.089" SPC (1.7)	PE (.285)	None/97% SPC None/97% SPC (.7)	PVC-NC (.425)	.128	50	30.8	-40 to +80	3,700
RG-216/QPL M17/77-RG216	9850	6.79	MIL-C-17G	7/.048" TC (6.1)	PE (.285)	None/95% BC None/95% BC (.8)	PVC-NC (.425)	.122	75	20.5	-40 to +80	3,700
RG-223/U QPL M17/167-00001	9273	6.77	MIL-C-17G	1/.034" SCC (8.8)	PE (.117)	None/95% SCC None/95% SCC (2.5)	PVC-NC (.212)	.036	50	30.8	-40 to +60	1,400
RG-303/QPL M17/111-RG303	84303	6.77	MIL-C-17G	1/.037" SPCCS (16.3)	TFE (.116)	None/95% SCC (4.3)	FEP (.170)	.030	50	29.0	-70 to +200	1,400
RG-316/U QPL M17/172-00001	83284	6.76	MIL-C-17G	7/.020" SPCCS (84.1)	TFE (.058)	None/95% SPC (6.5)	FEP (.098)	.010	50	29.0	-70 to +200	900
RG-316/QPL M17/113-RG316	84316	6.76	MIL-C-17G	7/.020" SPCCS (84.1)	TFE (.058)	None/95% SPC (6.5)	FEP (.098)	.010	50	29.0	-70 to +200	900
Miniature Coax												
Miniature Coax	8218	6.34	Belden	7/.017" BCCS (120.0)	PE (.100)	None/93% TC (5.7)	PVC (.150)	.014	75	20.5	-40 to +60	1,700
Miniature Coax	8700	6.82	Belden	1/.013" TC (66.9)	PP (.023)	None/90% BC (28.7)	PVC (.054)	.003	32	55.2	-30 to +105	300
Miniature Coax	9221	6.34	Belden	7/.012" TC (100.0)	FHDPE (.058)	None/89% TC (11.7)	PVC (.097)	.006	75	17.3	-40 to +60	30
Miniature RG-59/U Type	1855A	6.40	Belden	1/.023" BC (20.1)	GIFHDPE (.102)	DF/95% TC (7.6)	PVC (.159)	.018	75	16.3	-30 to +75	300
Sub-Miniature RG-59/U Type	1865A	6.40	Belden	19/.021" BC (27.4)	GIFHDPE (.094)	DF/95% TC (5.4)	PVC (.150)	.014	75	16.5	-40 to +75	300

*Inner conductors are entered as: number of strands/strand diameter (in inches).

See page 6.15 for key to abbreviations used in this table.

RG Coaxial and Triaxial Reference Guide

Bundled Coax

Cable Designation	Part No.	No. of Coax	Page No.	Spec. Reference	Conductor Stranding/ Dia. & Type* (DCR/1000 Ft.)	Insulation Material (OD in.)	Shield Type Tape/Braid (DCR/1000 Ft.)	Jacket Material (OD in.)	Nom. Weight (Lbs./Ft.)	Nom. Imp. (Ω)	Nom. Cap. (pF/Ft.)	Suggested Operating Temp. Range (°C) UL	Max. Oper. Voltage (RMS) Non UL
Bundled Coax													
Bundled Coax Sub-Miniature RGB	1520A	3	6.47	Belden	7/.012" TC (100.0)	FHDPE (.056)	DF/90% TC (9.5)	PVC (.283)	.042	75	17.3	-40 to +60	300
Bundled Coax Sub-Miniature RGB	1521A	4	6.47	Belden	7/.012" TC (100.0)	FHDPE (.056)	DF/90% TC (9.5)	PVC (.310)	.050	75	17.3	-40 to +60	300
Bundled Coax Sub-Miniature RGB	1522A	5	6.47	Belden	7/.012" TC (100.0)	FHDPE (.056)	DF/90% TC (9.5)	PVC (.338)	.058	75	17.3	-40 to +60	300
Bundled Coax Miniature RGB	1406B	3	6.47	Belden	7/.019" BC (41.5)	FHDPE (.090)	DF/93% TC (8.6)	PVC (.388)	.064	75	17.3	-40 to +60	300
Bundled Coax Miniature RGB	1407B	4	6.47	Belden	7/.019" BC (41.5)	FHDPE (.090)	DF/93% TC (8.6)	PVC (.455)	.088	75	17.3	-40 to +60	300
Bundled Coax Miniature RGB	1417B	5	6.47	Belden	7/.019" BC (41.5)	FHDPE (.090)	DF/93% TC (8.6)	PVC (.477)	.102	75	17.3	-40 to +60	300
Bundled Coax RGB	1164B	3	6.48	Belden	7/.019" BC (41.5)	FHDPE (.090)	DF/93% TC (8.6)	PVC (.388)	.066	75	17.3	-40 to +60	300
Bundled Coax RGB	1167B	4	6.48	Belden	7/.019" BC (41.5)	FHDPE (.090)	DF/93% TC (8.6)	PVC (.455)	.090	75	17.3	-40 to +60	300
Bundled Coax RGB	1418B	5	6.48	Belden	7/.019" BC (41.5)	FHDPE (.090)	DF/93% TC (8.6)	PVC (.477)	.104	75	17.3	-40 to +60	300
Bundled Coax RGB	1277R	3	6.48	Belden	1/.018" TC (34.0)	FPFA (.074)	DB/95% TC (5.4)	PVC (.320)	.048	75	17.0	-40 to +75	300
Bundled Coax RGB	1278R	4	6.48	Belden	1/.018" TC (34.0)	FPFA (.074)	DB/95% TC (5.4)	PVC (.351)	.060	75	17.0	-40 to +75	300
Bundled Coax RGB	1279R	5	6.48	Belden	1/.018" TC (34.0)	FPFA (.074)	DB/95% TC (5.4)	PVC (.403)	.080	75	17.0	-40 to +75	300
Bundled Coax RGB	1280R	6	6.48	Belden	1/.018" TC (34.0)	FPFA (.074)	DB/95% TC (5.4)	PVC (.423)	.087	75	17.0	-40 to +75	300
Bundled Coax RGB Plenum	1277P	3	6.48	Belden	1/.018" TC (34.0)	FPFA (.074)	DB/95% TC (5.4)	PVC (.276)	.043	75	16.8	-20 to +75	300
Bundled Coax RGB Plenum	1278P	4	6.48	Belden	1/.018" TC (34.0)	FPFA (.074)	DB/95% TC (5.4)	PVC (.304)	.053	75	16.8	-20 to +75	300
Bundled Coax RGB Plenum	1279P	5	6.48	Belden	1/.018" TC (34.0)	FPFA (.074)	DB/95% TC (5.4)	PVC (.335)	.068	75	16.8	-20 to +75	300
Bundled Coax RGB Plenum	1280P	6	6.48	Belden	1/.018" TC (34.0)	FPFA (.074)	DB/95% TC (5.4)	PVC (.369)	.079	75	16.8	-20 to +75	300
Bundled Coax RGB BananaPeel®	1281S3	3	6.49	Belden	1/.018" TC (34.0)	GIFHDPE (.074)	DB/95% TC (5.4)	PVC (.246)	.031	75	17.0	-40 to +75	300
Bundled Coax RGB BananaPeel	1281S4	4	6.49	Belden	1/.018" TC (34.0)	GIFHDPE (.074)	DB/95% TC (5.4)	PVC (.275)	.044	75	17.0	-40 to +75	300
Bundled Coax RGB BananaPeel	1281S5	5	6.49	Belden	1/.018" TC (34.0)	GIFHDPE (.074)	DB/95% TC (5.4)	PVC (.308)	.055	75	17.0	-40 to +75	300
Bundled Coax RGB BananaPeel	1281S6	6	6.49	Belden	1/.018" TC (34.0)	GIFHDPE (.074)	DB/95% TC (5.4)	PVC (.342)	.068	75	17.0	-40 to +75	300
Bundled Coax RGB BananaPeel Plenum	1282S3	3	6.49	Belden	1/.018" TC (34.0)	FPFA (.075)	DB/95% TC (5.4)	FLM (.246)	.034	75	16.8	-20 to +75	300
Bundled Coax RGB BananaPeel Plenum	1282S4	4	6.49	Belden	1/.018" TC (34.0)	FPFA (.075)	DB/95% TC (5.4)	FLM (.275)	.049	75	16.8	-20 to +75	300
Bundled Coax RGB BananaPeel Plenum	1282S5	5	6.49	Belden	1/.018" TC (34.0)	FPFA (.075)	DB/95% TC (5.4)	FLM (.308)	.067	75	16.8	-20 to +75	300
Bundled Coax RGB BananaPeel Plenum	1282S6	6	6.49	Belden	1/.018" TC (34.0)	FPFA (.075)	DB/95% TC (5.4)	FLM (.342)	.080	75	16.8	-20 to +75	300

*Inner conductors are entered as: number of strands/strand diameter (in inches).

See page 6.15 for key to abbreviations used in this table.



RG Coaxial and Triaxial Reference Guide

Bundled and S-Video Coax

Cable Designation	Part No.	No. of Coax	Page No.	Spec. Reference	Conductor Stranding/Dia. & Type* (DCR/1000 Ft.)	Insulation Material (OD in.)	Shield Type Tape/Braid (DCR/1000 Ft.)	Jacket Material (OD in.)	Nom. Weight (Lbs./Ft.)	Nom. Imp. (Ω)	Nom. Cap. (pF/Ft.)	Suggested Operating Temp. Range (°C) UL	Max. Oper. Voltage (RMS) Non UL
Bundled Coax (continued)													
RG-6 Type Bundled SDI Coax	7710A	3	6.46	Belden	1/.040" BC (6.4)	GIFPE (.180)	DF/95% TC (3.0)	PVC-M (.770)	.234	75	16.2	-40 to +75	300
RG-6 Type Bundled SDI Coax	7711A	4	6.46	Belden	1/.040" BC (6.4)	GIFPE (.180)	DF/95% TC (3.0)	PVC-M (.900)	.303	75	16.2	-40 to +75	300
RG-6 Type Bundled SDI Coax	7712A	5	6.46	Belden	1/.040" BC (6.4)	GIFPE (.180)	DF/95% TC (3.0)	PVC-M (.970)	.371	75	16.2	-40 to +75	300
RG-6 Type Bundled SDI Coax	7713A	10	6.46	Belden	1/.040" BC (6.4)	GIFPE (.180)	DF/95% TC (3.0)	PVC-M (1.386)	.772	75	16.2	-40 to +75	300
RG-59/U Type Bundled (Miniature)	7787A	3	6.45	Belden	1/.023" BC (20.1)	GIFHDPE (.102)	DF/95% TC (7.6)	PVC (.432)	.081	75	16.5	-35 to +75	300
RG-59/U Type Bundled (Miniature)	7788A	4	6.45	Belden	1/.023" BC (20.1)	GIFHDPE (.102)	DF/95% TC (7.6)	PVC (.481)	.106	75	16.5	-35 to +75	300
RG-59/U Type Bundled (Miniature)	7789A	5	6.45	Belden	1/.023" BC (20.1)	GIFHDPE (.102)	DF/95% TC (7.6)	PVC (.539)	.133	75	16.5	-35 to +75	300
RG-59/U Type Bundled (Miniature)	7790A	6	6.45	Belden	1/.023" BC (20.1)	GIFHDPE (.102)	DF/95% TC (7.6)	PVC (.597)	.163	75	16.5	-35 to +75	300
RG-59/U Type Bundled (Miniature)	7791A	12	6.45	Belden	1/.023" BC (20.1)	GIFHDPE (.102)	DF/95% TC (7.6)	PVC (.796)	.280	75	16.5	-35 to +75	300
RG-59/U Type Bundled (Miniature)	7792A	12	6.45	Belden	1/.023" BC (20.1)	GIFHDPE (.102)	DF/95% TC (7.6)	PVC (.825)	.336	75	16.5	-35 to +75	300
RG-59/U Type Bundled	7794A	3	6.45	Belden	1/.032" BC (10.0)	GIFHDPE (.145)	DF/95% TC (3.8)	PVC (.631)	.084	75	16.3	-35 to +75	300
RG-59/U Type Bundled	7795A	4	6.45	Belden	1/.032" BC (10.0)	GIFHDPE (.145)	DF/95% TC (3.8)	PVC (.706)	.190	75	16.3	-35 to +75	300
RG-59/U Type Bundled	7796A	5	6.45	Belden	1/.032" BC (10.0)	GIFHDPE (.145)	DF/95% TC (3.8)	PVC (.790)	.238	75	16.3	-35 to +75	300
RG-59/U Type Bundled	7798A	10	6.45	Belden	1/.032" BC (10.0)	GIFHDPE (.145)	DF/95% TC (3.8)	PVC (1.166)	.501	75	16.3	-35 to +75	300
RG-59/U Type Bundled RGB Coax BananaPeel Plenum	1283S3	3	6.46	Belden	1/.032" TC (10.0)	FFEP (.133)	DF/95% TC (3.8)	PVC (.422)	.103	75	16.2	-20 to +75	300
RG-59/U Type Bundled RGB Coax BananaPeel Plenum	1283S5	5	6.46	Belden	1/.032" TC (10.0)	FFEP (.133)	DF/95% TC (3.8)	PVC (.529)	.174	75	16.2	-20 to +75	300
RG-59/U Type Bundled RGB Coax BananaPeel Plenum	1283S6	6	6.46	Belden	1/.032" TC (10.0)	FFEP (.133)	DF/95% TC (3.8)	PVC (.588)	.209	75	16.2	-20 to +75	300
S-Video Coax													
Parallel Coax S-Video Plenum	7700A	2	6.50	Belden	7/.012" TC (100.0)	FFEP (.053)	None/98% TC (7.5)	FLM (.107 x .214)	.017	75	17.3	-20 to +60	300
Parallel Coax S-Video High-Flex	1807A	2	6.50	Belden	7/.012" TC (100.0)	FHDPE (.056)	None/90% TC (7.5)	PVC (.110 x .230)	.013	75	17.3	-40 to +75	300
Round S-Video High-Flex Design	1808A	2	6.50	Belden	7/.012" TC (100.0)	FHDPE (.056)	None/90% TC (7.5)	PVC (.255)	.031	75	17.3	-40 to +75	300

*Inner conductors are entered as: number of strands/strand diameter (in inches).

Conductor Abbreviations

BC = Bare Copper
 BCCA = Bare Copper-covered Aluminum
 CCS = Copper-clad Steel
 SC = Silver-coated Copper
 SCA = Silver-coated Alloy
 SCCS = Silver-coated Copper-covered Steel
 SPC = Silver-plated Copper
 SPCCS = Silver-plated Copper-covered Steel
 TC = Tinned Copper

Braid Abbreviations

AL = Aluminum
 BC = Bare Copper
 CT = Copper-Tin Composite
 SC = Silver-coated Copper
 SPC = Silver-plated Copper
 TC = Tinned Copper

Tape Abbreviations

BB = Bonded Beldfoil®
 BF = Beldfoil
 DB = Duobond®
 DBII = Duobond II
 DBIII = Duobond III
 DBIV = Duobond IV
 DB+ = Duobond Plus®
 DF = Duofoil®
 F = Foil

Insulation Abbreviations

FEP = Fluorinated Ethylene Propylene
 FPEP = Foam FEP
 FHDPE = Foam High-Density Polyethylene
 FPE = Foam Polyethylene
 FRSFPE = Flame-retardant Semi-foam Polyethylene
 GIFHDPE = Gas-injected Foam High-Density Polyethylene
 GIFPE = Gas-injected Foam Polyethylene
 PE = Solid Polyethylene
 PP = Solid Polypropylene
 SSFEP = Semi-solid FEP
 SSPE = Semi-solid Polyethylene
 TFE = Tetrafluoroethylene

Jacket Abbreviations

BELFX = Belflex®
 FCP = Fluorocopolymer
 FEP = Fluorinated Ethylene Propylene
 FG = Fiberglass
 FLM = Flamarrist®
 H = Hypalon®
 HDPE = High-density Polyethylene
 LSZH = Low-Smoke, Zero-Halogen
 PE = Polyethylene
 PVC = Polyvinyl Chloride
 PVC-M = Matte finish Polyvinyl Chloride
 PVC-NC = Non-contaminating Polyvinyl Chloride
 TFE-T = Tetrafluoroethylene Tape Wrap

Hypalon is a DuPont trademark.

For information on coaxial cables not listed in this table, or for a comprehensive Connector Cross-Reference, please contact Belden Electronics Division, Technical Support at: **1-800-BELDEN-1**.



For more information, contact Belden Technical Support: 1-800-BELDEN-1 • www.belden.com

Broadband Coax

MATV Cables

Series 59

Description	Part No.	UL NEC/ C(UL) CEC Type	Standard Lengths		Standard Unit Weight		Conductor (stranding) Diameter Nom. DCR	Nominal Core OD		Shielding Materials Nom. DCR	Nominal OD		Nom. Imp. (Ω)	Nom. Vel. of Prop.	Nominal Capacitance		Nominal Attenuation		
			Ft.	m	Lbs.	kg		Inch	mm		Inch	mm			pF/Ft.	pF/m	MHz	dB/100 Ft.	dB/100m

Series 59 • 20 AWG Solid .032" Bare Copper-covered Steel Conductor • Foil + Braid Shield (40% Coverage)

Gas-injected Foam Polyethylene Insulation • Black PVC Jacket

80°C	9275	NEC: CATV CM	U-500	U-152.4	12.0	5.5	20 AWG (solid)	.144	3.66	Duofoil® + 40% Aluminum Braid	.237	6.02	75	83%	16.2	53.1	See Chart on page 6.92		
		CEC: CM	U-1000 [▲]	U-304.8	23.0	10.4	.032" BCCS										Sweep tested 5 MHz to 550 MHz.		
							44.5Ω/M'										146.0Ω/km		

[▲]U-1000 ft. put-up also available in White.

80°C	9100	NEC: CATV CM	U-500	U-152.4	12.0	5.5	20 AWG (solid)	.144	3.66	Duobond® II* + 40% Aluminum Braid	.237	6.02	75	83%	16.2	53.1	See Chart on page 6.92		
		CEC: CM	U-1000 [▲]	U-304.8	23.0	10.4	.032" BCCS										Sweep tested 5 MHz to 1 GHz.		
							44.5Ω/M'										146.0Ω/km		

[▲]U-1000 ft. put-up also available in White.

BCCS = Bare Copper-covered Steel • DCR = DC Resistance

*Duobond II = Bonded Duofoil® (100% coverage) + aluminum braid (67% coverage).

Broadband Coax

CATV Cables

Series 59

Description	Part No.	UL NEC/ C(UL) CEC Type	Standard Lengths		Standard Unit Weight		Conductor (stranding) Diameter Nom. DCR	Nominal Core OD		Shielding Materials Nom. DCR	Nominal OD		Nom. Imp. (Ω)	Nom. Vel. of Prop.	Nominal Capacitance		Nominal Attenuation		
			Ft.	m	Lbs.	kg		Inch	mm		Inch	mm			pF/Ft.	pF/m	MHz	dB/ 100 Ft.	dB/ 100m

Series 59 • 20 AWG Solid .032" Bare Copper-covered Steel Conductor • Duobond® + Aluminum Braid(s) Shield (67% Coverage)

Gas-injected Foam Polyethylene Insulation • Black PVC Jacket

80°C	9104	NEC: CATV CM CEC: CM	U-1000 [▲] 1000 [▲]	U-304.8 304.8	24.0 24.0	10.9 10.9	20 AWG (solid) .032" BCCS 44.5Ω/M' 146.0Ω/km	.144	3.66	Duobond II* + 67% Aluminum Braid 12.0Ω/M' 39.4Ω/km	.237	6.02	75	83%	16.2	53.1	See Chart on page 6.92		
------	-------------	-------------------------------	--	------------------	--------------	--------------	---	------	------	---	------	------	----	-----	------	------	---------------------------	--	--

[▲]U-1000 ft. put-ups also available in Beige and White.
[▲]1000 ft. put-up available in Black only.

80°C	9104N	—	1000 [*]	304.8	24.0	10.9	20 AWG (solid) .032" BCCS 44.5Ω/M' 146.0Ω/km	.144	3.66	Duobond II* + 67% Aluminum Braid 12.0Ω/M' 39.4Ω/km	.237	6.02	75	83%	16.2	53.1	See Chart on page 6.92		
------	--------------	---	-------------------	-------	------	------	---	------	------	---	------	------	----	-----	------	------	---------------------------	--	--

^{*}1000 ft. put-up also available in White.

Plenum • Foam FEP Teflon® Insulation • Natural Flamarrest® Jacket

75°C	9104P	NEC: CATV CP CEC: CMP	1000 [†]	304.8	24.0	10.9	20 AWG (solid) .032" BCCS 44.5Ω/M' 146.0Ω/km	.140	3.56	Duobond II* + 67% Aluminum Braid 12.0Ω/M' 39.4Ω/km	.203	5.16	75	83%	16.3	53.5	1 10 50 100 200 400 700 900 1000	.4 .8 1.8 2.6 3.8 5.6 7.6 8.8 9.4	1.3 2.6 5.9 8.5 12.5 18.4 24.9 28.9 30.8
------	--------------	--------------------------------	-------------------	-------	------	------	---	------	------	---	------	------	----	-----	------	------	--	---	--

Sweep tested 5 MHz to 1 GHz.

Gas-injected Foam High-Density Polyethylene Insulation • Black PVC Jacket

Aerial 80°C	9105M new		1000	304.8	38.0	17.3	20 AWG (solid) .032" BCCS 44.5Ω/M' 146.0Ω/km	.144	3.66	Duobond II* + 67% Aluminum Braid 12.0Ω/M' 39.4Ω/km	.240 x .387	6.10 x 9.83	75	83%	16.2	53.1	See Chart on page 6.92		
----------------	----------------------------	--	------	-------	------	------	---	------	------	---	-------------------	-------------------	----	-----	------	------	---------------------------	--	--

Sweep tested 5 MHz to 1 GHz.

80°C	9110	NEC: CATV CM CEC: CM	U-1000 [▲]	U-304.8	24.0	10.9	20 AWG (solid) .032" BCCS 44.5Ω/M' 146.0Ω/km	.144	3.66	Duobond III* + 67% Aluminum Braid 12.0Ω/M' 39.4Ω/km	.242	6.15	75	83%	16.2	53.1	See Chart on page 6.92		
------	-------------	-------------------------------	---------------------	---------	------	------	---	------	------	--	------	------	----	-----	------	------	---------------------------	--	--

[▲]U-1000 ft. put-up available in White only.

Sweep tested 5 MHz to 1 GHz.

80°C	1186A	NEC: CATV CM CEC: CM	1000	304.8	27.0	12.3	20 AWG (solid) .032" BCCS 44.5Ω/M' 146.0Ω/km	.144	3.66	Duobond IV* + 67% & 46% Aluminum Braids 7.0Ω/M' 23.0Ω/km	.265	6.73	75	83%	16.2	53.1	See Chart on page 6.92		
------	--------------	-------------------------------	------	-------	------	------	---	------	------	---	------	------	----	-----	------	------	---------------------------	--	--

Sweep tested 5 MHz to 1 GHz.

BCCS = Bare Copper-covered Steel • DCR = DC Resistance • FEP = Fluorinated Ethylene Propylene

Contact the Belden Customer Service Department for a Comprehensive Connector Cross Reference. **1-800-BELDEN-1**.

*Duobond II = Bonded Duofoil® (100% coverage) + aluminum braid (67% coverage).

Duobond III = Bonded Duofoil (100% coverage) + aluminum braid (67% coverage) + Duofoil (100% coverage).

Duobond IV = Bonded Duofoil (100% coverage) + aluminum braid(67% coverage) + Duofoil (100% coverage) + aluminum braid (46% coverage).

[†]Spools and/or UnReel® cartons are one piece, but length may vary ±10% for spools and ±5% for UnReel from length shown.

Teflon is a DuPont trademark.



For more information, contact **Belden Technical Support: 1-800-BELDEN-1 • www.belden.com**

Broadband Coax

CATV Cables

Series 59

Description	Part No.	UL NEC/ C(UL) CEC Type	Standard Lengths		Standard Unit Weight		Conductor (stranding) Diameter Nom. DCR	Nominal Core OD		Shielding Materials Nom. DCR	Nominal OD		Nom. Imp. (Ω)	Nom. Vel. of Prop.	Nominal Capacitance		Nominal Attenuation		
			Ft.	m	Lbs.	kg		Inch	mm		Inch	mm			pF/Ft.	pF/m	MHz	dB/100 Ft.	dB/100m

Series 59 • 20 AWG Solid .032" Bare Copper-covered Steel Conductor • Duofoil® (100% Coverage) + TC Braid Shield(s) (96% Coverage)

Plenum • Foam FEP Teflon® Insulation • Black FEP Jacket

	200°C	89108	NEC:	500 [†]	152.4	17.0	7.7	20 AWG	.140	3.56	Duofoil	.203	5.16	75	82%	16.5	54.1	10	.7	2.3
			CATVP	1000 [†]	304.8	34.0	15.4	(solid)			+ 96%							50	1.8	5.9
			CMP					.032"			TC Braid							100	2.6	8.5
			CEC:					BCCS			2.6Ω/M'							200	3.7	12.1
			CMP					26.0Ω/M'			8.5Ω/km			Sweep tested 5 MHz to 400 MHz.				400	5.4	17.7
								85.3Ω/km										700	7.3	24.0
																		900	8.4	27.6
																	1000	8.9	29.2	

Plenum • Foam FEP Teflon Insulation • Natural Flamarrest® Jacket

	75°C	82108	NEC:	U-1000 [†]	U-304.8	34.0	15.4	20 AWG	.140	3.56	Duofoil	.202	5.13	75	82%	16.5	54.1	10	.8	2.6
			CATVP	1000 [†]	304.8	32.0	14.5	(solid)			+ 96%							50	1.8	5.9
			CMP					.032"			TC Braid							100	2.6	8.5
			CEC:					BCCS			2.6Ω/M'							200	3.7	12.1
			CMP FT6,					26.0Ω/M'			8.5Ω/km			Sweep tested 5 MHz to 400 MHz.				400	5.4	17.7
			CXC FT4					85.3Ω/km										700	7.3	24.0
																		900	8.4	27.6
																	1000	8.9	29.2	

Plenum • Foam FEP Teflon Insulation • Snow Beige FEP Jacket

	200°C	1151A	NEC:	1000 [†]	304.8	40.0	18.2	20 AWG	.140	3.56	(2) Duofoil	.236	5.99	75	84%	16.5	54.1	10	.8	2.6
			CMP					(solid)			Shields							50	1.8	5.9
			CEC:					.032"			+ (2) TC							100	2.6	8.5
			CMP FT6					BCCS			Braids							200	3.7	12.1
								26.0Ω/M'			2.3Ω/M'			Sweep tested 5 MHz to 400 MHz.				400	5.4	17.7
								85.3Ω/km			7.5Ω/km							700	7.3	24.0
																		900	8.4	27.6
																	1000	8.9	29.2	

BCCS = Bare Copper-covered Steel • DCR = DC Resistance • FEP = Fluorinated Ethylene Propylene • TC = Tinned Copper

[†]Spools and/or UnReel® cartons are one piece, but length may vary ±10% from length shown.

Teflon is a DuPont trademark.



For more information, contact Belden Technical Support: 1-800-BELDEN-1 • www.belden.com

Broadband Coax

CATV Cables

Series 6

Description	Part No.	UL NEC/ C(UL) CEC Type	Standard Lengths		Standard Unit Weight		Conductor (stranding) Diameter Nom. DCR	Nominal Core OD		Shielding Materials Nom. DCR	Nominal OD		Nom. Imp. (Ω)	Nom. Vel. of Prop.	Nominal Capacitance		Nominal Attenuation		
			Ft.	m	Lbs.	kg		Inch	mm		Inch	mm			pF/Ft.	pF/m	MHz	dB/ 100 Ft.	dB/ 100m

Series 6 • 18 AWG Solid .040" Bare Copper-covered Steel Conductor • Duobond® II + Aluminum Braid Shield (60% Coverage)

Gas-injected Foam Polyethylene Insulation • Polyethylene Jacket (Black or Orange)

80°C	9066	—	1000	304.8	26.0	11.8	18 AWG (solid) .040" 28.0Ω/M' 91.9Ω/km	.180	4.57	Duobond II* + 60% Aluminum Braid 9.0Ω/M' 29.5Ω/km	.270	6.86	75	83%	16.2	53.1	See Chart on page 6.92		
------	-------------	---	------	-------	------	------	--	------	------	--	------	------	----	-----	------	------	---------------------------	--	--

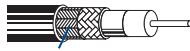

CoreGuard®

Gas-injected Foam Polyethylene Insulation • Black PVC Jacket

80°C	9116	NEC: CATV CM CEC: CM	U-500 ▲ 500 ▲ S-700 U-1000 ♦ 1000 ▼	U-152.4 U-152.4 U-213.4 U-304.8 U-304.8	15.0 16.0 18.2 30.0 31.0	6.8 7.3 8.3 13.6 14.1	18 AWG (solid) .040" 28.0Ω/M' 91.9Ω/km	.180	4.57	Duobond II* + 60% Aluminum Braid 9.0Ω/M' 29.5Ω/km	.270	6.86	75	83%	16.2	53.1	See Chart on page 6.92		
------	-------------	----------------------------------	---	---	--------------------------------------	-----------------------------------	--	------	------	--	------	------	----	-----	------	------	---------------------------	--	--

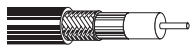

*500 ft. and U-500 ft. put-ups also available in White.
 *U-1000 ft. put-up also available in White, Neutral or Beige.
 *1000 ft. put-up also available in White or Neutral.

80°C	9116R	NEC: CATVR CMG CEC: CMG FT4	U-1000 1000	U-304.8 U-304.8	33.0 34.0	15.0 15.4	18 AWG (solid) .040" 28.0Ω/M' 91.9Ω/km	.180	4.57	Duobond II* + 60% Aluminum Braid 9.0Ω/M' 29.5Ω/km	.270	6.86	75	83%	16.2	53.1	See Chart on page 6.92		
------	--------------	---	----------------	--------------------	--------------	--------------	--	------	------	--	------	------	----	-----	------	------	---------------------------	--	--

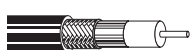

80°C	1545A	NEC: CATV CM CEC: CM	1000	304.8	31.0	14.1	18 AWG (solid) .040" 28.0Ω/M' 91.9Ω/km	.180	4.57	Duobond II* + 60% Aluminum Braid 9.0Ω/M' 29.5Ω/km	.270	6.86	75	83%	16.2	53.1	See Chart on page 6.92 Sweep tested 5 MHz to 1 GHz.		
------	--------------	----------------------------------	------	-------	------	------	--	------	------	--	------	------	----	-----	------	------	---	--	--

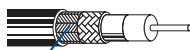

CoreGuard®

80°C	9077	NEC: CATV CM CEC: CM	1000	304.8	64.0	29.1	18 AWG (solid) .040" 28.0Ω/M' 91.9Ω/km	.180	4.57	Duobond II* + 60% Aluminum Braid 9.0Ω/M' 29.5Ω/km	.270 x .590	6.86 x 14.99	75	83%	16.2	53.1	See Chart on page 6.92 Sweep tested 5 MHz to 1 GHz.		
------	-------------	----------------------------------	------	-------	------	------	--	------	------	--	-------------------	--------------------	----	-----	------	------	---	--	--

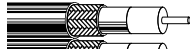

80°C	9117M	—	1000	304.8	44.0	20.0	18 AWG (solid) .040" 28.0Ω/M' 91.9Ω/km	.180	4.57	Duobond II* + 60% Aluminum Braid 9.0Ω/M' 29.5Ω/km	.270 x .410	6.86 x 10.41	75	83%	16.2	53.1	See Chart on page 6.92		
------	--------------	---	------	-------	------	------	--	------	------	--	-------------------	--------------------	----	-----	------	------	---------------------------	--	--

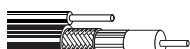

.051" (1.3mm) galvanized steel messenger.

80°C	1258AM	—	1000	304.8	42.0	19.1	18 AWG (solid) .040" 28.0Ω/M' 91.9Ω/km	.180	4.57	Duobond II* + 60% Aluminum Braid 9.0Ω/M' 29.5Ω/km	.270 x .410	6.86 x 10.41	75	83%	16.2	53.1	See Chart on page 6.92 Sweep tested 5 MHz to 1 GHz.		
------	---------------	---	------	-------	------	------	--	------	------	--	-------------------	--------------------	----	-----	------	------	---	--	--



.051" (1.3mm) galvanized steel messenger.

Gas-injected Foam Polyethylene Insulation • Black Low-Smoke, Zero-Halogen Jacket

75°C	9116SB LSZH and ABS Type Approved new	NEC: CMG-LS CEC: CMG-LS FT4 Limited Smoke	1000	304.8	31.0	14.1	18 AWG (solid) .040" 28.0Ω/M' 91.9Ω/km	.180	4.57	Duobond II* + 60% Aluminum Braid 9.0Ω/M' 29.5Ω/km	.274	6.96	75	83%	16.2	53.1	See Chart on page 6.92 Sweep tested 5 MHz to 3 GHz.		
------	--	--	------	-------	------	------	--	------	------	--	------	------	----	-----	------	------	---	--	--

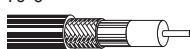

Plenum • Foam FEP Insulation • Natural Flamarrest® Jacket

75°C	9116P	NEC: CATVP CMP CEC: CMP FT6	U-1000 1000	U-304.8 U-304.8	27.0 27.0	12.3 12.3	18 AWG (solid) .040" 28.0Ω/M' 91.9Ω/km	.170	4.32	Duobond II* + 60% Aluminum Braid 9.0Ω/M' 29.5Ω/km	.235	5.97	75	83%	16.3	53.5	1 10 50 100 200 400 700 900 1000	.3 .7 1.6 2.2 3.0 4.6 6.6 7.7 8.2	1.0 2.2 5.3 7.2 9.8 15.1 21.7 25.3 26.9
------	--------------	---	----------------	--------------------	--------------	--------------	--	------	------	--	------	------	----	-----	------	------	--	---	---



BCCS = Bare Copper-covered Steel • DCR = DC Resistance • FEP = Fluorinated Ethylene Propylene
 Contact the Belden Customer Service Department for a Comprehensive Connector Cross Reference. **1-800-BELDEN-1**.
 *Duobond II = Bonded Duofoil® (100% coverage) + aluminum braid (67% coverage).



For more information, contact **Belden Technical Support: 1-800-BELDEN-1 • www.belden.com**

Broadband Coax

CATV Cables

Series 6

Description	Part No.	UL NEC/ C(UL) CEC Type	Standard Lengths		Standard Unit Weight		Conductor (stranding) Diameter Nom. DCR	Nominal Core OD		Shielding Materials Nom. DCR	Nominal OD		Nom. Imp. (Ω)	Nom. Vel. of Prop.	Nominal Capacitance		Nominal Attenuation		
			Ft.	m	Lbs.	kg		Inch	mm		Inch	mm			pF/Ft.	pF/m	MHz	dB/100 Ft.	dB/100m

Series 6 • 18 AWG Solid .040" Bare Copper-covered Steel Conductor • Duobond® II + Aluminum Braid Shield (90% Coverage)

Gas-injected Foam Polyethylene Insulation • PVC Jacket (Available in Black or Neutral)

80°C	1530A	NEC: CATV CM CEC: CM	U-1000 [▲] 1000 [▲]	U-304.8 304.8	31.0 32.0	14.1 14.5	18 AWG (solid) .040" BCCS 28.0Ω/M' 91.9Ω/km	.180 4.57	Duobond II* + 90% Aluminum Braid 5.0Ω/M' 16.4Ω/km	.270 6.86	75	83%	16.2	53.1	See Chart on page 6.92		
------	--------------	----------------------------------	--	------------------	--------------	--------------	---	--------------	--	--------------	----	-----	------	------	------------------------	--	--

[▲]1000 ft. and U-1000 ft. put-ups also available in White Neutral.

Plenum • Foam FEP Insulation • Natural Flamarrest® Jacket

75°C	1530AP	NEC: CATVP CMP CEC: CMP FT6	1000	304.8	31.0	14.1	18 AWG (solid) .040" BCCS 28.0Ω/M' 91.9Ω/km	.170 4.32	Duobond II* + 90% Aluminum Braid 5.0Ω/M' 16.4Ω/km	.235 5.97	75	83%	16.3	53.5	Sweep tested 5 MHz to 1 GHz.		
															1	.3	1.0
															10	.7	2.3
															50	1.6	5.3
															100	2.2	7.2
															200	3.0	9.8
															400	4.6	15.1
															700	6.6	21.7
															900	7.7	25.3
															1000	8.2	26.9

Gas-injected Foam Polyethylene Insulation • Black PVC Jacket

80°C	1531AM	—	1000	304.8	45.0	20.4	18 AWG (solid) .040" BCCS 28.0Ω/M' 91.9Ω/km	.180 4.57	Duobond II* + 90% Aluminum Braid 5.0Ω/M' 16.4Ω/km	.270 6.86 x x .410 10.41	75	83%	16.2	53.1	See Chart on page 6.92		
------	---------------	---	------	-------	------	------	---	--------------	--	---	----	-----	------	------	------------------------	--	--

.051" (1.3mm) galvanized steel messenger.

Gas-injected Foam Polyethylene Insulation • Polyethylene Jacket (Black or Orange)

Burial 80°C	1532A	—	1000	304.8	27.0	12.3	18 AWG (solid) .040" BCCS 28.0Ω/M' 91.9Ω/km	.180 4.57	Duobond II* + 90% Aluminum Braid 5.0Ω/M' 16.4Ω/km	.270 6.86	75	83%	16.2	53.1	See Chart on page 6.92		
----------------	--------------	---	------	-------	------	------	---	--------------	--	--------------	----	-----	------	------	------------------------	--	--

CoreGuard®

BCCS = Bare Copper-covered Steel • DCR = DC Resistance • FEP = Fluorinated Ethylene Propylene

Contact the Belden Customer Service Department for a Comprehensive Connector Cross Reference. **1-800-BELDEN-1**.

*Duobond II = Bonded Duofoil® (100% coverage) + aluminum braid (67% coverage).

Broadband Coax

CATV Cables Series 6

Description	Part No.	UL NEC/ C(UL) CEC Type	Standard Lengths		Standard Unit Weight		Conductor (stranding) Diameter Nom. DCR	Nominal Core OD		Shielding Materials Nom. DCR	Nominal OD		Nom. Imp. (Ω)	Nom. Vel. of Prop.	Nominal Capacitance		Nominal Attenuation		
			Ft.	m	Lbs.	kg		Inch	mm		Inch	mm			pF/Ft.	pF/m	MHz	dB/100 Ft.	dB/100m

Series 6 • 18 AWG Solid .040" Bare Copper-covered Steel Conductor • Duobond® III + Aluminum Braid Shield (60% Coverage)

Gas-injected Foam Polyethylene Insulation • Black PVC Jacket

80°C	9118	NEC: CATV CM CEC: CM	U-1000 [▲] 1000	U-304.8 304.8	30.0 30.0	13.6 13.6	18 AWG (solid) .040" BCCS 28.0Ω/M' 91.9Ω/km	.180	4.57	Duobond III* + 60% Aluminum Braid 6.5Ω/M' 21.3Ω/km	.278 x	7.06 x	75	83%	16.2	53.1	See Chart on page 6.92		
------	-------------	----------------------------------	-----------------------------	------------------	--------------	--------------	---	------	------	--	-----------	-----------	----	-----	------	------	------------------------	--	--

▲U-1000 ft. put-up also available in Beige, White and White Neutral.

80°C	9119M	—	1000	304.8	43.0	19.5	18 AWG (solid) .040" BCCS 28.0Ω/M' 91.9Ω/km	.180	4.57	Duobond III* + 60% Aluminum Braid 6.5Ω/M' 21.3Ω/km	.275 x	6.99 x	75	83%	16.2	53.1	See Chart on page 6.92		
------	--------------	---	------	-------	------	------	---	------	------	--	-----------	-----------	----	-----	------	------	------------------------	--	--

.051" (1.3mm) galvanized steel messenger.

80°C	1546A	NEC: CATV CM CEC: CM	U-1000	U-304.8	31.0	14.1	18 AWG (solid) .040" BCCS 28.0Ω/M' 91.9Ω/km	.180	4.57	Duobond III* + 60% Aluminum Braid 6.5Ω/M' 21.3Ω/km	.278	7.06	75	83%	16.2	53.1	See Chart on page 6.92		
------	--------------	----------------------------------	--------	---------	------	------	---	------	------	--	------	------	----	-----	------	------	------------------------	--	--

CoreGuard®

Gas-injected Foam Polyethylene Insulation • Polyethylene Jacket (Black or Orange)

Burial 80°C	1837A	—	1000	304.8	26.0	11.8	18 AWG (solid) .040" BCCS 28.0Ω/M' 91.9Ω/km	.180	4.57	Duobond III* + 60% Aluminum Braid 6.5Ω/M' 21.3Ω/km	.275	6.99	75	83%	16.2	53.1	See Chart on page 6.92		
----------------	--------------	---	------	-------	------	------	---	------	------	--	------	------	----	-----	------	------	------------------------	--	--

CoreGuard®

Series 6 • 18 AWG Solid .040" Bare Copper-covered Steel Conductor • Bonded Beldfoil® + Aluminum Braid Shield (50% Coverage)

Gas-injected Foam Polyethylene Insulation • Black PVC Jacket

80°C	5339G5 <small>new</small>	NEC: CATV, CMG CEC: CMG FT4	U-1000 1000	U-304.8 304.8	24.0 24.0	10.9 10.9	18 AWG (solid) .040" BCCS 28.0Ω/M' 91.9Ω/km	.180	4.57	Bonded Beldfoil + 50% AL Braid 15.0Ω/M' 49.2Ω/km	.253	6.43	75	83%	16.2	53.1	See Chart on page 6.92		
------	-------------------------------------	---	----------------	------------------	--------------	--------------	---	------	------	--	------	------	----	-----	------	------	------------------------	--	--

AL = Aluminum • BCCS = Bare Copper-covered Steel • DCR = DC Resistance

Contact the Belden Customer Service Department for a Comprehensive Connector Cross Reference. **1-800-BELDEN-1**.

*Duobond III = Bonded Duofoil® (100% coverage) + aluminum braid (67% coverage) + Duofoil (100% coverage).

Broadband Coax

CATV Cables

Series 6

Description	Part No.	UL NEC/ C(UL) CEC Type	Standard Lengths		Standard Unit Weight		Conductor (stranding) Diameter Nom. DCR	Nominal Core OD		Shielding Materials Nom. DCR	Nominal OD		Nom. Imp. (Ω)	Nom. Vel. of Prop.	Nominal Capacitance		Nominal Attenuation		
			Ft.	m	Lbs.	kg		Inch	mm		Inch	mm			pF/Ft.	pF/m	MHz	dB/100 Ft.	dB/100m

Series 6 • 18 AWG Solid .040" Bare Copper-covered Steel Conductor(s) • Duobond® III + Aluminum Braid Shield (77% Coverage)

Gas-injected Foam Polyethylene Insulation • Black PVC Jacket

80°C	1613A	NEC: B-700 [▲] CATV U-1000 [▲] CM 1000 CEC: U-304.8 CM 304.8	B-213.0	19.6	8.9	18 AWG (solid) .040"	.180	4.57	Duobond III* + 77% Aluminum Braid	.278	7.06	75	83%	16.2	53.1	See Chart on page 6.92		
			U-304.8	31.0	14.1	28.0Ω/M' 91.9Ω/km			5.6Ω/M' 18.4Ω/km									

[▲]B-700 also available in White. U-1000 ft. also available in White and White Neutral.

80°C	1615AM	—	1000	304.8	44.0	20.0	18 AWG (solid) .040"	.180	4.57	Duobond III* + 77% Aluminum Braid	.275	6.99	75	83%	16.2	53.1	See Chart on page 6.92		
							28.0Ω/M' 91.9Ω/km			.416	10.57								

.051" (1.3mm) galvanized steel messenger. Sweep tested 5 MHz to 1 GHz.

80°C	1616AM	—	1000	304.8	45.0	20.4	18 AWG (solid) .040"	.180	4.57	Duobond III* + 77% Aluminum Braid	.275	6.99	75	83%	16.2	53.1	See Chart on page 6.92		
							28.0Ω/M' 91.9Ω/km			.416	10.57								

CoreGuard® .051" (1.3mm) galvanized steel messenger. Min. bend radius for minor axis only.

Gas-injected Foam Polyethylene Insulation • Polyethylene Jacket (Black or Orange)

Burial 80°C	1614A	—	1000	304.8	27.0	12.3	18 AWG (solid) .040"	.180	4.57	Duobond III* + 77% Aluminum Braid	.275	6.99	75	83%	16.2	53.1	See Chart on page 6.92		
							28.0Ω/M' 91.9Ω/km			5.6Ω/M' 18.4Ω/km									

CoreGuard®

BCCS = Bare Copper-covered Steel • DCR = DC Resistance

Contact the Belden Customer Service Department for a Comprehensive Connector Cross Reference. **1-800-BELDEN-1**.

*Duobond III = Bonded Duofoil® (100% coverage) + aluminum braid (67% coverage) + Duofoil (100% coverage).

Broadband Coax

CATV Cables Series 6

Description	Part No.	UL NEC/ C(UL) CEC Type	Standard Lengths		Standard Unit Weight		Conductor (stranding) Diameter Nom. DCR	Nominal Core OD		Shielding Materials Nom. DCR	Nominal OD		Nom. Imp. (Ω)	Nom. Vel. of Prop.	Nominal Capacitance		Nominal Attenuation		
			Ft.	m	Lbs.	kg		Inch	mm		Inch	mm			pF/Ft.	pF/m	MHz	dB/100 Ft.	dB/100m

Series 6 • 18 AWG Solid .040" Bare Copper-covered Steel Conductor(s) • Duobond Plus® + Aluminum Braid Shield (77% Coverage)

Gas-injected Foam Polyethylene Insulation • Black PVC Jacket

80°C	9058	NEC: CATV CM CEC: CM	U-1000*	U-304.8	32.0	14.5	18 AWG (solid) .040"	.180	4.57	Duobond Plus* + 77% Aluminum Braid	.275	6.99	75	83%	16.2	53.1	See Chart on page 6.92		
			1000	304.8	31.0	14.1	28.0Ω/M' 91.9Ω/km			5.6Ω/M' 18.4Ω/km							Sweep tested 5 MHz to 1 GHz.		



Shorting Fold
*U-1000 ft. put-up also available in White or Beige.

80°C	9059M <small>new</small>	—	1000	304.8	43.0	19.5	18 AWG (solid) .040"	.180	4.57	Duobond Plus* + 77% Aluminum Braid	.275	6.99	75	83%	16.2	53.1	See Chart on page 6.92			
							28.0Ω/M' 91.9Ω/km			.416	10.57							Sweep tested 5 MHz to 1 GHz.		

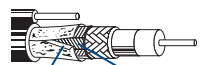

Shorting Fold CoreGuard®
.051" (1.3mm) galvanized steel messenger.

80°C	1260AM	—	1000	304.8	44.0	20.0	18 AWG (solid) .040"	.180	4.57	Duobond Plus* + 77% Aluminum Braid	.275	6.99	75	83%	16.2	53.1	See Chart on page 6.92			
							28.0Ω/M' 91.9Ω/km			.416	10.57							Sweep tested 5 MHz to 1 GHz.		



Shorting Fold CoreGuard
.051" (1.3mm) galvanized steel messenger.

Gas-injected Foam Polyethylene Insulation • PVC Jacket (Available in Black or Orange)

80°C	9062	—	1000	304.8	27.0	12.3	18 AWG (solid) .040"	.180	4.57	Duobond Plus* + 77% Aluminum Braid	.275	6.99	75	83%	16.2	53.1	See Chart on page 6.92		
							28.0Ω/M' 91.9Ω/km			5.6Ω/M' 18.4Ω/km							Sweep tested 5 MHz to 1 GHz.		



Shorting Fold CoreGuard

BCCS = Bare Copper-covered Steel • DCR = DC Resistance
Contact the Belden Customer Service Department for a Comprehensive Connector Cross Reference. **1-800-BELDEN-1**.
*Duobond Plus = Bonded Duofoil® (100% coverage) + aluminum braid (67% coverage) + shorting fold.

Broadband Coax

CATV Cables

Series 6

Description	Part No.	UL NEC/ C(UL) CEC Type	Standard Lengths		Standard Unit Weight		Conductor (stranding) Diameter Nom. DCR	Nominal Core OD		Shielding Materials Nom. DCR	Nominal OD		Nom. Imp. (Ω)	Nom. Vel. of Prop.	Nominal Capacitance		Nominal Attenuation		
			Ft.	m	Lbs.	kg		Inch	mm		Inch	mm			pF/Ft.	pF/m	MHz	dB/100 Ft.	dB/100m

Series 6 • 18 AWG Solid .040" Bare Copper-covered Steel Conductor • Duobond® IV Quad Shield (60% and 40% Coverage)

Gas-injected Foam Polyethylene Insulation • Black PVC Jacket

80°C	1191AM	—	1000	304.8	46.0	20.9	18 AWG (solid) .040" BCCS 28.0Ω/M' 91.9Ω/km	.180	4.57	Duobond IV* 60% & 40% Aluminum Braids 4.8Ω/M' 15.7Ω/km	.298 x .433	7.57 x 11.00	75	83%	16.2	53.1	See Chart on page 6.92		
------	---------------	---	------	-------	------	------	---	------	------	---	-------------------	--------------------	----	-----	------	------	------------------------	--	--

.051" (1.3mm) galvanized steel messenger.

80°C	1322R <small>NEW</small>	NEC: CATVR, CMR CEC: CMG FT4	U-1000 1000	U-304.8 304.8	41.0 35.0	18.6 15.9	18 AWG (solid) .040" BCCS 28.0Ω/M' 91.9Ω/km	.180	4.57	Duobond IV* 60% & 40% Aluminum Braids 4.8Ω/M' 15.7Ω/km	.298	7.57	75	83%	16.2	53.1	5 55 500 750 1000 1450 1800 3000	.5 1.4 4.1 5.1 6.0 7.4 8.3 10.5	1.6 4.6 13.5 16.7 19.7 24.3 27.2 34.5
------	------------------------------------	--	----------------	------------------	--------------	--------------	---	------	------	---	------	------	----	-----	------	------	---	--	--

Gas-injected Foam Polyethylene Insulation • PVC Jacket (Available in Black or White)

80°C	1189A	NEC: CATV, CM CEC: CM	U-500 U-1000 [▲]	U-152.4 U-304.8	18.0 35.0	8.2 15.9	18 AWG (solid) .040" BCCS 28.0Ω/M' 91.9Ω/km	.180	4.57	Duobond IV* 60% & 40% Aluminum Braids 4.8Ω/M' 15.7Ω/km	.298	7.57	75	83%	16.2	53.1	See Chart on page 6.92		
------	--------------	-----------------------------------	------------------------------	--------------------	--------------	-------------	---	------	------	---	------	------	----	-----	------	------	------------------------	--	--

[▲]1000 ft. put-up also available in Beige or White Neutral.

Plenum • Foam FEP Insulation • Natural Flamarrest® Jacket

75°C	1189AP	NEC: CATVP CMP CEC: CMP FT6	1000	304.8	32.0	14.5	18 AWG (solid) .040" BCCS 28.0Ω/M' 91.9Ω/km	.170	4.32	Duobond IV* 60% & 40% Aluminum Braids 4.8Ω/M' 15.7Ω/km	.248	6.30	75	83%	16.3	53.5	1 10 50 100 200 400 700 900 1000	.3 .7 1.6 2.2 3.0 4.6 6.6 7.7 8.2	1.0 2.2 5.3 7.2 9.8 15.1 21.7 25.3 26.9
------	---------------	---	------	-------	------	------	---	------	------	---	------	------	----	-----	------	------	--	---	---

BCCS = Bare Copper-covered Steel • DCR = DC Resistance • FEP = Fluorinated Ethylene Propylene

Contact the Belden Customer Service Department for a Comprehensive Connector Cross Reference. **1-800-BELDEN-1**.

*Duobond IV = Bonded Duofoil® (100% coverage) + aluminum braid (67% coverage) + Duofoil (100% coverage) + aluminum braid (46% coverage).

Broadband Coax

CATV Cables

Series 6

Description	Part No.	UL NEC/ C(UL) CEC Type	Standard Lengths		Standard Unit Weight		Conductor (stranding) Diameter Nom. DCR	Nominal Core OD		Shielding Materials Nom. DCR	Nominal OD		Nom. Imp. (Ω)	Nom. Vel. of Prop.	Nominal Capacitance		Nominal Attenuation		
			Ft.	m	Lbs.	kg		Inch	mm		Inch	mm			pF/Ft.	pF/m	MHz	dB/100 Ft.	dB/100m

Series 6 • 18 AWG Solid .040" Bare Copper-covered Steel Conductor • Duobond® IV Quad Shield (60% and 40% Coverage)

Gas-injected Foam Polyethylene Insulation • Polyethylene Jacket with CoreGuard® (Black or Orange)

Burial 80°C	1190A	—	1000	304.8	31.0	14.1	18 AWG (solid) .040" BCCS 28.0Ω/M' 91.9Ω/km	.180	4.57	Duobond IV* 60% + 40% Aluminum Braids 4.8Ω/M' 15.7Ω/km	.298	7.57	75	83%	16.2	53.1	See Chart on page 6.92		



CoreGuard®

Series 6 • 18 AWG Solid .040" Bare Copper-covered Steel Conductor • Duofoil® (100% Coverage) + TC Braid Shield (95% Coverage)

Plenum • Foam FEP Insulation • Black FEP Jacket

200°C	89120	NEC: CATVP CMP CEC: CMP FT6	500	152.4	21.5	9.8	18 AWG (solid) .040" BCCS 28.0Ω/M' 91.9Ω/km	.170	4.32	Duofoil 95% TC Braid 1.7Ω/M' 5.6Ω/km	.234	5.94	75	82%	16.5	54.1	1	.3	1.0
			1000	304.8	46.0	20.9											10	.7	2.2



Plenum • Foam FEP Insulation • Black Fluorocopolymer Jacket

150°C	87120	NEC: CATVP CMP CEC: CMP FT6, CXC FT4	500	152.4	20.5	9.3	18 AWG (solid) .040" BCCS 28.0Ω/M' 91.9Ω/km	.170	4.32	Duofoil 95% TC Braid 1.7Ω/M' 5.6Ω/km	.234	5.94	75	82%	16.5	54.1	1	.3	1.0
			1000	304.8	45.0	20.4											10	.7	2.2



Plenum • Foam FEP Insulation • Natural Flamarrest® Jacket

75°C	82120	NEC: CATVP CMP CEC: CMP FT6	1000	304.8	44.0	20.0	18 AWG (solid) .040" BCCS 28.0Ω/M' 91.9Ω/km	.170	4.32	Duofoil 95% TC Braid 1.7Ω/M' 5.6Ω/km	.234	5.94	75	82%	16.5	54.1	1	.3	1.0
																	10	.7	2.2



Series 6 • 18 AWG Solid .040" BCCS Conductor • Duofoil (100% Coverage) + TC Braid Shield (60% and 40% Coverage)

Plenum • Foam FEP Insulation • Snow Beige FEP Jacket

200°C	1152A	NEC: CMP CEC: CMP FT6	500	152.4	27.5	12.5	18 AWG (solid) .040" BCCS 28.0Ω/M' 91.9Ω/km	.170	4.32	(2) Duofoil Shields + (2) TC Braids 1.8Ω/M' 5.9Ω/km	.273	6.93	75	82%	16.5	54.1	1	.3	1.0
			1000	304.8	53.0	24.1											10	.7	2.2



BCCS = Bare Copper-covered Steel • DCR = DC Resistance • FEP = Fluorinated Ethylene Propylene • TC = Tinned Copper

Contact the Belden Customer Service Department for a Comprehensive Connector Cross Reference. **1-800-BELDEN-1**.

*Duobond IV = Bonded Duofoil (100% coverage) + aluminum braid (67% coverage) + Duofoil (100% coverage) + aluminum braid (46% coverage).

Broadband Coax

CATV Cables

Series 11

Description	Part No.	UL NEC/ C(UL) CEC Type	Standard Lengths		Standard Unit Weight		Conductor (stranding) Diameter Nom. DCR	Nominal Core OD		Shielding Materials Nom. DCR	Nominal OD		Nom. Imp. (Ω)	Nom. Vel. of Prop.	Nominal Capacitance		Nominal Attenuation		
			Ft.	m	Lbs.	kg		Inch	mm		Inch	mm			pF/Ft.	pF/m	MHz	dB/ 100 Ft.	dB/ 100m

Series 11 • 14 AWG Solid .064" BCCS Conductor • Duofoil® (100% Coverage) + Aluminum Braid Shield (40% Coverage)

Gas-injected Foam Polyethylene Insulation • Black PVC Jacket

80°C	9011	—	1000	304.8	66.0	29.9	14 AWG (solid) .064" BCCS 11.0Ω/M' 36.1Ω/km	.280	7.11	Duofoil + 40% Aluminum Braid 5.3Ω/M' 17.4Ω/km	.400	10.16	75	83%	16.2	53.1	See Chart on page 6.92		
------	-------------	---	------	-------	------	------	--	------	------	--	------	-------	----	-----	------	------	------------------------	--	--



Sweep tested 5 MHz to 1 GHz.

Series 11 • 14 AWG Solid .064" Bare Copper-covered Steel Conductor • Duobond® II + Aluminum Braid Shield (60% Coverage)

Gas-injected Foam Polyethylene Insulation • Black PVC Jacket

80°C	1523A	NEC: CATV CM CEC: CM	1000 [▲]	304.8	67.0	30.4	14 AWG (solid) .064" BCCS 11.0Ω/M' 36.1Ω/km	.280	7.11	Duobond II* + 60% Aluminum Braid 4.1Ω/M' 13.4Ω/km	.400	10.16	75	83%	16.2	53.1	See Chart on page 6.92		
------	--------------	----------------------------------	-------------------	-------	------	------	--	------	------	--	------	-------	----	-----	------	------	------------------------	--	--

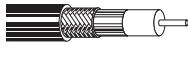

Sweep tested 5 MHz to 1 GHz.

[▲]1000 ft. put-up also available in White.

80°C	1523AN	—	1000	304.8	68.0	30.9	14 AWG (solid) .064" BCCS 11.0Ω/M' 36.1Ω/km	.280	7.11	Duobond II* + 60% Aluminum Braid 4.1Ω/M' 13.4Ω/km	.400	10.16	75	83%	16.2	53.1	See Chart on page 6.92		
------	---------------	---	------	-------	------	------	--	------	------	--	------	-------	----	-----	------	------	------------------------	--	--

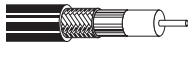

Sweep tested 5 MHz to 1 GHz.

80°C	1523R	NEC: CATVR CMR CEC: CMR	500 1000	152.4 304.8	35.0 70.0	15.9 31.8	14 AWG (solid) .064" BCCS 11.0Ω/M' 36.1Ω/km	.280	7.11	Duobond II* + 60% Aluminum Braid 4.1Ω/M' 13.4Ω/km	.400	10.16	75	83%	16.2	53.1	See Chart on page 6.92		
------	--------------	-------------------------------------	-------------	----------------	--------------	--------------	--	------	------	--	------	-------	----	-----	------	------	------------------------	--	--



Sweep tested 5 MHz to 1 GHz.

Aerial 80°C	1524AM	—	1000	304.8	90.0	40.8	14 AWG (solid) .064" BCCS 11.0Ω/M' 36.1Ω/km	.280	7.11	Duobond II* + 60% Aluminum Braid 4.1Ω/M' 13.4Ω/km	.400 x .580	10.16 x 14.73	75	83%	16.2	53.1	See Chart on page 6.92		
-----------------------	---------------	---	------	-------	------	------	--	------	------	--	-------------------	---------------------	----	-----	------	------	------------------------	--	--

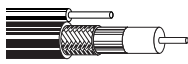

Sweep tested 5 MHz to 1 GHz.

.072" (1.83mm) galvanized steel messenger.

Gas-injected Foam Polyethylene Insulation • Polyethylene Jacket (Available in Black or Orange)

Burial 80°C	1525A	—	1000	304.8	60.0	27.3	14 AWG (solid) .064" BCCS 11.0Ω/M' 36.1Ω/km	.280	7.11	Duobond II* + 60% Aluminum Braid 4.1Ω/M' 13.4Ω/km	.400	10.16	75	83%	16.2	53.1	See Chart on page 6.92		
-----------------------	--------------	---	------	-------	------	------	--	------	------	--	------	-------	----	-----	------	------	------------------------	--	--



CoreGuard®

Sweep tested 5 MHz to 1 GHz.

Plenum • Foam FEP Insulation • Black Fluorocopolymer Jacket

150°C	1523AP	NEC: CATVP CMP CEC: CMP	1000	304.8	62.0	28.2	14 AWG (solid) .064" BCCS 11.0Ω/M' 36.1Ω/km	.274	6.96	Duobond II* + 60% Aluminum Braid 4.1Ω/M' 13.4Ω/km	.348	8.84	75	83%	16.3	53.5	1	2	.6
-------	---------------	-------------------------------------	------	-------	------	------	--	------	------	--	------	------	----	-----	------	------	---	---	----

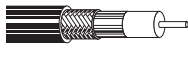

Sweep tested 5 MHz to 1 GHz.

BCCS = Bare Copper-covered Steel • DCR = DC Resistance • FEP = Fluorinated Ethylene Propylene

Contact the Belden Customer Service Department for a Comprehensive Connector Cross Reference. **1-800-BELDEN-1**.

*Duobond II = Bonded Duofoil® (100% coverage) + aluminum braid (67% coverage).

Broadband Coax

CATV Cables Series 11

Description	Part No.	UL NEC/ C(UL) CEC Type	Standard Lengths		Standard Unit Weight		Conductor (stranding) Diameter Nom. DCR	Nominal Core OD		Shielding Materials Nom. DCR	Nominal OD		Nom. Imp. (Ω)	Nom. Vel. of Prop.	Nominal Capacitance		Nominal Attenuation		
			Ft.	m	Lbs.	kg		Inch	mm		Inch	mm			pF/Ft.	pF/m	MHz	dB/100 Ft.	dB/100m

Series 11 • 14 AWG Solid .064" Bare Copper-covered Steel Conductor • Duobond Plus® + Aluminum Braid Shield (77% Coverage)

Gas-injected Foam Polyethylene Insulation • Black PVC Jacket

80°C	9064	NEC: CATV CM CEC: CM	1000	304.8	68.0	30.9	14 AWG (solid) .064" BCCS 11.0Ω/M' 36.1Ω/km	.280	7.11	Duobond Plus* + 77% Aluminum Braid 3.8Ω/M' 12.5Ω/km	.400	10.16	75	83%	16.2	53.1	See Chart on page 6.92		
------	-------------	-------------------------------	------	-------	------	------	---	------	------	---	------	-------	----	-----	------	------	------------------------	--	--



Shorting Fold

Sweep tested 5 MHz to 1 GHz.

Aerial 80°C

80°C	9065M	—	1000	304.8	86.0	39.0	14 AWG (solid) .064" BCCS 11.0Ω/M' 36.1Ω/km	.280	7.11	Duobond Plus* + 77% Aluminum Braid 3.8Ω/M' 12.5Ω/km	.400	10.16	75	83%	16.2	53.1	See Chart on page 6.92		
------	--------------	---	------	-------	------	------	---	------	------	---	------	-------	----	-----	------	------	------------------------	--	--

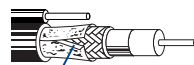

Shorting Fold

Sweep tested 5 MHz to 1 GHz.

.072" (1.8mm) galvanized steel messenger.

Gas-injected Foam Polyethylene Insulation • Polyethylene Jacket (Black or Orange)

Burial 80°C	9764	—	1000	304.8	60.0	27.2	14 AWG (solid) .064" BCCS 11.0Ω/M' 36.1Ω/km	.280	7.11	Duobond Plus* + 77% Aluminum Braid 3.8Ω/M' 12.5Ω/km	.400	10.16	75	83%	16.2	53.1	See Chart on page 6.92		
-------------	-------------	---	------	-------	------	------	---	------	------	---	------	-------	----	-----	------	------	------------------------	--	--



Shorting Fold

Sweep tested 5 MHz to 1 GHz.

Series 11 • 14 AWG Solid .064" Bare Copper-covered Steel Conductor • Duobond® III + Aluminum Braid Shield (77% Coverage)

Gas-injected Foam Polyethylene Insulation • Black PVC Jacket

Aerial 80°C	7983A <small>new</small>	—	1000	304.8	89.0	40.4	14 AWG (solid) .064" BCCS 11.0Ω/M' 36.1Ω/km	.280	7.11	Duobond III* + 77% Aluminum Braid 4.0Ω/M' 13.1Ω/km	.400	10.16	75	83%	16.2	53.1	See Chart on page 6.92		
-------------	------------------------------------	---	------	-------	------	------	---	------	------	--	------	-------	----	-----	------	------	------------------------	--	--



CoreGuard®

.072" (1.8mm) galvanized steel messenger.

Gas-injected Foam Polyethylene Insulation • Polyethylene Jacket (Black or Orange)

Burial 80°C	7984A <small>new</small>	—	1000	304.8	57.0	25.9	14 AWG (solid) .064" BCCS 11.0Ω/M' 36.1Ω/km	.280	7.11	Duobond III* + 77% Aluminum Braid 4.0Ω/M' 13.1Ω/km	.400	10.16	75	83%	16.2	53.1	See Chart on page 6.92		
-------------	------------------------------------	---	------	-------	------	------	---	------	------	--	------	-------	----	-----	------	------	------------------------	--	--



CoreGuard

Sweep tested 5 MHz to 1 GHz.

BCCS = Bare Copper-covered Steel • DCR = DC Resistance

Contact the Belden Customer Service Department for a Comprehensive Connector Cross Reference. **1-800-BELDEN-1**.

*Duobond Plus = Bonded Duofoil® (100% coverage) + aluminum braid (67% coverage) + shorting fold.
Duobond III = Bonded Duofoil (100% coverage) + aluminum braid (67% coverage) + Duofoil (100% coverage).

Broadband Coax

CATV Cables

Series 11

Description	Part No.	UL NEC/ C(UL) CEC Type	Standard Lengths		Standard Unit Weight		Conductor (stranding) Diameter Nom. DCR	Nominal Core OD		Shielding Materials Nom. DCR	Nominal OD		Nom. Imp. (Ω)	Nom. Vel. of Prop.	Nominal Capacitance		Nominal Attenuation		
			Ft.	m	Lbs.	kg		Inch	mm		Inch	mm			pF/Ft.	pF/m	MHz	dB/100 Ft.	dB/100m

Series 11 • 14 AWG Solid .064" Bare Copper-covered Steel Conductor • Duobond® IV Quad Shield (60% and 40% Coverage)

Gas-injected Foam Polyethylene Insulation • Black PVC Jacket

80°C	1617A	NEC: CATV CEC: CM	1000	304.8	67.0	30.5	14 AWG (solid) .064" BCCS 11.0Ω/M' 36.1Ω/km	.280	7.11	Duobond IV* 60% & 40% Aluminum Braids 3.0Ω/M' 9.8Ω/km	.407	10.34	75	83%	16.2	53.1	See Chart on page 6.92		
------	--------------	----------------------	------	-------	------	------	---	------	------	--	------	-------	----	-----	------	------	------------------------	--	--



Sweep tested 5 MHz to 1 GHz.

80°C	1619AM	—	1000	304.8	84.0	38.2	14 AWG (solid) .064" BCCS 11.0Ω/M' 36.1Ω/km	.280	7.11	Duobond IV* 60% & 40% Aluminum Braids 3.0Ω/M' 9.8Ω/km	.407 x .560	10.34 x 14.22	75	83%	16.2	53.1	See Chart on page 6.92		
------	---------------	---	------	-------	------	------	---	------	------	--	-------------------	---------------------	----	-----	------	------	------------------------	--	--

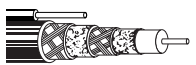

.072" (1.8mm) galvanized steel messenger.

Sweep tested 5 MHz to 1 GHz.

80°C	1620AM	—	1000	304.8	87.0	39.5	14 AWG (solid) .064" BCCS 11.0Ω/M' 36.1Ω/km	.280	7.11	Duobond IV* 60% & 40% Aluminum Braids 3.0Ω/M' 9.8Ω/km	.407 x .560	10.34 x 14.22	75	83%	16.2	53.1	See Chart on page 6.92		
------	---------------	---	------	-------	------	------	---	------	------	--	-------------------	---------------------	----	-----	------	------	------------------------	--	--



CoreGuard®

.072" (1.8mm) galvanized steel messenger.

Sweep tested 5 MHz to 1 GHz.

Gas-injected Foam Polyethylene Insulation • Polyethylene Jacket (Black or Orange)

Burial 80°C	1618A	—	1000	304.8	61.0	27.7	14 AWG (solid) .064" BCCS 11.0Ω/M' 36.1Ω/km	.280	7.11	Duobond IV* 60% & 40% Aluminum Braids 3.0Ω/M' 9.8Ω/km	.407	10.34	75	83%	16.2	53.1	See Chart on page 6.92		
----------------	--------------	---	------	-------	------	------	---	------	------	--	------	-------	----	-----	------	------	------------------------	--	--

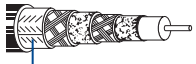

CoreGuard®

Sweep tested 5 MHz to 1 GHz.

Series 11 • 14 AWG Solid .064" BCCS Conductors • Duofoil® (100% Coverage) + TC Braid Shields (60% and 40% Coverage)

Plenum • Foam FEP Teflon Insulation • Snow Beige FEP Jacket

200°C	1153A	NEC: CMP CL2P CEC: CMP FT6	500 1000	152.4 304.8	52.5 106.0	23.9 48.2	14 AWG (solid) .064" BCCS 11.0Ω/M' 36.1Ω/km	.280	7.11	(2) Duofoil Shields + (2) TC BCCS 1.8Ω/M' 5.9Ω/km	.387	9.83	75	82%	16.2	53.1	1 10 50 100 200 400 700 900 1000	.2 .4 1.2 1.7 2.5 3.5 4.6 5.3 5.6	.7 1.3 3.9 5.6 8.2 11.5 15.1 17.4 18.4
-------	--------------	-------------------------------	-------------	----------------	---------------	--------------	---	------	------	---	------	------	----	-----	------	------	--	---	--



Sweep tested 5 MHz to 400 MHz.

BCCS = Bare Copper-covered Steel • DCR = DC Resistance • FEP = Fluorinated Ethylene Propylene • TC = Tinned Copper

Contact the Belden Customer Service Department for a Comprehensive Connector Cross Reference. **1-800-BELDEN-1**.

* Duobond IV = Bonded Duofoil (100% coverage) + aluminum braid (67% coverage) + Duofoil (100% coverage) + aluminum braid (46% coverage).

Teflon is a DuPont trademark.



For more information, contact **Belden Technical Support: 1-800-BELDEN-1 • www.belden.com**

Broadband Coax

Headend/Video Cables

Description	Part No.	UL NEC/ C(UL) CEC Type	Standard Lengths		Standard Unit Weight		Conductor (stranding) Diameter Nom. DCR	Nominal Core OD		Shielding Materials Nom. DCR	Nominal OD		Nom. Imp. (Ω)	Nom. Vel. of Prop.	Nominal Capacitance		Nominal Attenuation		
			Ft.	m	Lbs.	kg		Inch	mm		Inch	mm			pF/Ft.	pF/m	MHz	dB/100 Ft.	dB/100m

RG-59/U Type • 20 AWG Solid .032" SPCCS Conductor • Duobond Plus® + Aluminum Braid Shield (95% Coverage)

Gas-injected Foam Polyethylene Insulation • PVC Jacket (Available in 13 colors)*

80°C	9167	NEC: CATVR CMR CEC: CMG FT4	1000	304.8	27.0	12.3	20 AWG (solid) .032" SPCCS 25.8Ω/M' 84.6Ω/km	.144	3.66	Duobond Plus* + 95% Aluminum Braid 4.5Ω/M' 14.8Ω/km	.242	6.15	75	83%	16.2	53.1	See Chart on page 6.92		
------	-------------	---	------	-------	------	------	--	------	------	---	------	------	----	-----	------	------	------------------------	--	--

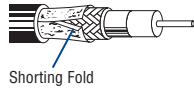

*Available in Black, Gray, White, Red, Blue, Yellow, Brown, Orange, Green, Purple, Beige, Pink or Aqua.

RG-59/U Type • 20 AWG Solid .032" Bare Copper • Duofoil® (100% Coverage) + Tinned Copper Braid Shield (95% Coverage)

Gas-injected Foam HDPE Insulation • PVC Jacket (Available in 10 colors)**

SDI/HDTV Digital Video 75°C	1505A	NEC: CMR CEC: CMG FT4	500 [▲] 1000 5000 [•]	152.4 304.8 1524.0	15.5 35.0 165.0	7.0 16.4 74.8	20 AWG (solid) .032" BC 10.0Ω/M' 32.8Ω/km	.145	3.68	Duofoil + 95% TC Braid 3.8Ω/M' 12.5Ω/km	.233	5.92	75	83%	16.3	53.5	1 3.6 5 7 10 67.5 71.5 88.5 100 135 143 180 270 360 540 720 750 1000 1500 2000 2250 3000	.3 .6 .6 .7 .9 2.1 2.1 2.2 2.3 2.7 2.8 3.1 3.8 4.4 5.5 6.4 6.5 7.6 7.6 8.9 9.2 10.2 12.5 14.4 18.0 21.0 21.3 24.9 30.5 30.5 38.0 44.0	1.0 1.8 2.1 2.4 2.9 6.7 6.9 7.2 7.6 8.9 9.2 10.2 12.5 14.4 18.0 21.0 21.3 24.9 30.5 30.5 38.0 44.0	For Plenum version of 1505A, see 1506A. Also available in bundled versions. See 7794A through 7798A.		
-----------------------------------	--------------	--------------------------------	---	--------------------------	-----------------------	---------------------	---	------	------	---	------	------	----	-----	------	------	---	--	---	---	--	--

▲500 ft. put-up available in Black, Red or Blue only.

•5000 ft. put-up may vary -0% to 10%.

**1000 ft. and 5000 ft. put-ups available in all ten colors: Black, Brown, Red, Orange, Yellow, Green, Blue, Purple, Gray or White.

RG-59/U Type • 22 AWG Stranded (7x29) .031" Bare Compacted Copper Conductor[†] • TC/BC Double Braid Shield (95% Coverage)

Gas-injected Foam HDPE Insulation • PVC Jacket (Matte Black, Red, Green, Blue, Yellow, White, Purple or Orange)

High-Flex SDI/HDTV Video Patch 75°C	1505F	NEC: CM CEC: CM	1000	304.8	45.0	20.4	22 AWG (7x29) .031" BCC 12.2Ω/M' 40.0Ω/km	.145	3.68	TC Double Braid 94% Shield Coverage 2.4Ω/M' 7.8Ω/km	.242	6.15	75	80%	17.0	55.7	1 3.6 5 7 10 67.5 71.5 88.5 100 135 143 180 270 360 540 720 750 1000 1500 2000 2250 3000	.2 .5 .6 .7 .9 2.4 2.4 2.5 2.8 3.0 3.5 3.6 4.1 5.1 6.0 7.4 8.7 8.9 10.5 13.3 15.7 16.9 20.3	.7 1.6 2.0 2.4 2.9 7.9 8.2 9.2 9.8 11.5 11.8 13.5 16.7 19.7 24.3 28.5 29.2 34.4 43.6 51.5 55.4 66.6			
--	--------------	--------------------------	------	-------	------	------	---	------	------	--	------	------	----	-----	------	------	---	---	--	--	--	--

[†]Compacted conductor combines impedance uniformity of solid conductors and "nick-resistance" of stranded conductor.

BC = Bare Copper • BCC = Bare Compacted Copper • DCR = DC Resistance • HDPE = High-density Polyethylene • SPCCS = Silver-plated, Copper-covered Steel • TC = Tinned Copper

Contact the Belden Customer Service Department for a Comprehensive Connector Cross Reference. **1-800-BELDEN-1**. Request quotations of RG/U cables not listed.

*Duobond Plus = Bonded Duofoil (100% coverage) + aluminum braid (67% coverage) + shorting fold.

Broadband Coax

Headend/Video Cables

Description	Part No.	UL NEC/ C(UL) CEC Type	Standard Lengths		Standard Unit Weight		Conductor (stranding) Diameter Nom. DCR	Nominal Core OD		Shielding Materials Nom. DCR	Nominal OD		Nom. Imp. (Ω)	Nom. Vel. of Prop.	Nominal Capacitance		Nominal Attenuation		
			Ft.	m	Lbs.	kg		Inch	mm		Inch	mm			pF/Ft.	pF/m	MHz	dB/100 Ft.	dB/100m

RG-59/U Type • 20 AWG Solid .031" Bare Copper Conductor • Tinned Copper/Bare Copper Double Braid Shield (98% Coverage)

Polyethylene Insulation • Polyethylene Jacket (Available in Red, Yellow, Green, Light Blue, White, Orange or Black)

80°C	8281	—	500 [*]	152.4	37.5	17.0	20 AWG (solid)	.198	5.03	TC Double Braid	.305	7.75	75	66%	21.0	68.9	1	.3	1.0
			1000	304.8	74.0	33.6	.031"			98% Shield Coverage							3.6	.5	1.6
							BC										10.0	.8	2.6
							9.9Ω/M'										71.5	2.1	6.9
							32.5Ω/km										135	3.0	9.8
																	270	4.3	14.1
																	360	5.1	16.7
																	540	6.3	20.7
																	720	7.4	24.3
																	750	7.6	24.9
																	1000	9.2	30.2

*500 ft. put-up not available in White.
Max operating voltage — Non UL 2900V RMS

Flame-retardant Semi-foam Polyethylene Insulation • PVC Jacket (Available in 9 colors)*

UL AWM Style 1354 (30V 80°C)	8281B	NEC: CMR CEC: CMG FT4	1000	304.8	84.0	38.1	20 AWG (solid)	.198	5.03	TC Double Braid	.305	7.75	75	66%	21.0	68.9	1	.3	1.0
							.031"			98% Shield Coverage							3.6	.5	1.6
							BC										10.0	.8	2.6
							9.9Ω/M'										71.5	2.1	6.9
							32.5Ω/km										135	3.0	9.8
																	270	4.4	14.4
																	360	5.1	16.7
																	540	6.6	21.7
																	720	7.8	25.6
																	750	8.0	26.2
																	1000	10.2	33.5

*8281B available in Red, Orange, Yellow, Green, Blue, Purple, Gray, White or Black.

22 AWG Stranded (7x29) .031" Bare Compacted Copper Conductor* • Tinned Copper/Bare Copper Double Braid Shield (98% Coverage)

Polyethylene Insulation • PVC Jacket (Matte Red, Blue, Green, Gray or Black)

High-Flex 60°C	8281F	—	500 [*]	152.4	34.5	15.7	22 AWG (7x29)	.198	5.03	TC Double Braid	.305	7.75	75	66%	21.0	68.9	1	.3	.9
			1000	304.8	67.0	30.4	.031"			98% Shield Coverage							3.6	.5	1.7
							BCC										10.0	.9	3.0
							12.2Ω/M'										71.5	2.5	8.2
							40.0Ω/km										135	3.6	11.8
																	270	5.1	16.7
																	360	6.0	19.7
																	540	7.4	24.3
																	720	8.7	28.5
																	750	8.9	29.2
																	1000	10.5	34.5

*500 ft. put-up available in Black only.
Max operating voltage — Non UL 2900V RMS
*Compacted conductor combines impedance uniformity of solid conductors and "nick-resistance" of stranded conductor.

BC = Bare Copper • BCC = Bare Compacted Copper • DCR = DC Resistance • SPC = Silver-plated Copper • SPCCS = Silver-plated, Copper-covered Steel • TC = Tinned Copper
Contact the Belden Customer Service Department for a Comprehensive Connector Cross Reference. **1-800-BELDEN-1**. Request quotations of RG/U cables not listed.

DBS Cable

Series 6

Description	Part No.	UL NEC/ C(UL) CEC Type	Standard Lengths		Standard Unit Weight		Conductor (stranding) Diameter Nom. DCR	Nominal Core OD		Shielding Materials Nom. DCR	Nominal OD		Nom. Imp. (Ω)	Nom. Vel. of Prop.	Nominal Capacitance		Nominal Attenuation		
			Ft.	m	Lbs.	kg		Inch	mm		Inch	mm			pF/Ft.	pF/m	MHz	dB/100 Ft.	dB/100m

Series 6 • 18 AWG Solid .040" Bare Copper or Bare Copper-covered Steel Conductor (see below) • Duobond® II + Aluminum Braid Shield (60% Coverage)

Gas-injected Foam Polyethylene Insulation • PVC Jacket (Black, Gray, White or Neutral)

80°C 	1829A	NEC:	U-1000†	U-304.8	29.0	13.2	18 AWG (solid) .040" BCCS 28.0Ω/M' 91.9Ω/km	.180	4.57	Duobond II* + 60% Aluminum Braid 9.0Ω/M' 29.5Ω/km	.270	6.86	75	83%	16.2	53.1	5	.5	1.6
		CATV CM	1000†	304.8	29.0	13.2											55	1.4	4.6
		CEC:															211	2.6	8.5
		CM															500	4.1	13.5
																	750	5.1	16.7
																	862	5.5	18.0
																	1000	6.0	19.7
																	1450	7.8	25.6
																	1800	8.6	28.2
																	2250	9.8	32.2

†Final put-up length may vary ±10% for spools, ±5% for unreel cartons.

80°C 	1829AC	NEC:	U-1000 [▲]	U-304.8	27.0	12.3	18 AWG (solid) .040" BCAC 6.4Ω/M' 21.0Ω/km	.180	4.57	Duobond II* + 60% Aluminum Braid 9.0Ω/M' 29.5Ω/km	.270	6.86	75	83%	16.2	53.1	5	.5	1.6
		CATV CM	1000 [▲]	304.8	27.0	12.3											55	1.4	4.6
		CEC:															211	2.6	8.5
		CM															500	4.1	13.5
																	750	5.1	16.7
																	862	5.5	18.0
																	1000	6.0	19.7
																	1450	7.8	25.6
																	1800	8.6	28.2
																	2250	9.8	32.2

[▲]U-1000 ft. put-up available in Black, White or Gray only. 1000 ft. available in White or Black only.

80°C 	1829R <small>new</small>	NEC:	U-1000*	U-304.8	29.0	13.2	18 AWG (solid) .040" BCCS 28.0Ω/M' 21.0Ω/km	.180	4.57	Duobond II* + 60% Aluminum Braid 9.0Ω/M' 29.5Ω/km	.270	6.86	75	83%	16.2	53.1	5	.5	1.6
		CATVR, CMR															55	1.4	4.6
		CEC:															211	2.6	8.5
		CMG FT4															500	4.1	13.5
																	750	5.1	16.7
																	862	5.5	18.0
																	1000	6.0	19.7
																	1450	7.8	25.6
																	1800	8.6	28.2
																	2250	9.8	32.2

*U-1000 ft. put-up not available in Neutral.

Gas-injected Foam Polyethylene Insulation • Black Polyethylene Jacket

Burial 80°C 	1829B	—	1000	304.8	26.0	11.8	18 AWG (solid) .040" BCCS 28.0Ω/M' 91.9Ω/km	.180	4.57	Duobond II* + 60% Aluminum Braid 9.0Ω/M' 29.5Ω/km	.270	6.86	75	83%	16.2	53.1	5	.5	1.6
																	55	1.4	4.6
																	211	2.6	8.5
																	500	4.1	13.5
																	750	5.1	16.7
																	862	5.5	18.0
																	1000	6.0	19.7
																	1450	7.8	25.6
																	1800	8.6	28.2
																	2250	9.8	32.2

CoreGuard®

Burial 80°C 	1829BC	—	1000	304.8	27.0	12.3	18 AWG (solid) .040" BCAC 6.4Ω/M' 21.0Ω/km	.180	4.57	Duobond II* + 60% Aluminum Braid 9.0Ω/M' 29.5Ω/km	.270	6.86	75	83%	16.2	53.1	5	.5	1.6
																	55	1.4	4.6
																	211	2.6	8.5
																	500	4.1	13.5
																	750	5.1	16.7
																	862	5.5	18.0
																	1000	6.0	19.7
																	1450	7.8	25.6
																	1800	8.6	28.2
																	2250	9.8	32.2

CoreGuard®

Plenum • Foam FEP Insulation • Natural Flamarrest® Jacket

75°C 	1829P <small>new</small>	NEC:	U-1000	U-304.8	27.0	12.3	18 AWG (solid) .040" BCCS 28.0Ω/M' 91.9Ω/km	.170	4.32	Duobond II* + 60% Aluminum Braid 9.0Ω/M' 29.5Ω/km	.235	5.97	75	83%	16.3	53.4	1	.3	1.0
		CATVP, CMP	1000	304.8	27.0	12.3											10	.7	2.2
		CEC:															50	1.5	4.9
		CMP FT6															100	2.1	6.9
																	200	3.0	9.8
																	400	4.4	14.4
																	700	6.1	20.0
																	900	7.2	23.6
																	1000	7.6	24.9
																	1450	9.6	31.5

BC = Bare Copper • BCAC = Bare Copper Anti-corrosion • BCCS = Bare Copper-covered Steel • DCR = DC Resistance • FEP = Fluorinated Ethylene Propylene

*Duobond II = Bonded Duofoil® (100% coverage) + aluminum braid (67% coverage).

DBS Cable

Series 6

Description	Part No.	UL NEC/ C(UL) CEC Type	Standard Lengths		Standard Unit Weight		Conductor (stranding) Diameter Nom. DCR	Nominal Core OD		Shielding Materials Nom. DCR	Nominal OD		Nom. Imp. (Ω)	Nom. Vel. of Prop.	Nominal Capacitance		Nominal Attenuation		
			Ft.	m	Lbs.	kg		Inch	mm		Inch	mm			pF/Ft.	pF/m	MHz	dB/100 Ft.	dB/100m

Series 6 • 18 AWG Solid .040" Bare Copper or Bare Copper-covered Steel Conductor (see below) • Duobond® II + AL Braid Shield (60% Coverage) (cont'd)

Gas-injected Foam Polyethylene Insulation • Black PVC Jacket

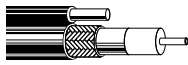
80°C 	1839A	—	1000	304.8	40.0	18.1	18 AWG (solid) .040"	.180	4.57	Duobond II* + 60% Aluminum Braid	.270 x .405	6.86 x 10.29	75	83%	16.2	53.1	5	.5	1.6
																	55	1.4	4.6
																	211	2.6	8.5
																	500	4.1	13.5
																	750	5.1	16.7
																	862	5.5	18.0
																	1000	6.0	19.7
																	1450	7.8	25.6
																	1800	8.6	28.2
																	2250	9.8	32.2

.045" (1.14mm) copper-covered steel, static ground.

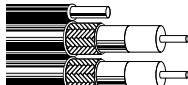
80°C 	1840A	—	500	152.4	37.5	17.0	18 AWG (solid) .040"	.180	4.57	Duobond II* + 60% Aluminum Braid	.273 x .703	6.93 x 17.86	75	83%	16.2	53.1	5	.5	1.6
																	55	1.4	4.6
																	211	2.6	8.5
																	500	4.1	13.5
																	750	5.1	16.7
																	862	5.5	18.0
																	1000	6.0	19.7
																	1450	7.8	25.6
																	1800	8.6	28.2
																	2250	9.8	32.2

.045" (1.14mm) copper-covered steel static ground.

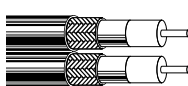
80°C 	1841A	NEC: CATV CM CEC: CM	1000	304.8	66.0	30.0	18 AWG (solid) .040"	.180	4.57	Duobond II* + 60% Aluminum Braid	.273 x .595	6.93 x 15.11	75	83%	16.2	53.1	5	.5	1.6
																	55	1.4	4.6
																	211	2.6	8.5
																	500	4.1	13.5
																	750	5.1	16.7
																	862	5.5	18.0
																	1000	6.0	19.7
																	1450	7.8	25.6
																	1800	8.6	28.2
																	2250	9.8	32.2

Gas-injected Foam Polyethylene Insulation • PVC Jacket (Black, Gray or White)

80°C 	1839AC	—	1000 [▲]	304.8	44.0	20.0	18 AWG (solid) .040"	.180	4.57	Duobond II* + 60% Aluminum Braid	.270 x .405	6.86 x 10.29	75	83%	16.2	53.1	5	.5	1.6
																	55	1.4	4.6
																	211	2.6	8.5
																	500	4.1	13.5
																	750	5.1	16.7
																	862	5.5	18.0
																	1000	6.0	19.7
																	1450	7.8	25.6
																	1800	8.6	28.2
																	2250	9.8	32.2
3000	11.3	37.1																	

[▲]1000 ft. put-up not available in White.
.045" (1.14mm) copper-covered steel static ground.

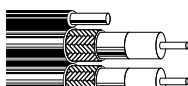
80°C 	1840AC	—	500	152.4	38.0	17.2	18 AWG (solid) .040"	.180	4.57	Duobond II* + 60% Aluminum BC	.273 x .703	6.93 x 17.86	75	83%	16.2	53.1	5	.5	1.6
																	55	1.4	4.6
																	211	2.6	8.5
																	500	4.1	13.5
																	750	5.1	16.7
																	862	5.5	18.0
																	1000	6.0	19.7
																	1450	7.8	25.6
																	1800	8.6	28.2
																	2250	9.8	32.2
3000	11.3	37.1																	

.045" (1.14mm) copper-covered steel static ground.

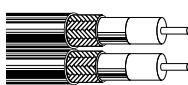
80°C 	1841AC	NEC: CATV CM CEC: CM	500	152.4	32.5	14.7	18 AWG (solid) .040"	.180	4.57	Duobond II* + 60% Aluminum Braid	.273 x .595	6.93 x 15.11	75	83%	16.2	53.1	5	.5	1.6
																	55	1.4	4.6
																	211	2.6	8.5
																	500	4.1	13.5
																	750	5.1	16.7
																	862	5.5	18.0
																	1000	6.0	19.7
																	1450	7.8	25.6
																	1800	8.6	28.2
																	2250	9.8	32.2
3000	11.3	37.1																	

AL = Aluminum • BC = Bare Copper • BCAC = Bare Copper Anti-corrosion • BCCS = Bare Copper-covered Steel • DCR = DC Resistance

*Duobond II = Bonded Duofoil® (100% coverage) + aluminum braid (67% coverage).

DBS Cable

Series 6

Description	Part No.	UL NEC/ C(UL) CEC Type	Standard Lengths		Standard Unit Weight		Conductor (stranding) Diameter Nom. DCR	Nominal Core OD		Shielding Materials Nom. DCR	Nominal OD		Nom. Imp. (Ω)	Nom. Vel. of Prop.	Nominal Capacitance		Nominal Attenuation		
			Ft.	m	Lbs.	kg		Inch	mm		Inch	mm			pF/Ft.	pF/m	MHz	dB/100 Ft.	dB/100m

Series 6 • 18 AWG Solid .040" Bare Copper-covered Steel Conductor • Duobond® II + Aluminum Braid Shield (60% Coverage)

Gas-injected Foam Polyethylene Insulation • Black Polyethylene Jacket

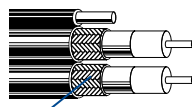
 <p>CoreGuard®</p>	Burial 80°C	1843A	—	1000	304.8	64.0	29.1	18 AWG (solid) .040"	.180	4.57	Duobond II* + 60% Aluminum Braid	.273 X .750	6.93 X 19.05	75	83%	16.2	53.1	5	.5	1.6
																		55	1.4	4.6
																		211	2.6	8.5
																		500	4.1	13.5
																		750	5.1	16.7
																		862	5.5	18.0
																		1000	6.0	19.7
																		1450	7.8	25.6
																		1800	8.6	28.2
																		2250	9.8	32.2

.045" (1.14mm) copper-covered steel static ground.
Suitable for Outdoor and Direct Burial applications.

HDTV Series 6 • 18 AWG Solid .040" Bare Copper Conductor • Duobond + Aluminum Braid Shields (77% and 80% Coverage)

Gas-injected Foam Polyethylene Insulation • PVC Jacket (Black or White)

 <p>Shorting Fold</p>	80°C	7915A	NEC: CATV CM	U-500	U-152.4	16.5	7.5	18 AWG (solid) .040"	.180	4.57	Duobond Plus** 77% & 80%	.275	6.99	75	83%	16.2	53.1	5	.5	1.6
																		55	1.4	4.6
																		211	2.6	8.5
																		500	4.1	13.5
																		750	5.1	16.7
																		862	5.5	18.0
																		1000	6.0	19.7
																		1450	7.8	25.6
																		1800	8.6	28.2
																		2250	9.8	32.2

Sweep tested 950 MHz to 2.25 GHz.

Series 6 • 18 AWG Solid .040" Bare Copper Conductor • Duobond + Aluminum Braid Shields (60% and 40% Coverage)

Gas-injected Foam Polyethylene Insulation • PVC Jacket (Black or White)

	7916A	NEC: CATV CM	U-500	U-152.4	18.5	8.4	18 AWG (solid) .040"	.180	4.57	Duobond IV* 60% & 40%	.298	7.57	75	83%	16.2	53.1	5	.5	1.6
																	55	1.4	4.6
																	211	2.6	8.5
																	500	4.1	13.5
																	750	5.1	16.7
																	862	5.5	18.0
																	1000	6.0	19.7
																	1450	7.8	25.6
																	1800	8.6	28.2
																	2250	9.8	32.2

BC = Bare Copper • BCCS = Bare Copper-covered Steel • DCR = DC Resistance

*Duobond II = Bonded Duofoil® (100% coverage) + aluminum braid (67% coverage).

Duobond Plus = Bonded Duofoil (100% coverage) + aluminum braid (67% coverage) + shorting fold.

Duobond IV = Bonded Duofoil (100% coverage) + aluminum braid (67% coverage) + Duofoil (100% coverage) + aluminum braid (46% coverage).

Standard Analog Video Cable

75 Ohm Miniature Coax



Description	Part No.	UL NEC/ C(UL) CEC Type	Standard Lengths		Standard Unit Weight		Conductor (stranding) Diameter Nom. DCR	Nominal Core OD		Shielding Materials Nom. DCR	Nominal OD		Nom. Imp. (Ω)	Nom. Vel. of Prop.	Nominal Capacitance		Nominal Attenuation		
			Ft.	m	Lbs.	kg		Inch	mm		Inch	mm			pF/Ft.	pF/m	MHz	dB/100 Ft.	dB/100m

30 AWG Stranded (7x38) .012" Tinned Copper Conductor • Tinned Copper Braid Shield (89% Coverage)

Foam HDPE Insulation • Black PVC Jacket																			
UL AWM	9221	—	100	30.5	1.5	.7	30 AWG	.058	1.47	TC Braid	.097	2.46	75	78%	17.3	56.8	1	.7	2.3
Style 1375			U-500	U-152.4	4.0	1.8	(7x38)			89% Shield							3.6	1.3	4.3
(30V 60°C)			500	152.4	4.0	1.8	.012"			Coverage							4	1.3	4.3
							TC			11.7Ω/M'							5	1.6	5.2
							100.0Ω/M'			38.4Ω/km							7	1.9	6.2
							328.0Ω/km										9	2.1	6.9
																	10	2.2	7.2
																	50	5.1	16.7
																	70	6.1	20.0
																	100	7.3	23.9
																	200	10.5	34.4
																	400	15.5	50.9
																	700	21.5	70.5
																	900	24.8	81.4
																	1000	26.6	87.3

27 AWG Stranded (7x35) .017" Bare Copper-covered Steel Conductor • Tinned Copper Braid Shield (93% Coverage)

Polyethylene Insulation • Black PVC Jacket																			
UL AWM	8218	—	U-500	U-152.4	8.5	3.8	27 AWG	.100	2.54	TC Braid	.150	3.81	75	66%	20.5	67.3	1	1.2	3.9
Style 1354			500	152.4	8.0	3.6	(7x35)			93% Shield							10	2.4	7.9
(30V 60°C)			U-1000	U-304.8	16.0	7.3	.017"			Coverage							50	4.2	13.8
			1000	304.8	14.0	6.4	BCCS			5.7Ω/M'							100	5.7	18.7
							120.0Ω/M'			18.7Ω/km							200	8.3	27.2
							393.7Ω/km										400	12.1	39.7
																	700	16.5	54.1
																	900	19.0	62.3
																	1000	20.0	65.6

Miniature • 25 AWG Solid .018" Tinned Copper Conductors • Duobond® (100% Coverage) + TC Braid Shield (95% Coverage)

Gas-injected Foam HDPE Insulation • Black PVC Jacket																			
UL AWM	1281R	NEC: 1	1000	304.8	8.0	3.6	25 AWG	.074	1.88	Duobond	.114	2.90	75	80%	17.0	55.8	1	.5	1.7
	new	CMR					(solid)			(100%)							5	1.2	3.8
		CEC:					.018"			+ 95%							50	3.7	12.1
		CMG					TC			TC Braid							100	4.9	16.1
							34.0Ω/M'			5.4Ω/M'							200	6.7	22.0
							111.6Ω/km			17.7Ω/km							400	9.5	31.2
																	700	13.4	44.0
																	900	15.0	49.2
																	1000	15.8	51.8
																	3000	31.2	102.4

Plenum • FPFA Insulation • Black Flamarrest® Jacket																			
UL AWM	1282P	NEC: 1	1000	304.8	10.0	4.5	25 AWG	.074	1.88	Duobond	.114	2.90	75	81%	17.0	55.8	1	.4	1.3
	new	CMP					(solid)			(100%)							5	.9	3.0
		CEC:					.018"			+ 95%							50	3.7	12.1
		CMP FT6					TC			TC Braid							100	5.0	16.4
							31.8Ω/M'			5.8Ω/M'							200	7.0	23.0
							104.3Ω/km			19.0Ω/km							400	10.0	32.8
																	700	14.5	47.6
																	900	17.0	55.8
																	1000	17.5	57.4
																	3000	37.0	121.4

BCCS = Bare Copper-covered Steel • DCR = DC Resistance • FPFA = Foam Perfluoroalkoxy • HDPE = High-density Polyethylene • TC = Tinned Copper

Standard Analog Video Cable

RG-59/U Type



Description	Part No.	UL NEC/ C(UL) CEC Type	Standard Lengths		Standard Unit Weight		Conductor (stranding) Diameter Nom. DCR	Nominal Core OD		Shielding Materials Nom. DCR	Nominal OD		Nom. Imp. (Ω)	Nom. Vel. of Prop.	Nominal Capacitance		Nominal Attenuation		
			Ft.	m	Lbs.	kg		Inch	mm		Inch	mm			pF/Ft.	pF/m	MHz	dB/ 100 Ft.	dB/ 100m

23 AWG Solid .023" Bare Copper or Bare Copper-covered Steel Conductor (see below) • Bare Copper Braid Shield (95% Coverage)

Polyethylene Insulation • Black PVC Jacket																			
UL AWM	8241	NEC:	100	30.5	4.4	2.0	23 AWG	.146	3.71	BC Braid	.240	6.10	75	66%	20.5	67.3	1	.6	2.0
Style 1354		CM	U-500	U-152.4	19.5	8.9	(solid)			95% Shield							10	1.1	3.6
(30V 75°C)			500	152.4	18.5	8.4	.023"			Coverage							50	2.4	7.9
VW-1			U-1000 [▲]	U-304.8	38.0	17.2	BCCS			2.6Ω/M'							100	3.4	11.2
			1000	304.8	40.0	18.1	49.0Ω/M'			8.5Ω/km							200	4.9	16.1
			2000	609.6	80.0	36.3	160.7Ω/km										400	7.0	23.0
			5000	1524.0	200.0	90.7											700	9.7	31.8
																	900	11.1	36.4
																	1000	12.0	39.4

[▲]U-1000 ft. put-up also available in Red, Yellow, Green, Lt. Blue, White or Orange.

Flame-retardant Semi-foam Polyethylene Insulation • Black PVC Jacket

UL AWM	8241A	NEC:	U-1000	U-304.8	40.0	18.1	23 AWG	.146	3.71	BC Braid	.242	6.15	75	66%	20.5	67.3	1	.6	2.0
Style 1354		CMG	1000	304.8	42.0	19.1	(solid)			95% Shield							5	.9	3.0
(30V 75°C)		CEC:					.023"			Coverage							10	1.1	3.6
		CMG FT4					BCCS			2.6Ω/M'							50	2.4	7.9
							49.0Ω/M'			8.5Ω/km							100	3.4	11.2
							160.7Ω/km										200	4.9	16.1
																	400	7.0	23.0
																	700	10.1	33.1
																	900	11.7	38.4
																	1000	13.2	43.3

Suitable for Indoor and Outdoor applications.

Polyethylene Insulation • Black PVC Jacket

UL AWM	8241B	NEC:	U-1000	U-304.8	36.0	16.3	23 AWG	.146	3.71	BC Braid	.242	6.15	75	66%	20.5	67.3	1	.4	1.3
Style 1354		CM	1000	304.8	37.0	16.8	(solid)			95% Shield							10	1.1	3.6
(30V 80°C)		CEC:					.023"			Coverage							50	2.4	7.9
		CM					BC			2.9Ω/M'							100	3.4	11.2
							20.4Ω/M'			9.5Ω/km							200	4.9	16.1
							66.9Ω/km										400	7.0	23.0
																	700	9.7	31.8
																	900	11.1	36.4
																	1000	12.0	39.4

Suitable for Indoor and Outdoor applications.

22 AWG Stranded (7x30) .030" Bare Copper Conductor • Bare Copper Braid Shield (95% Coverage)

Foam Polyethylene Insulation • PVC Jacket (Available in Matte Black, Red, Blue, Green, White, Gray or Yellow)																			
High-Flex	8241F	—	1000	304.8	35.0	15.9	22 AWG	.146	3.71	BC Braid	.242	6.15	75	78%	17.3	56.8	1	.3	1.0
60°C							(7x30)			95% Shield							10	.9	3.0
							.030"			Coverage							50	2.1	6.9
							BC			2.6Ω/M'							100	3.0	9.8
							15.0Ω/M'			8.5Ω/km							200	4.5	14.8
							49.2Ω/km										400	6.6	21.7
																	700	8.9	29.2
																	900	10.1	33.1
																	1000	10.9	35.8

23 AWG Solid .023" Bare Copper-covered Steel Conductor • Bare Copper Braid Shield (97% Coverage)

Plenum • FEP Insulation • Black FEP Jacket																			
200°C	88241	NEC:	500 [†]	152.4	18.0	8.2	23 AWG	.132	3.35	BC Braid	.190	4.83	75	69.5%	19.5	64.0	1	.5	1.6
		CMP	1000 [†]	304.8	36.0	16.3	(solid)			97% Shield							10	1.0	3.3
		CEC:					.023"			Coverage							50	2.3	7.5
		CMP FT6					BCCS			2.6Ω/M'							100	3.3	10.8
							49.0Ω/M'			8.5Ω/km							200	5.2	17.1
							160.7Ω/km										400	8.4	27.6
																	700	11.6	38.0
																	900	13.8	45.3
																	1000	14.8	48.6

Suitable for Outdoor and Direct Burial applications.

Plenum • FEP Insulation • Natural Flammarrest® Jacket

75°C	82241	NEC:	U-500 [†]	U-152.4	18.5	8.4	23 AWG	.134	3.35	BC Braid	.190	4.83	75	69.5%	19.5	64.0	1	.5	1.6
		CMP	U-1000 [†]	U-304.8	36.0	16.3	(solid)			97% Shield							10	1.0	3.3
		CEC:	1000 [†]	304.8	34.0	15.4	.023"			Coverage							50	2.3	7.5
		CMP FT6					BCCS			2.6Ω/M'							100	3.3	10.8
							49.0Ω/M'			8.5Ω/km							200	5.2	17.1
							160.7Ω/km										400	8.4	27.6
																	700	11.6	38.0
																	900	13.8	45.3
																	1000	14.8	48.6

BC = Bare Copper • BCCS = Bare Copper-covered Steel • DCR = DC Resistance • FEP = Fluorinated Ethylene Propylene

Contact the Belden Customer Service Department for a Comprehensive Connector Cross Reference. **1-800-BELDEN-1**. Request quotations of RG/U cables not listed.

[†]Spools and/or UnReel® cartons are one piece, but length may vary ±10% from length shown.



For more information, contact **Belden Technical Support: 1-800-BELDEN-1 • www.belden.com**

Standard Analog Video Cable

RG-59/U Type



Description	Part No.	UL NEC/ C(UL) CEC Type	Standard Lengths		Standard Unit Weight		Conductor (stranding) Diameter Nom. DCR	Nominal Core OD		Shielding Materials Nom. DCR	Nominal OD		Nom. Imp. (Ω)	Nom. Vel. of Prop.	Nominal Capacitance		Nominal Attenuation		
			Ft.	m	Lbs.	kg		Inch	mm		Inch	mm			pF/Ft.	pF/m	MHz	dB/ 100 Ft.	dB/ 100m

22 AWG Solid Bare Copper-covered Steel Conductor • Bare Copper Braid Shield (95% Coverage)

Polyethylene Insulation • Black PVC Jacket

UL AWM Style 1354 (30V 60°C)	8263	NEC: CMX CEC: CMX	U-500 U-1000 1000	U-152.4 U-304.8 304.8	19.5 38.0 39.0	8.2 17.2 17.7	22 AWG (solid) .023" BCCS 49.0Ω/M' 160.7Ω/km	.146 3.71	BC Braid 95% Shield Coverage 2.6Ω/M' 8.5Ω/km	.242 6.15	75 66%	20.5 67.3	1 10 50 100 200 400 700 900 1000	.6 1.1 2.4 3.4 4.9 7.0 9.7 11.1 12.0	2.0 3.6 7.9 11.2 16.1 23.0 31.8 36.4 39.4
------------------------------------	-------------	----------------------------	-------------------------	-----------------------------	----------------------	---------------------	---	--------------	--	--------------	-----------	--------------	--	--	---



Non-contaminating Black PVC Jacket. Suitable for Indoor and Outdoor applications.

Foam Polyethylene Insulation • Black PVC Jacket

75°C	8221	—	U-500 500 U-1000 1000	U-152.4 152.4 U-304.8 304.8	18.5 17.0 36.0 37.0	8.2 7.7 16.3 16.8	22 AWG (solid) .025" BCCS 50.0Ω/M' 164.0Ω/km	.146 3.71	BC Braid 95% Shield Coverage 2.6Ω/M' 8.5Ω/km	.242 6.15	80 78%	16.3 53.5	1 10 50 100 200 400 700 900 1000	.4 .9 2.0 2.9 4.1 5.9 7.8 8.8 9.9	1.4 3.0 6.6 9.5 13.5 19.4 25.6 28.9 32.5
------	-------------	---	--------------------------------	--------------------------------------	------------------------------	----------------------------	---	--------------	--	--------------	-----------	--------------	--	---	--



Suitable for Outdoor and Aerial applications when supported by a Messenger Wire.

22 AWG Solid Bare Copper-covered Steel Conductor • Bare Copper Braid Shield (85% Coverage)

Polyethylene Insulation • Black PVC Jacket

UL AWM Style 1354 (30V 80°C)	9244	NEC: CMX CEC: CMX	U-500 U-1000 1000 3280	U-152.4 U-304.8 304.8 1000.0	18.0 35.0 36.0 118.1	8.2 15.9 16.3 53.8	22 AWG (solid) .025" BCCS 50.0Ω/M' 164.0Ω/km	.146 3.71	BC Braid 85% Shield Coverage 4.5Ω/M' 14.8Ω/km	.242 6.15	75 66%	19.4 63.6	1 10 50 100 200 400 700 900 1000	.6 1.1 2.4 3.4 4.9 7.0 9.7 11.1 12.0	2.0 3.6 7.9 11.2 16.1 23.0 31.8 36.4 39.4
------------------------------------	-------------	----------------------------	---------------------------------	---------------------------------------	-------------------------------	-----------------------------	---	--------------	---	--------------	-----------	--------------	--	--	---



Suitable for Indoor and Outdoor applications.

22 AWG Stranded (7x30) .030" Bare Copper Conductor • Bare Copper Braid Shield (95% Coverage)

Foam Polyethylene Insulation • Black PVC Jacket

UL AWM Style 1354 (30V 60°C) VW-1	9659	NEC: CMX CEC: CMX	U-500 U-1000 1000	U-152.4 U-304.8 304.8	19.0 37.0 38.0	8.6 16.8 17.2	22 AWG (7x30) .030" BC 15.0Ω/M' 49.2Ω/km	.146 3.71	BC Braid 95% Shield Coverage 2.6Ω/M' 8.5Ω/km	.242 6.15	75 78%	17.3 56.7	1 10 50 100 200 400 700 900 1000	.3 .9 2.1 3.0 4.5 6.6 8.9 10.1 10.9	1.0 3.0 6.9 9.8 14.8 21.7 29.2 33.1 35.8
--	-------------	----------------------------	-------------------------	-----------------------------	----------------------	---------------------	---	--------------	--	--------------	-----------	--------------	--	---	--

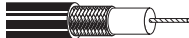

Non-contaminating PVC Jacket. For CCTV applications. Suitable for Indoor and Outdoor applications.

UL AWM Style 1354 (30V 80°C)	9259	NEC: CM CEC: CM	100 U-500 500 U-1000 1000	30.5 U-152.4 152.4 U-304.8 304.8	4.1 8.2 7.5 15.9 16.8	1.9 8.2 7.5 15.9 16.8	22 AWG (7x30) .030" BC 15.0Ω/M' 49.2Ω/km	.146 3.71	BC Braid 95% Shield Coverage 2.6Ω/M' 8.5Ω/km	.241 6.12	75 78%	17.3 56.7	1 10 50 100 200 400 700 900 1000	.3 .9 2.1 3.0 4.5 6.6 8.9 10.1 10.9	1.0 3.0 6.9 9.8 14.8 21.7 29.2 33.1 35.8
------------------------------------	-------------	--------------------------	---------------------------------------	--	-----------------------------------	-----------------------------------	---	--------------	--	--------------	-----------	--------------	--	---	--



For CCTV applications. Suitable for Indoor and Outdoor applications.

Plenum • Foam FEP Insulation • Black FEP Jacket

200°C	89259	NEC: CMP CEC: CMP FT6	100† 500† 1000†	30.5 152.4 304.8	5.1 16.0 32.0	2.3 7.3 14.5	22 AWG (7x30) .030" BC 15.0Ω/M' 49.2Ω/km	.135 3.43	BC Braid 95% Shield Coverage 2.6Ω/M' 8.5Ω/km	.193 4.90	75 78%	17.3 56.7	1 10 50 100 200 400 700 900 1000	.3 .9 2.1 3.0 4.5 6.6 9.0 10.1 11.0	1.0 3.0 6.9 9.8 14.8 21.7 29.5 33.1 36.1
-------	--------------	--------------------------------	-----------------------	------------------------	---------------------	--------------------	---	--------------	--	--------------	-----------	--------------	--	---	--



Suitable for Outdoor and Direct Burial applications.

†Spools and/or UnReel® cartons are one piece, but length may vary ±10% from length shown.

Plenum • Foam FEP Insulation • Natural Flamarrest® Jacket

75°C	82259	NEC: CMP CEC: CMP FT6	U-1000 1000	U-304.8 304.8	31.0 30.0	14.1 13.6	22 AWG (7x30) .030" BC 15.0Ω/M' 49.2Ω/km	.135 3.43	BC Braid 95% Shield Coverage 2.6Ω/M' 8.5Ω/km	.193 4.90	75 78%	17.3 56.7	1 10 50 100 200 400 700 900 1000	.3 .9 2.1 3.0 4.5 6.6 9.0 10.1 11.0	1.0 3.0 6.9 9.8 14.8 21.7 29.5 33.1 36.1
------	--------------	--------------------------------	----------------	------------------	--------------	--------------	---	--------------	--	--------------	-----------	--------------	--	---	--



BC = Bare Copper • BCCS = Bare Copper-covered Steel • DCR = DC Resistance • FEP = Fluorinated Ethylene Propylene

Contact the Belden Customer Service Department for a Comprehensive Connector Cross Reference. 1-800-BELDEN-1. Request quotations of RG/U cables not listed.



For more information, contact Belden Technical Support: 1-800-BELDEN-1 • www.belden.com

Standard Analog Video Cable

RG-59/U Type



Description	Part No.	UL NEC/ C(UL) CEC Type	Standard Lengths		Standard Unit Weight		Conductor (stranding) Diameter Nom. DCR	Nominal Core OD		Shielding Materials Nom. DCR	Nominal OD		Nom. Imp. (Ω)	Nom. Vel. of Prop.	Nominal Capacitance		Nominal Attenuation		
			Ft.	m	Lbs.	kg		Inch	mm		Inch	mm			pF/Ft.	pF/m	MHz	dB/ 100 Ft.	dB/ 100m

20 AWG Solid .032" Bare Copper-covered Steel Conductor • Bare Copper Braid Shield (80% Coverage)

Foam Polyethylene Insulation • Black PVC Jacket																			
75°C	9240	—	1000	304.8	31.0	14.1	20 AWG (solid) .032" BCCS 44.5Ω/M' 146.0Ω/km	.143	3.63	BC Braid 80% Shield Coverage 5.6Ω/M' 18.4Ω/km	.241	6.12	75	78%	17.3	56.7	1	.6	2.0
																	10	1.0	3.3
																	50	2.1	6.9
																	100	3.0	9.8
																	200	4.5	14.8
																	400	6.6	21.7
																	700	8.9	29.2
																	900	10.1	33.1
																	1000	10.9	35.8

Suitable for Outdoor applications.

20 AWG Solid .032" Bare Copper-covered Steel Conductor • Bare Copper Braid Shield (95% Coverage)

Foam Polyethylene Insulation • Black Polyethylene Jacket																			
80°C	8212	—	U-500	U-152.4	16.5	7.5	20 AWG (solid) .032" BCCS 44.5Ω/M' 146.0Ω/km	.143	3.63	BC Braid 95% Shield Coverage 2.6Ω/M' 8.5Ω/km	.242	6.15	75	78%	17.3	56.7	1	.6	2.0
			500	152.4	15.0	6.8											10	1.0	3.3
			U-1000	U-304.8	31.0	14.1											50	2.1	6.9
			1000	304.8	33.0	15.0											100	3.0	9.8
																	200	4.5	14.8
																	400	6.6	21.7
																	700	8.9	29.2
																	900	10.1	33.1
																	1000	10.9	35.8

Suitable for Outdoor and Aerial applications when supported by a Messenger Wire.

Foam Polyethylene Insulation • Black PVC Jacket																			
80°C	9274	NEC: CM CEC: CM	500	152.4	15.5	7.0	20 AWG (solid) .032" BCCS 44.5Ω/M' 146.0Ω/km	.143	3.63	BC Braid 95% Shield Coverage 3.5Ω/M' 11.5Ω/km	.240	6.10	75	82%	16.3	53.5	1	.6	2.0
			1000	304.8	35.0	15.9											10	1.0	3.3
																	50	2.1	6.9
																	100	3.0	9.8
																	200	4.5	14.8
																	400	6.6	21.7
																	700	8.9	29.2
																	900	10.1	33.1
																	1000	10.9	35.8

Suitable for Outdoor applications.

20 AWG Solid .032" Bare Copper Conductor • Bare Copper Braid Shield (95% Coverage)

Gas-injected Foam HDPE Insulation • Black PVC Jacket																			
UL AWM Style 1354 (30V 75°C)	1426A	NEC: CM	U-1000	U-304.8	35.0	15.9	20 AWG (solid) .032" BC 10.0Ω/M' 32.8Ω/km	.145	3.68	BC Braid 95% Shield Coverage 2.6Ω/M' 8.5Ω/km	.242	6.15	75	83%	16.3	53.5	1	.3	1.0
																	5	.7	2.1
																	10	.9	3.0
																	50	1.9	6.2
																	100	2.6	8.5
																	200	3.6	11.8
																	400	5.0	16.4
																	700	7.0	23.0
																	900	8.0	26.3
																	1000	8.5	27.9

BC = Bare Copper • BCCS = Bare Copper-covered Steel • DCR = DC Resistance

Contact the Belden Customer Service Department for a Comprehensive Connector Cross Reference. **1-800-BELDEN-1**. Request quotations of RG/U cables not listed.

Standard Analog Video Cable

RG-6/U Type



Description	Part No.	UL NEC/ C(UL) CEC Type	Standard Lengths		Standard Unit Weight		Conductor (stranding) Diameter Nom. DCR	Nominal Core OD		Shielding Materials Nom. DCR	Nominal OD		Nom. Imp. (Ω)	Nom. Vel. of Prop.	Nominal Capacitance		Nominal Attenuation		
			Ft.	m	Lbs.	kg		Inch	mm		Inch	mm			pF/Ft.	pF/m	MHz	dB/100 Ft.	dB/100m

21 AWG Solid .028" Bare Copper-covered Steel Conductor • Double Bare Copper Braid Shields (98% Coverage)

Polyethylene Insulation • Black Polyethylene Jacket																			
MATV Cable 80°C	8215	—	1000	304.8	74.0	33.6	21 AWG (solid) .028"	.185	4.70	(2) BC Braids 98% Shield Coverage	.332	8.43	75	66%	20.5	67.2	1	.4	1.3
																			
BCCS 32.0Ω/M' 105.0Ω/km																			
100% Sweep tested. 5 MHz to 450 MHz.																			
50 1.9 6.2 100 2.7 8.9 200 4.1 13.4 400 5.9 19.4 700 8.1 26.6 900 9.4 30.8 1000 9.8 32.1																			

18 AWG Solid .037" Bare Copper Conductor • Double Bare Copper Braid Shields (98% Coverage)

Foam Polyethylene Insulation • Black PVC Jacket																			
80°C	9290	NEC: CM CEC: CM	1000 2000	304.8 609.6	59.0 118.0	26.8 53.6	18 AWG (solid) .037"	.180	4.57	(2) BC Braids 98% Shield Coverage	.288	7.32	75	81%	17.3	56.7	1	.2	.7
																			
BC 7.5Ω/M' 24.6Ω/km																			
2.0Ω/M' 7.5Ω/km																			
100% Sweep tested. 5 MHz to 450 MHz.																			
50 1.7 5.6 100 2.5 8.2 200 3.6 11.8 400 5.3 17.4 700 7.2 23.6 900 8.3 27.2 1000 8.8 28.9																			

Suitable for Indoor and Outdoor applications.

18 AWG Solid .040" Bare Copper Conductor • Duofoil® (100% Coverage) + Tinned Copper Braid Shield (65% Coverage)

Plenum • Foam FEP Insulation • Black FEP Jacket																			
200°C	89248	NEC: CMP CEC: CMP FT6	500† 1000† 2000†	152.4 304.8 609.6	15.0 33.0 64.0	6.8 15.0 29.0	18 AWG (solid) .040"	.170	4.32	Duofoil + 65% TC Braid	.222	5.64	75	82%	16.5	50.3	1	.3	1.0
																			
BC 6.4Ω/M' 21.0Ω/km																			
5.1Ω/M' 16.7Ω/km																			
100% Sweep tested. 5 MHz to 450 MHz.																			
50 1.5 4.9 100 2.1 6.9 200 3.1 10.2 400 4.5 14.8 700 6.0 19.7 900 6.9 22.6 1000 7.3 23.9																			

Suitable for Outdoor and Direct Burial applications.

Plenum • Foam FEP Insulation • Natural Flamarrest® Jacket																			
75°C	82248	NEC: CMP CEC: CMP FT6	U-1000† 1000†	U-304.8 304.8	29.0 31.0	13.2 14.1	18 AWG (solid) .040"	.170	4.32	Duofoil + 65% TC Braid	.222	5.64	75	82%	16.5	50.3	1	.3	1.0
																			
BC 6.4Ω/M' 21.0Ω/km																			
5.1Ω/M' 16.7Ω/km																			
100% Sweep tested. 5 MHz to 450 MHz.																			
50 1.6 5.2 100 2.2 7.2 200 3.0 9.8 400 4.6 15.1 700 6.6 21.6 900 7.7 25.3 1000 8.2 26.9																			

18 AWG Solid .040" Bare Copper Conductor • Duofoil® (100% Coverage) + Tinned Copper Braid Shield (60% Coverage)

Gas-injected Foam HDPE Insulation • Black PVC Jacket																			
UL AWM Style 1354 (30V 80°C)	9248	NEC: CM CEC: CM	U-500 500 U-1000 1000 1640 3280	U-152.4 152.4 304.8 304.8 500.0 1000.0	16.5 15.0 14.5 15.0 55.8 108.2	7.5 6.8 14.5 15.0 25.3 49.2	18 AWG (solid) .040"	.180	4.57	Duofoil + 60% TC Braid	.270	6.86	75	82%	16.2	53.1	1	.3	1.0
																			
BC 6.4Ω/M' 21.0Ω/km																			
5.6Ω/M' 18.4Ω/km																			
For Plenum versions of 9248, see 89248 or 82248.																			
50 1.5 4.9 100 2.0 6.6 200 2.8 9.2 400 4.0 13.1 700 5.3 17.4 900 6.1 20.0 1000 6.5 21.3 1500 8.3 27.2																			

BC = Bare Copper • BCCS = Bare Copper-covered Steel • DCR = DC Resistance • FEP = Fluorinated Ethylene Propylene • HDPE = High-density Polyethylene • TC = Tinned Copper • UTP = Unshielded Twisted Pair
Contact the Belden Customer Service Department for a Comprehensive Connector Cross Reference. **1-800-BELDEN-1**. Request quotations of RG/U cables not listed.

†Spools and/or UnReel® cartons are one piece, but length may vary ±10% from length shown.



Standard Analog Video Cable

RG-6/U and RG-11/U Types



Description	Part No.	UL NEC/C(UL) CEC Type	Standard Lengths		Standard Unit Weight		Conductor (stranding) Diameter Nom. DCR	Nominal Core OD		Shielding Materials Nom. DCR	Nominal OD		Nom. Imp. (Ω)	Nom. Vel. of Prop.	Nominal Capacitance		Nominal Attenuation		
			Ft.	m	Lbs.	kg		Inch	mm		Inch	mm			pF/Ft.	pF/m	MHz	dB/100 Ft.	dB/100m

RG-6/U • 18 AWG Stranded (7x26) .048" Tinned Copper Conductor • Bare Copper Braid Shield (97% Coverage)

Flame-retardant Semi-foam Polyethylene Insulation • Black PVC Jacket

80°C	8238	NEC: CM CEC: CM	500 1000	152.4 304.8	59.0 117.0	26.8 53.1	18 AWG (7x26) .048" TC 6.1Ω/M' 20.0Ω/km	.285 7.24	BC Braid 97% Shield Coverage 1.2Ω/M' 3.9Ω/km	.405 10.29	75	67%	20.5	67.2	1 10 50 100 200 400 700 900 1000	.2 .7 1.3 2.0 2.9 4.2 5.8 6.8 7.1	.6 2.2 4.3 6.6 9.5 13.8 19.0 22.3 23.3
------	-------------	--------------------	-------------	----------------	---------------	--------------	---	--------------	--	---------------	----	-----	------	------	--	---	--

Suitable for Indoor and Outdoor applications.

Polyethylene Insulation • Black PVC Jacket

60°C	8261	CEC: CXC	500 1000	152.4 304.8	52.5 104.0	23.9 47.3	18 AWG (7x26) .048" TC 6.1Ω/M' 20.0Ω/km	.285 7.24	BC Braid 97% Shield Coverage 1.2Ω/M' 3.9Ω/km	.405 10.29	75	66%	20.5	67.2	1 10 50 100 200 400 700 900 1000	.2 .7 1.3 2.0 2.9 4.2 5.8 6.8 7.1	.6 2.2 4.3 6.6 9.5 13.8 19.0 22.3 23.3
------	-------------	----------	-------------	----------------	---------------	--------------	---	--------------	--	---------------	----	-----	------	------	--	---	--

Suitable for Indoor and Outdoor applications.

Composite • Coax: 18 AWG Solid BC Cond. w/BC Braid Shield (95% Coverage) • **Power: 18 AWG** Stranded (7x26) BC Conductor UTP

Foam Polyethylene Insulation (Coax) • Polypropylene Insulation (Pair) • Black Low-Smoke, Zero-Halogen Jacket

Siamese 300V RMS	1306SB <small>new</small>	NEC: CMG-LS CEC: CMG-LS FT4 Limited Smoke	500 1000	152.4 304.8	37.0 76.0	16.8 34.5	18 AWG (solid) .040" BC 6.4Ω/M' 21.0Ω/km	Coax: .180 4.57 Pair: .059 1.59 (Color Code: Black & Red)	Coax: .275 6.99 75 83% 16.3 53.5	95% BC Braid 3.1Ω/M' 10.2Ω/km	.405 10.29	75	83%	16.3	53.5	1 10 50 100 200 400 700 900 1000	.2 .6 1.5 2.1 3.0 4.3 5.8 6.7 7.1	.7 2.1 4.8 6.9 9.8 14.1 19.0 22.0 23.3
------------------	-------------------------------------	--	-------------	----------------	--------------	--------------	--	---	---	-------------------------------------	---------------	----	-----	------	------	--	---	--

RG-11/U • 14 AWG Solid .064" Bare Copper Conductor • Duofoil® (100% Coverage) + Tinned Copper Braid Shield (60% Coverage)

Gas-injected Foam HDPE Insulation • Black PVC Jacket

80°C	9292	—	1000	304.8	75.0	34.0	14 AWG (solid) .064" BC 2.6Ω/M' 8.5Ω/km	.280 7.11	Duofoil + 60% TC Braid 3.0Ω/M' 9.8Ω/km	.405 10.29	75	84%	16.1	52.8	1 10 50 100 200 400 700 900 1000	.2 .5 .9 1.3 1.6 2.3 3.3 4.0 4.3	.6 1.6 3.0 4.3 5.3 7.6 10.8 13.1 14.1
------	-------------	---	------	-------	------	------	---	--------------	--	---------------	----	-----	------	------	--	--	---

For Plenum versions of 9292, see 89292.
100% Sweep tested. 5 MHz to 450 MHz.

Suitable for Indoor and Outdoor applications.

RG-11/U • 14 AWG Solid .064" Bare Copper Conductor • Duofoil (100% Coverage) + Tinned Copper Braid Shield (63% Coverage)

Plenum • Foam FEP Insulation • Black FEP Jacket

200°C	89292	NEC: CMP CATVP CEC: CMP FT6	500 1000	152.4 304.8	40.5 81.0	18.4 36.7	14 AWG (solid) .064" BC 2.5Ω/M' 8.2Ω/km	.274 6.96	Duofoil + 63% TC Braid 3.0Ω/M' 9.8Ω/km	.346 8.79	75	83%	16.2	53.1	1 10 50 100 200 400 700 900 1000	.2 .4 1.0 1.5 2.2 3.3 4.5 5.2 5.5	.5 1.3 3.3 4.9 7.2 10.8 14.8 17.1 18.0
-------	--------------	-----------------------------------	-------------	----------------	--------------	--------------	---	--------------	--	--------------	----	-----	------	------	--	---	--

100% Sweep tested. 5 MHz to 450 MHz.

RG-11/U • 14 AWG Solid .064" Bare Copper Conductor • Bare Copper Braid Shield (97% Coverage)

Gas-injected Foam HDPE Insulation • Black Polyethylene Jacket

80°C	8213	—	500 1000 2000	152.4 304.8 609.6	44.0 87.0 172.0	20.0 39.5 78.2	14 AWG (solid) .064" BC 2.6Ω/M' 8.5Ω/km	.285 7.24	BC Braid 97% Shield Coverage 1.1Ω/M' 3.6Ω/km	.405 10.29	75	84%	16.1	52.8	1 10 50 100 200 400 700 900 1000	.2 .4 .9 1.3 1.9 2.9 4.1 4.8 5.2	.6 1.1 3.0 4.3 6.2 9.5 13.5 15.7 17.1
------	-------------	---	---------------------	-------------------------	-----------------------	----------------------	---	--------------	--	---------------	----	-----	------	------	--	--	---

100% Sweep tested. 5 MHz to 450 MHz.

Suitable for Indoor and Outdoor applications.

BC = Bare Copper • DCR = DC Resistance • FEP = Fluorinated Ethylene Propylene • HDPE = High-density Polyethylene • TC = Tinned Copper

Contact the Belden Customer Service Department for a Comprehensive Connector Cross Reference. 1-800-BELDEN-1. Request quotations of RG/U cables not listed.



For more information, contact Belden Technical Support: 1-800-BELDEN-1 • www.belden.com

Precision Video Cable for Analog and Digital

Sub-Miniature RG-59/U Type



Description	Part No.	UL NEC/ C(UL) CEC Type	Standard Lengths		Standard Unit Weight		Conductor (stranding) Diameter Nom. DCR	Nominal Core OD		Shielding Materials Nom. DCR	Nominal OD		Nom. Imp. (Ω)	Nom. Vel. of Prop.	Nominal Capacitance		Nominal Attenuation		
			Ft.	m	Lbs.	kg		Inch	mm		Inch	mm			pF/Ft.	pF/m	MHz	dB/100 Ft.	dB/100m

25 AWG Stranded (19x37) .021" Bare Copper Conductor • Duofoil® (100% Coverage) + Tinned Copper Braid Shield (95% Coverage)

Gas-injected Foam HDPE Insulation • PVC Jacket (Available in 10 colors)*

75°C	1865A	NEC: CMR CEC: CMG FT4	1000	304.8	14.0	6.4	25 AWG (19x37) .021" BC 27.4Ω/M' 89.9Ω/km	.094	2.39	Duofoil + 95% TC Braid 5.4Ω/M' 17.7Ω/km	.150	3.81	75	82%	16.5	54.1	1	.5	1.5
																	3.6	1.0	3.1
																	10	1.6	5.2
																	71.5	3.7	12.1
																	135	5.0	16.4
																	270	7.1	23.3
																	360	8.2	26.9
																	540	10.1	33.1
																	720	11.8	38.7
																	750	12.0	39.4
																	1000	13.9	45.6
																	1500	17.0	55.8
																	2250	20.8	68.2
																	3000	24.0	78.7

23 AWG Solid .023" Bare Copper Conductor • Duofoil (100% Coverage) + Tinned Copper Braid Shield (95% Coverage)

Gas-injected Foam HDPE Insulation • PVC Jacket (Available in 10 colors)*

SDI/HDTV Digital Video 75°C	1855A	NEC: CMR CEC: CMG FT4	500 [▲]	152.4	9.0	4.1	23 AWG (solid) .023" BC 20.1Ω/M' 65.9Ω/km	.102	2.59	Duofoil + 95% TC Braid 7.6Ω/M' 24.9Ω/km	.159	4.03	75	82%	16.3	53.5	1	.4	1.3
																	3.6	.8	2.6
																	10	1.2	3.9
																	71.5	3.1	10.0
																	135	3.8	12.5
																	270	5.4	17.7
																	360	6.2	20.3
																	540	7.7	25.3
																	720	9.5	31.1
																	750	9.6	31.5
																	1000	10.5	34.4
																	1500	13.0	42.6
																	2250	16.0	52.5
																	3000	18.5	60.7

*500 ft. put-up available in Black only.

BC = Bare Copper • DCR = DC Resistance • HDPE = Foam High-density Polyethylene • TC = Tinned Copper

Contact the Belden Customer Service Department for a Comprehensive Connector Cross Reference. **1-800-BELDEN-1**. Request quotations of RG/U cables not listed.

*Available in Brown, Red, Orange, Yellow, Green, Blue, Purple, Gray, White or Black.

Precision Video Cable for Analog and Digital

RG-59/U Type



Description	Part No.	UL NEC/ C(UL) CEC Type	Standard Lengths		Standard Unit Weight		Conductor (stranding) Diameter Nom. DCR	Nominal Core OD		Shielding Materials Nom. DCR	Nominal OD		Nom. Imp. (Ω)	Nom. Vel. of Prop.	Nominal Capacitance		Nominal Attenuation		
			Ft.	m	Lbs.	kg		Inch	mm		Inch	mm			pF/Ft.	pF/m	MHz	dB/100 Ft.	dB/100m

23 AWG Stranded (7x32) .023" Bare Compacted Copper* • Tinned Copper Braid Shield (95% Coverage)

Polyethylene Insulation • Black Polyethylene Jacket																			
80°C	8279	—	500	152.4	13.0	5.9	23 AWG (7x32) .023" BCC 19.1Ω/M' 62.6Ω/km	.146	3.71	TC + 95% Shield Coverage 4.5Ω/M' 14.8Ω/km	.220	5.59	75	66%	21.0	68.9	1	.4	1.1
			1000	304.8	29.0	13.2											3.6	.6	2.0
100% Sweep tested.																			
270 6.8 22.3																			
360 8.0 26.2																			
540 9.9 32.5																			
720 11.6 38.0																			
750 11.9 39.0																			
1000 13.8 45.3																			

23 AWG Solid .022" Bare Copper Conductor • Duofoil® (100% Coverage) + Tinned Copper Braid Shield (95% Coverage)

Polyethylene Insulation • Black Polyethylene Jacket																			
80°C	9209	—	U-500	U-152.4	15.0	6.8	23 AWG (solid) .022" BC 20.4Ω/M' 66.9Ω/km	.146	3.71	Duofoil + 95% TC Braid BC 4.5Ω/M' 14.8Ω/km	.220	5.59	75	66%	21.0	68.9	1	.4	1.2
			U-1000	U-304.8	29.0	13.2											3.6	.5	1.8
100% Sweep tested.																			
270 5.6 18.4																			
360 6.6 21.5																			
540 8.3 27.2																			
720 9.7 31.7																			
750 9.9 32.5																			
1000 11.6 38.0																			

Flame-retardant Semi-foam Polyethylene Insulation • Black PVC Jacket																			
UL AWM Style 1354 (30V 75°C)	9209A	NEC: CMR CEC: CMG FT4	U-1000	U-304.8	35.0	15.9	23 AWG (solid) .022" BC 20.4Ω/M' 66.9Ω/km	.146	3.71	Duofoil + 95% TC Braid BC 4.5Ω/M' 14.8Ω/km	.220	5.59	75	66%	20.5	67.2	1	.4	1.2
																	3.6	.5	1.8
100% Sweep tested.																			
270 5.6 18.4																			
360 6.6 21.5																			
540 8.6 28.3																			
720 10.1 33.2																			
750 10.4 34.1																			
1000 12.8 41.9																			

BC = Bare Copper • BCC = Bare Compacted Copper • DCR = DC Resistance • HDPE = High-density Polyethylene • TC = Tinned Copper

Contact the Belden Customer Service Department for a Comprehensive Connector Cross Reference. **1-800-BELDEN-1**. Request quotations of RG/U cables not listed.

*Compacted conductor combines impedance uniformity of solid conductors and "nick-resistance" of stranded conductor.

Precision Video Cable for Analog and Digital

RG-59/U Type



Description	Part No.	UL NEC/ C(UL) CEC Type	Standard Lengths		Standard Unit Weight		Conductor (stranding) Diameter Nom. DCR	Nominal Core OD		Shielding Materials Nom. DCR	Nominal OD		Nom. Imp. (Ω)	Nom. Vel. of Prop.	Nominal Capacitance		Nominal Attenuation		
			Ft.	m	Lbs.	kg		Inch	mm		Inch	mm			pF/Ft.	pF/m	MHz	dB/100 Ft.	dB/100m

20 AWG Solid .032" Bare Copper Conductor • Duofoil® (100% Coverage) + Tinned Copper Braid Shield (95% Coverage)

Gas-injected Foam HDPE Insulation • PVC Jacket (Available in 10 colors)*

SDI/HDTV	1505A	NEC:	500 [▲]	152.4	17.0	8.0	20 AWG (solid)	.145	3.68	Duofoil + 95%	.233	5.92	75	83%	16.3	53.5	1	.3	1.0
Digital Video		CMR:	1000	304.8	35.0	16.4	.032"			TC Braid							3.6	.6	1.8
75°C		CEC:	5000 [▼]	1524.0	165.0	74.8	10.0Ω/M'			3.8Ω/M'							10	.9	2.9
		CMG FT4					32.8Ω/km			12.5Ω/km							71.5	2.1	6.9
										For Plenum version of 1505A, see 1506A.							135	2.7	8.9
										Also available in bundled versions. See 7794A through 7798A.							270	3.8	12.5
										100% Sweep tested. 5 MHz to 3 GHz.							360	4.4	14.4
																	540	5.5	18.0
																	720	6.4	21.0
																	750	6.5	21.3
																	1000	7.6	24.9
																	1500	9.3	30.5
																	2250	11.6	38.0
																	3000	13.4	44.0

*500 ft. put-up available in Black, Red or Blue only.

▼5000 ft. put-up may vary in length by -0 to +10%.

▲1000 ft. and 5000 ft. put-ups available in all ten colors: Black, Brown, Red, Orange, Yellow, Green, Blue, Purple, Gray or White.

22 AWG Stranded (7x29) .031" Bare Compacted Copper Conductor* • Tinned Copper/Bare Copper Double Braid Shield (95% Coverage)

Gas-injected Foam HDPE Insulation • PVC Jacket (Matte Black, Red, Green, Blue, Yellow, Orange, White or Purple)

High-Flex	1505F	NEC:	1000	304.8	45.0	20.4	22 AWG (7x29)	.145	3.68	TC Double Braid	.242	6.15	75	80%	17.0	55.7	1	.2	.7
SDI/HDTV		CM					.031"			95% Shield							3.6	.5	1.6
Video Patch		CEC:					12.2Ω/M'			BCC Coverage							71.5	2.5	8.2
75°C		CM					40.0Ω/km			7.8Ω/km							135	3.5	11.5
										100% Sweep tested. 5 MHz to 3 GHz.							270	5.1	16.7
																	360	6.0	19.7
																	540	7.4	24.3
																	720	8.7	28.5
																	750	8.9	29.2
																	1000	10.5	34.4
																	1500	13.3	43.6
																	2250	16.9	55.4
																	3000	20.3	66.6

*Compacted conductor combines impedance uniformity of solid conductors and "nick-resistance" of stranded conductor.

20 AWG Solid .032" Bare Copper Conductor • Duofoil (100% Coverage) + Tinned Copper Braid Shield (95% Coverage)

Plenum • Foam FEP Insulation • Flamarest® Jacket (Available in 10 colors)*

SDI/HDTV	1506A	NEC:	500 ^{†*}	152.4	14.5	6.6	20 AWG (solid)	.133	3.38	Duofoil + 95%	.196	4.93	75	84%	16.1	52.8	1	.3	1.0
Digital Video		CMP:	1000 ^{†*}	304.8	29.0	13.2	.032"			TC Braid							3.6	.6	2.0
75°C		CEC:					10.0Ω/M'			3.8Ω/M'							71.5	2.3	7.4
		CMF FT6					32.8Ω/km			10.5Ω/km							135	3.2	10.5
										100% Sweep tested. 5 MHz to 3 GHz.							270	4.6	14.9
																	360	5.3	17.2
																	540	6.4	21.0
																	720	7.3	23.9
																	750	7.5	24.6
																	1000	9.4	30.8
																	1500	12.8	42.0
																	2250	17.5	57.4
																	3000	21.9	71.8

Suitable for Outdoor and Direct Burial applications.

*500 ft. put-up available in Black or Natural only.

†1000 ft. put-up available in all ten colors: Black, Brown, Red, Orange, Yellow, Green, Blue, Purple, Gray or Natural.

20 AWG Solid .031" Bare Copper Conductor • Tinned Copper/Bare Copper Double Braid Shield (98% Coverage)

Polyethylene Insulation • Gray PVC Jacket

60°C	9231	NEC:	500	152.4	39.0	17.7	20 AWG (solid)	.198	5.03	TC Double Braid	.305	7.75	75	66%	21.0	68.9	1	.3	1.0
VW-1		CMH:	1000	304.8	76.0	34.5	.031"			98% Shield							10.0	.8	2.6
		CEC:					9.9Ω/M'			1.1Ω/M'							71.5	2.0	6.6
		CMH FT1					32.5Ω/km			3.6Ω/km							135	3.5	11.5
										100% Sweep tested. 5 MHz to 850 MHz.							270	4.3	14.1
																	360	5.0	16.4
																	540	6.2	20.3
																	720	7.2	23.6
																	750	7.4	24.3
																	1000	9.1	29.8

BC = Bare Copper • BCC = Bare Compacted Copper • DCR = DC Resistance • FEP = Fluorinated Ethylene Propylene • HDPE = High-density Polyethylene • TC = Tinned Copper

Contact the Belden Customer Service Department for a Comprehensive Connector Cross Reference. 1-800-BELDEN-1. Request quotations of RG/U cables not listed.

†Final put-up length may vary ±10% for spools or reels, ±5% for Unreel cartons from length shown.



Precision Video Cable for Analog and Digital

RG-59/U Type



Description	Part No.	UL NEC/ C(UL) CEC Type	Standard Lengths		Standard Unit Weight		Conductor (stranding) Diameter Nom. DCR	Nominal Core OD		Shielding Materials Nom. DCR	Nominal OD		Nom. Imp. (Ω)	Nom. Vel. of Prop.	Nominal Capacitance		Nominal Attenuation		
			Ft.	m	Lbs.	kg		Inch	mm		Inch	mm			pF/Ft.	pF/m	MHz	dB/100 Ft.	dB/100m

20 AWG Solid .031" Bare Copper Conductor • Tinned Copper/Bare Copper Double Braid Shield (98% Coverage) (continued)

Polyethylene Insulation • Clear Polyethylene Jacket																			
Indoor Use 80°C	9141	—	1000	304.8	73.0	33.2	20 AWG (solid) .031"	.200	5.06	TC Double Braid 98% Shield Coverage	.305	7.75	75	66%	20.0	65.6	1	.3	1.0
							9.9Ω/M'			1.1Ω/M'							3.6	.5	1.6
							32.5Ω/km			3.6Ω/km							10.0	.8	2.6
																	71.5	2.0	6.6
																	135	3.5	11.5
																	270	4.3	14.1
																	360	5.0	16.4
																	540	6.2	20.3
																	720	7.2	23.6
																	750	7.4	24.3
																	1000	9.1	29.8

20 AWG Solid .031" Bare Copper Conductor • Tinned Copper/Bare Copper Double Braid Shield (98% Coverage)

Polyethylene Insulation • Polyethylene Jacket (Available in Red, Yellow, Green, Blue, White, Orange or Black)																			
80°C	8281	—	500 [▲]	152.4	37.5	17.8	20 AWG (solid) .031"	.198	5.03	TC Double Braid 98% Shield Coverage	.305	7.75	75	66%	21.0	68.9	1	.3	.8
			1000	304.8	74.0	33.6	9.9Ω/M'			1.1Ω/M'							3.6	.5	1.8
							32.5Ω/km			3.6Ω/km							10.0	.8	2.6
																	71.5	2.1	6.9
																	135	3.0	9.8
																	270	4.3	14.1
																	360	5.1	16.6
																	540	6.3	20.7
																	720	7.4	24.3
																	750	7.6	24.9
																	1000	9.2	30.2

[▲]500 ft. put-up not available in White.

Flame-retardant Semi-foam Polyethylene Insulation • PVC Jacket (Available in 9 colors)*																			
UL AWM Style 1354 (30V 80°C)	8281B	NEC: CMR CEC: CMG FT4	1000	304.8	84.0	38.1	20 AWG (solid) .031"	.198	5.03	TC Double Braid 98% Shield Coverage	.305	7.75	75	66%	21.0	68.9	1	.3	.8
							9.9Ω/M'			1.1Ω/M'							3.6	.5	1.8
							32.5Ω/km			3.6Ω/km							10.0	.8	2.6
																	71.5	2.1	6.9
																	135	3.0	9.8
																	270	4.4	14.4
																	360	5.1	16.6
																	540	6.6	21.5
																	720	7.8	25.4
																	750	8.0	26.2
																	1000	10.2	33.5

*8281B available in Red, Orange, Yellow, Green, Blue, Purple, Gray, White or Black.

22 AWG Stranded (7x29) .031" Bare Compacted Copper Conductor* • Tinned Copper/Bare Copper Double Braid Shield (98% Coverage)

Polyethylene Insulation • PVC Jacket (Matte Red, Blue, Green, Gray or Black)																			
High-Flex 60°C	8281F	—	500 [▲]	152.4	34.5	15.7	22 AWG (7x29) .031"	.193	4.90	TC Double Braid 98% Shield Coverage	.305	7.75	75	66%	21.0	68.9	1	.3	.9
			1000	304.8	67.0	30.4	12.2Ω/M'			1.7Ω/M'							3.6	.5	1.7
							40.0Ω/km			5.6Ω/km							10.0	.9	2.9
																	71.5	2.5	8.0
																	135	3.6	11.6
																	270	5.1	16.7
																	360	6.0	19.7
																	540	7.4	24.3
																	720	8.7	28.5
																	750	8.9	29.2
																	1000	10.5	34.4

*500 ft. put-up available in Black only.

20 AWG Solid .032" Bare Copper Conductor • Tinned Copper/Bare Copper Double Braid Shield (98% Coverage)

Plenum • FEP Insulation • Black Fluorocopolymer Jacket																			
150°C	88281	NEC: CMP CEC: CMP FT6	500	152.4	44.5	20.2	20 AWG (solid) .032"	.185	4.70	TC Double Braid 98% Shield Coverage	.271	6.88	75	71%	19.0	62.4	1	.2	.7
			1000	304.8	86.0	39.1	9.9Ω/M'			1.1Ω/M'							3.6	.5	1.6
							32.5Ω/km			3.6Ω/km							10.0	.8	2.6
																	71.5	2.3	7.5
																	135	3.3	10.8
																	270	5.1	16.7
																	360	6.1	20.0
																	540	8.0	26.2
																	720	9.7	31.8
																	750	10.0	32.8
																	1000	12.3	40.3

Suitable for Outdoor and Direct Burial applications.

BC = Bare Copper • BCC = Bare Compacted Copper • DCR = DC Resistance • FEP = Fluorinated Ethylene Propylene • HDPE = High-density Polyethylene • TC = Tinned Copper

Contact the Belden Customer Service Department for a Comprehensive Connector Cross Reference. 1-800-BELDEN-1. Request quotations of RG/U cables not listed.

*Compacted conductor combines impedance uniformity of solid conductors and "nick-resistance" of stranded conductor.



Precision Video Cable for Analog and Digital
RG-6/U and RG-11/U Type



Table with columns: Description, Part No., UL NEC/ C(UL) CEC Type, Standard Lengths (Ft, m), Standard Unit Weight (Lbs, kg), Conductor (stranding) Diameter Nom. DCR, Nominal Core OD (Inch, mm), Shielding Materials Nom. DCR, Nominal OD (Inch, mm), Nom. Imp. (Ω), Nom. Vel. of Prop., Nominal Capacitance (pF/Ft, pF/m), Nominal Attenuation (MHz, dB/100 Ft, dB/100m)

RG-6/U Type • 18 AWG Solid .040" Bare Copper Conductor • Duofoil® (100% Coverage) + Tinned Copper Braid Shield (95% Coverage)

Table for RG-6/U Type cable specifications, including Gas-injected Foam HDPE Insulation • PVC Jacket (Available in 10 colors)*. Includes part number 1694A and various electrical characteristics.

*500 ft. put-up available in Black only.

Gas-injected Foam HDPE Insulation • Black Low-Smoke, Zero-Halogen Jacket

Table for RG-6/U Type cable specifications, including Gas-injected Foam HDPE Insulation • Black Low-Smoke, Zero-Halogen Jacket. Includes part number 1694SB and various electrical characteristics.

Plenum • Foam FEP Insulation • Flammarrest® Jacket (Available in 10 colors)**

Table for RG-6/U Type cable specifications, including Plenum • Foam FEP Insulation • Flammarrest® Jacket. Includes part number 1695A and various electrical characteristics.

*500 ft. put-up available in Black or Natural only. Black jacket suitable for Indoor, Outdoor and Aerial applications.

RG-11/U Type • 14 AWG Solid .064" Bare Copper Conductor • Duofoil (100% Coverage) + Tinned Copper Braid Shield (95% Coverage)

Gas-injected Foam HDPE Insulation • PVC Jacket (Available in 10 colors)*

Table for RG-11/U Type cable specifications, including Gas-injected Foam HDPE Insulation • PVC Jacket. Includes part number 7731A and various electrical characteristics.

*500 ft. put-up available in Red or Black only.

Plenum • Foam FEP Insulation • Fluorocopolymer Jacket (Available in 10 colors)**

Table for RG-11/U Type cable specifications, including Plenum • Foam FEP Insulation • Fluorocopolymer Jacket. Includes part number 7732A and various electrical characteristics.

*500 ft. put-up available in Black or Natural only.

**2000 ft. put-up available in Natural only.

Suitable for Outdoor and Direct Burial applications.

BC = Bare Copper • DCR = DC Resistance • FEP = Fluorinated Ethylene Propylene • HDPE = High-density Polyethylene • TC = Tinned Copper

Contact the Belden Customer Service Department for a Comprehensive Connector Cross Reference. 1-800-BELDEN-1. Request quotations of RG-U cables not listed.

* Non-Plenum Available in Black, Brown, Red, Orange, Yellow, Green, Blue, Purple, Gray or White.

** Plenum Available in Black, Brown, Red, Orange, Yellow, Green, Blue, Purple, Gray or Natural.

† Final put-up length may vary ±10% for spools or reels and ±5% for Unreel cartons from length shown.

Brilliance VideoFLEX® Snake Cable for Precision Analog and Digital Video

Miniature and RG-59/U Type



Description	Part No.	UL NEC/ C(UL) CEC Type	No. of Cond.	Standard Lengths		Standard Unit Weight		Conductor (stranding) Diameter Nom. DCR	Nominal Core OD		Shielding Materials Nom. DCR	Nominal OD		Nom. Imp. (Ω)	Nom. Vel. of Prop.	Nominal Capacitance		Nominal Attenuation			
				Ft.	m	Lbs.	kg		Inch	mm		Inch	mm			pF/Ft.	pF/m	MHz	dB/ 100 Ft.	dB/ 100m	
Miniature • 23 AWG Solid .023" Bare Copper Conductors • Duofoil® (100% Coverage) + TC Braid Shield (95% Coverage)																					
Gas-injected Foam HDPE Insulation • Overall Matte Black PVC Jacket (Color Code: See chart below)																					
SDI/HDTV Digital Video 75°C (1855A Bundled)	7787A	NEC: CMR CEC: CMG FT4	3	500 1000	152.4 304.8	47.5 94.0	21.6 42.7	23 AWG (solid) .023" BC 20.1Ω/M' 65.9Ω/km	.102 Coax OD: .159	2.55 4.03	Duofoil + 95% TC Braid 7.6Ω/M' 24.9Ω/km	.432	10.97	75	83%	16.5	54.1	1 3.6 10 71.5 135 270 360 540 720 750 1000 1500 2500 3000	.4 8 1.2 3.1 3.8 5.4 6.2 7.7 9.1 9.5 10.5 13.0 16.9 18.5	1.3 2.6 3.9 10.0 12.5 17.7 20.3 25.3 29.8 31.2 34.4 42.6 55.4 60.7	
	7788A	NEC: CMR CEC: CMG FT4	4	1000	304.8	110.0	49.9	same as above	.102 Coax OD: .159	2.55 4.03	same as above	.481	12.22					750 1000 1500 2500 3000	9.5 10.5 13.0 16.9 18.5	31.2 34.4 42.6 55.4 60.7	
	7789A	NEC: CMR CEC: CMG FT4	5	500 1000	152.4 304.8	73.0 142.0	33.1 64.4	same as above	.102 Coax OD: .159	2.55 4.03	same as above	.539	13.69								
	7790A	NEC: CMR CEC: CMG FT4	6	500 1000	152.4 304.8	88.5 176.0	40.2 79.9	same as above	.102 Coax OD: .159	2.55 4.03	same as above	.597	15.16								
	7791A	NEC: CMR CEC: CMG FT4	10	500 1000	152.4 304.8	155.5 304.0	70.5 137.9	same as above	.102 Coax OD: .159	2.55 4.03	same as above	.796	20.22								
	7792A	NEC: CMR CEC: CMG FT4	12	500 1000	152.4 304.8	178.5 367.0	80.7 166.5	same as above	.102 Coax OD: .159	2.55 4.03	same as above	.825	20.96								

Sweep tested 5 MHz to 3 GHz.

RG-59/U Type • 23 AWG Solid .032" Bare Copper Conductors • Duofoil (100% Coverage) + TC Braid Shield (95% Coverage)

Gas-injected Foam HDPE Insulation • Overall Matte Black PVC Jacket (Color Code: See chart below)																					
SDI/HDTV Digital Video 75°C (1505A Bundled)	7794A	NEC: CMR CEC: CMG FT4	3	500 1000	152.4 304.8	94.5 187.0	43.0 84.8	23 AWG (solid) .032" BC 10.0Ω/M' 32.8Ω/km	.145 Coax OD: .235	3.68 5.97	Duofoil + 95% TC Braid 3.8Ω/M' 12.5Ω/km	.631	16.03	75	83%	16.3	53.1	1 3.6 10 71.5 135 270 360 540 720 750 1000 1500 2500 3000	.3 6 9 2.1 2.7 3.8 4.4 5.5 6.4 6.5 7.6 9.3 12.4 13.8	1.0 1.8 2.9 6.9 8.9 12.5 14.4 18.0 21.0 21.3 24.9 30.5 40.7 45.3	
	7795A	NEC: CMR CEC: CMG FT4	4	500 1000	152.4 304.8	116.5 237.0	53.0 107.7	same as above	.145 Coax OD: .235	3.68 5.97	same as above	.706	17.93								
	7796A	NEC: CMR CEC: CMG FT4	5	500 1000	152.4 304.8	153.0 299.0	69.4 135.6	same as above	.145 Coax OD: .235	3.68 5.97	same as above	.790	20.07								
	7798A	NEC: CMR CEC: CMG FT4	10	500 1000	152.4 304.8	319.5 625.0	145.2 284.1	same as above	.145 Coax OD: .235	3.68 5.97	same as above	1.166	29.62								

Sweep tested 5 MHz to 3 GHz.

BC = Bare Copper • DCR = DC Resistance • HDPE = High-density Polyethylene • TC = Tinned Copper

See Connector Reference Guide at www.belden.com for connector recommendations.

Color Code Chart

Cond.	Color	Cond.	Color	Cond.	Color
1	Red	5	Yellow	9	Purple
2	Green	6	Brown	10	Black
3	Blue	7	Orange	11	Pink
4	White	8	Gray	12	Tan



For more information, contact Belden Technical Support: 1-800-BELDEN-1 • www.belden.com

Brilliance VideoFLEX® Snake Cable for Precision Analog and Digital Video

RG-6/U Type



Description	Part No.	UL NEC/ C(UL) CEC Type	No. of Cond.	Standard Lengths		Standard Unit Weight		Conductor (stranding) Diameter Nom. DCR	Nominal Core OD		Shielding Materials Nom. DCR	Nominal OD		Nom. Imp. (Ω)	Nom. Vel. of Prop.	Nominal Capacitance		Nominal Attenuation		
				Ft.	m	Lbs.	kg		Inch	mm		Inch	mm			pF/Ft.	pF/m	MHz	dB/ 100 Ft.	dB/ 100m

RG-59/U • 20 AWG Solid .032" Bare Copper Conductors • Duofoil® (100% Coverage) + Tinned Copper Braid Shield (95% Coverage)

Plenum • Foam FEP Insulation • Plenum-Grade PVC Jackets (Color Code: See chart below) • **Center Spine • No Overall Jacket**

	300V RMS	1283S3 <small>new</small>	NEC: 3 CMP: 500 CEC: 1000 CMP	250 500 1000	76.2 152.4 304.8	26.3 54.0 103.0	11.9 24.5 46.7	20 AWG (solid) .032"	.133	3.38	Duofoil (95%) + TC Braid 3.8Ω/M' 12.5Ω/km	.422	10.72	75	83%	16.2	53.1	1	.3	1.0
								10.0Ω/M' 32.8Ω/km										3.6	.6	2.0
																		10	.9	2.9
																		71.5	2.1	6.9
																		135	2.7	8.9
																		270	3.8	12.5
																		360	4.4	14.4
																		540	5.5	18.0
																		720	6.4	21.0
																		750	6.5	21.3
																	1000	7.6	24.9	
																	1500	9.4	30.8	
																	2500	12.4	40.7	
																	3000	13.8	45.3	

Sweep tested. 5 MHz to 3 GHz.
U.S. Patent 7,049,523

Suitable for Indoor and Outdoor applications.

RG-6/U Type • 18 AWG Solid .040" Bare Copper Conductors • Duofoil® (100% Coverage) + Tinned Copper Braid Shield (95% Coverage)

Gas-injected Foam HDPE Insulation • Overall Matte Black PVC Jacket (Color Code: See chart below)

	SDI/HDTV Digital Video 75°C (1694A Bundled)	7710A	NEC: 3 CMR: 1000 CEC: CMG FT4	500 1000	152.4 304.8	137.5 285.0	62.4 129.3	18 AWG (solid) .040"	.180	4.57	Duofoil + 95% TC Braid 3.0Ω/M' 9.8Ω/km	.770	19.56	75	82%	16.2	53.1	1	.2	.8
								6.4Ω/M' 21.0Ω/km										3.6	.5	1.5
																		10	.7	2.4
																		71.5	1.6	5.2
																		135	2.1	6.9
																		270	3.0	9.7
																		360	3.4	11.3
																		540	4.3	13.9
																		720	4.9	16.1
																		750	5.0	16.4
																	1000	5.9	19.3	
																	1500	7.3	24.0	
																	2500	9.1	31.8	
																	3000	10.6	35.0	

Sweep tested 5 MHz to 3 GHz.

BC = Bare Copper • DCR = DC Resistance • FEP = Fluorinated Ethylene Propylene • HDPE = High-density Polyethylene • TC = Tinned Copper

Contact the Belden Customer Service Department for a Comprehensive Connector Cross Reference. **1-800-BELDEN-1**. Request quotations of RG/U cables not listed. See Connector Reference Guide at www.belden.com for connector recommendations.

Color Code Chart

Cond.	Color	Cond.	Color
1	Red	6	Brown
2	Green	7	Orange
3	Blue	8	Gray
4	White	9	Purple
5	Yellow	10	Black



Bundled RGB Cable

Miniature and High-Flex Type



Description	Part No.	UL NEC/ C(UL) CEC Type	No. of Cond.	Standard Lengths		Standard Unit Weight		Conductor (stranding) Diameter	Nominal Core OD		Shielding Materials Nom. DCR	Nominal OD		Nom. Imp. (Ω)	Nom. Vel. of Prop.	Nominal Capacitance		Nominal Attenuation	
				Ft.	m	Lbs.	kg		Inch	mm		Inch	mm			pF/Ft.	pF/m	MHz	dB/ 100 Ft.

Miniature • 30 AWG Stranded (7x38) .012" TC Cond. • Coaxes: Duofoil® (100% Coverage) + TC Braid (90% Cov.) • Overall: Beldfoil® Shield (100% Cov.)

Foam HDPE Insulation • Inner PVC Jackets (Color Code: See Chart Below) • Overall Black PVC Jacket

	UL AWM Style 1354 (30V 60°C)	1520A	NEC: CL2	3	500 1000	152.4 304.8	23.0 50.0	10.4 22.7	30 AWG (7x38) .012"	.056 .102	1.42 2.59	Coaxes: Duofoil + 90% TC Braid Overall: Beldfoil	.283 7.19	75	78%	17.3	56.7	1 5 10 30 50 100 200 400 700 900 1000	.8 1.5 2.2 4.0 5.4 8.2 12.5 18.9 26.5 30.8 32.8	2.6 4.9 7.2 13.1 17.7 26.9 41.0 62.0 86.9 101.0 107.6	
		1521A	NEC: CL2	4	500 1000	152.4 304.8	31.0 60.0	14.1 27.3	same as above	.056 .102	1.42 2.59	same as above	.310 7.87								
		1522A	NEC: CL2	5	500 1000	152.4 304.8	34.5 67.0	15.6 30.4	same as above	.056 .102	1.42 2.59	same as above	.338 8.59								

High-Flex • 26 AWG Stranded (7x34) .019" Bare Copper Conductors • Duofoil (100% Coverage) + TC Braid Shield (93% Coverage)

Foam HDPE Insulation • Inner PVC Jackets (Color Code: See Chart Below) • Overall Matte Black PVC Jacket

	60°C	1406B	—	3	1000	304.8	79.0	35.8	26 AWG (7x34) .019"	.090 .146	2.29 3.71	Duofoil + 93% TC Braid	.388 9.86	75	78%	17.3	56.7	1 5 10 30 50 100 200 400 700 900 1000	.6 1.3 1.8 3.1 3.9 5.4 7.5 10.4 13.5 15.2 15.9	2.0 4.3 5.9 10.2 12.8 17.7 24.6 34.1 44.3 49.9 52.2	
		1407B	—	4	1000	304.8	100.0	45.5	same as above	.090 .146	2.29 3.71	same as above	.455 11.56								
		1417B	—	5	1000	304.8	110.0	49.9	same as above	.090 .146	2.29 3.71	same as above	.477 12.12								

BC = Bare Copper • DCR = DC Resistance • HDPE = High-density Polyethylene • TC = Tinned Copper

Contact the Belden Customer Service Department for a Comprehensive Connector Cross Reference. **1-800-BELDEN-1**. Request quotations of cables not listed.

Color Code Chart

Cond.	Color
1	Red
2	Green
3	Blue
4	White
5	Yellow



Bundled RGB Cable

CM, CMR and CMP Rated



Description	Part No.	UL NEC/ C(UL) CEC Type	No. of Cond.	Standard Lengths		Standard Unit Weight		Conductor (stranding) Diameter Nom. DCR	Nominal Core OD		Shielding Materials Nom. DCR	Nominal OD		Nom. Imp. (Ω)	Nom. Vel. of Prop.	Nominal Capacitance		Nominal Attenuation		
				Ft.	m	Lbs.	kg		Inch	mm		Inch	mm			pF/Ft.	pF/m	MHz	dB/100 Ft.	dB/100m

26 AWG Stranded (7x34) .019" BC Conductor • Duofoil® (100% Coverage) + TC Braid Shield (93% Coverage) • Overall Polyester Tape

Foam HDPE Insulation • Inner PVC Jacket (Color Code: See Chart Below) • **Overall Black PVC Jacket**

	1164B UL AWM Styles 1354 and 2668 (30V 60°C)	NEC: 3 CM CEC: CM	500 1000	152.4 304.8	38.0 78.0	17.2 35.5	26 AWG (7x34) .019" BC 41.5Ω/M' 136.1Ω/km	.090 Coax OD: .146	2.29 3.71	Duofoil + 93% TC Braid 8.6Ω/M' 28.2Ω/km	.388 9.86	75 78%	17.3 56.7	1 5 10 30 50 100 200 400 700 900 1000	.6 1.3 1.8 3.1 3.9 5.4 7.5 10.4 13.5 15.2 15.9	2.0 4.3 5.9 10.2 12.8 17.7 24.6 34.1 44.3 49.9 52.2
		NEC: 4 CM CEC: CM	1000	304.8	105.0	47.7	same as above	.090 Coax OD: .146	2.29 3.71	same as above	.455 11.56				4 5	White Yellow
		NEC: 5 CM CEC: CM	500 1000	152.4 304.8	61.5 119.0	27.9 54.0	same as above	.090 Coax OD: .146	2.29 3.71	same as above	.477 12.12				3	Blue

Color Code Chart

Cond.	Color	Cond.	Color
1	Red	4	White
2	Green	5	Yellow
3	Blue		

25 AWG Solid .018" Tinned Copper Conductors • Duobond® (100% Coverage) + Tinned Copper Interlocked Serve Shield (95% Coverage)

FPFA Insulation • Inner PVC Jacket (Color Code: See chart below) • **Overall Black PVC Jacket**

	1277R 300V RMS 60°C new	NEC: 3 CMR CEC: CMG	500† 1000†	152.4 304.8	25.5 48.0	11.6 21.8	25 AWG (solid) .018" TC 34.0Ω/M' 111.6Ω/km	.074 Coax OD: .114	1.88 2.90	Duobond + 95% TC Braid 5.4Ω/M' 17.7Ω/km	.320 8.13	75 80%	17.0 55.8	1 5 50 100 200 400 750 900 1000 3000	.5 1.2 3.7 4.9 6.7 9.5 13.4 15.0 15.8 31.2	1.7 3.8 12.1 16.1 22.0 31.2 44.0 49.2 51.8 102.4
		NEC: 4 CMR CEC: CMG	250 500† 1000†	76.2 152.4 304.8	21.8 31.5 60.0	9.9 14.3 27.2	same as above	.074 Coax OD: .114	1.88 2.90	same as above	.351 8.92				4 5	White Yellow
		NEC: 5 CMR CEC: CMG	500† 1000†	152.4 304.8	40.5 80.0	18.4 36.3	same as above	.074 Coax OD: .114	1.88 2.90	same as above	.403 10.24				6	Black
		NEC: 6 CMR CEC: CMG	500† 1000†	152.4 304.8	44.0 87.0	20.0 39.5	same as above	.074 Coax OD: .114	1.88 2.90	same as above	.423 10.74				3	Blue

100% Sweep tested. 5 MHz to 850 MHz.
See page 6.34 for single coax versions.

Color Code Chart

Cond.	Color	Cond.	Color
1	Red	4	Yellow
2	Green	5	Black
3	Blue	6	White

Plenum • FPFA Insulation • Inner Fluorocopolymer Jacket (Color Code: See chart below) • **Overall Gray PVC Jacket**

	1277P 300V RMS 60°C new	NEC: 3 CMP CEC: CMP	500 1000	152.4 304.8	19.0 41.0	9.8 19.5	25 AWG (solid) .018" TC 34.0Ω/M' 11.6Ω/km	.074 Coax OD: .111	1.91 2.92	Duobond + 95% TC Braid 5.4Ω/km 17.7Ω/km	.276 7.01	75 81%	16.8 55.1	1 5 50 100 200 400 750 1000	.5 1.2 3.8 5.2 7.1 10.0 14.3 16.9	1.6 3.9 12.5 17.1 23.3 32.8 46.9 55.4
		NEC: 4 CMP CEC: CMP	500 1000	76.2 152.4	19.0 34.0	8.6 15.9	same as above	.074 Coax OD: .111	1.91 2.92	same as above	.304 7.72				4 5	Yellow Black
		NEC: 5 CMP CEC: CMP	250 500 1000	76.2 152.4 304.8	19.0 34.0 68.0	8.6 15.9 31.3	same as above	.074 Coax OD: .111	1.91 2.92	same as above	.335 8.51				6	White
		NEC: 6 CMP CEC: CMP	500 1000	152.4 304.8	39.0 79.0	17.7 35.9	same as above	.074 Coax OD: .111	1.91 2.92	same as above	.369 9.37				3	Blue

100% Sweep tested. 5 MHz to 850 MHz.
See page 6.34 for single coax versions.

Color Code Chart

Cond.	Color	Cond.	Color
1	Red	4	Yellow
2	Green	5	Black
3	Blue	6	White

BC = Bare Copper • DCR = DC Resistance • FPFA = Foam Perfluoroalkoxy • HDPE = High-density Polyethylene • TC = Tinned Copper

Contact the Belden Customer Service Department for a more Comprehensive Connector Cross Reference. **1-800-BELDEN-1**.

Request quotations of cables not listed.

†Spools are one piece, but length may vary ±10% from length shown.



For more information, contact **Belden Technical Support: 1-800-BELDEN-1 • www.belden.com**

Bundled RGB Cable

Banana Peel® Unjacketed Bundles Mini Hi-Res Component Video
CMR and CMP Rated



Description	Part No.	UL NEC/ C(UL) CEC Type	No. of Cond.	Standard Lengths		Standard Unit Weight		Conductor (stranding) Diameter Nom. DCR	Nominal Core OD		Shielding Materials Nom. DCR	Nominal OD		Nom. Imp. (Ω)	Nom. Vel. of Prop.	Nominal Capacitance		Nominal Attenuation		
				Ft.	m	Lbs.	kg		Inch	mm		Inch	mm			pF/Ft.	pF/m	MHz	dB/ 100 Ft.	dB/ 100m

Miniature • 25 AWG Solid .018" TC Conductors • Duobond® (100% Coverage) + TC Interlocked Serve Shield (95% Coverage)

Gas-injected Foam HDPE Insulation • PVC Jackets (Color Code: See chart below) • Center Spine • No Overall Jacket

	1281S3 <small>new</small>	NEC: CMR CEC: CMG	3	500 [†] 1000 [†]	152.4 304.8	17.0 31.0	7.7 14.1	25 AWG (solid) .018" TC 34.0Ω/M' 111.6Ω/km	.074	1.88	Duobond (100%) + TC Serve (95%) 5.4Ω/M' 17.7Ω/km	Single: .114 2.90 Overall: .246 6.25	75	80%	17.0	55.8	1 5 50 100 200 400 750 900 1000 3000	.52 1.2 3.7 4.9 6.7 9.5 13.4 15.0 15.8 31.2	1.7 3.8 12.1 16.1 22.0 31.2 44.0 49.2 51.8 102.4	
	1281S4 <small>new</small>	NEC: CMR CEC: CMG	4	500 [†] 1000 [†]	152.4 304.8	23.5 44.0	10.7 20.0	same as above	.074	1.88	same as above	Single: .114 2.90 Overall: .275 6.99								
	1281S5 <small>new</small>	NEC: CMR CEC: CMG	5*	250 [†] 500 [†] 1000 [†]	76.2 152.4 304.8	16.0 28.5 55.0	7.3 12.9 25.0	same as above	.074	1.88	same as above	Single: .114 2.90 Overall: .308 7.82								
	1281S6 <small>new</small>	NEC: CMR CEC: CMG FT4	6*	500 [†] 1000 [†]	152.4 304.8	33.5 68.0	15.2 30.8	same as above	.074	1.88	same as above	Single: .114 2.90 Overall: .342 8.69								
	100% Sweep tested. 5 MHz to 850 MHz. Guaranteed Return Loss -20db max. U.S. Patent 7,049,523																			

Plenum • FPFA • Flamarrest® Jackets (Color Code: See chart below) • Center Spine • No Overall Jacket

	1282S3 <small>new</small>	NEC: CMP CEC: CMP	3	500 1000	152.4 304.8	18.5 34.0	8.4 15.4	25 AWG (solid) .018" TC 34.0Ω/M' 111.6Ω/km	.075	1.91	Duobond (100%) + TC Serve (95%) 5.4Ω/M' 17.7Ω/km	Single: .114 2.90 Overall: .246 6.25	75	81%	16.8	55.1	1 5 50 100 200 400 750 1000 2250 3000	.50 1.2 3.8 5.2 7.1 10.0 14.3 16.9 25.5 33.9	1.6 3.9 12.1 17.1 23.1 32.9 47.0 55.4 83.6 111.3	
	1282S4 <small>new</small>	NEC: CMP CEC: CMP	4	500 1000	152.4 304.8	25.5 49.0	11.6 22.2	same as above	.075	1.91	same as above	Single: .114 2.90 Overall: .275 6.99								
	1282S5 <small>new</small>	NEC: CMP CEC: CMP	5*	250 500 1000	76.2 152.4 304.8	18.0 33.0 67.0	8.2 15.0 30.4	same as above	.075	1.91	same as above	Single: .114 2.90 Overall: .308 7.82								
	1282S6 <small>new</small>	NEC: CMP CEC: CMP	6*	500 1000	152.4 304.8	39.5 80.0	17.9 36.3	same as above	.075	1.91	same as above	Single: .114 2.90 Overall: .342 8.69								
	100% Sweep tested. 5 MHz to 850 MHz. Guaranteed Return Loss -20db max. U.S. Patent 7,049,523																			

DCR = DC Resistance • FPFA = Foam Perfluoroalkoxy • HDPE = High-density Polyethylene • TC = Tinned Copper

Contact the Belden Customer Service Department for a more Comprehensive Connector Cross Reference. **1-800-BELDEN-1**. Request quotations of cables not listed.

[†]Spools are one piece, but length may vary ±10% from length shown.

*Also available with all Black jackets.

Color Code Chart:

Cond.	Color	Cond.	Color
1	Red	4	Yellow
2	Green	5	Black
3	Blue	6	White



For more information, contact Belden Technical Support: **1-800-BELDEN-1** • www.belden.com

High-Flex S-Video Cable



Description	Part No.	UL NEC/ C(UL) CEC Type	No. of Cond.	Standard Lengths		Standard Unit Weight		Conductor (stranding) Diameter Nom. DCR	Nominal Core OD		Shielding Materials Nom. DCR	Nominal OD		Nom. Imp. (Ω)	Nom. Vel. of Prop.	Nominal Capacitance		Nominal Attenuation	
				Ft.	m	Lbs.	kg		Inch	mm		Inch	mm			pF/Ft.	pF/m	MHz	dB/ 100 Ft.

30 AWG Stranded (7x38) .012" Tinned Copper Conductors • Tinned Copper Serve Shield (90% Coverage)

Foam HDPE Insulation • Matte Black PVC Jacket (One Coax Printed and Striped for Identification)

	Parallel Zip Construction	1807A	—	2	U-500	U-152.4	8.0	3.6	30 AWG (7x38)	.058	1.47	TC Serve	.110	2.79	75	78%	17.3	56.7	1	.6	2.0
					500	152.4	7.5	3.4				90% Shield	x	x					5	1.4	4.6
					U-1000	U-304.8	15.0	6.8	.012"			Coverage	.230	5.84					10	2.1	6.9
					1000	304.8	14.0	6.4	TC			7.5Ω/M'							30	3.8	12.5
									100.0Ω/M'			24.6Ω/km							50	5.1	16.7
									328.0Ω/km										100	7.6	24.9
																			200	11.3	37.1
																			400	16.9	55.4
																			700	23.3	76.4
																			900	26.9	88.2
																		1000	28.6	93.8	

For Plenum version see 7700A.

Foam HDPE Insulation • Matte Black PVC Jacket (Inner PVC Jackets Color Code: Black and Yellow)

	Round Construction	1808A	—	2	U-500	U-152.4	16.5	7.5	30 AWG (7x38)	.058	1.47	TC Serve	.255	.84	75	78%	17.3	56.7	1	.6	2.0
					500	152.4	14.5	6.6				90% Shield							5	1.4	4.6
					U-1000	U-304.8	31.0	14.1	.013"	.100	2.54	Coverage							10	2.1	6.9
					1000	304.8	33.0	15.0	TC			7.5Ω/M'							30	3.8	12.5
									100.0Ω/M'			24.6Ω/km							50	5.1	16.7
									328.0Ω/km										100	7.6	24.9
																			200	11.3	37.1
																			400	16.9	55.4
																			700	23.3	76.4
																			900	26.9	88.3
																		1000	28.6	93.8	

Available in Plenum versions by special order only.

30 AWG Stranded (7x38) .012" Tinned Copper Conductors • Tinned Copper "French Braid" Shield (98% Coverage)

Plenum • Foam FEP Teflon® Insulation • Black Flamarrest® Jacket (One Coax Printed and Striped for Identification)

	Parallel Zip Construction	7700A	NEC: 2	500	152.4	8.5	3.9	30 AWG (7x38)	.053	1.35	TC	.107	2.72	75	78%	17.3	56.7	1	.7	2.3	
			CMP	1000	304.8	17.0	7.7				"French Braid"	x	x					5	1.7	5.6	
			CEC: CMP FT6						.012"			98% Shield	.214	5.44					10	2.3	7.5
									TC			Coverage							30	4.1	13.5
									100.0Ω/M'			7.5Ω/M'							50	5.3	17.4
									328.0Ω/km			24.6Ω/km							100	7.6	24.9
																			200	11.8	38.7
																			400	17.6	57.7
																			700	24.2	79.4
																			900	28.0	91.9
																		1000	29.8	97.8	

For Non-Plenum version see 1807A.

DCR = DC Resistance • FEP = Fluorinated Ethylene Propylene • HDPE = High-density Polyethylene • TC = Tinned Copper

Contact the Belden Customer Service Department for a more Comprehensive Connector Cross Reference. **1-800-BELDEN-1**. Request quotations of cables not listed.

Teflon is a DuPont trademark.



For more information, contact Belden Technical Support: **1-800-BELDEN-1** • www.belden.com

Video Triax Cable

RG-59/U Type



Description	Part No.	UL NEC/ C(UL) CEC Type	Standard Lengths		Standard Unit Weight		Conductor (stranding) Diameter Nom. DCR	Nominal Core OD		Shielding Materials Nom. DCR	Nominal OD		Nom. Imp. (Ω)	Nom. Vel. of Prop.	Nominal Capacitance		Nominal Attenuation		
			Ft.	m	Lbs.	kg		Inch	mm		Inch	mm			pF/Ft.	pF/m	MHz	dB/ 100 Ft.	dB/ 100m

22 AWG Stranded (19x34) .031" Bare Copper Conductor • Double Bare Copper Braid Shield (95% Coverage)

Foam Polyethylene Insulation • Belflex® Jacket (Red, Yellow, Green, Blue, Purple or Black. Polyethylene Insulation between Braids)

High-Flex 75°C	1857A	—	500	152.4	42.5	19.3	22 AWG (19x34) .031" BC 14.0Ω/M' 45.9Ω/km	.143	3.63	(2) BC Braids 95% Coverage Inner: 2.5Ω/M' 8.2Ω/km Outer: 1.6Ω/M' 5.3Ω/km	.360	9.14	75	79%	17.0	55.8	1	.3	1.0																							
			1000	304.8	86.0	39.1											3.6	.5	1.6	10	.8	2.6	71.5	2.2	7.2	135	3.1	10.2	270	4.5	14.8	360	5.4	17.7	540	6.8	22.3	720	8.1	26.6	750	8.4

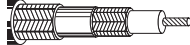

Suitable for Outdoor applications: Black for permanent installations, All colors for field deployable use.

20 AWG Solid .032" Bare Copper Conductor • Bare Copper Double Braid Shield (95% Coverage)

Plenum • Foam FEP Insulation • Black FEP Jacket (FEP Insulation between Braids)

200°C 75°C	88232	NEC: CMP CEC: CMP FT6	500	152.4	29.0	13.2	20 AWG (solid) .032" BC 10.0Ω/M' 32.8Ω/km	.140	3.56	(2) BC Braids 95% Coverage Inner: BC 2.6Ω/M' 8.5Ω/km Outer: 2.6Ω/M' 8.5Ω/km	.245	6.22	75	80%	16.9	55.4	1	.4	1.3																							
			1000	304.8	61.0	27.7											3.6	.6	2.0	10	.8	2.6	71.5	2.2	7.2	135	3.1	10.2	270	4.5	14.8	360	5.3	17.4	540	6.6	21.7	720	7.7	25.3	750	7.9

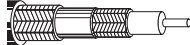

20 AWG Solid .032" Bare Copper Conductor • Bare Copper Double Braid Shield (80% Coverage)

Gas-injected Foam HDPE Insulation • Black Polyethylene Jacket (Polyethylene Insulation between Braids)

80°C	8232	—	500	152.4	31.0	14.1	20 AWG (solid) .032" BC 10.0Ω/M' 32.8Ω/km	.145	3.68	(2) BC Braids 80% Coverage Inner: BC 2.5Ω/M' 8.2Ω/km Outer: 2.8Ω/M' 9.2Ω/km	.315	8.00	75	83%	16.2	53.1	1	.3	1.0																							
			1000	304.8	60.0	27.3											3.6	.6	2.0	10	.9	3.0	71.5	2.1	6.9	135	3.0	9.8	270	4.2	13.8	360	4.8	15.7	540	5.9	19.4	720	7.0	23.0	750	7.1

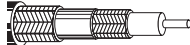

Suitable for Outdoor and Direct Burial applications. Suitable for Aerial applications when supported by a Messenger wire.

Gas-injected Foam HDPE Insulation • Black PVC Jacket (PVC Insulation between Braids)

75°C	8232A	NEC: CMR CEC: CMG FT4	1000	304.8	68.0	30.8	20 AWG (solid) .032" BC 10.0Ω/M' 32.8Ω/km	.145	3.68	(2) BC Braids 80% Coverage Inner: BC 2.5Ω/M' 8.2Ω/km Outer: 2.8Ω/M' 9.2Ω/km	.315	8.00	75	83%	16.2	53.1	1	.3	1.0																			
			3.6	.6	2.0	10											.9	3.0	71.5	2.1	6.9	135	3.0	9.8	270	4.2	13.8	360	4.8	15.7	540	5.9	19.4	720	7.0	23.0	750	7.1

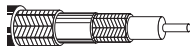

Suitable for Aerial applications when supported by a Messenger wire and for Outdoor Applications.

BC = Bare Copper • DCR = DC Resistance • FEP = Fluorinated Ethylene Propylene • HDPE = High-density Polyethylene

Contact the Belden Customer Service Department for a Comprehensive Connector Cross Reference. **1-800-BELDEN-1**. Request quotations of cables not listed.

Video Triax Cable

RG-59/U Type



Description	Part No.	UL NEC/ C(UL) CEC Type	Standard Lengths		Standard Unit Weight		Conductor (stranding) Diameter Nom. DCR	Nominal Core OD		Shielding Materials Nom. DCR	Nominal OD		Nom. Imp. (Ω)	Nom. Vel. of Prop.	Nominal Capacitance		Nominal Attenuation		
			Ft.	m	Lbs.	kg		Inch	mm		Inch	mm			pF/Ft.	pF/m	MHz	dB/100 Ft.	dB/100m

20 AWG Solid .032" Bare Copper Conductor • Double Bare Copper Braid Shield (95% Coverage)

Gas-injected Foam HDPE Insulation • Belflex® Jacket (Red, Yellow, Green, Blue or Black); Polyethylene Insulation between Braids

75°C	1856A	—	1000	304.8	83.0	37.7	20 AWG (solid)	.145	3.68	(2) BC Braids	.360	9.14	75	83%	16.2	53.1	1	.3	1.0
							.032"			95% Coverage							3.6	.6	2.0
							BC			Inner:							10	.8	2.6
							10.1Ω/M'			2.5Ω/M'							71.5	2.2	7.2
							33.1Ω/km			8.2Ω/km							135	3.0	9.8
										Outer:							270	4.2	13.8
										1.6Ω/M'							360	4.8	15.7
										5.3Ω/km							540	5.9	19.4
																	720	6.9	22.6
																	750	7.1	23.3
																	1000	8.8	28.9
																	1500	12.0	39.4
																	2250	16.4	53.8
																	3000	20.4	66.9

Suitable for Outdoor applications: Black for permanent installations, all colors for field deployable use.

Gas-injected Foam HDPE Insulation • Belflex Jacket (Red, Yellow, Green, Blue, Purple or Black); PVC Insulation between Braids

75°C	1856B	NEC: CMR CEC: CMG FT4	1000	304.8	86.0	39.1	20 AWG (solid)	.145	3.68	(2) BC Braids	.360	9.14	75	83%	16.2	53.1	1	.3	1.0
							.032"			95% Coverage							3.6	.6	2.0
							BC			Inner:							10	.8	2.6
							10.1Ω/M'			2.5Ω/M'							71.5	2.2	7.2
							33.1Ω/km			8.2Ω/km							135	3.0	9.8
										Outer:							270	4.2	13.8
										1.6Ω/M'							360	4.8	15.7
										5.2Ω/km							540	5.9	19.4
																	720	6.9	22.6
																	750	7.1	23.3
																	1000	8.8	28.9
																	1500	12.0	39.4
																	2250	16.4	53.8
																	3000	20.4	66.9

Suitable for Indoor/Outdoor applications.

Gas-injected Foam HDPE Insulation • Paper Tape Separator • Black Hypalon® Jacket (Polyethylene Insulation between Braids)

80°C	9267	—	500	152.4	39.5	18.0	20 AWG (solid)	.145	3.68	(2) BC Braids	.360	9.14	75	82%	16.3	53.5	1	.3	1.0
VW-1			1000	304.8	77.0	35.0	.032"			95% Coverage							3.6	.6	2.0
							BC			Inner:							10	.9	3.0
							10.0Ω/M'			2.5Ω/M'							71.5	2.1	6.9
							33.1Ω/km			8.2Ω/km							135	2.9	9.5
										Outer:							270	4.2	13.8
										2.6Ω/M'							360	4.8	15.7
										8.5Ω/km							540	6.0	19.7
																	720	6.7	22.0
																	750	6.9	22.6
																	1000	8.3	27.2
																	1500	10.5	34.5
																	2250	13.4	44.0
																	3000	15.9	52.2

Suitable for Outdoor and Direct Burial applications and Aerial when supported by a Messenger wire.

BC = Bare Copper • DCR = DC Resistance • HDPE = High-density Polyethylene

Contact the Belden Customer Service Department for a Comprehensive Connector Cross Reference. **1-800-BELDEN-1**. Request quotations of cables not listed.

Hypalon is a DuPont trademark.



For more information, contact **Belden Technical Support: 1-800-BELDEN-1 • www.belden.com**

Video Triax Cable

RG-11/U Type

75 Ohms



Description	Part No.	UL NEC/ C(UL) CEC Type	Standard Lengths		Standard Unit Weight		Conductor (stranding) Diameter Nom. DCR	Nominal Core OD		Shielding Materials Nom. DCR	Nominal OD		Nom. Imp. (Ω)	Nom. Vel. of Prop.	Nominal Capacitance		Nominal Attenuation		
			Ft.	m	Lbs.	kg		Inch	mm		Inch	mm			pF/Ft.	pF/m	MHz	dB/100 Ft.	dB/100m

15 AWG Stranded (19x27) .064" Bare Copper Conductor • Double Bare Copper Braid Shield (95% Coverage)

Gas-injected Foam HDPE Insulation • Belflex® Jacket (Red, Yellow, Green, Blue, Purple or Black) Polyethylene Insulation between Braids

	High-Flex 1858A	—	500	152.4	80.5	36.8	15 AWG (19x27) .064" BC 3.1Ω/M' 10.2Ω/km	.312	7.92	(2) BC Braids 95% Coverage Inner: 1.8Ω/M' 5.9Ω/km Outer: 1.4Ω/M' 4.6Ω/km	.520	13.20	75	78%	17.3	56.8	1	.1	.5
			1000	304.8	157.0	71.8											3.6	.3	1.0
																	10	.5	1.6
																	71.5	1.2	3.9
																	135	1.8	5.9
																	270	2.6	8.5
																	360	3.1	10.2
																	540	3.9	12.8
																	720	4.7	15.4
																	1000	5.7	18.7

Suitable for Outdoor applications: Black for permanent installations, all colors for field deployable use.

Plenum • Foam FEP Teflon® Insulation • Black Fluorocopolymer Jacket (Fluorocopolymer Insulation between Braids)

	1859A	NEC: CMP CEC: CMP FT6	500	152.4	66.5	30.2	15 AWG (19x27) .064" BC 3.1Ω/M' 10.2Ω/km	.285	7.24	(2) BC Braids 95% Coverage Inner: 1.4Ω/M' 4.6Ω/km Outer: 1.4Ω/M' 4.6Ω/km	.406	10.30	75	80%	16.5	54.1	1	.1	.3
			1000	304.8	134.0	60.9											3.6	.2	.7
																	10	.5	1.6
																	71.5	1.3	4.3
																	135	1.9	6.2
																	270	3.0	9.8
																	360	3.6	11.8
																	540	4.5	14.8
																	720	5.4	17.7
																	1000	6.6	21.7

Suitable for Outdoor and Direct Burial applications and Aerial when supported by a Messenger wire.

15 AWG Stranded (19x27) .064" Bare Copper Conductor • Double Bare Copper Braid Shield (90% Coverage)

Gas-injected Foam HDPE Insulation • Yellow PVC Jacket (Polyethylene Insulation between Braids)

	9192	NEC: CL2X	500	152.4	150.0	68.2	15 AWG (19x27) .064" BC 3.1Ω/M' 10.2Ω/km	.312	7.92	(2) BC Braids 90% Coverage Inner: 1.6Ω/M' 5.3Ω/km Outer: 1.6Ω/M' 5.3Ω/km	.520	13.20	75	78%	17.3	56.8	1	.1	.5
			1000	304.8	150.0	68.2											3.6	.3	1.0
																	10	.5	1.6
																	71.5	1.2	3.9
																	135	1.8	5.9
																	270	2.6	8.5
																	360	3.1	10.2
																	540	3.9	12.8
																	720	4.7	15.4
																	1000	5.7	18.7

Suitable for Outdoor applications: Black for permanent installations, all colors for field deployable use.

Gas-injected Foam HDPE Insulation • Paper Tape Separator • Black Hypalon® Jacket (Polyethylene Insulation between Braids)

	9232	—	500	152.4	76.5	19.3	15 AWG (19x27) .064" BC 3.1Ω/M' 10.2Ω/km	.312	7.92	(2) BC Braids 90% Coverage Inner: 1.6Ω/M' 5.3Ω/km Outer: 1.7Ω/M' 5.3Ω/km	.520	13.20	75	78%	17.3	56.8	1	.1	.5
			1000	304.8	145.0	65.9											3.6	.3	1.0
																	10	.5	1.6
																	71.5	1.2	3.9
																	135	1.8	5.9
																	270	2.6	8.5
																	360	3.1	10.2
																	540	3.9	12.8
																	720	4.7	15.4
																	1000	5.7	18.7

Suitable for Outdoor and Direct Burial applications.

BC = Bare Copper • DCR = DC Resistance • FEP = Fluorinated Ethylene Propylene • HDPE = High-density Polyethylene

Contact the Belden Customer Service Department for a Comprehensive Connector Cross Reference. **1-800-BELDEN-1**. Request quotations of cables not listed.

Teflon is a DuPont trademark.
Hypalon is a DuPont trademark.



For more information, contact Belden Technical Support: **1-800-BELDEN-1** • www.belden.com

Video Triax Cable

RG-11/U Type



Description	Part No.	UL NEC/ C(UL) CEC Type	Standard Lengths		Standard Unit Weight		Conductor (stranding) Diameter Nom. DCR	Nominal Core OD		Shielding Materials Nom. DCR	Nominal OD		Nom. Imp. (Ω)	Nom. Vel. of Prop.	Nominal Capacitance		Nominal Attenuation		
			Ft.	m	Lbs.	kg		Inch	mm		Inch	mm			pF/Ft.	pF/m	MHz	dB/100 Ft.	dB/100m

14 AWG Solid .064" Bare Copper Conductor • Double Bare Copper Braid Shield (95% Coverage)

Gas-injected Foam HDPE Insulation • Black Polyethylene Jacket (Polyethylene Insulation between Braids)

80°C	8233	—	500	152.4	63.0	28.6	14 AWG (solid)	.285	7.24	(2) BC Braids 95% Coverage	.475	12.07	75	84%	16.1	52.8	1	.2	.7
			1000	304.8	122.0	55.5											3.6	.3	1.0
			2000	609.6	240.0	109.1	.064"			Inner:							10	.4	1.3
							BC			Outer:							71.5	1.1	3.6
							2.5Ω/M'			1.6Ω/M'							135	1.5	4.9
							8.2Ω/km			5.3Ω/km							270	2.3	7.5
										1.4Ω/M'							360	2.7	8.9
										4.6Ω/km							540	3.5	11.5
																	720	4.2	13.8
																	750	4.3	14.1
																	1000	5.2	17.1
																	1500	7.1	23.3
																	2250	9.6	31.5
																	3000	12.0	39.4

Suitable for Outdoor and Direct Burial applications and Aerial when supported by a Messenger wire.

Gas-injected Foam HDPE Insulation • Black PVC Jacket (PVC Insulation between Braids)

75°C	8233A	NEC: —	1000	304.8	136.0	61.7	14 AWG (solid)	.285	7.24	(2) BC Braids 95% Coverage	.475	12.07	75	84%	16.1	52.8	1	.2	.7
		CMR	2000	609.6	266.0	120.7											3.6	.3	1.0
		CEC: CMG FT4	4000†	1219.2	572.0	259.5	.064"			Inner:							10	.4	1.3
							BC			Outer:							71.5	1.1	3.6
							2.5Ω/M'			1.6Ω/M'							135	1.5	4.9
							8.2Ω/km			5.3Ω/km							270	2.3	7.5
										1.4Ω/M'							360	2.7	8.9
										4.6Ω/km							540	3.5	11.5
																	720	4.2	13.8
																	750	4.3	14.1
																	1000	5.2	17.1
																	1500	7.1	23.3
																	2250	9.6	31.5
																	3000	12.0	39.4

Suitable for Aerial applications when supported by a Messenger wire and for Outdoor applications.

Gas-injected Foam HDPE Insulation • Black Polyethylene Jacket (PE Insulation between Braids; Flooding Compound on Outer Braid)

Flooded	7803A	—	500	152.4	64.0	29.1	14 AWG (solid)	.285	7.24	(2) BC Braids 95% Coverage	.475	12.07	75	84%	16.1	52.8	1	.2	.7
80°C			1000	304.8	123.0	55.9											3.6	.3	1.0
			3000	914.4	381.0	173.2	.064"			Inner:							10	.4	1.3
							BC			Outer:							71.5	1.1	3.6
							2.5Ω/M'			1.6Ω/M'							135	1.5	4.9
							8.2Ω/km			5.2Ω/km							270	2.3	7.5
										1.4Ω/M'							360	2.7	8.9
										4.6Ω/km							540	3.5	11.5
																	720	4.2	13.8
																	750	4.3	14.1
																	1000	5.2	17.1
																	1500	7.1	23.3
																	2250	9.6	31.5
																	3000	12.0	39.4

Suitable for Outdoor and Direct Burial applications and Aerial applications when supported by a Messenger wire.

BC = Bare Copper • DCR = DC Resistance • HDPE = High-density Polyethylene • PE = Polyethylene

Contact the Belden Customer Service Department for a Comprehensive Connector Cross Reference. **1-800-BELDEN-1**. Request quotations of cables not listed.

†Final put-up may vary ±10% from length shown.



DS-3 and DS-4 Interconnect and Cross-connect Cable

735A* Series

Description	Part No.	UL NEC/ C(UL) CEC Type	No. of Cond.	Standard Lengths		Standard Unit Weight		Conductor (stranding) Diameter Nom. DCR	Nominal Core OD		Shielding Materials Nom. DCR	Nominal OD		Nom. Imp. (Ω)	Nom. Vel. of Prop.	Nominal Capacitance		Nominal Attenuation		
				Ft.	m	Lbs.	kg		Inch	mm		Inch	mm			Stand. Signal (Mb/s)	MHz	dB/100 Ft.	dB/100m	

26 AWG Solid .016" (.40mm) Silver-plated Copper Conductor(s) • Beldfoil® + Tinned Copper Braid Shield (93% Coverage)

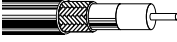
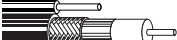
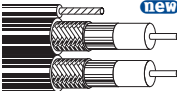
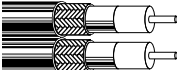
Foam HDPE Insulation • Overall Gray PVC Jacket (Multiple coaxes feature inner Gray PVC jackets w/printed nos. for circuit ID)

	735A1	NEC: CMR CEC: CMG FT4	1	500 1000	152.4 304.8	6.5 12.0	2.9 5.5	26 AWG (solid) .016" SPC 41.0Ω/M' 134.5Ω/km	.077	1.96	Beldfoil + 93% TC Braid 5.3Ω/M' 17.4Ω/km	.129	3.38	75	76%	17.7	58.0	2	1.0	.6	2.0	
	For Plenum version see 735A1P.																					
		CEPT-1	1.0	.6	2.0																	
	CEPT-2	4.2	1.1	3.6																		
	10	5.0	1.2	3.9																		
	20	10.0	1.7	5.6																		
	CEPT-3	17.2	2.2	7.2																		
	DS-3	22.4	2.5	8.2																		
	STS-1	25.9	2.7	8.9																		
	89.472	44.7	3.6	11.8																		
	100	50.0	3.8	12.5																		
	CEPT-4	69.6	4.5	14.8																		
	STS-3	77.8	4.8	15.7																		
	200	100.0	5.5	18.0																		
	DS-4	137.1	6.4	21.0																		
	400	200.0	7.8	25.6																		
	735A1T	NEC: CMR CEC: CMG FT4	1	500 1000	152.4 304.8	7.5 13.0	3.4 6.0	same as above	.077	1.96	same as above	.129	3.28									
	PVC insulated tracer.																					
	73502T <i>new</i>	NEC: CMR CEC: CMG	2	500 1000	152.4 304.8	20.0 44.0	9.1 20.0	26 AWG (solid) .017" SPC 41.0Ω/M' 134.5Ω/km	.077	1.96	same as above	.179	4.55									
	22 AWG stranded (7x30) tinned copper PVC insulated tracer.																					
	735A2	NEC: CMR CEC: CMG FT4	2	500† 1000†	152.4 304.8	14.0 26.0	6.4 11.8	26 AWG (solid) .016" SPC 41.0Ω/M' 134.5Ω/km	.077	1.96	same as above	.129	3.28									
	Siamese versions bonded in parallel, feature zip cord design with printing on one leg. Suitable for Outdoor applications.																					
	735A3	NEC: CMR CEC: CMG FT4	3	500† 1000†	152.4 304.8	27.0 52.0	12.0 23.6	same as above	.077	1.96	same as above Coax OD: .129 3.28	.309	7.85									
	735A6	NEC: CMR CEC: CMG FT4	6	500 1000	152.4 304.8	47.0 95.0	21.3 43.1	same as above	.077	1.96	same as above Coax OD: .129 3.28	.399	10.14									
	735A8	NEC: CMR CEC: CMG FT4	8	500† 1000	152.4 304.8	64.5 125.0	29.3 56.7	same as above	.077	1.96	same as above Coax OD: .129 3.28	.447	11.35									
	735A9	NEC: CMR CEC: CMG FT4	9	500† 1000†	152.4 304.8	77.0 133.0	34.9 60.5	same as above	.077	1.96	same as above Coax OD: .129 3.28	.484	12.29									
	735A12	NEC: CMR CEC: CMG FT4	12	500 1000	152.4 304.8	94.5 187.0	43.0 85.0	same as above	.077	1.96	same as above Coax OD: .129 3.28	.581	14.76									
	735A16	NEC: CMR CEC: CMG FT4	16	500 1000	152.4 304.8	126.5 257.0	57.4 116.6	same as above	.077	1.96	same as above Coax OD: .129 3.28	.636	16.15									
	735A24	NEC: CMR CEC: CMG FT4	24	1000†	304.8	416.0	188.7	same as above	.077	1.96	same as above Coax OD: .129 3.28	.870	22.10									

Siamese versions bonded in parallel, feature zip cord design with printing on one leg. Suitable for Outdoor applications.

100% Sweep tested.
RL: 30dB min. at 15 MHz to 95 MHz.
Non-plenum versions comply with Telcordia Specification GR-139-CORE.

Plenum • Foam FEP Insulation • Gray Flammarrest® Jacket

	735A1P	NEC: CMP CEC: CMP FT6	1	500 1000	152.4 304.8	7.5 14.0	3.4 6.4	same as above	.077	1.96	same as above	.129	3.28	75	76%	17.7	58.1	(same as above)			
	100% Sweep tested. RL: 30 dB min. at 15 MHz to 95 MHz.																				

DCR = DC Resistance • FEP = Fluorinated Ethylene Propylene • HDPE = High-density Polyethylene • SPC = Silver-plated Copper • TC = Tinned Copper
See chart on page 6.58 for maximum transmission distances.

*Lucent Technologies reference specification. Belden equivalent. Minimum Return Loss @ 55 MHz to 95 MHz = -35dB.
†Final put-ups may vary ±10% from length shown for spools or reels and ±5% for UnReel® cartons.

DS-3 and DS-4 Interconnect and Cross-connect Cable

734A* Series

Description	Part No.	UL NEC/ C(UL) CEC Type	No. of Cond.	Standard Lengths		Standard Unit Weight		Conductor (stranding) Diameter Nom. DCR	Nominal Core OD		Shielding Materials Nom. DCR	Nominal OD		Nom. Imp. (Ω)	Nom. Vel. of Prop.	Nominal Capacitance		Nominal Attenuation		
				Ft.	m	Lbs.	kg		Inch	mm		Inch	mm			pF/Ft.	pF/m	Stand. Signal (Mb/s)	MHz	dB/ 100 Ft.

20 AWG Solid .032" (.81mm) Bare Copper Conductor(s) • Beldfoil® (100% Coverage) + Tinned Copper Braid Shield (85% Coverage)

Gas-injected FHDPE Insulation • Overall Gray PVC Jacket (Multiple coaxes feature inner Gray PVC jackets w/printed nos. for circuit ID)

	734A1	NEC: CMR CEC: CMG FT4	1	500 1000	152.4 304.8	16.0 35.0	7.3 15.9	20 AWG (solid) .032" BC 10.0Ω/M' 32.8Ω/km	.148 3.76	Beldfoil + 85% TC Braid 2.4Ω/M' 7.9Ω/km	.235 5.97	75	80%	16.8	55.1	2	CEPT-1 CEPT-2 10 20 CEPT-3 DS-3 STS-1 89.472 100 Telcordia Specification GR-139-CORE.	1.0 .3 1.0 4.2 .5 1.6 5.0 .6 2.0 10.0 .8 2.6 17.2 1.0 3.3 22.4 1.1 3.6 25.9 1.2 3.9 44.7 1.6 5.3 50.0 1.7 6.6 69.6 2.0 6.5 77.8 2.1 6.9 200 100.0 2.5 8.2 DS-4 137.1 2.9 9.5 400 200.0 3.6 11.8
	734A6	NEC: CMR CEC: CMG FT4	6	500 1000	152.4 304.8	142.5 293.0	64.6 132.9	same as above	.148 3.76 Coax OD: .235 5.97	same as above	.772 19.61	100% Sweep tested. RL: 30dB min. at 15 MHz to 95 MHz. Non-plenum versions comply with Telcordia Specification GR-139-CORE.						
734A12	NEC: CMR CEC: CMG FT4	12	500 1000	152.4 304.8	282.5 551.0	128.1 250.5	same as above	.148 3.76 Coax OD: .235 5.97	same as above	1.026 26.06								

Plenum • Foam FEP Insulation • Gray Flamarrest® Jacket

	734A1P	NEC: CMP CEC: CMP FT6	1	500 1000	152.4 304.8	16.5 36.0	7.5 16.3	same as above	.148 3.76	same as above	.215 5.46	75	80%	17.3	56.8	(same as above)	100% Sweep tested. RL: 30dB min. at 15 MHz to 95 MHz.
--	---------------	--------------------------------	---	-------------	----------------	--------------	-------------	---------------------	--------------	---------------------	--------------	----	-----	------	------	-----------------	--

BC = Bare Copper • DCR = DC Resistance • FEP = Fluorinated Ethylene Propylene • FHDPE = Foam High-density Polyethylene • TC = Tinned Copper
See chart on page 6.58 for maximum transmission distances.

*Lucent Technologies reference specification. Belden equivalent.

DS-3 and DS-4 Interconnect and Cross-connect Cable

734D* Series

Description	Part No.	UL NEC/ C(UL) CEC Type	No. of Cond.	Standard Lengths		Standard Unit Weight		Conductor (stranding) Diameter Nom. DCR	Nominal Core OD		Shielding Materials Nom. DCR	Nominal OD		Nom. Imp. (Ω)	Nom. Vel. of Prop.	Nominal Capacitance		Nominal Attenuation		
				Ft.	m	Lbs.	kg		Inch	mm		Inch	mm			pF/Ft.	pF/m	Stand. Signal (Mb/s)	MHz	dB/100 Ft.

20 AWG Solid .032" (.81mm) Silver-plated Copper Conductor(s) • Beldfoil® (100% Coverage) + Tinned Copper Braid Shield (85% Coverage)

Gas-injected FHDPE Insulation • Overall Gray PVC Jacket (Multiple coaxes feature inner Gray PVC jackets w/printed nos. for circuit ID)

	734D1	NEC: CMR CEC: CMG FT4	1	500 1000	152.4 304.8	16.0 36.0	7.3 16.3	20 AWG (solid) .032" SPC 10.0Ω/M' 32.8Ω/km	.148	3.76	Beldfoil + 85% TC Braid 2.4Ω/M' 7.9Ω/km	.235	5.97	75	80%	16.8	55.1	2	1.0	.3	1.0		
	734D1T	NEC: CMR CEC: CMG FT4	1 w/T	500 1000	152.4 304.8	17.5 39.0	7.9 17.7	same as above	.148	3.76	same as above	.235	5.97	x x	x x					CEPT-1	1.0	.3	1.0
	734D2	NEC: CMR CEC: CMG FT4	2	500 1000	152.4 304.8	35.5 66.0	16.1 29.9	same as above	.148	3.76	same as above	.235	5.97	x x	x x					CEPT-2	4.2	.5	1.6
	734D2T	NEC: CMR CEC: CMG FT4	2 w/T	500 † 1000 †	152.4 † 304.8 †	37.5 † 73.0 †	17.0 † 33.1 †	same as above	.148	3.76	same as above	.235	5.97	x x	x x					10	5.0	.6	2.0
PVC insulated trace.																							
	734D6	NEC: CMR CEC: CMG FT4	6	500 † 1000 †	152.4 † 304.8 †	141.0 290.0	64.1 131.8	same as above	.148	3.76	same as above	.772	19.61							20	10.0	.8	2.6
	734D12	NEC: CMR CEC: CMG FT4	12	500 † 1000 †	152.4 † 304.8 †	284.5 555.0	129.3 252.3	same as above	.148	3.76	same as above	1.026	26.06							20	10.0	.8	2.6

Siamese versions bonded in parallel, feature zip cord design with printing on one leg.

	734D2T	NEC: CMR CEC: CMG FT4	2 w/T	500 † 1000 †	152.4 † 304.8 †	37.5 † 73.0 †	17.0 † 33.1 †	same as above	.148	3.76	same as above	.235	5.97	x x	x x					CEPT-3	17.2	1.0	3.3
	734D6T	NEC: CMR CEC: CMG FT4	6 w/T	500 † 1000 †	152.4 † 304.8 †	141.0 † 290.0 †	64.1 † 131.8 †	same as above	.148	3.76	same as above	.772	19.61							DS-3	22.4	1.1	3.6

Siamese versions bonded in parallel, feature zip cord design with printing on one leg and PVC insulated tracer.

	734D6T	NEC: CMR CEC: CMG FT4	6 w/T	500 † 1000 †	152.4 † 304.8 †	141.0 † 290.0 †	64.1 † 131.8 †	same as above	.148	3.76	same as above	.772	19.61							DS-4	137.1	2.9	9.5
	734D12T	NEC: CMR CEC: CMG FT4	12 w/T	500 † 1000 †	152.4 † 304.8 †	284.5 † 555.0 †	129.3 † 252.3 †	same as above	.148	3.76	same as above	1.026	26.06							400	200.0	3.6	11.8

100% Sweep tested.
RL: 30dB min. at 15 MHz to 95 MHz.

Non-plenum versions comply with
Telcordia Specification GR-139-CORE.

Plenum • Foam FEP Insulation • Gray Flamarrest® Jacket

	734D1P	NEC: CMP CEC: CMP FT6	1	500 1000	152.4 304.8	17.0 37.0	7.7 16.8	same as above	.148	3.76	same as above	.215	5.46	75	80%	17.3	56.7			(same as above)			
																					100% Sweep tested. RL: 30dB min. at 15 MHz to 95 MHz.		

BC = Bare Copper • DCR = DC Resistance • FEP = Fluorinated Ethylene Propylene • FHDPE = Foam High-density Polyethylene • SPC = Silver-plated Copper • TC = Tinned Copper
See chart on page 6.58 for maximum transmission distances.

*Lucent Technologies reference specification. Belden equivalent. †Final put-ups may vary ±10% from length shown for spools or reels and ±5% for UnReel® cartons.

DS-3 and DS-4 Interconnect and Cross-connect Cable

728A* and 720A* Series

Description	Part No.	UL NEC/ C(UL) CEC Type	No. of Cond.	Standard Lengths		Standard Unit Weight		Conductor (stranding) Diameter Nom. DCR	Nominal Core OD		Shielding Materials Nom. DCR	Nominal OD		Nom. Imp. (Ω)	Nom. Vel. of Prop.	Nominal Capacitance		Nominal Attenuation			
				Ft.	m	Lbs.	kg		Inch	mm		Inch	mm			Stand. Signal (Mb/s)	MHz	dB/ 100 Ft.	dB/ 100m		
20 AWG Solid .031" Bare Copper Conductor • Tinned Copper/Bare Copper Double Braid Shield (98% Coverage)																					
Polyethylene Insulation • Gray PVC Jacket																					
Double Braid 60°C VW-1	9231 (728A*)	NEC: CMH CEC: CMH FT1	1	500	152.4	39.0	17.7	20 AWG (solid) .031" BC 9.9Ω/M' 32.5Ω/km	.198	5.03	TC Double Braid 98% Shield Coverage 1.1Ω/M' 3.6Ω/km	.305	7.75	75	66%	21.0	68.9	2	1.0	.3	1.0
				1000	304.8	76.0	34.5											CEPT-1	1.0	.3	1.0
																		CEPT-2	4.2	.5	1.6
																		10	5.0	.6	2.0
																		20	10.0	.8	2.6
																		CEPT-3	17.2	1.0	3.3
																		DS-3	22.4	1.1	3.6
																		STS-1	25.9	1.2	3.9
																		89.472	44.7	1.4	4.6
																		100	50.0	1.5	4.9
																		CEPT-4	69.6	2.0	6.6
																		STS-3	77.8	2.2	7.2
																		200	100.0	2.7	8.9
																		DS-4	137.1	3.1	10.2
																		400	200.0	3.7	12.1

Non-contaminating PVC jacket.

Suitable for Outdoor applications and Aerial when supported by a Messenger wire.

720A* Series Belden 720A Coaxial Cable Series is available by special request.
Contact the Belden Customer Service Department for quotes. 1-800-BELDEN-1.

BC = Bare Copper • DCR = DC Resistance • TC = Tinned Copper

See table below for maximum transmission distances.

*Lucent Technologies reference specification. Belden equivalent.

Maximum Transmission Distances for DS-3 and DS-4 Cable

Data Rates:	DS-3 (44.736 Mb/s)		STS-1 (51.86 Mb/s)		DS-4Na (CEPT-4) (139.264 Mb/s)		STS-3 (155.520 Mb/s)		DS-4 (274.176 Mb/s)	
	Belden Part No.	Interconnect	X-Connect	Interconnect	X-Connect	Interconnect	X-Connect	Interconnect	X-Connect	Interconnect
735A Series and 7351AP	225 ft. (68.6m)	21 ft. (6.4m)	210 ft. (64.0m)	20 ft. (6.1m)	125 ft. (38.1m)	13 ft. (4.0m)	120 ft. (36.6m)	11 ft. (3.4m)	90 ft. (27.4m)	8 ft. (2.4m)
734A and 734D Series	450 ft. (137.2m)	43 ft. (13.1m)	420 ft. (128.0m)	40 ft. (12.2m)	250 ft. (76.2m)	24 ft. (7.3m)	240 ft. (73.2m)	24 ft. (6.7m)	180 ft. (54.9m)	17 ft. (5.2m)
734A1P and 734D1P	435 ft. (132m)	43 ft. (13m)	410 ft. (125m)	40 ft. (12m)	240 ft. (73m)	24 ft. (7m)	225 ft. (68m)	22 ft. (8m)	170 ft. (52m)	17 ft. (5m)
728A	425 ft. (129.5m)	—	380 ft. (115.8m)	—	220 ft. (67.1m)	—	210 ft. (64.0m)	—	155 ft. (47.2m)	—
720A Series	225 ft. (68.6m)	25 ft. (7.6m)	230 ft. (70.1m)	23 ft. (7.0m)	140 ft. (42.7m)	14 ft. (4.3m)	130 ft. (39.6m)	13 ft. (4.0m)	100 ft. (30.5m)	9 ft. (2.7m)

DS = Digital Signal • STS = Synchronous Transmission Signal • CEPT = European Conference of Postal and Telecommunications Administrations

Please note: The signal loss budget for individual installations will affect the exact transmission distance.



Low Loss 50 Ohm Wireless RF Transmission Cable

RG-174 Type

Description	Part No.	UL NEC/ C(UL) CEC Type	Standard Lengths		Standard Unit Weight		Conductor (stranding) Diameter Nom. DCR	Nominal Core OD		Shielding Materials Nom. DCR	Nominal OD		Nom. Imp. (Ω)	Nom. Vel. of Prop.	Nominal Capacitance		Nominal Attenuation		
			Ft.	m	Lbs.	kg		Inch	mm		Inch	mm			pF/Ft.	pF/m	MHz	dB/100 Ft.	dB/100m
RG-174 Type • 25 AWG Solid .018" Bare Copper Conductor • Beldfoil® (100% Coverage) + Tinned Copper Braid Shield (90% Coverage)																			
Solid Polyethylene Insulation • Black PVC Jacket																			
RF100A 80°C 	7805	—	100†	30.5	1.8	.8	25 AWG	.061	1.55	Beldfoil + 90% TC Braid 9.1Ω/M' 29.9Ω/km	.110	2.79	50	66%	31.2	102.4	30	3.8	12.4
			500	152.4	5.5	2.5	(solid)				50	4.9			16.1				
			1000	304.8	10.0	4.5	.018"				150	8.6			28.2				
							BC				220	10.4			34.2				
							3.2Ω/M'				450	15.2			49.9				
							10.5Ω/km				900	22.0			72.3				
											1500	28.7			94.3				
											1800	31.7			104.0				
											2000	33.4			109.7				
											2500	37.8			124.2				
							3000	42.0	137.8										
							4500	52.3	171.5										
							5800	60.9	199.8										
							6000	62.0	203.3										
100% Sweep tested. 6 GHz. Max. VSWR 1.25:1 Belden® The Wire in Wireless.																			
Mates with standard RG-174 connectors. Suitable for Aerial applications when supported by a Messenger wire.																			

RG-174 Type • 24.5 AWG Solid .020" Bare Copper Conductor • Beldfoil + Tinned Copper Braid Shield (93% Coverage)

Foam HDPE Insulation • Gray PVC Jacket																			
RF100LL 80°C 	7805R	NEC:	100†	30.5	1.8	.8	24.5 AWG	.060	1.52	Beldfoil + 93% TC Braid 9.3Ω/M' 30.5Ω/km	.110	2.79	50	73.5%	26.2	86.0	30	3.5	11.5
		CMR:	500	152.4	5.5	2.5	(solid)				50	4.6			15.0				
		CEC:	1000	304.8	10.0	4.5	.020"				150	8.0			26.1				
						BC			220		9.6	31.6							
						27.3Ω/M'			450		14.0	46.1							
						94.2Ω/km			900		20.2	66.4							
									1500		26.6	87.3							
									1800		29.5	96.7							
									2000		31.2	102.3							
									2500		35.4	116.3							
							3000	39.4	129.2										
							4500	50.0	164.2										
							5800	59.0	193.6										
							6000	60.6	198.7										
100% Sweep tested. 6 GHz. Max. VSWR 1.25:1 Belden® The Wire in Wireless.																			
Mates with standard RG-174 connectors.																			

BC = Bare Copper • DCR = DC Resistance • HDPE = High-density Polyethylene • TC = Tinned Copper

†May contain more than one piece. Min. length of any one piece is 25 ft.

Low Loss 50 Ohm Wireless RF Transmission Cable

RG-58 Type

Description	Part No.	UL NEC/ C(UL) CEC Type	Standard Lengths		Standard Unit Weight		Conductor (stranding) Diameter Nom. DCR	Nominal Core OD		Shielding Materials Nom. DCR	Nominal OD		Nom. Imp. (Ω)	Nom. Vel. of Prop.	Nominal Capacitance		Nominal Attenuation		
			Ft.	m	Lbs.	kg		Inch	mm		Inch	mm			pF/Ft.	pF/m	MHz	dB/100 Ft.	dB/100m

RG-58 Type • 19 AWG Solid .037" Bare Copper Conductor • Duofoil® (100% Coverage) + Tinned Copper Braid Shield (90% Coverage)

Gas-injected Foam HDPE Insulation • Black Polyethylene Jacket

RF195 80°C	7806A	—	500	152.4	14.5	6.6	19 AWG (solid) .037" BC 7.6Ω/M' 24.9Ω/km	.110	2.79	Duofoil + 90% TC Braid 4.2Ω/M' 13.8Ω/km	.195	4.95	50	77%	24.3	79.7	30	2.0	6.6																							
			1000	304.8	23.0	10.4											50	2.5	8.2	150	4.0	13.3	220	4.9	16.1	450	7.1	23.4	900	10.3	33.8	1500	13.7	44.8	1800	15.2	49.7	2000	16.1	52.8	2500	18.3



100% Sweep tested. 6 GHz. Max. VSWR 1.25:1.
Belden® The Wire in Wireless.

Mates with standard RG-58 connectors.*
Suitable for Outdoor and Direct Burial applications.

Gas-injected Foam HDPE Insulation • Black PVC Jacket

RF195 80°C	7806R	NEC:	500	152.4	16.5	7.5	19 AWG (solid) .037" BC 7.6Ω/M' 24.9Ω/km	.110	2.79	Duofoil + 90% TC Braid 4.2Ω/M' 13.8Ω/km	.195	4.95	50	77%	24.3	79.7	30	2.0	6.6																								
		CMR:	1000	304.8	27.0	12.3											50	2.5	8.2	150	4.0	13.3	220	4.9	16.1	450	7.1	23.4	900	10.3	33.8	1500	13.7	44.8	1800	15.2	49.7	2000	16.1	52.8	2500	18.3	60.1



CMG FT4

100% Sweep tested. 6 GHz. Max. VSWR 1.25:1.
Belden® The Wire in Wireless.

Mates with standard RG-58 connectors.*

RG-58 Type • 17 AWG Solid .044" Bare Copper Conductor • Duofoil (100% Coverage) + Tinned Copper Braid Shield (95% Coverage)

Gas-injected Foam HDPE Insulation • Black Polyethylene Jacket

RF200 80°C	7807A	—	500	152.4	15.0	6.8	17 AWG (solid) .044" BC 3.3Ω/M' 10.9Ω/km	.116	2.95	Duofoil + 95% TC Braid 4.2Ω/M' 13.8Ω/km	.195	4.95	50	85%	23.5	77.1	30	1.6	5.4																							
			1000	304.8	24.0	10.9											50	2.1	7.0	150	3.7	12.1	220	4.5	14.6	450	6.5	21.2	900	9.2	30.1	1500	12.0	39.2	1800	13.2	43.2	2000	14.0	45.8	2500	15.7



100% Sweep tested. 6 GHz. Max. VSWR 1.25:1.
Belden® The Wire in Wireless.

Mates with standard Land Mobile Radio type connectors.*
Suitable for Outdoor and Direct Burial applications.

Gas-injected Foam HDPE Insulation • Black PVC Jacket

RF200 80°C	7807R	NEC:	500	152.4	13.5	6.1	17 AWG (solid) .044" BC 3.3Ω/M' 10.9Ω/km	.116	2.95	Duofoil + 95% TC Braid 4.2Ω/M' 13.8Ω/km	.195	4.95	50	85%	23.5	77.1	30	1.6	5.4																								
		CMR:	1000	304.8	27.0	12.3											50	2.1	7.0	150	3.7	12.1	220	4.5	14.6	450	6.5	21.2	900	9.2	30.1	1500	12.0	39.2	1800	13.2	43.2	2000	14.0	45.8	2500	15.7	51.6



CMG FT4

100% Sweep tested. 6 GHz. Max. VSWR 1.25:1.
Belden® The Wire in Wireless.

Mates with standard Land Mobile Radio type connectors.*

BC = Bare Copper • DCR = DC Resistance • HDPE = High-density Polyethylene • TC = Tinned Copper

*Please consult Belden's website, www.belden.com, for complete listing.

Low Loss 50 Ohm Wireless RF Transmission Cable

RG-8X Type

Description	Part No.	UL NEC/ C(UL) CEC Type	Standard Lengths		Standard Unit Weight		Conductor (stranding) Diameter Nom. DCR	Nominal Core OD		Shielding Materials Nom. DCR	Nominal OD		Nom. Imp. (Ω)	Nom. Vel. of Prop.	Nominal Capacitance		Nominal Attenuation		
			Ft.	m	Lbs.	kg		Inch	mm		Inch	mm			pF/Ft.	pF/m	MHz	dB/ 100 Ft.	dB/ 100m

RG-8X Type • 15 AWG Solid .057" Bare Copper Conductor • Duobond® II (100% Coverage) + Tinned Copper Braid Shield (95% Coverage)

Gas-injected Foam HDPE Insulation • Black Polyethylene Jacket

RF240 80°C	7808A	—	500	152.4	18.0	8.2	15 AWG (solid) .057" BC 3.2Ω/M' 10.5Ω/km	.150	3.81	Duobond II* + 95% TC Braid 2.8Ω/M' 9.2Ω/km	.240	6.10	50	86%	23.0	75.5	30	1.3	4.1
			1000	304.8	39.0	17.7											50	1.6	5.3
																			
100% Sweep tested. 6 GHz. Max. VSWR 1.25:1. Belden® The Wire in Wireless.																			
Mates with standard RG-8X connectors.** Suitable for Outdoor and Direct Burial applications.																			
220 3.4 11.1 450 4.9 16.1 900 7.0 22.9 1500 9.1 30.0 1800 10.1 33.2 2000 10.7 35.0 2500 12.0 39.5 3000 13.4 43.9 4500 16.7 54.7 5800 19.5 64.0 6000 19.8 65.0																			

Gas-injected Foam HDPE Insulation • Black PVC Jacket

RF240 80°C	7808R	NEC:	500	152.4	20.0	9.1	15 AWG (solid) .057" BC 3.2Ω/M' 10.5Ω/km	.150	3.81	Duobond II* + 95% TC Braid 2.8Ω/M' 9.2Ω/km	.240	6.10	50	86%	23.0	75.5	30	1.3	4.1
		CMR:	1000	304.8	44.0	20.0											50	1.6	5.3
																			
100% Sweep tested. 6 GHz. Max. VSWR 1.25:1. Belden® The Wire in Wireless.																			
Mates with standard RG-8X connectors.** Suitable for Outdoor and Direct Burial applications.																			
150 2.8 9.3 220 3.4 11.1 450 4.9 16.1 900 7.0 22.9 1500 9.1 30.0 1800 10.1 33.2 2000 10.7 35.0 2500 12.0 39.5 3000 13.4 43.9 4500 16.7 54.7 5800 19.5 64.0 6000 19.8 65.0																			

Gas-injected Foam HDPE Insulation • Flooded Water-resistant Black Polyethylene Jacket

RF240 80°C	7808WB	—	500	152.4	18.0	8.2	15 AWG (solid) .057" BC 3.2Ω/M' 10.5Ω/km	.150	3.81	Duobond II* + 95% TC Braid 2.8Ω/M' 9.2Ω/km	.240	6.10	50	86%	23.0	75.5	30	1.3	4.1
			1000	304.8	39.0	17.7											50	1.6	5.3
																			
100% Sweep tested. 6 GHz. Max. VSWR 1.25:1. Belden® The Wire in Wireless.																			
Mates with standard RG-8X connectors.** Suitable for Outdoor and Direct Burial applications.																			
150 2.8 9.3 220 3.4 11.1 450 4.9 16.1 900 7.0 22.9 1500 9.1 30.0 1800 10.1 33.2 2000 10.7 35.0 2500 12.0 39.5 3000 13.4 43.9 4500 16.7 54.7 5800 19.5 64.0 6000 19.8 65.0																			

BC = Bare Copper • DCR = DC Resistance • HDPE = High-density Polyethylene • TC = Tinned Copper

*Duobond II = Bonded Duofoil® (100% coverage) + aluminum braid (67% coverage).

**Please consult Belden's website, www.belden.com, for complete listing.

Low Loss 50 Ohm Wireless RF Transmission Cable

Intermediate Type

Description	Part No.	UL NEC/ C(UL) CEC Type	Standard Lengths		Standard Unit Weight		Conductor (stranding) Diameter Nom. DCR	Nominal Core OD		Shielding Materials Nom. DCR	Nominal OD		Nom. Imp. (Ω)	Nom. Vel. of Prop.	Nominal Capacitance		Nominal Attenuation		
			Ft.	m	Lbs.	kg		Inch	mm		Inch	mm			pF/Ft.	pF/m	MHz	dB/100 Ft.	dB/100m

Intermediate Type • 13 AWG Solid .072" Bare Copper Conductor • Duobond® II (100% Coverage) + Tinned Copper Braid Shield (95% Coverage)

Gas-injected Foam HDPE Insulation • Black Polyethylene Jacket

RF300 80°C	7809A	—	500	152.4	30.5	13.9	13 AWG (solid) .072" BC 2.1Ω/M' 6.9Ω/km	.190	4.83	Duobond II* + 95% TC Braid BC 2.4Ω/M' 7.8Ω/km	.300	7.62	50	86%	23.0	75.5	30	1.0	3.4
			1000	304.8	58.0	26.3											50	1.3	4.2
																	150	2.2	7.3
																	220	2.7	8.9
																	450	3.9	12.9
																	900	5.6	18.3
																	1500	7.3	24.0
																	1800	8.1	26.5
																	2000	8.6	28.2
																	2500	9.7	31.9
																	3000	10.8	35.4
																	4500	13.5	44.4
5800	15.8	51.8																	
6000	16.0	52.6																	

100% Sweep tested. 6 GHz. Max. VSWR 1.25:1.
Belden® The Wire in Wireless.

Mates with Land Mobile Radio type connectors.**
Suitable for Outdoor and Direct Burial applications.

Gas-injected Foam HDPE Insulation • Black PVC Jacket

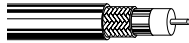
RF300 80°C	7809R	NEC:	500	152.4	34.0	15.5	13 AWG (solid) .072" BC 2.1Ω/M' 6.9Ω/km	.190	4.83	Duobond II* + 95% TC Braid BC 2.4Ω/M' 7.8Ω/km	.300	7.62	50	86%	23.0	75.5	30	1.0	3.4
		CMR:	1000	304.8	65.0	29.5											50	1.3	4.2
																	150	2.2	7.3
																	220	2.7	8.9
																	450	3.9	12.9
																	900	5.6	18.3
																	1500	7.3	24.0
																	1800	8.1	26.5
																	2000	8.6	28.2
																	2500	9.7	31.9
																	3000	10.8	35.4
																	4500	13.5	44.4
5800	15.8	51.8																	
6000	16.0	52.6																	

100% Sweep tested. 6 GHz. Max. VSWR 1.25:1.
Belden® The Wire in Wireless.

Mates with Land Mobile Radio type connectors.**

Gas-injected Foam HDPE Insulation • Flooded Water-resistant Black Polyethylene Jacket

RF300 80°C	7809WB	—	500	152.4	30.5	13.9	13 AWG (solid) .072" BC 2.1Ω/M' 6.9Ω/km	.190	4.83	Duobond II* + 95% TC Braid BC 2.4Ω/M' 7.8Ω/km	.300	7.62	50	86%	23.0	75.5	30	1.0	3.4
			1000	304.8	58.0	26.3											50	1.3	4.2
																	150	2.2	7.3
																	220	2.7	8.9
																	450	3.9	12.9
																	900	5.6	18.3
																	1500	7.3	24.0
																	1800	8.1	26.5
																	2000	8.6	28.2
																	2500	9.7	31.9
																	3000	10.8	35.4
																	4500	13.5	44.4
5800	15.8	51.8																	
6000	16.0	52.6																	

100% Sweep tested. 6 GHz. Max. VSWR 1.25:1.
Belden® The Wire in Wireless.

Mates with Land Mobile Radio type connectors.**
Suitable for Outdoor and Direct Burial applications.

BC = Bare Copper • DCR = DC Resistance • HDPE = High-density Polyethylene • TC = Tinned Copper

*Duobond II = Bonded Duofoil® (100% coverage) + aluminum braid (67% coverage).

**Please consult Belden's website, www.belden.com, for complete listing.

Low Loss 50 Ohm Wireless RF Transmission Cable

RG-8 Type

Description	Part No.	UL NEC/ C(UL) CEC Type	Standard Lengths		Standard Unit Weight		Conductor (stranding) Diameter Nom. DCR	Nominal Core OD		Shielding Materials Nom. DCR	Nominal OD		Nom. Imp. (Ω)	Nom. Vel. of Prop.	Nominal Capacitance		Nominal Attenuation		
			Ft.	m	Lbs.	kg		Inch	mm		Inch	mm			pF/Ft.	pF/m	MHz	dB/100 Ft.	dB/100m

RG-8 Type • 10 AWG Solid .108" Bare Copper-covered Aluminum Conductor • Duobond® II (100% Coverage) + Tinned Copper Braid Shield (95% Coverage)

Gas-injected Foam HDPE Insulation • Black Polyethylene Jacket

RF400 80°C	7810A	—	500	152.4	42.5	19.3	10 AWG (solid) .108" BCCA 1.34Ω/M' 4.4Ω/km	.285	7.24	Duobond II* + 95% TC Braid 2.0Ω/M' 9.2Ω/km	.403	10.23	50	86%	23.0	75.5	30	.7	2.1
			1000	304.8	86.0	39.0											50	.9	2.8
																	150	1.5	4.9
																	220	1.8	6.0
																	450	2.7	8.8
																	900	3.8	12.6
																	1500	5.1	16.6
																	1800	5.6	18.5
																	2000	6.0	19.6
																	2500	6.7	22.0
																	3000	7.5	24.4
																	4500	9.5	31.1
5800	11.1	36.4																	
6000	11.4	37.3																	

100% Sweep tested. 6 GHz. Max. VSWR 1.25:1.
Belden® The Wire in Wireless.

Mates with 9913 and Land Mobile Radio type connectors.**
Suitable for Outdoor and Direct Burial applications.

Gas-injected Foam HDPE Insulation • Black PVC Jacket

RF400 80°C	7810R*	NEC:	500	152.4	47.0	21.3	10 AWG (solid) .108" BCCA 1.34Ω/M' 4.4Ω/km	.285	7.24	Duobond II* + 95% TC Braid 2.0Ω/M' 9.2Ω/km	.403	10.23	50	86%	23.0	75.5	30	.7	2.1
		CMR:	1000	304.8	79.0	35.8											50	.9	2.8
																	150	1.5	4.9
																	220	1.8	6.0
																	450	2.7	8.8
																	900	3.8	12.6
																	1500	5.1	16.6
																	1800	5.6	18.5
																	2000	6.0	19.6
																	2500	6.7	22.0
																	3000	7.5	24.4
																	4500	9.5	31.1
5800	11.1	36.4																	
6000	11.4	37.3																	

100% Sweep tested. 6 GHz. Max. VSWR 1.25:1.
Belden® The Wire in Wireless.

Mates with 9913 and Land Mobile Radio type connectors.**
Suitable for Outdoor applications.

Gas-injected Foam HDPE Insulation • Flooded Water-resistant Black Polyethylene Jacket

RF400 80°C	7810WB	—	500	152.4	39.5	17.9	10 AWG (solid) .108" BCCA 1.34Ω/M' 4.4Ω/km	.285	7.24	Duobond II* + 95% TC Braid 2.0Ω/M' 9.2Ω/km	.403	10.23	50	86%	23.0	75.5	30	.7	2.1
			1000	304.8	80.0	36.3											50	.9	2.8
																	150	1.5	4.9
																	220	1.8	6.0
																	450	2.7	8.8
																	900	3.8	12.6
																	1500	5.1	16.6
																	1800	5.6	18.5
																	2000	6.0	19.6
																	2500	6.7	22.0
																	3000	7.5	24.4
																	4500	9.5	31.1
5800	11.1	36.4																	
6000	11.4	37.3																	

100% Sweep tested. 6 GHz. Max. VSWR 1.25:1.
Belden® The Wire in Wireless.

Mates with 9913 and Land Mobile Radio type connectors.**
Suitable for Outdoor and Direct Burial applications.

BCCA = Bare Copper-covered Aluminum • DCR = DC Resistance • HDPE = High-density Polyethylene • TC = Tinned Copper

*Duobond II = Bonded Duofoil® (100% coverage) + aluminum braid (67% coverage).

**Please consult Belden's website, www.belden.com, for complete listing.

Low Loss 50 Ohm Wireless RF Transmission Cable

Series RF500

Description	Part No.	UL NEC/ C(UL) CEC Type	Standard Lengths		Standard Unit Weight		Conductor (stranding) Diameter Nom. DCR	Nominal Core OD		Shielding Materials Nom. DCR	Nominal OD		Nom. Imp. (Ω)	Nom. Vel. of Prop.	Nominal Capacitance		Nominal Attenuation		
			Ft.	m	Lbs.	kg		Inch	mm		Inch	mm			pF/Ft.	pF/m	MHz	dB/100 Ft.	dB/100m

7 AWG Solid .142" Bare Copper-covered Aluminum Conductor • Duobond® II (100% Coverage) + Tinned Copper Braid Shield (90% Coverage)

Foam HDPE Insulation • Black Polyethylene Jacket																			
80°C	7976A <small>new</small>	—	500	152.4	56.0	25.4	7 AWG (solid)	.370	9.40	Duobond II* + 90% TC Braid	.500	12.70	50	84%	25.1	82.4	30	.6	1.8
			1000	304.8	108.0	49.0	.142" BCCA			1.6Ω/M'							50	.7	2.4
							.8Ω/M'			5.3Ω/km							150	1.2	3.9
							2.7Ω/km										220	1.5	4.9
																	450	2.2	7.2
																	900	3.2	10.5
																	1500	4.2	13.8
																	1800	4.7	15.4
																	2000	5.0	16.4
																	2500	5.7	18.7
																	3000	6.3	20.7
																	3500	6.9	22.6
																	4500	8.0	26.2
																	5800	9.3	30.5
																	6000	9.5	31.2

Suitable for Outdoor applications and Aerial applications when supported by a Messenger wire.

Foam HDPE Insulation • Black PVC Jacket																			
80°C	7976R <small>new</small>	NEC: CMR CEC: CMG FT4	500	152.4	67.5	30.6	7 AWG (solid)	.370	9.40	Duobond II* + 90% TC Braid	.500	12.70	50	84%	25.1	82.4	30	.6	1.8
			1000	304.8	131.0	59.5	.142" BCCA			1.6Ω/M'							50	.7	2.4
							.8Ω/M'			5.3Ω/km							150	1.2	3.9
							2.7Ω/km										220	1.5	4.9
																	450	2.2	7.2
																	900	3.2	10.5
																	1500	4.2	13.8
																	1800	4.7	15.4
																	2000	5.0	16.4
																	2500	5.7	18.7
																	3000	6.3	20.7
																	3500	6.9	22.6
																	4500	8.0	26.2
																	5800	9.3	30.5
																	6000	9.5	31.2

Suitable for Outdoor applications and Aerial applications when supported by a Messenger wire.

Foam HDPE Insulation • Flooded Water-resistant Black Polyethylene Jacket																			
80°C	7976WB <small>new</small>	—	500	152.4	56.5	25.7	7 AWG (solid)	.370	9.40	Duobond II* + 90% TC Braid	.500	12.70	50	84%	25.1	82.4	30	.6	1.8
			1000	304.8	109.0	49.9	.142" BCCA			1.6Ω/M'							50	.7	2.4
							.8Ω/M'			5.3Ω/km							150	1.2	3.9
							2.7Ω/km										220	1.5	4.9
																	450	2.2	7.2
																	900	3.2	10.5
																	1500	4.2	13.8
																	1800	4.7	15.4
																	2000	5.0	16.4
																	2500	5.7	18.7
																	3000	6.3	20.7
																	3500	6.9	22.6
																	4500	8.0	26.2
																	5800	9.3	30.5
																	6000	9.5	31.2

Suitable for Outdoor and Direct Burial applications and Aerial applications when supported by a Messenger wire.

BCCA = Bare Copper-covered Aluminum • DCR = DC Resistance • HDPE = High-density Polyethylene • TC = Tinned Copper

*Duobond II = Bonded Duofoil® (100% coverage) + aluminum braid (67% coverage).

Low Loss 50 Ohm Wireless RF Transmission Cable

Series RF600

Description	Part No.	UL NEC/ C(UL) CEC Type	Standard Lengths		Standard Unit Weight		Conductor (stranding) Diameter Nom. DCR	Nominal Core OD		Shielding Materials Nom. DCR	Nominal OD		Nom. Imp. (Ω)	Nom. Vel. of Prop.	Nominal Capacitance		Nominal Attenuation		
			Ft.	m	Lbs.	kg		Inch	mm		Inch	mm			pF/Ft.	pF/m	MHz	dB/100 Ft.	dB/100m

5.5 AWG Solid .176" Bare Copper-covered Aluminum Conductor • Duobond® II (100% Coverage) + Tinned Copper Braid Shield (85% Coverage)

Foam HDPE Insulation • Black Polyethylene Jacket

80°C	7977A <small>new</small>	—	500	152.4	73.5	33.4	5.5 AWG (solid) .176" BCCA .5Ω/M' 1.7Ω/km	.455	11.56	Duobond II* + 85% TC Braid 1.8Ω/M' 5.9Ω/km	.590	14.99	50	85%	24.6	80.7	30	.5	1.5
			1000	304.8	145.0	65.8											50	.6	2.0
																	150	1.0	3.2
																	220	1.2	3.9
																	450	1.7	5.6
																	900	2.5	8.3
																	1500	3.4	11.2
																	1800	3.8	12.4
																	2000	4.0	13.2
																	2500	4.6	15.0
																	3000	5.1	16.6
																	3500	5.6	18.2
4500	6.4	21.1																	
5800	7.6	24.8																	
6000	7.8	25.4																	

100% Sweep tested.
Belden® The Wire in Wireless.

Suitable for Outdoor applications and Aerial applications when supported by a Messenger wire.

Foam HDPE Insulation • Black PVC Jacket

80°C	7977R <small>new</small>	NEC: CMR CEC: CMG FT4	500	152.4	89.5	40.6	5.5 AWG (solid) .176" BCCA .5Ω/M' 1.7Ω/km	.455	11.56	Duobond II* + 85% TC Braid 1.8Ω/M' 5.9Ω/km	.590	14.99	50	84%	24.6	80.7	30	.5	1.5
			1000	304.8	173.0	78.5											50	.6	2.0
																	150	1.0	3.2
																	220	1.2	3.9
																	450	1.7	5.6
																	900	2.5	8.3
																	1500	3.4	11.2
																	1800	3.8	12.4
																	2000	4.0	13.2
																	2500	4.6	15.0
																	3000	5.1	16.6
																	3500	5.6	18.2
4500	6.4	21.1																	
5800	7.6	24.8																	
6000	7.8	25.4																	

100% Sweep tested.
Belden® The Wire in Wireless.

Suitable for Outdoor applications and Aerial applications when supported by a Messenger wire.

Foam HDPE Insulation • Flooded Water-resistant Black Polyethylene Jacket

80°C	7977WB <small>new</small>	—	500	152.4	74.0	33.6	5.5 AWG (solid) .176" BCCA .5Ω/M' 1.7Ω/km	.455	11.56	Duobond II* + 85% TC Braid 1.8Ω/M' 5.9Ω/km	.590	14.99	50	85%	24.6	80.7	30	.5	1.5
			1000	304.8	146.0	66.3											50	.6	2.0
																	150	1.0	3.2
																	220	1.2	3.9
																	450	1.7	5.6
																	900	2.5	8.3
																	1500	3.4	11.2
																	1800	3.8	12.4
																	2000	4.0	13.2
																	2500	4.6	15.0
																	3000	5.1	16.6
																	3500	5.6	18.2
4500	6.4	21.1																	
5800	7.6	24.8																	
6000	7.8	25.4																	

100% Sweep tested.
Belden® The Wire in Wireless.

Suitable for Outdoor and Direct Burial applications and Aerial applications when supported by a Messenger wire.

BCCA = Bare Copper-covered Aluminum • DCR = DC Resistance • HDPE = High-density Polyethylene • TC = Tinned Copper

*Duobond II = Bonded Duofoil® (100% coverage) + aluminum braid (67% coverage).

Low Loss 50 Ohm Wireless RF Transmission Coax

Electrical Characteristics

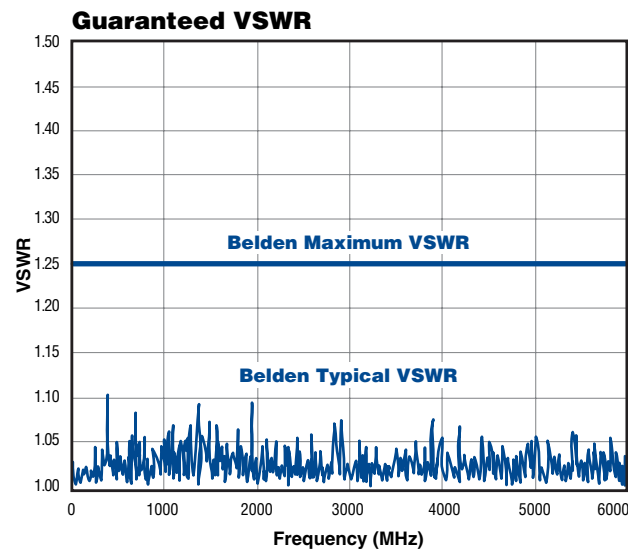
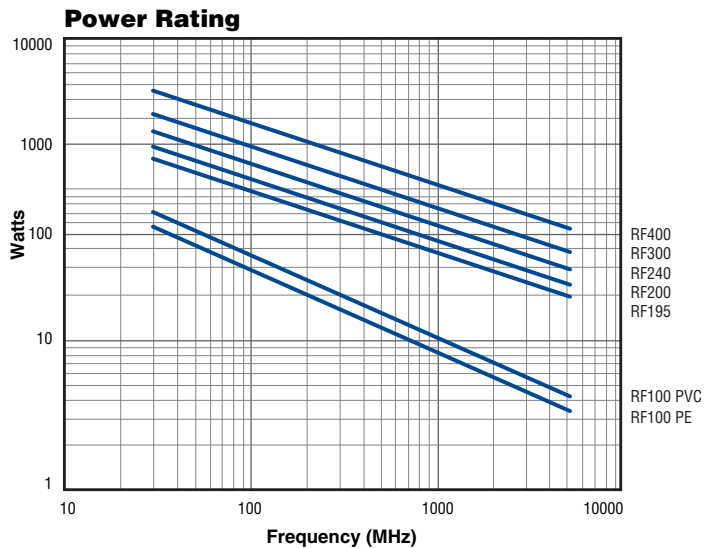
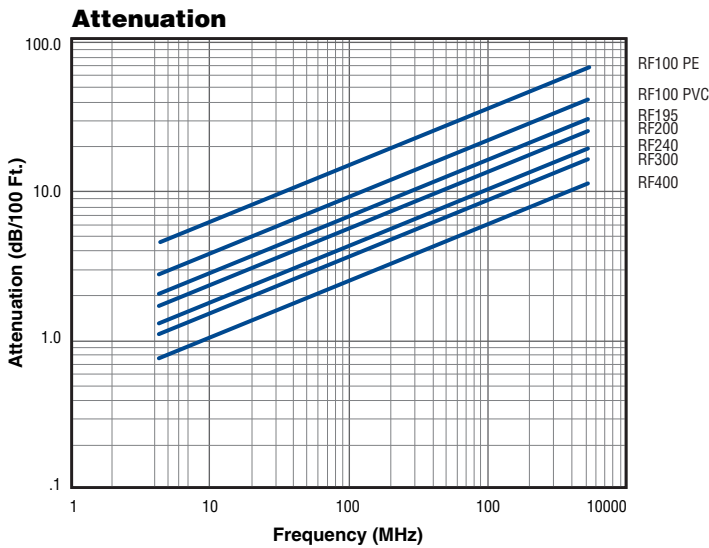

Voltage Standing Wave Ratio is a measurement of the reflected power in a cable or instrument. The higher the VSWR the poorer the transmission characteristics of the cable.

Phase Stability

Phase Attribute	Typical Range (0.45 GHz to 6.0 GHz)	
	ppm/°C	Degree/GHz/m

Temperature (-40°C to +85°C) ¹	±9	±0.6
Bending & Flexing (25 cycles) ²	NA	±1.1

1: Per IEC 60966-1 clause 8.8
2: Per IEC 60966-1 clause 8.6

RG Cable Replacement Guide

Part Number	Size	Replacing
7805	RF100A	RG-174/U
7805R	RF100LL	RG-174/U
7806A	RF195	RG-58/U
7807A	RF200	RG-58/U
7808A	RF240	RG-8X
7809A	RF300	RG-8X
7810A	RF400	RG-8U

50 Ohm Transmission and Computer Cable

RG-188A/U, RG-174/U and RG-58/U Type

Description	Part No.	UL NEC/ C(UL) CEC Type	Standard Lengths		Standard Unit Weight		Conductor (stranding) Diameter Nom. DCR	Nominal Core OD		Shielding Materials Nom. DCR	Nominal OD		Nom. Imp. (Ω)	Nom. Vel. of Prop.	Nominal Capacitance		Nominal Attenuation		
			Ft.	m	Lbs.	kg		Inch	mm		Inch	mm			pF/Ft.	pF/m	MHz	dB/100 Ft.	dB/100m

RG-174/U Type • 26 AWG Stranded (7x34) .019" Bare Copper-covered Steel Conductor • Tinned Copper Braid Shield (90% Coverage)

Polyethylene Insulation • Black PVC Jacket

UL AWM Style 1354 (30V 75°C)	8216	—	100	30.5	1.1	.5	26 AWG (7x34)	.060	1.52	TC Braid	.110	2.79	50	66%	30.8	101.0	1	1.9	6.2
			500	152.4	5.0	2.3				90% Shield							10	3.3	10.8
			1000††	304.8	9.0	4.1	.019"			Coverage							50	5.8	19.0
							BCCS			10.7Ω/M'							100	8.4	27.6
							97.0Ω/M'			35.1Ω/km							200	12.5	41.0
							318.2Ω/km										400	19.0	62.3
																	700	27.0	88.6
																	900	31.0	101.7
																	1000	34.0	111.5



RG-188A/U Type • 26 AWG Stranded (7x34) .020" Silver-plated Copper-covered Steel Conductor • SPC Braid Shield (96% Coverage)

TFE Teflon® Insulation • White TFE Tape Jacket

200°C VW-1	83269	—	100†	30.5	2.0	.9	26 AWG (7x34)	.058	1.47	SPC Braid	.098	2.49	50	69.5%	29.0	95.1	1	1.2	3.9
			500†	152.4	6.5	2.9	.020"			96% Shield							10	2.7	8.9
			1000†	304.8	12.0	5.5				Coverage							50	5.6	18.4
							SCCCS			8.5Ω/M'							100	8.3	27.2
							91.2Ω/M'			27.9Ω/km							200	12.0	39.4
							299.2Ω/km										400	17.5	57.4
																	700	23.7	77.8
																	900	27.3	89.6
																	1000	29.0	95.1

MIL-C-17D

RG-58/U Type • 20 AWG Solid .033" Bare Copper Conductor • Bare Copper Braid Shield (78% Coverage)

Polyethylene Insulation • Black PVC Jacket

80°C	9201	—	U-500	U-152.4	13.0	5.9	20 AWG (solid)	.116	2.95	BC Braid	.193	4.90	51.5	66%	28.5	93.5	1	.3	1.1
			500	152.4	11.5	5.2	.033"			78% Shield							10	1.1	3.6
			U-1000	U-304.8	25.0	11.4				Coverage							50	2.5	8.2
			1000	304.8	23.0	10.4	BC			5.5Ω/M'							100	3.8	12.5
							10.0Ω/M'			18.0Ω/km							200	5.6	18.4
							33.1Ω/km										400	8.4	27.6
																	700	11.7	38.4
																	900	13.7	44.9
																	1000	14.5	47.6

RG-58/U Type • 20 AWG Solid .033" Bare Copper Conductor • Duobond® II + Tinned Copper Braid Shield (55% Coverage)

Polyethylene Insulation • Black PVC Jacket

UL AWM Style 1354 (30V 60°C)	9310**	—	500	152.4	10.5	4.8	20 AWG (solid)	.114	2.90	Duobond II* + 55%	.193	4.90	50	66%	30.8	101.0	1	.5	1.5
			U-1000	U-304.8	22.0	10.0	.033"			TC Braid							10	1.4	4.6
			1000	304.8	21.0	9.5				Coverage							50	2.8	9.2
							BC			8.0Ω/M'							100	3.8	12.5
							9.4Ω/M'			24.4Ω/km							200	5.4	17.7
							28.6Ω/km										400	7.9	25.9
																	700	11.1	36.4
																	900	12.8	42.0
																	1000	13.9	45.6

BC = Bare Copper • BCCS = Bare Copper-covered Steel • DCR = DC Resistance • SCCCS = Silver-coated Copper-covered Steel • SPC = Silver-plated Copper • TC = Tinned Copper • TFE = Tetra Fluoroethylene
 Contact the Belden Customer Service Department for a Comprehensive Connector Cross Reference. **1-800-BELDEN-1**. Request quotations of RG/U cables not listed.

*Duobond II = Bonded Duofoil® (100% coverage) + aluminum braid (67% coverage).

**See Belden's website, www.belden.com, for connector information.

† May contain more than one piece, min. length of any one piece is 25 ft.

†† May contain more than one piece, min. length of any one piece is 100 ft. Length may vary ±10% from length shown.

Teflon is a DuPont trademark.



For more information, contact Belden Technical Support: **1-800-BELDEN-1** • www.belden.com

50 Ohm Transmission and Computer Cable

RG-58A/U Type

Description	Part No.	UL NEC/ C(UL) CEC Type	Standard Lengths		Standard Unit Weight		Conductor (stranding) Diameter Nom. DCR	Nominal Core OD		Shielding Materials Nom. DCR	Nominal OD		Nom. Imp. (Ω)	Nom. Vel. of Prop.	Nominal Capacitance		Nominal Attenuation		
			Ft.	m	Lbs.	kg		Inch	mm		Inch	mm			pF/Ft.	pF/m	MHz	dB/ 100 Ft.	dB/ 100m

RG-58A/U Type • 20 AWG Stranded (19x32) .037" Tinned Copper Conductor • Tinned Copper Braid Shield (96% Coverage)

Foam Polyethylene Insulation • Black or White PVC Jacket																			
UL AWM	8219	NEC:	U-500	U-152.4	13.5	6.1	20 AWG	.114	2.90	TC Braid	.194	4.93	53.5	73%	26.5	86.9	1	.4	1.2
Style 1354		CM	500 [▲]	152.4	13.0	6.0	(19x32)			96% Shield							10	1.3	4.3
(30V 80°C)		CEC:	U-1000 [▲]	U-304.8	27.0	12.3	.037"			Coverage							50	3.1	10.2
		CM	1000	304.8	26.0	11.8	TC			4.1Ω/M'							100	4.5	14.8
							8.8Ω/M'			13.4Ω/km							200	6.6	21.7
						28.9Ω/km										400	10.0	32.8	
																700	14.2	46.6	
																900	16.6	54.5	
																1000	18.1	59.4	

P-MSHA • SC-182/5**

*500 ft. and U-1000 ft. put-ups available in Black only. Black jacket suitable for Aerial (when supported by a messenger) and Outdoor applications.

RG-58A/U Type • 20 AWG Stranded (19x32) .037" Tinned Copper Conductor • Duobond® II* + Tinned Copper Braid Shield (55% Coverage)

Foam Polyethylene Insulation • Black PVC Jacket																			
UL AWM	9311**	NEC:	500	152.4	10.5	4.8	20 AWG	.114	2.90	Duobond II*	.193	4.90	52	75%	26.0	85.3	1	.5	1.6
Style 1354		CM	U-1000	U-304.8	23.0	10.5	(19x32)			+ 55% TC							10	1.5	4.9
(30V 80°C)		CEC:	1000	304.8	21.0	9.5	.037"			Braid							50	2.9	9.5
		CM					TC			17.0Ω/M'							100	4.0	13.1
							8.8Ω/M'			55.8Ω/km							200	5.7	18.7
						28.9Ω/km										400	8.5	27.9	
																700	12.2	40.0	
																900	14.5	47.6	
																1000	15.8	51.8	

RG-58A/U Type • 20 AWG Stranded (19x33) .035" Tinned Copper Conductor • Tinned Copper Braid Shield (95% Coverage)

Polyethylene Insulation • Black PVC Jacket																			
75°C	8259	—	100	30.5	3.5	1.6	20 AWG	.116	2.95	TC Braid	.192	4.88	50	66%	30.8	101.0	1	.4	1.4
			U-500	U-152.4	13.5	6.1	(19x33)			95% Shield							10	1.5	4.9
			500	152.4	13.5	6.1	.035"			Coverage							50	3.7	12.1
			U-1000	U-304.8	25.0	11.3	TC			4.1Ω/M'							100	5.4	17.7
			1000	304.8	26.0	11.8	10.8Ω/M'			13.4Ω/km							200	8.1	26.6
						35.4Ω/km										400	12.4	40.7	
																700	17.7	58.1	
																900	21.1	69.2	
																1000	22.8	74.8	

Suitable for Aerial (when supported by a messenger) and Outdoor applications.

RG-58A/U Type • 20 AWG Solid Bare Copper Conductor • Tinned Copper Braid Shield (95% Coverage)

Polyethylene Insulation • Black PVC Jacket																			
UL AWM	8240	NEC:	100	30.5	3.6	1.6	20 AWG	.116	2.95	TC Braid	.193	4.90	51.5	66%	28.5	93.5	1	.3	1.1
Style 1354		CMX	U-500	U-152.4	14.0	6.4	(solid)			95% Shield							10	1.1	3.6
(30V 80°C)		CEC:	500	152.4	13.0	5.9	.033"			Coverage							50	2.5	8.2
VW-1		CMX	U-1000	U-304.8	27.0	12.3	BC			4.1Ω/M'							100	3.8	12.5
			1000	304.8	26.0	11.8	10.0Ω/M'			13.4Ω/km							200	5.6	18.4
						32.8Ω/km										400	8.4	27.6	
																700	11.7	38.4	
																900	13.7	44.9	
																1000	14.5	47.6	

Suitable for Aerial (when supported by a messenger) and Outdoor applications.

Plenum • FEP Teflon® Insulation • Black FEP Teflon Jacket																			
200°C	88240	NEC:	500 [†]	152.4	12.0	5.4	20 AWG	.107	2.72	TC Braid	.159	4.04	53.5	69.5%	26.4	86.6	1	.5	1.6
		CMP	1000 [†]	304.8	24.0	10.9	(solid)			95% Shield							10	1.2	3.9
		CEC:					.032"			Coverage							50	3.0	9.8
		CMP FT6					BC			6.7Ω/M'							100	4.3	14.2
							10.2Ω/M'			22.0Ω/km							200	6.4	21.0
						33.5Ω/km										400	9.7	31.7	
																700	13.7	45.0	
																900	16.1	52.8	
																1000	17.3	56.6	

Plenum • FEP Teflon Insulation • Natural Flammarrest® Jacket																			
75°C	82240	NEC:	U-500 [†]	U-152.4	13.5	6.1	20 AWG	.107	2.72	TC Braid	.159	4.04	53.5	69.5%	26.4	86.6	1	.5	1.6
		CMP	U-1000 [†]	U-304.8	26.0	11.8	(solid)			95% Shield							10	1.2	3.9
		CEC:	1000 [†]	304.8	24.0	10.9	.032"			Coverage							50	3.0	9.8
		CMP FT6					BC			6.7Ω/M'							100	4.3	14.2
							10.2Ω/M'			22.0Ω/km							200	6.4	21.0
						33.5Ω/km										400	9.7	31.7	
																700	13.7	45.0	
																900	16.1	52.8	
																1000	17.3	56.6	

BC = Bare Copper • DCR = DC Resistance • FEP = Fluorinated Ethylene Propylene • TC = Tinned Copper

*Duobond II = Bonded Duofoil® (100% coverage) + aluminum braid (67% coverage).

**Pennsylvania Department of Environmental Resource and United States Mine Safety and Health Administration certification.

†Spools and/or UnReel® cartons are one piece, but length may vary ±10% from length shown.

Contact the Belden Customer Service Department for a Comprehensive Connector Cross Reference. **1-800-BELDEN-1**. Request quotation of RG/U cables not listed.

See Belden's website, www.belden.com, for connector information.

Teflon is a DuPont trademark.



50 Ohm Transmission and Computer Cable

RG-8X and RG-8/U Type

Description	Part No.	UL NEC/ C(UL) CEC Type	Standard Lengths		Standard Unit Weight		Conductor (stranding) Diameter Nom. DCR	Nominal Core OD		Shielding Materials Nom. DCR	Nominal OD		Nom. Imp. (Ω)	Nom. Vel. of Prop.	Nominal Capacitance		Nominal Attenuation		
			Ft.	m	Lbs.	kg		Inch	mm		Inch	mm			pF/Ft.	pF/m	MHz	dB/100 Ft.	dB/100m

RG-8X Type • 16 AWG Stranded (19x29) .058" Bare Copper Conductor • Bare Copper Braid Shield (95% Coverage)

Gas-injected FPE Insulation • Black PVC Jacket

UL AWM	9258	NEC:	U-500	U-152.4	20.0	9.1	16 AWG	.155	3.94	BC Braid	.242	6.15	50	82%	24.8	75.6	1	.3	1.0
Style 1354		CM	500	152.4	18.5	8.4	(19x29)			95% Shield							10	.9	3.0
(30V 80°C)		CEC:	U-1000	U-304.8	39.0	17.7	.058"			Coverage							50	2.1	6.9
		CM	1000 [▲]	304.8	40.0	18.2	BC			3.3Ω/M'							100	3.1	10.2
							4.3Ω/M'			10.8Ω/km							200	4.5	14.8
						14.1Ω/km										400	6.6	21.7	
																700	9.1	29.9	
																900	10.7	35.1	
																1000	11.2	36.7	

▲1000 ft. put-up also available in White.
Suitable for Outdoor and Aerial applications.

RG-8/U Type • 13 AWG Stranded (7x21) .085" Bare Copper Conductor • Bare Copper Braid Shield (97% Coverage)

Polyethylene Insulation • Black PVC Jacket

75°C	8237	NEC:	100	30.5	13.6	6.2	13 AWG	.285	7.24	BC Braid	.405	10.29	52	66%	28.5	93.5	1	.2	.5
		CMH	500	152.4	58.0	26.3	(7x21)			97% Shield							10	.6	1.8
		CEC:	1000	304.8	114.0	51.7	.085"			Coverage							50	1.3	4.3
		CMH FT1					BC			1.2Ω/M'							100	1.9	6.2
							1.9Ω/M'			3.9Ω/km							200	2.8	9.2
						6.2Ω/km										400	4.2	13.8	
																700	5.9	19.4	
																900	6.9	22.6	
																1000	7.4	24.3	
																4000	23.2	76.1	

JAN-C-17A
Suitable for Outdoor and Aerial applications.

Polyethylene Insulation • Black Non-contaminating PVC Jacket

UL AWM	9251	NEC:	500	152.4	58.0	26.3	13 AWG	.285	7.24	BC Braid	.405	10.29	52	66%	28.5	93.5	1	.2	.5
Style 1354		CMX	1000	304.8	115.0	52.3	(7x21)			97% Shield							10	.6	1.8
(30V 60°C)		CEC:					.085"			Coverage							50	1.3	4.3
		CMX					BC			1.2Ω/M'							100	1.9	6.2
							1.9Ω/M'			3.9Ω/km							200	2.8	9.2
						6.2Ω/km										400	4.2	13.8	
																700	5.9	19.4	
																900	6.9	22.6	
																1000	7.4	24.3	
																4000	23.2	76.1	

MIL-C-17D

RG-8/U Type • 11 AWG Stranded (7x19) .108" Bare Copper Conductor • Bare Copper Braid Shield (97% Coverage)

Foam Polyethylene Insulation • Black PVC Jacket

UL AWM	8214	NEC:	100	30.5	14.2	6.5	11 AWG	.285	7.24	BC Braid	.403	10.24	50	78%	26	85.3	1	.1	.5
Style 1354		CM	500	152.4	61.0	27.7	(7x19)			97% Shield							10	.5	1.7
(30V 80°C)		CEC:	1000	304.8	121.0	55.0	.108"			Coverage							50	1.2	3.9
		CM					BC			1.1Ω/M'							100	1.7	5.6
							1.2Ω/M'			3.6Ω/km							200	2.6	8.5
						3.9Ω/km										400	3.9	12.8	
																700	5.6	18.4	
																900	6.5	21.3	
																1000	7.0	23.0	
																4000	21.5	70.5	

Suitable for Outdoor and Aerial applications.

BC = Bare Copper • DCR = DC Resistance • FPE = Foam Polyethylene • HDPE = High-density Polyethylene • TC = Tinned Copper

Contact the Belden Customer Service Department for a Comprehensive Connector Cross Reference. 1-800-BELDEN-1. Request quotations of RG/U cables not listed.

50 Ohm Transmission and Computer Cable

RG-8/U Type

Description	Part No.	UL NEC/ C(UL) CEC Type	Standard Lengths		Standard Unit Weight		Conductor (stranding) Diameter Nom. DCR	Nominal Core OD		Shielding Materials Nom. DCR	Nominal OD		Nom. Imp. (Ω)	Nom. Vel. of Prop.	Nominal Capacitance		Nominal Attenuation		
			Ft.	m	Lbs.	kg		Inch	mm		Inch	mm			pF/Ft.	pF/m	MHz	dB/100 Ft.	dB/100m

RG-8/U Type • 10 AWG Solid .108" Bare Copper Conductor • Duobond® II + Tinned Copper Braid Shield (90% Coverage)

Semi-solid Polyethylene Insulation • Black PVC Jacket																							
Low Loss 80°C	9913	—	100	30.5	14.2	6.4	10 AWG	.286	7.26	Duobond II*	.405	10.29	50	84%	24.6	80.7	1	.3	1.0				
			250	76.2	31.8	14.4	(solid)			+ 90%								10	.5	1.7			
			500	152.4	57.0	25.9	.108"			TC Braid									50	1.0	3.3		
				1000	304.8	116.0	52.6	BC			1.8Ω/M'									100	1.4	4.6	
								.9Ω/M'			5.9Ω/km										200	1.8	6.0
								3.0Ω/km													400	2.6	8.5
																		700	3.6	11.8			
																		900	4.1	13.5			
																		1000	4.4	14.4			
																		4000	9.5	31.1			

Suitable for Outdoor and Aerial applications.

Plenum • Semi-solid FEP Insulation • Black Fluorocopolymer Jacket																							
150°C	89913	NEC: CMP CEC: CMP FT6	500†	152.4	63.0	28.6	10 AWG	.295	7.49	Duobond II*	.364	9.25	50	83%	25.0	82.0	1	.1	.3				
			1000†	304.8	128.0	58.2	(solid)			+ 90%									10	.4	1.3		
							.108"			TC Braid										50	1.0	3.3	
							BC			1.8Ω/M'										100	1.6	5.2	
								.9Ω/M'			5.9Ω/km										200	2.3	7.5
								3.0Ω/km													400	3.4	11.1
																		700	5.0	16.4			
																		900	6.0	19.7			
																		1000	6.9	22.6			
																		4000	17.0	55.8			

RG-8/U Type • 10 AWG Stranded (7x19) .108" Bare Copper Conductor • Duobond II + Tinned Copper Braid Shield (95% Coverage)

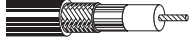
Gas-injected Foam HDPE Insulation • Matte Black Belflex® Jacket																							
Low Loss 80°C	9913F7	—	100	30.5	12.5	5.7	10 AWG	.285	7.24	Duobond II*	.405	10.29	52	85%	22.5	80.7	1	.4	1.3				
			250	76.2	27.8	12.6	(7x19)			+ 95% TC									10	.6	2.0		
			500	152.4	52.5	23.8	.108"			Braid										50	1.1	3.6	
				1000	304.8	104.0	47.2	BC			1.8Ω/M'									100	1.5	4.9	
								1.1Ω/M'			5.9Ω/km										200	2.0	6.6
								3.7Ω/km													400	3.0	9.8
																		700	4.0	13.1			
																		900	4.7	15.4			
																		1000	5.0	16.4			
																		4000	12.1	39.7			

Suitable for Outdoor and Aerial applications.

RG-8/U Type • 10 AWG Solid .103" Bare Copper Conductor • Duobond II + Tinned Copper Braid Shield (95% Coverage)

Gas-injected Foam HDPE Insulation • Black PVC Jacket																							
Low Loss UL AWM Style 1354 (30V 80°C)	9914	NEC: CMG CEC: CMG FT4	500	152.4	56.0	25.4	10 AWG	.285	7.24	Duobond II*	.403	10.24	50	82%	24.8	81.4	1	.4	1.3				
			1000	304.8	114.0	51.7	(solid)			+ 95%									10	.5	1.7		
							.103"			TC Braid										50	1.0	3.3	
							BC			1.1Ω/M'										100	1.4	4.6	
								1.8Ω/M'			3.6Ω/km										200	1.8	6.0
								3.9Ω/km													400	2.6	8.5
																		700	3.6	11.8			
																		900	4.1	13.5			
																		1000	4.4	14.4			
																		4000	9.9	32.5			

Suitable for Outdoor and Aerial applications.

RG-8/U Type • 10 AWG Solid .108" Bare Copper Conductor • Duofoil® (100% Coverage) + Tinned Copper Braid Shield (90% Coverage)

Plenum • Foam FEP Insulation • Black Fluorocopolymer Jacket																							
Low Loss 125°C	7733A	NEC: CMP CEC: CMP FT6	500	152.4	53.5	24.3	10 AWG	.280	7.11	Duofoil	.355	9.01	50	84%	24.2	79.4	1	.1	.3				
			1000	304.8	105.0	47.7	(solid)			+ 90%									10	.4	1.3		
							.108"			TC Braid										50	1.1	3.6	
							BC			1.8Ω/M'										100	1.5	4.9	
								.9Ω/M'			5.9Ω/km										200	2.1	6.9
								3.0Ω/km													400	3.2	10.5
																		700	4.5	14.8			
																		900	5.7	18.7			
																		1000	5.9	19.4			
																		4000	14.1	46.3			

Suitable for Outdoor and Aerial applications.

BC = Bare Copper • DCR = DC Resistance • FEP = Fluorinated Ethylene Propylene • HDPE = High-density Polyethylene • TC = Tinned Copper

Contact the Belden Customer Service Department for a Comprehensive Connector Cross Reference. **1-800-BELDEN-1**. Request quotations of RG/U cables not listed.

*Duobond II = Bonded Duofoil (100% coverage) + aluminum braid (67% coverage).

†Spools are one piece, but length may vary ±10% from length shown.

50 Ohm Transmission Cable

Electrical Characteristics of 9913, 9913F7 and 9914

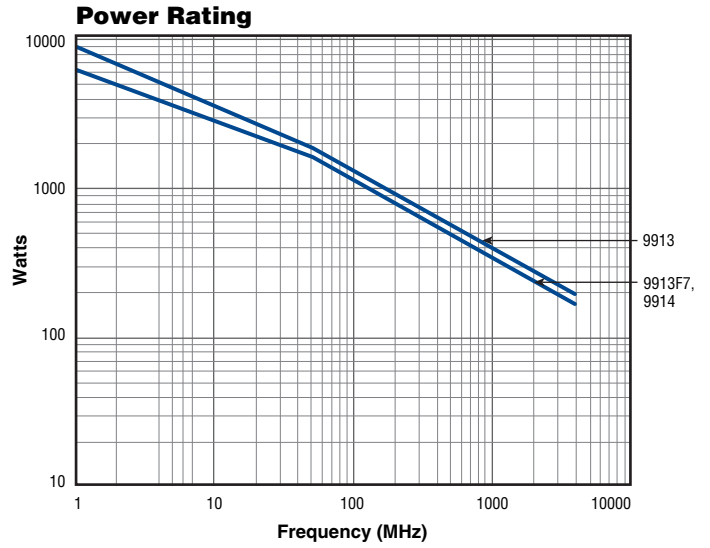
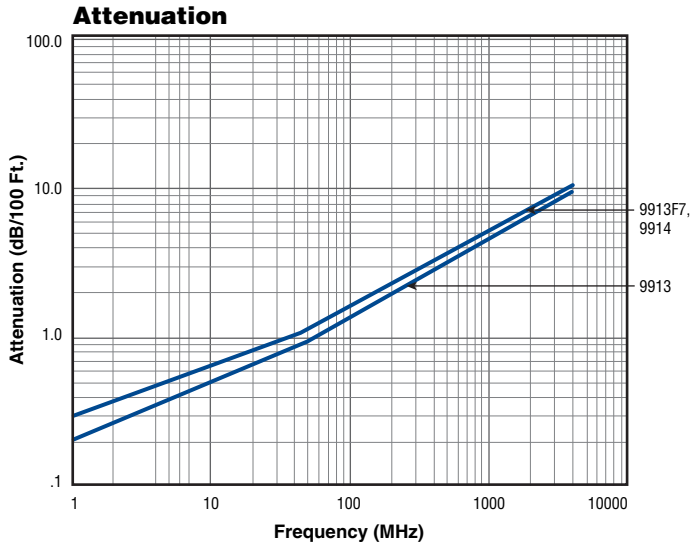

Conformable® Coax Cable

50 Ohm Microwave Cables

Description	Part No.	UL NEC/ C(UL) CEC Type	Standard Lengths		Standard Unit Weight		Conductor (stranding) Diameter Nom. DCR	Nominal Core OD		Shielding Materials Nom. DCR	Nominal OD		Nom. Imp. (Ω)	Nom. Vel. of Prop.	Nominal Capacitance		Nominal Attenuation		
			Ft.	m	Lbs.	kg		Inch	mm		Inch	mm			pF/Ft.	pF/m	MHz	dB/100 Ft.	dB/100m

M17/151 Type • 29 AWG Solid .011" Silver-plated Copper-covered Steel Conductor • Copper-Tin Composite Shield (100% Coverage)

TFE Teflon® Insulation • Unjacketed																			
UL AWM	1674A*	—	50	15.2	.2	.1	29 AWG	.034	.85	CT	.047	1.19	50	69.5%	29.5	96.8	500	25.0	82.0
Style 10245 (30V 105°C)			100	30.5	.4	.2	(solid)			Composite							1000	36.7	120.3
			500	152.4	2.0	.9	.011"			100% Shield							2000	53.8	176.5
			1000	304.8	5.0	2.3	SPCCS			Coverage							3000	67.3	220.8
							205.0Ω/M'			8.0Ω/M'							5000	89.2	292.8
							672.4Ω/km			26.2Ω/km							7000	107.5	352.6
																	10000	130.9	429.5
																	15000	163.8	537.4
																	18000	181.1	594.3
																	20000	192.0	630.0



M17/151 Type • 29 AWG Solid .011" Silver-plated Copper Conductor • Copper-Tin Composite Shield (100% Coverage)

TFE Teflon Insulation • Unjacketed																			
UL AWM	1674B*	—	100††	30.5	.4	.2	29 AWG	.034	.85	CT	.047	1.19	50	69.5%	29.5	96.8	500	25.0	82.0
Style 10245 (30V 105°C)			500††	152.4	2.0	.9	(solid)			Composite							1000	36.7	120.3
			1000††	304.8	5.0	2.3	.011"			100% Shield							2000	53.8	176.5
							SPC			Coverage							3000	67.3	220.8
							81.2Ω/M'			8.0Ω/M'							5000	89.2	292.8
							266.4Ω/km			26.2Ω/km							7000	107.5	352.6
																	10000	130.9	429.5
																	15000	163.8	537.4
																	18000	181.1	594.3
																	20000	192.0	630.0



RG-405/U Type • 24 AWG Solid .020" Silver-plated Copper-covered Steel Conductor • Copper-Tin Composite Shield (100% Coverage)

TFE Teflon Insulation • Unjacketed																			
UL AWM	1671A*	—	50	15.2	2.0	.9	24 AWG	.062	1.57	CT	.085	2.16	50	69.5%	29.5	96.8	500	15.0	49.2
Style 10245 (30V 105°C)			100	30.5	2.5	1.1	(solid)			Composite							1000	22.2	72.8
			500†	152.4	7.5	3.4	.020"			100% Shield							2000	32.8	107.6
			1000†	304.8	14.0	6.4	SPCCS			Coverage							3000	41.2	135.2
							64.2Ω/M'			10.2Ω/M'							5000	54.9	180.1
							210.6Ω/km			33.5Ω/km							7000	66.4	217.9
																	10000	81.2	266.4
																	15000	102.0	334.7
																	18000	113.0	370.8
																	20000	120.0	393.7



Suitable for Outdoor applications.

TFE Teflon Insulation • PVC Jacket (Black or Clear)

UL AWM	1671J*	—	100††	30.5	2.9	1.3	24 AWG	.062	1.57	CT	.127	3.23	50	69.5%	29.5	96.8	500	15.0	49.2
Style 10245 (30V 105°C)			500†	152.4	9.5	4.7	(solid)			Composite							1000	22.2	72.8
			1000†	304.8	17.0	7.7	.020"			100% Shield							2000	32.8	107.6
							SPCCS			Coverage							3000	41.2	135.2
							64.2Ω/M'			10.2Ω/M'							5000	54.9	180.1
							210.6Ω/km			33.5Ω/km							7000	66.4	217.9
																	10000	81.2	266.4
																	15000	102.0	334.7
																	18000	113.0	370.8
																	20000	120.0	393.7



*100 ft. put-up available in Black only.
Suitable for Outdoor applications.

RG-405/U Type • 24 AWG Solid .020" Silver-plated Copper Conductor • Copper-Tin Composite Shield (100% Coverage)

TFE Teflon Insulation • Unjacketed																			
UL AWM	1671B	—	500††	152.4	7.0	3.2	24 AWG	.062	1.57	CT	.085	2.16	50	69.5%	29.5	96.8	500	15.0	49.2
Style 10245 (30V 105°C)			1000††	304.8	13.0	6.0	(solid)			Composite							1000	22.2	72.8
							.020"			100% Shield							2000	32.8	107.6
							SPC			Coverage							3000	41.2	135.2
							25.7Ω/M'			10.2Ω/M'							5000	54.9	180.1
							84.3Ω/km			33.5Ω/km							7000	66.4	217.9
																	10000	81.2	266.4
																	15000	102.0	334.7
																	18000	113.0	370.8
																	20000	120.0	393.7



Suitable for Outdoor applications.

CT = Copper-Tin • DCR = DC Resistance • SPC = Silver-plated Copper • SPCCS = Silver-coated Copper-covered Steel • TFE = Tetra Fluoroethylene

Contact the Belden Customer Service Department for a Comprehensive Connector Cross Reference. **1-800-BELDEN-1**.

*Protected by one or more of U.S. Patent Nos. 4,694,122 and 5,292,001. Patent held in the U.S., Singapore, Australia, Germany, France and England. Patent pending in Japan.

†250 ft. put-up: Exact 3 pieces (maximum), 50 feet minimum length
500 ft. put-up: Exact 5 pieces (maximum), 50 feet minimum length
1000 ft. put-up: Exact 8 pieces (maximum), 50 feet minimum length

††May contain more than one piece. Min. length of any one piece is 25 ft.

Teflon is a Dupont trademark.



Conformable® Coax Cable

50 Ohm Microwave Cables

Description	Part No.	UL NEC/ C(UL) CEC Type	Standard Lengths		Standard Unit Weight		Conductor (stranding) Diameter Nom. DCR	Nominal Core OD		Shielding Materials Nom. DCR	Nominal OD		Nom. Imp. (Ω)	Nom. Vel. of Prop.	Nominal Capacitance		Nominal Attenuation		
			Ft.	m	Lbs.	kg		Inch	mm		Inch	mm			pF/Ft.	pF/m	MHz	dB/100 Ft.	dB/100m

RG-402/U Type • 19 AWG Solid .036" Silver-plated Copper-covered Steel Conductor • Copper-Tin Composite Shield (100% Coverage)

TFE Teflon® Insulation • Unjacketed																			
UL AWM	1673A*	—	50	15.2	3.3	1.5	19 AWG	.116	2.95	CT	.138	3.51	50	69.5%	29.5	96.8	500	8.0	26.2
Style 10245 (30V 105°C)			100	30.5	3.9	1.8	(solid)			Composite							1000	12.0	39.4
			250†	76.2	8.0	3.6	.036"			100% Shield							2000	18.1	59.4
			500	152.4	15.0	6.8	SPCCS			Coverage							3000	22.9	75.1
							20.5Ω/M'			4.5Ω/M'							5000	31.0	101.7
							67.3Ω/km			14.8Ω/km							7000	37.8	124.0
																	10000	46.6	152.9
																	15000	59.1	193.9
																	18000	65.8	215.9
																	20000	70.0	229.7



TFE Teflon Insulation • Black PVC Jacket

UL AWM	1673J*	—	100	30.5	5.1	2.3	19 AWG	.116	2.95	CT	.178	4.52	50	69.5%	29.5	96.8	500	8.0	26.2
Style 10245 (30V 105°C)			500†	152.4	17.5	8.0	(solid)			Composite							1000	12.0	39.4
							.036"			100% Shield							2000	18.1	59.4
							SPCCS			Coverage							3000	22.9	75.1
							20.5Ω/M'			4.5Ω/M'							5000	31.0	101.7
							67.3Ω/km			14.8Ω/km							7000	37.8	124.0
																	10000	46.6	152.9
																	15000	59.1	193.9
																	18000	65.8	215.9
																	20000	70.0	229.7



RG-402/U Type • 19 AWG Solid .036" Silver-plated Copper Conductor • Copper-Tin Composite Shield (100% Coverage)

TFE Teflon Insulation • Unjacketed																			
UL AWM	1673B*	—	100††	30.5	3.9	1.8	19 AWG	.116	2.95	CT	.138	3.51	50	69.5%	29.5	96.8	500	8.0	26.2
Style 10245 (30V 105°C)			500††	76.2	8.0	3.6	(solid)			Composite							1000	12.0	39.4
							.036"			100% Shield							2000	18.1	59.4
							SPC			Coverage							3000	22.9	75.1
							7.9Ω/M'			4.5Ω/M'							5000	31.0	101.7
							25.9Ω/km			14.8Ω/km							7000	37.8	124.0
																	10000	46.6	152.9
																	15000	59.1	193.9
																	18000	65.8	215.9
																	20000	70.0	229.7



RG-401/U Type • 14 AWG Solid .065" Silver-plated Copper Conductor • Copper-Tin Composite Shield (100% Coverage)

TFE Teflon Insulation • Unjacketed																			
UL AWM	1675A*	—	50†	15.2	4.1	1.8	14 AWG	.210	5.33	CT	.246	6.25	50	69.5%	29.6	97.1	400	3.8	12.5
Style 10245 (30V 105°C)			100††	30.5	8.1	3.7	(solid)			Composite							500	4.4	14.4
			250††	76.2	20.3	9.2	.065"			100% Shield							1000	6.8	22.3
			500††	152.4	40.5	18.4	SPC			Coverage							2000	10.4	34.1
							2.5Ω/M'			8.0Ω/M'							3000	13.4	44.0
							8.2Ω/km			26.2Ω/km							5000	18.5	60.7
																	7000	22.8	74.8
																	10000	28.4	93.2
																	15000	36.6	120.1
																	18000	41.0	134.5



CT = Copper-Tin • DCR = DC Resistance • SPCCS = Silver-plated Copper-covered Steel • SPC = Silver-plated Copper • TFE = Tetra Fluoroethylene

Contact the Belden Customer Service Department for a Comprehensive Connector Cross Reference. **1-800-BELDEN-1**.

* Protected by one or more of U.S. Patent Nos. 4,694,122 and 5,292,001. Patent held in the U.S., Singapore, Australia, Germany, France and England. Patent pending in Japan.

† 250 ft. put-up: Exact 3 pieces (maximum), 50 feet minimum length

500 ft. put-up: Exact 5 pieces (maximum), 50 feet minimum length

1000 ft. put-up: Exact 8 pieces (maximum), 50 feet minimum length

†† May contain more than one piece, minimum length of any one piece is 25 ft.

Teflon is a DuPont trademark.



For more information, contact Belden Technical Support: **1-800-BELDEN-1** • www.belden.com

Conformable® Coax Cable

75 Ohm High-Frequency Video Cables

Description	Part No.	UL NEC/ C(UL) CEC Type	Standard Lengths		Standard Unit Weight		Conductor (stranding) Diameter Nom. DCR	Nominal Core OD		Shielding Materials Nom. DCR	Nominal OD		Nom. Imp. (Ω)	Nom. Vel. of Prop.	Nominal Capacitance		Nominal Attenuation		
			Ft.	m	Lbs.	kg		Inch	mm		Inch	mm			pF/Ft.	pF/m	MHz	dB/100 Ft.	dB/100m

29 AWG Solid .011" Silver-coated Copper-covered Steel Conductor • Copper-Tin Composite Shield (100% Coverage)

TFE Teflon® Insulation • Unjacketed

UL AWM	1672A*	—	500†	152.4	7.5	3.4	29 AWG	.062	1.58	CT	.087	2.21	75	69.5%	19.5	64.0	1	1.6	5.3
Style 10245 (30V 105°C)			1000†	304.8	14.0	6.4	(solid) .011"			Composite 100% Shield							10	1.8	5.9
							SCCCS			Coverage							50	4.1	13.5
							205.0Ω/M'			10.0Ω/M'							100	6.5	21.3
							672.4Ω/km			32.8Ω/km							200	9.0	29.5
																	400	12.8	42.0
																	700	18.0	59.1
																	1000	22.1	72.5



TFE Teflon Insulation • PVC Jacket (Black or Clear)

UL AWM	1672J*	—	100††	30.5	3.1	1.4	29 AWG	.062	1.58	CT	.127	3.23	75	69.5%	19.5	64.0	1	1.6	5.3
Style 10245 (30V 105°C)			500††	152.4	9.5	4.3	(solid) .011"			Composite 100% Shield							10	1.8	5.9
			1000†	304.8	17.0	7.7	SCCCS			Coverage							50	4.1	13.5
							205.0Ω/M'			10.0Ω/M'							100	6.5	21.3
							672.6Ω/km			32.8Ω/km							200	9.0	29.5
																	400	12.8	42.0
																	700	18.0	59.1
																	1000	22.1	72.5



*100 ft. put-up available in Clear only.

29 AWG Solid .011" Silver-plated Copper Conductor • Copper-Tin Composite Shield (100% Coverage)

TFE Teflon Insulation • Unjacketed

UL AWM	1672B*	—	100††	30.5	2.5	1.1	29 AWG	.062	1.58	CT	.087	2.21	75	69.5%	19.5	64.0	1	1.6	5.3
Style 10245 (30V 105°C)			500††	152.4	7.5	3.4	(solid) .011"			Composite 100% Shield							10	1.8	5.9
			1000††	304.8	14.0	6.4	SPC			Coverage							50	4.1	13.5
							11.0Ω/M'			10.0Ω/M'							100	6.5	21.3
							36.1Ω/km			32.8Ω/km							200	9.0	29.5
																	400	12.8	42.0
																	700	18.0	59.1
																	1000	22.1	72.5



Non-ferrous design.

CT = Copper Tin • DCR = DC Resistance • SCCC = Silver-coated Copper-covered Steel • SPC = Silver-plated Copper • TFE = Tetra Fluoroethylene

Contact the Belden Customer Service Department for a Comprehensive Connector Cross Reference. **1-800-BELDEN-1**.

* Protected by one or more of U.S. Patent Nos. 4,694,122 and 5,292,001. Patent held in the U.S., Singapore, Australia, Germany, France and England. Patent pending in Japan.

† 250 ft. put-up: Exact 3 pieces (maximum), 50 feet minimum length

500 ft. put-up: Exact 5 pieces (maximum), 50 feet minimum length

1000 ft. put-up: Exact 8 pieces (maximum), 50 feet minimum length

†† May contain more than 1 piece, minimum length of any one piece is 25 ft.

Teflon is a DuPont trademark.



For more information, contact **Belden Technical Support: 1-800-BELDEN-1 • www.belden.com**

Conformable® Coax Cable

Electrical Characteristics

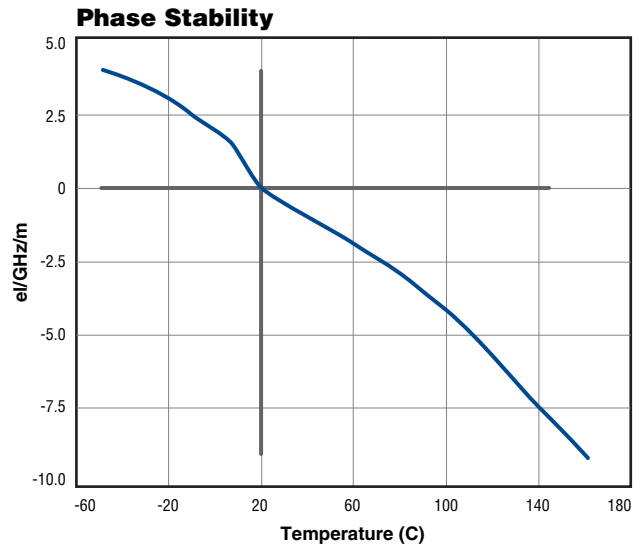
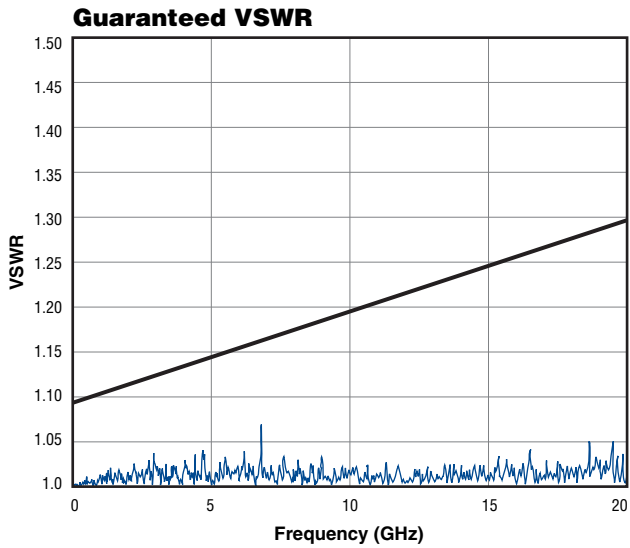
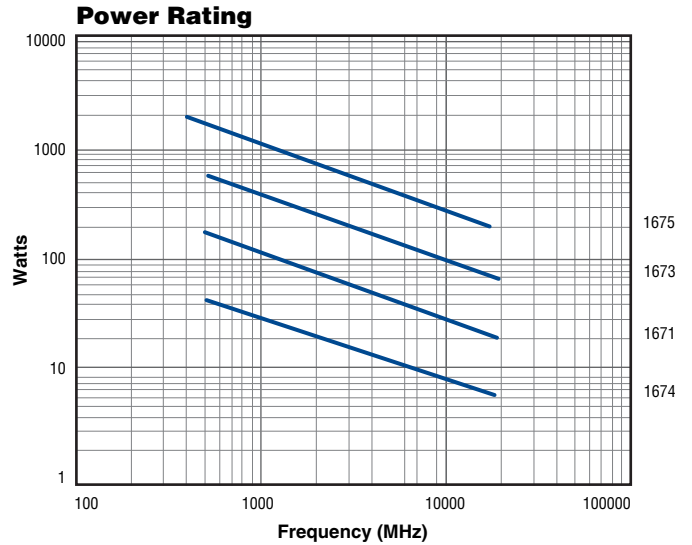
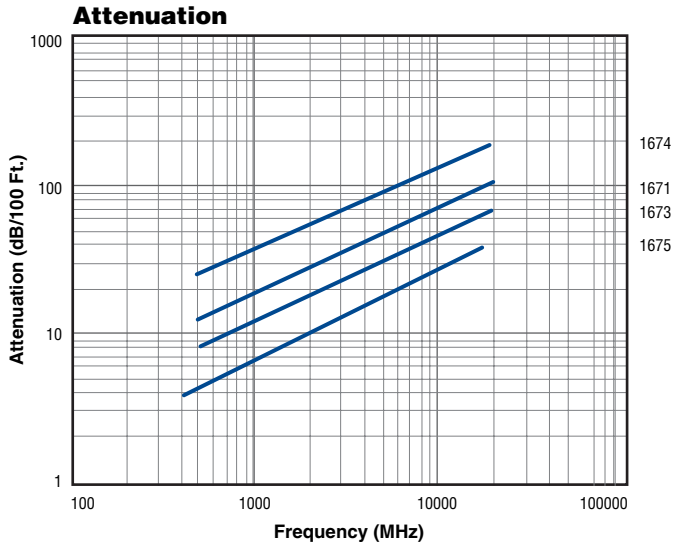

Conformable Coax cable is an alternative to semi-rigid and flexible coax for “black box” applications involving internal, head-end wiring of electronic equipment, delay lines, and high-frequency applications.

MIL-C-17G QPL Cable

50 Ohm Coax

Description	Part No.	UL NEC/ C(UL) CEC Type	Standard Lengths		Standard Unit Weight		Conductor (stranding) Diameter Nom. DCR	Nominal Core OD		Shielding Materials Nom. DCR	Nominal OD		Nom. Imp. (Ω)	Nom. Vel. of Prop.	Nominal Capacitance		Nominal Attenuation		
			Ft.	m	Lbs.	kg		Inch	mm		Inch	mm			pF/Ft.	pF/m	MHz	dB/100 Ft.	dB/100m

30 AWG Stranded (7x38) .012" Silver-plated Copper-covered Steel Conductor • Silver-plated Copper Braid Shield (96% Coverage)

TFE Teflon® Insulation • White FEP Jacket																				
200°C	83265	—	100†	30.5	.8	.4	30 AWG	.033	.84	SPC Braid	.071	1.80	50	69.5%	29.0	95.1	1	2.6	8.5	
VW-1			500†	152.4	4.0	1.6	(7x38)			96% Shield								10	5.6	18.4
			1000†	304.8	6.0	3.2	.012"			Coverage									50	10.5
							SPCCS			14.6Ω/M'								100	14.0	45.9
							244.0Ω/M'			47.9Ω/km								200	19.0	62.3
							801.0Ω/km											400	28.0	91.9
																		700	37.0	121.4
																		900	42.5	139.4
																		1000	46.0	150.9

M17/169-00001 (RG-178B/U). Non-SWR swept version of RG-178.

26 AWG Stranded (7x34) .020" Silver-plated Copper-covered Steel Conductor • Silver-plated Copper Braid Shield (95% Coverage)

TFE Teflon Insulation • White FEP Jacket																				
200°C	83284	—	100†	30.5	1.2	.5	26 AWG	.058	1.47	SPC Braid	.098	2.49	50	69.5%	29.0	95.1	1	1.2	3.9	
VW-1			500†	152.4	5.5	2.7	(7x34)			95% Shield								10	2.7	8.9
			1000†	304.8	11.0	5.0	.020"			Coverage									50	5.6
							SPCCS			6.5Ω/M'								100	8.3	27.2
							84.1Ω/M'			21.3Ω/km								200	12.0	39.4
							275.9Ω/km											400	17.5	57.4
																		700	23.7	77.8
																		900	27.3	89.6
																		1000	29.0	95.1

M17/172-00001 (RG-316/U). Non-SWR swept version of RG-316.

TFE Teflon Insulation • Brown FEP Jacket																				
200°C	84316	—	100†	30.5	1.2	.5	26 AWG	.058	1.47	SPC Braid	.098	2.49	50	69.5%	29.0	95.1	1	1.2	3.9	
VW-1			500†	152.4	5.5	2.5	(7x34)			95% Shield								10	2.7	8.9
			1000†	304.8	11.0	5.0	.020"			Coverage									50	5.6
							SPCCS			6.5Ω/M'								100	8.3	27.2
							84.1Ω/M'			21.3Ω/km								200	12.0	39.4
							275.9Ω/km											400	17.5	57.4
																		700	23.7	77.8
																		900	27.3	89.6
																		1000	29.0	95.1

M17/113-RG316

22 AWG Stranded (27x36) .030" Tinned Copper Conductor • Tinned Copper Braid Shield (95% Coverage)

Polyethylene Insulation • Black Non-contaminating PVC Jacket																				
UL AWM	9252	NEC:	1000	304.8	18.0	8.2	22 AWG	.096	2.44	TC Braid	.160	4.06	50	66%	30.8	101.0	1	.4	1.3	
Style 1354		CMX					(27x36)			Shield								10	1.7	5.6
(30V 80°C)		CEC:					.030"			95% Shield								50	4.5	14.8
VW-1	CMX					TC			Coverage								100	7.0	23.0	
							17.1Ω/M'			5.2Ω/M'							200	11.0	36.1	
							56.1Ω/km			17.1Ω/km							400	16.5	54.1	
																	700	23.5	77.1	
																	900	27.3	89.6	
																	1000	29.0	95.1	

M17/157-00001 (RG-122/U). Non-SWR swept version of RG-122.

DCR = DC Resistance • FEP = Fluorinated Ethylene Propylene • SPC = Silver-plated Copper • SPCCS = Silver-plated Copper-covered Steel • TC = Tinned Copper • TFE = Tetra Fluoroethylene

Contact the Belden Customer Service Department for a Comprehensive Connector Cross Reference. **1-800-BELDEN-1**.

†May contain more than one piece, minimum length of any one piece is 25 ft.

Teflon is a DuPont trademark.





For more information, contact Belden Technical Support: **1-800-BELDEN-1** • www.belden.com

MIL-C-17G QPL Cable

50 Ohm Coax

Description	Part No.	UL NEC/ C(UL) CEC Type	Standard Lengths		Standard Unit Weight		Conductor (stranding) Diameter Nom. DCR	Nominal Core OD		Shielding Materials Nom. DCR	Nominal OD		Nom. Imp. (Ω)	Nom. Vel. of Prop.	Nominal Capacitance		Nominal Attenuation		
			Ft.	m	Lbs.	kg		Inch	mm		Inch	mm			pF/Ft.	pF/m	MHz	dB/100 Ft.	dB/100m



20 AWG Stranded (19x33) .035" Tinned Copper Conductor • Tinned Copper Braid Shield (95% Coverage)

Polyethylene Insulation • Black Non-contaminating PVC Jacket																			
85°C	9203	—	500	152.4	12.5	5.7	20 AWG (19x33) .035" TC 10.8Ω/M' 35.4Ω/km	.116	2.95	TC Braid 95% Shield Coverage 4.1Ω/M' 13.5Ω/km	.195	4.95	50	66%	30.8	101.0	1	.4	1.3
			1000	304.8	25.0	12.3											10	1.4	4.6
																			
M17/28-RG58																			
85°C	8262	—	U-500	U-152.4	13.5	6.1	20 AWG (19x33) .035" TC 10.8Ω/M' 35.4Ω/km	.115	2.92	TC Braid 95% Shield Coverage 4.1Ω/M' 13.5Ω/km	.195	4.95	50	66%	30.8	101.0	1	.4	1.3
			500	152.4	12.5	5.7											10	1.4	4.6
																			
M17/155-00001 (RG-58C/U). Non-SWR swept version of RG-58.																			

19 AWG Solid .034" Silver-coated Copper Conductor • Double Silver-coated Copper Braid Shield (95% Coverage)

Polyethylene Insulation • Black Non-contaminating PVC Jacket																			
UL AWM Style 1354 (30V 60°C)	9273	NEC:	100	30.5	4.7	2.1	19 AWG (solid) .034" SCC 8.8Ω/M' 28.9Ω/km	.117	2.97	(2) SCC Braids 95% Shield Coverage 2.5Ω/M' 8.2Ω/km	.212	5.39	50	66%	30.8	101.0	1	.4	1.3
		CMX	U-500	U-152.4	20.0	9.1											10	1.2	3.9
																			
M17/167-00001 (RG-223/U). Non-SWR swept version of RG-223.																			

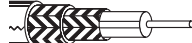
18 AWG Solid .037" Silver-coated Copper-covered Steel Conductor • Double Silver-coated Copper Braid Shield (96% Coverage)

Plenum • TFE Teflon® Insulation • Tinted Brown FEP Jacket																			
200°C VW-1	84142	NEC:	100	30.5	5.0	2.3	18 AWG (solid) .037" SCCCS 19.3Ω/M' 63.3Ω/km	.116	2.95	(2) SCC Braids 96% Shield Coverage 2.3Ω/M' 7.5Ω/km	.195	4.95	50	70%	29.0	95.1	10	1.1	3.6
		CMP	500†	152.4	22.5	10.2											50	2.6	8.5
																			
M17/60-RG142																			
200°C VW-1	83242	NEC:	100†	30.5	5.3	2.4	18 AWG (solid) .037" SCCCS 19.3Ω/M' 63.3Ω/km	.116	2.95	(2) SCC Braids 96% Shield Coverage 2.3Ω/M' 7.5Ω/km	.195	4.95	50	70%	29.0	95.1	10	1.1	3.6
		CMP	500†	152.4	22.5	10.2											50	2.6	8.5
																			
M17/158-00001 (RG-142B/U). Non-SWR swept version of RG-142.																			

18 AWG Solid .037" Silver-coated Copper-covered Steel Conductor • Silver-coated Copper Braid Shield (95% Coverage)

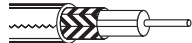
Plenum • TFE Teflon Insulation • Tinted Brown FEP Jacket																			
200°C VW-1	84303	NEC:	500†	152.4	16.5	7.5	18 AWG (solid) .037" SCCCS 16.3Ω/M' 53.5Ω/km	.116	2.95	SCC Braid Shield 95% Shield Coverage 4.3Ω/M' 14.1Ω/km	.170	4.31	50	70%	29.0	95.1	10	1.1	3.6
		CL2P	1000†	304.8	32.0	14.5											50	2.6	8.5
																			
M17/111-RG303																			

DCR = DC Resistance • FEP = Fluorinated Ethylene Propylene • SCC = Silver-coated Copper • SCCCS = Silver-coated Copper-covered Steel • TC = Tinned Copper • TFE = Tetra Fluoroethylene

Contact the Belden Customer Service Department for a Comprehensive Connector Cross Reference. **1-800-BELDEN-1**.

†May contain more than one piece, minimum length of any 1 piece is 25 feet.

Teflon is a DuPont trademark.



For more information, contact **Belden Technical Support: 1-800-BELDEN-1 • www.belden.com**

MIL-C-17G QPL Cable

50 Ohm Coax

Description	Part No.	UL NEC/ C(UL) CEC Type	Standard Lengths		Standard Unit Weight		Conductor (stranding) Diameter Nom. DCR	Nominal Core OD		Shielding Materials Nom. DCR	Nominal OD		Nom. Imp. (Ω)	Nom. Vel. of Prop.	Nominal Capacitance		Nominal Attenuation		
			Ft.	m	Lbs.	kg		Inch	mm		Inch	mm			pF/Ft.	pF/m	MHz	dB/100 Ft.	dB/100m

15.5 AWG Solid .056" Silver-plated Copper Conductor • Double Silver-plated Copper Braid Shield (95% Coverage)

Polyethylene Insulation • Black Non-contaminating PVC Jacket

85°C	9861	—	1000	304.8	91.0	41.4	15.5 AWG (solid)	.185	4.70	(2) SPC Braids	.332	8.43	50	66%	30.8	101.0	1	.3	.9
																			
.056"																			
95% Shield Coverage																			
3.3Ω/M'																			
10.8Ω/km																			
1.1Ω/M'																			
3.6Ω/km																			
10																			
50																			
100																			
200																			
400																			
700																			
900																			
1000																			
21.5																			
70.5																			

M17/162-00001 (RG-212/U). Non-SWR swept version of RG-212.

13 AWG Stranded (7x21) .089" Bare Copper Conductor • Bare Copper Braid Shield (96% Coverage)

Polyethylene Insulation • Black Non-contaminating PVC Jacket

UL AWM Style 1354 (30V 60°C)	8267	NEC: CMX	500	152.4	59.5	27.0	13 AWG (7x21)	.285	7.24	BC Braid	.405	10.29	50	66%	30.8	101.0	1	.2	.6
																			
.089"																			
96% Shield Coverage																			
1.2Ω/M'																			
3.9Ω/km																			
1.7Ω/M'																			
5.6Ω/km																			
10																			
50																			
100																			
200																			
400																			
700																			
900																			
1000																			
4000																			
21.5																			
70.5																			

M17/163-00001 (RG-213/U). Non-SWR swept version of RG-213.

13 AWG Stranded (7x21) .089" Silver-plated Copper Conductor • Double Silver-plated Copper Braid Shield (97% Coverage)

Polyethylene Insulation • Black Non-contaminating PVC Jacket

UL AWM Style 1354 (30V 60°C)	8268	NEC: CMX	500	152.4	70.5	32.0	13 AWG (7x21)	.285	7.24	(2) SPC Braids	.425	10.80	50	66%	30.8	101.0	1	.2	.6
																			
.089"																			
97% Shield Coverage																			
1.7Ω/M'																			
5.6Ω/km																			
.7Ω/M'																			
2.3Ω/km																			
10																			
50																			
100																			
200																			
400																			
700																			
900																			
1000																			
4000																			
20.0																			
65.6																			

M17/164-00001 (RG-214/U). Non-SWR swept version of RG-214.

BC = Bare Copper • DCR = DC Resistance • SPC = Silver-plated Copper

Contact the Belden Customer Service Department for a Comprehensive Connector Cross Reference. **1-800-BELDEN-1**.

MIL-C-17G QPL Cable

75 Ohm Coax

Description	Part No.	UL NEC/ C(UL) CEC Type	Standard Lengths		Standard Unit Weight		Conductor (stranding) Diameter Nom. DCR	Nominal Core OD		Shielding Materials Nom. DCR	Nominal OD		Nom. Imp. (Ω)	Nom. Vel. of Prop.	Nominal Capacitance		Nominal Attenuation		
			Ft.	m	Lbs.	kg		Inch	mm		Inch	mm			pF/Ft.	pF/m	MHz	dB/100 Ft.	dB/100m

30 AWG Stranded (7x38) .012" Silver-plated Copper-covered Steel Conductor • Silver-plated Copper Braid Shield (94% Coverage)

TFE Teflon® Insulation • Tinted Brown FEP Jacket																					
200°C	83264	—	100†	30.5	1.2	.5	30 AWG	.062	1.58	SPC Braid	.100	2.54	75	69.5%	19.5	64.0	1	3.0	9.8		
VW-1			500†	152.4	5.5	2.5	(7x38)			94% Shield								10	5.3	17.4	
			1000†	304.8	11.0	5.0	.012"			Coverage									50	8.5	27.9
								SPCCS			8.5Ω/M'								100	10.0	32.8
									244.0Ω/M'									200	12.5	41.0	
									801.0Ω/km									400	16.0	52.5	
										27.4Ω/km								700	19.7	64.6	
																		900	22.3	73.2	
																		1000	24.0	78.7	

M17/94-RG179

23 AWG Solid .023" Bare Copper-covered Steel Conductor • Bare Copper Braid Shield (95% Coverage)

Polyethylene Insulation • Black Non-contaminating PVC Jacket																					
60°C	9204	NEC:	500	152.4	18.0	8.2	23 AWG	.146	3.71	BC Braid	.241	6.12	75	66%	20.5	67.3	1	.6	2.0		
VW-1		CMH	U-1000	U-304.8	38.0	17.3	(solid)			95% Shield								10	1.1	3.6	
		CEC:	1000	304.8	39.0	17.7	.023"			Coverage									50	2.4	7.9
		CMH FT1					BCCS			2.6Ω/M'									100	3.4	11.2
									47.0Ω/M'										200	4.9	16.1
									154.2Ω/km										400	7.0	23.0
										8.5Ω/km									700	9.7	31.8
																			900	11.1	36.4
																			1000	12.0	39.4

M17/29-RG59

18 AWG Stranded (7x26) .048" Tinned Copper Conductor • Bare Copper Braid Shield (97% Coverage)

Polyethylene Insulation • Black Non-contaminating PVC Jacket																					
60°C	9212	NEC:	1000	304.8	105.0	47.7	18 AWG	.285	7.24	BC Braid	.405	10.29	75	66%	20.5	67.3	1	.2	.7		
VW-1		CMH					(7x26)			97% Shield								10	.7	2.3	
		CEC:					.048"			Coverage									50	1.3	4.3
		CMH FT1					TC			1.2Ω/M'									100	2.0	6.6
									6.1Ω/M'										200	2.9	9.5
									20.0Ω/km										400	4.2	13.8
										3.9Ω/km									700	5.8	19.0
																			900	6.9	22.6
																			1000	7.2	23.6

M17/6-RG11

18 AWG Stranded (7x26) .048" Tinned Copper Conductor • Double Bare Copper Braid Shield (95% Coverage)

Polyethylene Insulation • Black Non-contaminating PVC Jacket																					
60°C	9850	NEC:	1000	304.8	131.0	59.5	18 AWG	.285	7.24	(2) BC	.425	10.80	75	66%	20.5	67.3	1	.2	.6		
VW-1		CMH					(7x26)			Braids								10	.7	2.2	
		CEC:					.048"			95% Shield									50	1.3	4.3
		CMH FT1					TC			Coverage									100	2.0	6.6
									6.1Ω/M'										200	2.9	9.5
									20.0Ω/km										400	4.2	13.8
										2.6Ω/km									700	5.8	19.0
																			900	6.8	22.3
																			1000	7.1	23.3

M17/77-RG216

BC = Bare Copper • BCCS = Bare Copper-covered Steel • DCR = DC Resistance • SPCCS = Silver-plated Copper-covered Steel • TC = Tinned Copper • TFE = Tetra Fluoroethylene

Contact the Belden Customer Service Department for a Comprehensive Connector Cross Reference. **1-800-BELDEN-1**.

†May contain more than one piece, minimum length of any 1 piece is 25 feet.

Teflon is a DuPont trademark.

MIL-C-17G QPL Cable

93 Ohm, 95 Ohm and 125 Ohm Coax

Description	Part No.	UL NEC/ C(UL) CEC Type	Standard Lengths		Standard Unit Weight		Conductor (stranding) Diameter Nom. DCR	Nominal Core OD		Shielding Materials Nom. DCR	Nominal OD		Nom. Imp. (Ω)	Nom. Vel. of Prop.	Nominal Capacitance		Nominal Attenuation		
			Ft.	m	Lbs.	kg		Inch	mm		Inch	mm			pF/Ft.	pF/m	MHz	dB/100 Ft.	dB/100m

93 Ohm • 22 AWG Solid .025" Bare Copper-covered Steel Conductor • Bare Copper Braid Shield (95% Coverage)

Semi-solid Polyethylene Insulation • Black Non-contaminating PVC Jacket																			
UL AWM Style 1354 (30V 60°C)	9862	NEC: CMX CEC: CMX	1000	304.8	37.0	16.8	22 AWG (solid) .025" BCCS 41.2Ω/M' 135.2Ω/km	.146	3.71	BC Braid 95% Shield Coverage 2.9Ω/M' 9.5Ω/km	.242	6.15	93	84%	13.5	44.3	1	.3	1.0
																	10	.9	3.0
																	50	1.9	6.2
																	100	2.7	8.9
																	200	3.8	12.5
																	400	5.3	17.4
																	700	7.3	24.0
																	900	8.2	26.9
																	1000	8.7	28.5

M17/30-RG62

93 Ohm • 22 AWG Solid .025" Bare Copper-covered Steel Conductor • BC Outer Braid/TC Inner Braid Shield (95% Coverage)

Semi-solid Polyethylene Insulation • Black Polyethylene Jacket																			
85°C	9169	—	1000	304.8	46.0	20.9	22 AWG (solid) .025" BCCS 41.2Ω/M' 135.2Ω/km	.146	3.71	(2) Braids Inner: BC Outer: TC 95% Shield Coverage 1.5Ω/M' 4.9Ω/km	.245	6.22	93	84%	13.5	44.3	1	.3	1.0
																	10	.9	3.0
																	50	1.9	6.2
																	100	2.7	8.9
																	200	3.8	12.5
																	400	5.3	17.4
																	700	7.3	24.0
																	900	8.2	26.9
																	1000	8.7	28.5

M17/90-RG71

95 Ohm • 30 AWG Stranded (7x38) .012" Silver-plated Copper-covered Steel Conductor • Silver-plated Copper Braid Shield (91% Coverage)

TFE Teflon® Insulation • Tinted Brown FEP Jacket																			
200°C VW-1	83266	—	1000†	304.8	20.0	9.1	30 AWG (7x38) .012" SPCCS 244.0Ω/M' 801.0Ω/km	.102	2.60	SPC Braid 91% Shield Coverage 6.5Ω/M' 21.3Ω/km	.141	3.58	95	69.5%	15.0	49.2	1	2.4	7.9
																	10	3.3	10.8
																	50	4.6	15.1
																	100	5.7	18.7
																	200	7.6	24.9
																	400	10.7	35.1
																	700	14.9	48.9
																	900	15.9	52.2
																	1000	17.0	55.8

M17/95-RG180

125 Ohm • 22 AWG Solid .025" Bare Copper-covered Steel Conductor • Bare Copper Braid Shield (97% Coverage)

Semi-solid Polyethylene Insulation • Black Non-contaminating PVC Jacket																			
60°C	9857	NEC: CMH CEC: CMH FT1	1000	304.8	94.0	42.6	22 AWG (solid) .025" BCCS 41.2Ω/M' 135.2Ω/km	.285	7.24	BC Braid 97% Shield Coverage 1.2Ω/M' 3.9Ω/km	.405	10.29	125	84%	9.7	31.8	1	.2	1.0
																	10	.5	1.6
																	50	1.1	3.6
																	100	1.5	4.9
																	200	2.3	7.5
																	400	3.4	11.2
																	700	4.6	15.1
																	900	5.5	18.0
																	1000	5.8	19.0

M17/31-RG63

BC = Bare Copper • BCCS = Bare Copper-covered Steel • DCR = DC Resistance • FEP = Fluorinated Ethylene Propylene • SPC = Silver-plated Copper • SPCCS = Silver-plated Copper-covered Steel • TC = Tinned Copper • TFE = Tetra Fluoroethylene

Contact the Belden Customer Service Department for a Comprehensive Connector Cross Reference. **1-800-BELDEN-1**.

† May contain more than 1 piece, minimum length of any one piece is 25 feet.

Teflon is a DuPont trademark.



MIL-C-17G QPL Cable

Twinax

Description	Part No.	UL NEC/ C(UL) CEC Type	Standard Lengths		Standard Unit Weight		Conductor (stranding) Diameter Nom. DCR	Nominal Core OD		Shielding Materials Nom. DCR	Nominal OD		Nom. Imp. (Ω)	Nom. Vel. of Prop.	Nominal Capacitance		Nominal Attenuation		
			Ft.	m	Lbs.	kg		Inch	mm		Inch	mm			pF/Ft.	pF/m	MHz	dB/100 Ft.	dB/100m

Twinax • 24 AWG Stranded (19x36) .024" Silver-coated High-Strength Copper Alloy Conductor • SCHSCA Braid Shield (93% Coverage)

TFE Teflon® Insulation • Blue PFA Jacket (Color Code: White, Blue)																			
200°C	81553	—	500†	152.4	9.0	4.1	24 AWG (19x36)	.084	2.13	SCHSCA	.129	3.28	77	70%	24.0	78.7	1	1.2	3.9
			1000†	304.8	16.0	7.3	.024"			93% Shield Coverage							10	4.0	13.1
							SCHSCA			7.3Ω/M'							50	9.2	30.2
							24.0Ω/M'			24.0Ω/km							100	13.0	42.7
							78.7Ω/km										200	18.4	60.4
																	400	26.1	85.6
																	700	34.6	113.5
																	900	39.3	128.9
																	1000	41.4	135.8

M17/176-00002

Twinax • 20 AWG Stranded (7x28) .038" Tinned Copper Conductor • Tinned Copper Braid Shield (85% Coverage)

Polyethylene Insulation • Black Non-contaminating PVC Jacket (One conductor has bare strand for ID)																			
85°C	9859	—	1000	304.8	33.0	15.0	20 AWG (7x28)	.158	4.01	TC Braid	.235	5.97	78	66%	19.7	64.6	1	.7	2.3
							.038"			85% Shield Coverage							10	2.3	7.5
							TC			5.3Ω/M'							50	5.2	17.1
							9.5Ω/M'			17.4Ω/km							100	7.5	24.6
							31.2Ω/km										200	11.0	36.1
																	400	16.0	52.5

M17/45-RG108

DCR = DC Resistance • PFA = Perfluoroalkoxy • SCHSCA = Silver-coated High-strength Copper Alloy • TC = Tinned Copper • TFE = Tetra Fluoroethylene

Contact the Belden Customer Service Department for a Comprehensive Connector Cross Reference. **1-800-BELDEN-1**.

†Spools may contain more than one piece. Minimum length of any one piece is 50 ft. Length may vary ±10% from length shown for spools or reels and ±5% UnReel® cartons.

 Not RoHS compliant at time of printing. Please check with Belden Technical Support for current compliance information at 1-800-BELDEN-1.

Teflon is a DuPont trademark.



For more information, contact Belden Technical Support: **1-800-BELDEN-1** • www.belden.com

Special Audio, Communication and Instrumentation Cable

Miniature Instrumentation and Low Triboelectric Noise Coax

Description	Part No.	UL NEC/ C(UL) CEC Type	Standard Lengths		Standard Unit Weight		Conductor (stranding) Diameter Nom. DCR	Nominal Core OD		Shielding Materials Nom. DCR	Nominal OD		Nom. Imp. (Ω)	Nom. Vel. of Prop.	Nominal Capacitance		Nominal Attenuation		
			Ft.	m	Lbs.	kg		Inch	mm		Inch	mm			pF/Ft.	pF/m	MHz	dB/100 Ft.	dB/100m

Miniature • 28 AWG Solid .013" Tinned Copper Conductor • Bare Copper Braid Shield (90% Coverage)

Polypropylene Insulation • Black PVC Jacket

105°C VW-1	8700	NEC: CMH CEC: CMH FT1	250	76.2	.8	.3	28 AWG (solid) .013" TC 66.9Ω/M' 219.5Ω/km	.023	.58	BC Braid 90% Shield Coverage 28.7Ω/M' 94.2Ω/km	.054	1.37	32	66%	55.2	181.1	1	2.5	8.2
																	10	7.7	25.3
																	50	17.2	56.4
																	100	24.5	80.4
																	200	34.8	114.2
																	400	50.0	164.4
																	700	66.0	216.5
																	900	75.0	246.1
																	1000	79.0	259.2

Low Noise • RG-174/U Type • 26 AWG Stranded (7x34) .019" Bare Copper-covered Steel Conductor • TC Braid Shield (90% Coverage)

Polyethylene Insulation • Conductive Layer • Black PVC Jacket

60°C	9239	—	100	30.5	1.0	.5	26 AWG (7x34) .019" BCCS 97.0Ω/M' 318.3Ω/km	.044	1.12	TC Braid 90% Shield Coverage 14.0Ω/M' 45.9Ω/km	.101	2.57	50	62%	38	125	—	—	—
			500	152.4	4.5	2.0													
			1000	304.8	8.0	3.6													

5mV peak-to-peak max.
Not recommended for RF use.

Low Noise • RG-59/U Type • 22 AWG Solid .025" Bare Copper-covered Steel Conductor • Bare Copper Braid Shield (93% Coverage)

Polyethylene Insulation • Conductive Layer • Black PVC Jacket

75°C VW-1	9224	—	U-500	U-152.4	19.5	8.9	22 AWG (solid) .025" BCCS 54.0Ω/M' 177.0Ω/km	.146	3.71	BC Braid 93% Shield Coverage 2.5Ω/M' 8.2Ω/km	.242	6.15	75	65%	22	72	—	—	—
			1000	304.8	39.0	17.7													

5mV peak-to-peak max.
Not recommended for RF use.

Low Noise • RG-58/U Type • 22 AWG Stranded (7x30) .030" TC Conductor • Duobond® II + TC Braid Shield (95% Coverage)

Polyethylene Insulation • Conductive Layer • Black PVC Jacket

80°C VW-1	9223	—	100	30.5	3.4	1.5	22 AWG (7x30) .030" TC 10.8Ω/M' 35.4Ω/km	.112	2.85	Duobond II* + 95% TC Braid 100% Shield Coverage 4.1Ω/M' 13.5Ω/km	.195	4.95	50	56%	37	122	—	—	—
			500	152.4	12.0	5.4													
			1000	304.8	24.0	10.9													

8mV peak-to-peak max.
Not recommended for RF use.

BC = Bare Copper • BCCS = Bare Copper-covered Steel • DCR = DC Resistance • TC = Tinned Copper

Contact the Belden Customer Service Department for a Comprehensive Connector Cross Reference. **1-800-BELDEN-1**.

*Duobond II = Bonded Duofoil® (100% coverage) + aluminum braid (67% coverage).

Computer and Instrumentation Cable

50 Ohm Ethernet® Coax

Description	Part No.	UL NEC/ C(UL) CEC Type	Standard Lengths		Standard Unit Weight		Conductor (stranding) Diameter Nom. DCR	Nominal Core OD		Shielding Materials Nom. DCR	Nominal OD		Nom. Imp. (Ω)	Nom. Vel. of Prop.	Nominal Capacitance		Nominal Attenuation		
			Ft.	m	Lbs.	kg		Inch	mm		Inch	mm			pF/Ft.	pF/m	MHz	dB/ 100 Ft.	dB/ 100m

Thinnet 10Base2 Ethernet • 20 AWG Stranded (19x32) .037" Conductor • Duobond® II + Overall TC Braid Shield (93% Coverage)

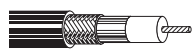
Non-plenum • Foam Polyethylene Insulation • Gray PVC Jacket																				
 <p>UL AWM Style 1354 (30V 60°C)</p>	9907	NEC:	500	152.4	12.5	5.7	20 AWG (19x32)	.102	2.59	Duobond II* + 93%	.185	4.70	50	80%	25.4	83.3	1	.4	1.4	
		CL2	U-1000	U-304.8	24.0	10.9	.037"			TC Braid								10	1.3	4.3
		CM	1000	304.8	23.0	10.4				5.8Ω/M'								50	2.9	9.5
		CEC:	1640	500.0	41.0	18.6	TC			19.0Ω/km								100	4.2	13.8
		CM	2500	762.0	62.5	28.4	8.8Ω/M'											200	6.1	20.0
		CM	3280	1000.0	82.0	37.3	28.9Ω/km											400	8.9	29.2
<p>RG-58A/U Type DEC Part No. 17-01248-00</p>																	700	12.1	39.7	
																	900	13.9	45.6	
																	1000	14.8	48.6	

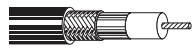
Plenum • Foam FEP Insulation • Gray Fluorocopolymer Jacket																				
 <p>150°C</p>	89907	NEC:	500	152.4	11.0	5.0	20 AWG (19x32)	.095	2.41	Duobond II* + 93%	.160	4.06	50	80%	25.4	83.3	1	.4	1.4	
		CMP	U-1000†	U-304.8	22.0	10.0	.037"			TC Braid								10	1.3	4.3
		CL2P	2500†	762.0	60.0	27.3				5.8Ω/M'								50	2.9	9.5
		CEC:					TC			19.0Ω/km								100	4.2	13.7
		CMP FT6					8.8Ω/M'											200	6.1	20.0
							28.9Ω/km											400	9.2	30.2
<p>RG-58A/U Type DEC Part No. 17-01246-00. Suitable for Outdoor applications.</p>																	700	12.9	42.3	
																	900	15.0	49.2	
																	1000	16.0	52.5	

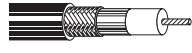
Plenum • FPFA Insulation • Natural Flamarrest® Jacket																				
 <p>75°C</p>	82907	NEC:	500†	152.4	11.0	5.0	20 AWG (19x32)	.095	2.41	Duobond II* + 93%	.160	4.06	50	80%	25.4	83.3	1	.4	1.4	
		CMP	U-1000††	U-304.8	23.0	10.5	.037"			TC Braid								10	1.3	4.3
		CL2P	1000†	304.8	22.0	10.0				5.8Ω/M'								50	2.9	9.5
		CEC:	2500†	762.0	57.5	26.1	TC			19.0Ω/km								100	4.2	13.7
		CMP FT6					8.8Ω/M'											200	6.1	20.0
							28.9Ω/km											400	9.2	30.2
<p>RG-58A/U Type</p>																	700	12.9	42.3	
																	900	15.0	49.2	
																	1000	16.0	52.5	

Thicknet 10Base5 Ethernet • 12 AWG Solid .086" Bare Copper Conductor • Duobond IV Quad Shield (100% Coverage)

Non-plenum • Foam Polyethylene Insulation • Yellow PVC Jacket																				
 <p>UL AWM Style 1478 (30V 60°C)</p>	9880	NEC:	500	152.4	66.0	30.0	12 AWG (solid)	.243	6.17	Duobond IV* + 94% TC Braid + Duofoil®	.405	10.29	50	78%	26.0	85.3	1	.2	.6	
		CL2	1000	304.8	131.0	59.5	.086"			+ 90% TC Braid								5	.4	1.2
		CM	1640	500.0	219.8	99.7				+ Duofoil								10	.5	1.7
		CEC:					BC			1.4Ω/M'								50	1.2	3.9
		CM					1.4Ω/M'			4.7Ω/km								100	1.7	5.6
																		200	2.6	8.4
<p>DEC Part No. 17-00451-00 Ring-band stripes marked every 2.5 meters to aid users in tap placement.</p>																	400	3.9	12.8	
																	700	5.5	18.1	
																	900	6.5	21.3	
																	1000	6.9	22.6	

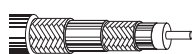
Plenum • Foam FEP Insulation • Orange Fluorocopolymer Jacket																				
 <p>150°C</p>	89880	NEC:	1000	304.8	134.0	60.9	12 AWG (solid)	.245	6.22	Duobond IV* + 90% TC Braid + Duofoil	.375	9.53	50	78%	26.0	85.3	1	.2	.6	
		CL2P	1640†	500.0	224.7	102.1	.086"			+ 90% TC Braid								5	.4	1.2
		CMP					BC			1.4Ω/M'								10	.5	1.7
		CEC:					1.4Ω/M'			4.7Ω/km								50	1.2	3.8
		CMP FT6																100	1.7	5.4
																		200	2.5	8.0
<p>DEC Part No. 17-00324-00 Ring-band stripes marked every 2.5 meters to aid users in tap placement. Suitable for Outdoor and Direct Burial applications.</p>																	400	3.8	12.5	
																	700	5.6	18.4	
																	900	6.8	22.3	
																	1000	7.2	23.6	

BC = Bare Copper • DCR = DC Resistance • FEP = Fluorinated Ethylene Propylene • FPFA = Foam Perfluoroalkoxy • TC = Tinned Copper

Contact the Belden Customer Service Department for a Comprehensive Connector Cross Reference. **1-800-BELDEN-1**.

For cable manufactured to latest government revision or other MIL-SPEC requirements, please contact your nearest Belden Regional Sales Office.

* Duobond II = Bonded Duofoil® (100% coverage) + aluminum braid (67% coverage).

Duobond IV = Bonded Duofoil (100% coverage) + aluminum braid (67% coverage) + Duofoil (100% coverage) + aluminum braid (46% coverage).

† Final put-up length may vary from length shown ±10% for spools and reels, ±5% for UnReel® cartons.

†† Length may vary -0/+10%.

Computer and Instrumentation Cable

75 Ohm Coax

Description	Part No.	UL NEC/ C(UL) CEC Type	Standard Lengths		Standard Unit Weight		Conductor (stranding) Diameter Nom. DCR	Nominal Core OD		Shielding Materials Nom. DCR	Nominal OD		Nom. Imp. (Ω)	Nom. Vel. of Prop.	Nominal Capacitance		Nominal Attenuation		
			Ft.	m	Lbs.	kg		Inch	mm		Inch	mm			pF/Ft.	pF/m	MHz	dB/ 100 Ft.	dB/ 100m

75 Ohm • 30 AWG Stranded (7x38) .012" Silver-plated Copper-covered Steel Conductor • Silver-plated Copper Braid Shield (95% Coverage)

TFE Teflon® Insulation • White TFE Tape Jacket

200°C	83267	—	100†	30.5	1.9	.9	30 AWG (7x38) .012" SPCCS 244.0Ω/M' 801.0Ω/km	.063	1.60	SPC Braid 95% Shield Coverage 8.6Ω/M' 28.2Ω/km	.103	2.62	75	69.5%	19.5	64.0	1	3.0	9.8
VW-1			1000†	304.8	11.0	5.0											10	5.3	17.4
																			
RG-187A/U Type • MIL-C-17D																			

75 Ohm • Dual RG-59/U Type • 23 AWG Solid .023" Bare Copper-covered Steel Conductors • Bare Copper Braid Shield (95% Coverage)

Flame-retardant Semi-foam Polyethylene Insulation • Black PVC Jacket

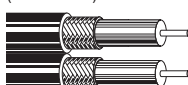
UL AWM Style 20063 (300V 80°C)	9555	NEC:	500	152.4	38.5	17.5	23 AWG (solid) .023" BCCS 50.0Ω/M' 164.0Ω/km	.146	3.71	BC Braid 95% Shield Coverage 2.6Ω/M' 8.5Ω/km	.238	6.05	75	66%	20.5	67.3	1	.6	2.0
		CM	1000	304.8	78.0	35.4											10	1.1	3.6
		CEC:	2000	609.6	152.0	69.0											50	2.4	7.9
																			
For Plenum version of see 89555.																			
		CM															100	3.4	11.2
																	200	4.9	16.1
																	400	7.0	23.0
																	700	9.7	31.8
																	900	11.1	36.4
																	1000	12.0	39.4

75 Ohm • Dual RG-59/U Type • 23 AWG Solid .023" Bare Copper-covered Steel Conductors • Bare Copper Braid Shield (97% Coverage)

Plenum • FEP Insulation • Clear FEP Jacket

200°C	89555	NEC:	500	152.4	46.5	21.1	23 AWG (solid) .023" BCCS 50.0Ω/M' 164.0Ω/km	.134	3.40	BC Braid 97% Shield Coverage 2.6Ω/M' 8.5Ω/km	.212	5.39	75	70%	19.5	64.0	1	.5	1.6
		CMP	1000	304.8	90.0	40.9											10	1.1	3.6
		CEC:															50	2.5	8.2
																			
		CMP FT6															100	3.5	11.5
																	200	5.1	16.7
																	400	7.5	24.6
																	700	10.4	34.1
																	900	12.0	39.4
																	1000	12.7	41.7

Suitable for Outdoor and Direct Burial applications.

75 Ohm • RG-6/U Type • 18 AWG Solid Bare Copper-covered Steel Conductor • Duobond® IV Quad Shield (100% Coverage)

Non-Plenum • Gas-injected Foam Polyethylene Insulation • Gray PVC Jacket

	3131A	NEC:	1000	304.8	39.0	17.7	18 AWG (solid) .040" BCCS 28.0Ω/M' 91.9Ω/km	.180	4.57	Duobond IV* Quad Shield 3.6Ω/M' 11.8Ω/km	.300	7.62	75	82%	16.2	53.2	1	.35	1.15
		CL2R,	2500††	762.2	97.5	44.3											2	.38	1.25
		CMR															5	.45	1.48
																			
		CEC:															10	.59	1.94
		CMP FT4															20	.86	2.82
																	50	1.37	4.50
																	100	1.97	6.46
																	200	2.82	9.25
																	300	3.48	11.42
																	400	4.04	13.26

Sweep tested 5 MHz to 400 MHz.
CPE jacket optional.

For Non-plenum version see 3131A.
Sweep tested 5 MHz to 400 MHz.

Suitable for Outdoor and Direct Burial applications.

75 Ohm • RG-11/U Type • 14 AWG Solid Bare Copper-covered Steel Conductor • Duobond IV Quad Shield (100% Coverage)

Non-Plenum • Gas-injected Foam Polyethylene Insulation • Gray PVC Jacket

	3094A	NEC:	500	152.4	34.5	15.7	14 AWG (solid) .064" BCCS 11.0Ω/M' 36.1Ω/km	.280	7.11	Duobond IV* Quad Shield 1.5Ω/M' 4.9Ω/km	.407	10.34	75	82%	16.2	53.2	1	.16	.53
		CL2R,	1000	304.8	69.0	31.3											2	.18	.59
		CMR	2000	609.6	136.0	61.7											5	.26	.85
																			
		CEC:															10	.38	1.25
		CMP FT4															20	.55	1.81
																	50	.83	2.72
																	100	1.17	3.84
																	200	1.60	5.25
																	300	1.99	6.53
																	400	2.30	7.55

Tap marks every 2.6 meters to aid users in installation.

BC = Bare Copper • BCCS = Bare Copper-covered Steel • DCR = DC Resistance • FEP = Fluorinated Ethylene Propylene • SPC = Silver-coated Copper • SPCCS = Silver-coated Copper-covered Steel • TFE = Tetra Fluoroethylene

Contact the Belden Customer Service Department for a Comprehensive Connector Cross Reference. **1-800-BELDEN-1**.

* Duobond IV = Bonded Duofoil® (100% coverage) + aluminum braid (67% coverage) + Duofoil (100% coverage) + aluminum braid (46% coverage).

† May contain more than one piece, minimum length of any one piece is 25 ft.

†† Spools may contain more than one piece. Final put-up may vary ±10% for spools and reels and ±5% for UnReel® cartons. 25 feet minimum length.

Teflon is a DuPont trademark.



For more information, contact **Belden Technical Support: 1-800-BELDEN-1 • www.belden.com**

Computer and Instrumentation Cable

75 Ohm and 93 Ohm Coax

Description	Part No.	UL NEC/ C(UL) CEC Type	Standard Lengths		Standard Unit Weight		Conductor (stranding) Diameter Nom. DCR	Nominal Core OD		Shielding Materials Nom. DCR	Nominal OD		Nom. Imp. (Ω)	Nom. Vel. of Prop.	Nominal Capacitance		Nominal Attenuation		
			Ft.	m	Lbs.	kg		Inch	mm		Inch	mm			pF/Ft.	pF/m	MHz	dB/ 100 Ft.	dB/ 100m

75 Ohm • RG-11/U Type • 14 AWG Solid Bare Copper-covered Steel Conductor • Duobond IV Quad Shield (100% Coverage)

Plenum • Foam FEP Insulation • Gray Fluorocopolymer Jacket

150°C	3095A	NEC: CMP: PLTC: CEC: CMP FT6	1000	304.8	76.0	34.5	14 AWG (solid) .064" BCCS 11.0Ω/M' 36.1Ω/km	.280	7.11	Duobond IV* Quad Shield 3.9Ω/M' 12.8Ω/km	.387	9.83	75	82%	16.5	54.1	1	.20	.70	.39	1.30	1.20	3.90	1.70	5.60	2.50	8.20	3.50	11.50
-------	--------------	--	------	-------	------	------	--	------	------	---	------	------	----	-----	------	------	---	-----	-----	-----	------	------	------	------	------	------	------	------	-------

Suitable for Outdoor and Direct Burial applications.
Tap marks every 2.6 meters to aid users in installation.

93 Ohm • RG-62B/U Type • 24 AWG Stranded (7x32) .024" Bare Copper-covered Steel Conductor • BC Braid Shield (95% Coverage)

Semi-solid Polyethylene Insulation • Black Non-contaminating PVC Jacket

UL AWM Style 1354 (30V 60°C) VW-1	8255	NEC: CMX: CEC: CMX	500 1000	152.4 304.8	16.5 36.0	7.5 16.3	24 AWG (7x32) .024" BCCS 59.0Ω/M' 193.6Ω/km	.146	3.71	BC Braid 95% Shield Coverage 2.9Ω/M' 9.5Ω/km	.242	6.15	93	84%	13.5	44.3	1	.3	1.0	.9	3.0	2.0	6.6	2.9	9.5	4.2	13.8	6.1	20.0	8.6	28.2	10.1	33.1	11.1	36.4
--	-------------	-----------------------------	-------------	----------------	--------------	-------------	--	------	------	--	------	------	----	-----	------	------	---	----	-----	----	-----	-----	-----	-----	-----	-----	------	-----	------	-----	------	------	------	------	------

MIL-C-17D

93 Ohm • RG-62/U Type • JAN-C-17A • 22 AWG Solid .025" Bare Copper-covered Steel Conductor • BC Braid Shield (95% Coverage)

Semi-solid Polyethylene Insulation • Black PVC Jacket

75°C	8254	—	U-500 500	U-152.4 152.4	18.0 16.5	8.2 7.5	22 AWG (solid) .025" BCCS 41.2Ω/M' 135.1Ω/km	.146	3.71	BC Braid 95% Shield Coverage 2.9Ω/M' 9.5Ω/km	.238	6.05	93	84%	13.5	44.3	1	.3	.8	.9	2.8	1.9	6.2	2.7	8.9	3.8	12.5	5.3	17.4	7.3	23.9	8.2	26.9	8.7	28.5
------	-------------	---	--------------	------------------	--------------	------------	---	------	------	--	------	------	----	-----	------	------	---	----	----	----	-----	-----	-----	-----	-----	-----	------	-----	------	-----	------	-----	------	-----	------

93 Ohm • RG-62A/U Type • 22 AWG Solid .025" Bare Copper-covered Steel Conductor • Bare Copper Braid Shield (95% Coverage)

Semi-solid Polyethylene Insulation • Black High-density Polyethylene Jacket

Flooded Burial 80°C	9228	—	500 1000 2000 5000	152.4 304.8 609.6 1524.0	15.0 33.0 68.0 170.0	6.8 15.0 30.9 77.3	22 AWG (solid) .025" BCCS 41.2Ω/M' 135.1Ω/km	.146	3.71	BC Braid 95% Shield Coverage 2.9Ω/M' 9.5Ω/km	.242	6.15	93	84%	13.5	44.3	1	.3	.8	.9	2.8	1.9	6.2	2.7	8.9	3.8	12.5	5.3	17.4	7.3	23.9	8.2	26.9	8.7	28.5
------------------------	-------------	---	-----------------------------	-----------------------------------	-------------------------------	-----------------------------	---	------	------	--	------	------	----	-----	------	------	---	----	----	----	-----	-----	-----	-----	-----	-----	------	-----	------	-----	------	-----	------	-----	------

Suitable for Outdoor and Direct Burial applications.

Semi-solid Polyethylene Insulation • Black PVC Jacket

UL AWM Style 1478 (30V 60°C)	9268	NEC: CM CL2 CEC: CM	500 U-1000 1000 2000	152.4 U-304.8 304.8 609.6	20.0 42.0 44.0 88.0	9.1 19.1 20.0 40.0	22 AWG (solid) .025" BCCS 41.2Ω/M' 135.1Ω/km	.146	3.71	BC Braid 95% Shield Coverage 2.9Ω/M' 9.5Ω/km	.260	6.60	93	84%	13.5	44.3	1	.3	.8	.9	2.8	1.9	6.2	2.7	8.9	3.8	12.5	5.3	17.4	7.3	23.9	8.2	26.9	8.7	28.5
------------------------------------	-------------	------------------------------	-------------------------------	------------------------------------	------------------------------	-----------------------------	---	------	------	--	------	------	----	-----	------	------	---	----	----	----	-----	-----	-----	-----	-----	-----	------	-----	------	-----	------	-----	------	-----	------

IBM P/N 5252750 • Includes Mylar® tape as a moisture barrier for improved outdoor reliability.

UL AWM Style 1478 (30V 60°C)	9269	NEC: CM CL2 CEC: CM	U-500 500 U-1000 1000 1640 2000 3280 5000	U-152.4 152.4 U-304.8 304.8 500.0 609.6 1000.0 1524.0	18.5 17.0 36.0 38.0 60.7 76.0 121.4 185.0	8.4 7.7 16.7 17.2 27.5 34.5 55.0 84.0	22 AWG (solid) .025" BCCS 41.2Ω/M' 135.1Ω/km	.146	3.71	BC Braid 95% Shield Coverage 2.9Ω/M' 9.5Ω/km	.239	6.07	93	84%	13.5	44.3	1	.3	.8	.9	2.8	1.9	6.2	2.7	8.9	3.8	12.5	5.3	17.4	7.3	23.9	8.2	26.9	8.7	28.5
------------------------------------	-------------	------------------------------	--	--	--	--	---	------	------	--	------	------	----	-----	------	------	---	----	----	----	-----	-----	-----	-----	-----	-----	------	-----	------	-----	------	-----	------	-----	------

IBM P/N 323921 P-MSHA SC-1823**

*U-1000 put-up also available in Orange, Beige or Chrome.

BC = Bare Copper • BCCS = Bare Copper-covered Steel • DCR = DC Resistance • FEP = Fluorinated Ethylene Propylene

Mylar is a DuPont trademark.

Contact the Belden Customer Service Department for a Comprehensive Connector Cross Reference. **1-800-BELDEN-1**.

For cables manufactured to latest government revision or other MIL-SPEC requirements, please contact your nearest Belden regional Sales Office.

* Duobond IV = Bonded Duofoil® (100% coverage) + aluminum braid (67% coverage) + Duofoil (100% coverage) + aluminum braid (46% coverage).

** Pennsylvania Department of Environmental Resources and United States Mine Safety and Health Administration Certification.



For more information, contact **Belden Technical Support: 1-800-BELDEN-1 • www.belden.com**

Computer and Instrumentation Cable

93 Ohm Coax

Description	Part No.	UL NEC/ C(UL) CEC Type	Standard Lengths		Standard Unit Weight		Conductor (stranding) Diameter Nom. DCR	Nominal Core OD		Shielding Materials Nom. DCR	Nominal OD		Nom. Imp. (Ω)	Nom. Vel. of Prop.	Nominal Capacitance		Nominal Attenuation		
			Ft.	m	Lbs.	kg		Inch	mm		Inch	mm			pF/Ft.	pF/m	MHz	dB/100 Ft.	dB/100m

RG-62/U Type • 22 AWG Solid .025" Bare Copper-covered Steel Conductor • Bare Copper Braid Shield (94% Coverage)

Plenum • Semi-solid FEP Teflon® Insulation • Black or White Tint FEP Jacket																			
200°C	89269	NEC:	100 [▲]	30.5	5.2	2.4	22 AWG	.142	3.61	BC Braid	.200	5.08	93	85%	12.8	42.0	1	.3	1.0
		CMP	500	152.4	16.5	7.5	(solid)			94% Shield							10	.9	3.0
		CEC:	1000	304.8	33.0	15.0	.025"			Coverage							50	1.9	6.2
		CMP FT6					BCCS			3.4Ω/M'							100	2.7	8.9
							41.2Ω/M'			11.2Ω/km							200	3.8	12.5
							135.2Ω/km										400	5.3	17.4
																	700	7.3	23.9
																	900	8.2	26.9
																	1000	8.7	28.5

▲100 ft. put-up available in Black only.
Suitable for Outdoor and Direct Burial applications.

Plenum • Semi-solid FEP Teflon Insulation • Gray Fluorocopolymer Jacket																			
150°C	87269	NEC:	1000	304.8	34.0	15.4	22 AWG	.142	3.61	BC Braid	.200	5.08	93	85%	12.8	42.0	1	.3	1.0
		CMP					(solid)			94% Shield							10	.9	3.0
		CEC:					.025"			Coverage							50	1.9	6.2
		CMP FT6					BCCS			3.4Ω/M'							100	2.7	8.9
							41.2Ω/M'			11.2Ω/km							200	3.8	12.5
							135.2Ω/km										400	5.3	17.4
																	700	7.3	23.9
																	900	8.2	26.9
																	1000	8.7	28.5

Suitable for Outdoor and Direct Burial applications.

Plenum • Semi-solid FEP Teflon Insulation • Natural Flamarrest® Low-smoke Jacket																			
75°C	82269	NEC:	1000	304.8	30.0	13.6	22 AWG	.142	3.61	BC Braid	.200	5.08	93	85%	12.8	42.0	1	.3	1.0
		CMP					(solid)			94% Shield							10	.9	3.0
		CEC:					.025"			Coverage							50	1.9	6.2
		CMP FT6					BCCS			3.4Ω/M'							100	2.7	8.9
							41.2Ω/M'			11.2Ω/km							200	3.8	12.5
							135.2Ω/km										400	5.3	17.4
																	700	7.3	23.9
																	900	8.2	26.9
																	1000	8.7	28.5

Plenum • Foam FEP Teflon Insulation • White Tint FEP Jacket

200°C	86262	NEC:	500	152.4	16.0	7.3	22 AWG	.146	3.71	BC Braid	.204	5.18	93	85%	12.5	41.0	1	.3	1.8
		CMP	1000	304.8	32.0	14.5	(solid)			94% Shield							10	.9	3.0
		CEC:					.025"			Coverage							50	1.9	6.2
		CMP FT6					BCCS			3.4Ω/M'							100	2.7	8.9
							41.2Ω/M'			11.2Ω/km							200	3.8	12.5
							135.2Ω/km										400	5.3	17.4
																	700	7.3	23.9
																	900	8.2	26.9
																	1000	8.7	28.5

Suitable for Outdoor and Direct Burial applications.

Plenum • Foam FEP Teflon Insulation • Natural Flamarrest Jacket																			
75°C	82262	NEC:	U-1000	U-304.8	31.0	14.1	22 AWG	.146	3.71	BC Braid	.204	5.18	93	85%	12.5	41.0	1	.3	1.8
		CMP	1000	304.8	30.0	13.6	(solid)			94% Shield							10	.9	3.0
		CEC:					.025"			Coverage							50	1.9	6.2
		CMP FT6					BCCS			3.4Ω/M'							100	2.7	8.9
							41.2Ω/M'			11.2Ω/km							200	3.8	12.5
							135.2Ω/km										400	5.3	17.4
																	700	7.3	23.9
																	900	8.2	26.9
																	1000	8.7	28.5

BC = Bare Copper • BCCS = Bare Copper-covered Steel • DCR = DC Resistance • FEP = Fluorinated Ethylene Propylene

Contact the Belden Customer Service Department for a Comprehensive Connector Cross Reference. **1-800-BELDEN-1**.

Teflon is a DuPont trademark.



Computer and Instrumentation Cable

78 Ohm, 95 Ohm and 100 Ohm Twinax

Description	Part No.	UL NEC/ C(UL) CEC Type	Standard Lengths		Standard Unit Weight		Conductor (stranding) Diameter Nom. DCR	Nominal Core OD		Shielding Materials Nom. DCR	Nominal OD		Nom. Imp. (Ω)	Nom. Vel. of Prop.	Nominal Capacitance		Nominal Attenuation		
			Ft.	m	Lbs.	kg		Inch	mm		Inch	mm			pF/Ft.	pF/m	MHz	dB/ 100 Ft.	dB/ 100m

78 Ohm • 20 AWG Stranded (7x28) .038" Tinned Copper Conductors • Tinned Copper Braid Shield (93% Coverage)

Polyethylene Insulation • Blue PVC Jacket (Color Code: Clear, Blue)

UL AWM Style 2092 (300V 60°C)	9272	NEC: CM	100 U-500	30.5 U-152.4	4.5 20.0	2.0 9.1	20 AWG (7x28)	.156	3.96	TC Braid 93% Shield	.244	6.20	78	66%	19.7	64.6	1	.6	2.0
		CEC: CM	500 U-1000	152.4 U-304.8	18.5 39.0	8.4 17.7	.038" TC			Coverage 3.4Ω/M'							50	5.0	16.4
			1000	304.8	41.0	18.6	9.5Ω/M' 31.2Ω/km			11.2Ω/km							100	7.5	24.6
																	200	11.0	36.1
																	400	16.0	52.5

For Plenum version of 9272, see 89272.
CPE jacket optional.



Plenum • FEP Teflon® Insulation • Blue FEP Teflon Jacket (Color Code: Clear, Blue)

200°C	89272	NEC: CMP	500 1000	152.4 304.8	17.0 38.0	7.7 17.3	20 AWG (7x28)	.148	3.76	TC Braid 93% Shield	.198	5.03	78	69.5%	18.4	60.4	1	.6	2.0
		CEC: CMP FT6	500 U-1000	152.4 U-304.8	18.0 38.0	7.7 17.2	.038" TC			Coverage 3.9Ω/M'							50	5.0	16.4
			1000	304.8	39.0	17.7	9.5Ω/M' 31.2Ω/km			12.8Ω/km							100	7.5	24.6
																	200	11.0	36.1
																	400	16.0	52.5



Suitable for Aerial applications when supported by a messenger.

78 Ohm • 20 AWG Stranded (7x28) .038" Tinned Copper Conductors • Beldfoil® (100% Coverage) + TC Braid Shield (55% Coverage)

Polyethylene Insulation • Blue Sunlight-resistant PVC Jacket (Color Code: Clear, Blue)

UL AWM Style 2464 (300V 80°C)	9463	NEC: CM CL2	100 U-500	30.5 U-152.4	4.4 19.5	2.0 8.9	20 AWG (7x28)	.154	3.91	Beldfoil + 55% TC	.238	6.05	78	66%	19.7	64.6	1	.6	2.0
		CEC: CM	500 U-1000	152.4 U-304.8	18.0 38.0	8.2 17.2	.038" TC			Braid 4.1Ω/M'							50	3.6	11.8
			1000	304.8	39.0	17.7	9.5Ω/M'			13.4Ω/km							100	7.5	24.6
			6000	1828.7	234.0	106.1	31.0Ω/km										200	11.0	36.1
			10000	3048.0	380.0	172.4											400	16.0	52.5

CPE jacket optional.



PMSHA P-7K-SC-182141*
Allen Bradley P/N 1770-CD

*10000 ft. and 6000 ft. put-ups also available in Brown, Orange and Purple. 10,000 ft. available in Brown or Orange only.

RG-22B/U • 95 Ohm • 18 AWG Stranded (7x26) .046" Bare Copper Conductors • Double Tinned Copper Braid Shield (95% Coverage)**

Polyethylene Insulation • PE Inner Jacket • Black Non-contaminating PVC Outer Jacket (Color Code: Clear, Clear)

80°C VW-1	9250	—	500 1000	152.4 304.8	61.5 121.0	27.9 54.9	18 AWG (7x26)	.285	7.24	(2) TC Braids 95% Shield	.416	10.67	95	66%	16.0	52.5	1	.3	1.0
							.046" BC			Coverage .9Ω/M'							10	.9	3.0
							6.6Ω/M' 21.5Ω/km			3.0Ω/km							20	1.3	4.3
																	50	2.1	6.9
																	100	3.0	9.8
																	400	6.3	20.7

CPE jacket optional.



RG-22B/U Type

**1 conductor has tinned center strand. Non-contaminating PVC jacket.

100 Ohm • 20 AWG Stranded (7x28) .037" One Tinned/One Bare Copper Conductors • Duofoil® + Double TC Braid Shield (95% Coverage)

Polyethylene Insulation • Black High-density Polyethylene Jacket

Direct Burial 80°C	9815	—	500 1000 2000	152.4 304.8 609.6	34.5 69.0 134.0	15.7 31.4 60.9	20 AWG (7x28)	.236	5.99	TC Braid 95% Shield	.330	8.38	100	66%	14.5	47.6	1	.4	1.3
							.037" (1) TC, (1) BC			Coverage 2.0Ω/M' 6.6Ω/km							10	1.1	3.6
							9.5Ω/M' 31.0Ω/km										50	2.5	8.2
																	100	4.1	13.5
																	200	6.4	21.0
																	400	10.2	33.5

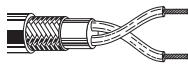

BC = Bare Copper • DCR = DC Resistance • FEP = Fluorinated Ethylene Propylene • PE = Polyethylene • TC = Tinned Copper

Contact the Belden Customer Service Department for a Comprehensive Connector Cross Reference. **1-800-BELDEN-1**.

* Pennsylvania Department of Environmental Resources and United States Mine Safety and Health Administration Certification.

† Final put-up may vary from length shown. ±10% for spools or reels, ±5% for UnReel® cartons.

Teflon is a DuPont trademark.

Computer and Instrumentation Cable

100 Ohm, 124 Ohm and 150 Ohm Twinax

Description	Part No.	UL NEC/ C(UL) CEC Type	Standard Lengths		Standard Unit Weight		Conductor (stranding) Diameter Nom. DCR	Nominal Core OD		Shielding Materials Nom. DCR	Nominal OD		Nom. Imp. (Ω)	Nom. Vel. of Prop.	Nominal Capacitance		Nominal Attenuation		
			Ft.	m	Lbs.	kg		Inch	mm		Inch	mm			pF/Ft.	pF/m	MHz	dB/100 Ft.	dB/100m

100 Ohm • 20 AWG Stranded (7x28) .037" One TC/One BC Conductor • Duofoil® (100% Coverage) + TC Braid Shield (86% Coverage)

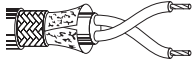
Polyethylene Insulation • Polyethylene Inner Jacket • Black PVC Outer Jacket																			
	9207 NEC: CM CL2 CEC: CMG FT4	100	30.5	7.1	3.2	20 AWG	.236	5.99	Duofoil	.330	8.38	100	66%	14.5	47.6	1	.3	1.0	
		U-500	U-152.4	33.0	15.0	(7x28)		+86%									10	1.2	3.9
		500	152.4	34.5	15.7	.037"		TC Braid									50	2.8	9.2
		1000	304.8	68.0	30.9	(1) TC,		1.7Ω/M'									100	4.1	13.5
		1640	500.0	111.5	50.7	(1) BC		5.7Ω/km									200	6.4	21.0
		2000	609.6	136.0	61.8	9.5Ω/M'											400	10.2	33.5
3280	1000.0	219.8	99.9	31.0Ω/km															
5000	1524.0	350.0	159.1																

IBM P/N 7362211

100 Ohm • 20 AWG Stranded (7x28) .037" One TC/One BC Conductor • Duofoil (100% Coverage) + TC Braid Shield (85% Coverage)

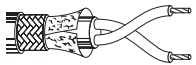
Plenum • FEP Insulation • Black FEP Jacket																			
	89207 NEC: CMP CEC: CMP FT6	100	30.5	6.7	3.0	20 AWG	.201	5.11	Duofoil	.259	6.58	100	69.5%	14.0	46.0	1	.3	1.0	
		U-500	U-152.4	26.0	11.8	(7x28)		+85%									10	1.2	3.9
		500	152.4	26.0	11.8	.037"		TC Braid									50	2.8	9.2
		1000	304.8	55.0	25.0	(1) TC, (1) BC		2.5Ω/M'									100	4.1	13.5
						9.5Ω/M'		8.2Ω/km									200	6.4	21.0
						31.2Ω/km											300	8.4	27.6
															400	10.2	33.5		

124 Ohm • 25 AWG Stranded (7x33) .021" Tinned Copper Conductors • Beldfoil® Shield (100% Coverage) • Stranded TC Drain Wire

Polyethylene Insulation • Blue PVC Jacket (Color Code: Clear, Blue)																			
	9271 UL AWM Style 2092 (300V 60°C) Shorting Fold	100	30.5	3.2	1.5	25 AWG	.170	4.32	Beldfoil	.240	6.10	124	66%	12.2	40.0	1	.6	2.0	
		U-500	U-152.4	12.5	5.7	(7x33)		12.0Ω/M'									10	1.7	5.6
		500	152.4	12.5	5.7	.021"		39.4Ω/km									50	3.6	11.8
		1000	304.8	27.0	12.3	TC											100	5.0	16.4
						31.8Ω/M'											200	6.9	22.6
						104.3Ω/km											400	9.6	31.5

124 Ohm • 16 AWG Solid .051" Bare Copper Conductors • Duofoil (100% Coverage) + Tinned Copper Braid Shield (90% Coverage)

Foam Polyethylene Insulation • Black PVC Jacket (Color Code: Clear, Blue)																			
	9860 UL AWM Style 2448 (30V 60°C) VW-1	500	152.4	52.0	23.6	16 AWG	.322	8.18	Duofoil	.440	11.18	124	78%	10.9	35.8	1	.2	.6	
		1000	304.8	103.0	46.8	(solid)		+90%									10	.7	2.3
		2000	609.6	202.0	91.8	.051"		TC Braid									50	1.8	5.9
						BC		1.3Ω/M'									100	2.9	9.5
						4.2Ω/M'		4.3Ω/km									200	4.1	13.5
						13.8Ω/km											400	6.2	20.3

150 Ohm • 22 AWG Stranded (19x34) .031" Tinned Copper Conductors • Duofoil Shield (100% Coverage) • Stranded TC Drain Wire

Datalene® Insulation • Black PVC Jacket (Color Code: Black, Yellow)																			
	9182 UL AWM Style 2668 (30V 60°C) VW-1 Shorting Fold	U-500	U-152.4	21.5	9.8	22 AWG	.275	6.98	Duofoil	.345	8.76	150	78%	8.8	28.9	1	.4	1.3	
		500	152.4	23.0	10.4	(19x34)		6.3Ω/M'									10	1.2	3.9
		1000	304.8	44.0	20.0	.031"		20.7Ω/km									50	2.7	8.7
						TC											100	4.3	14.1
						14.0Ω/M'											200	6.2	20.3
						45.9Ω/km											400	8.8	28.9

Plenum • Foam FEP Teflon Insulation • Black FEP Teflon Jacket (Color Code: Black, Yellow)																			
	89182 NEC: CMP CL2P CEC: CMP FT6	100	30.5	6.4	2.9	22 AWG	.278	7.06	Duofoil	.307	7.80	150	78%	8.8	28.9	1	.4	1.3	
		500	152.4	28.0	12.7	(19x34)		6.3Ω/M'									10	1.2	3.9
		1000	304.8	53.0	24.1	.031"		20.7Ω/km									50	2.7	8.7
						TC											100	4.3	14.1
						14.0Ω/M'											200	6.2	20.3
						45.9Ω/km											400	8.8	28.9

BC = Bare Copper • DCR = DC Resistance • FEP = Fluorinated Ethylene Propylene • TC = Tinned Copper

Contact the Belden Customer Service Department for a Comprehensive Connector Cross Reference. **1-800-BELDEN-1**.

Teflon is a DuPont trademark.



For more information, contact **Belden Technical Support: 1-800-BELDEN-1 • www.belden.com**

Computer and Instrumentation Cable

Electrical Characteristics — Twinax

Attenuation

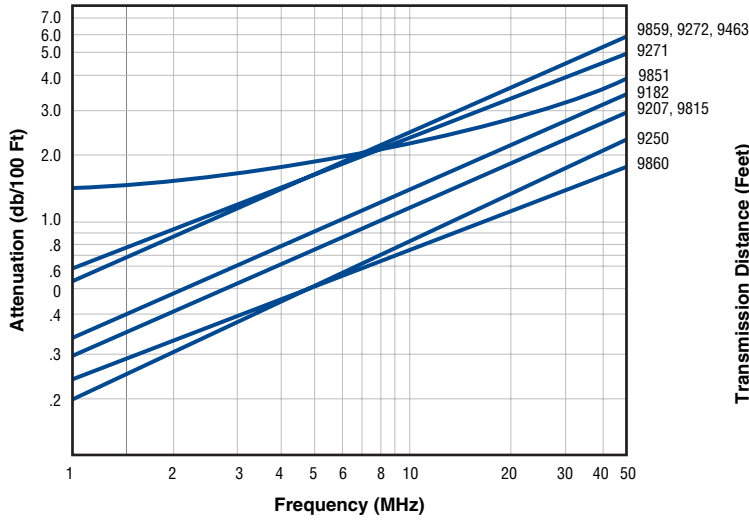

Rise Time

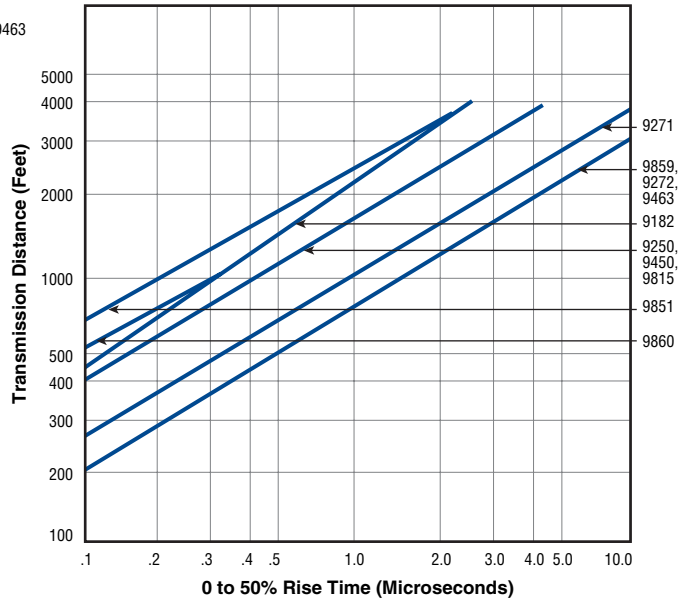

Bit Rate

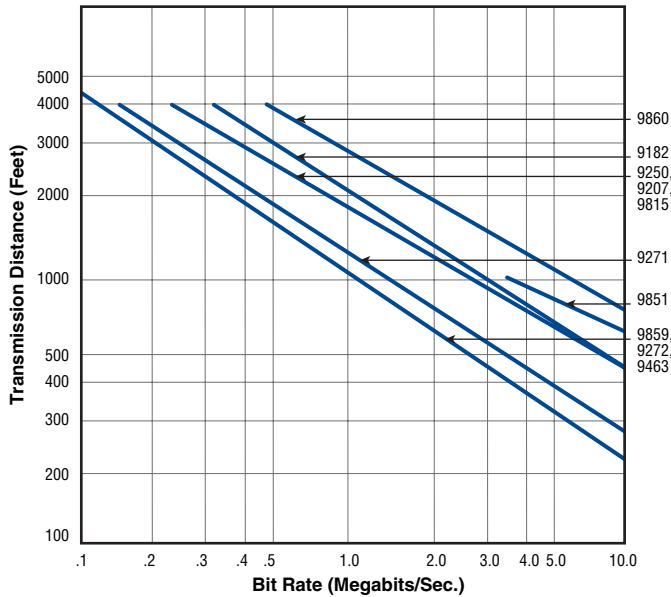

Transfer Impedance

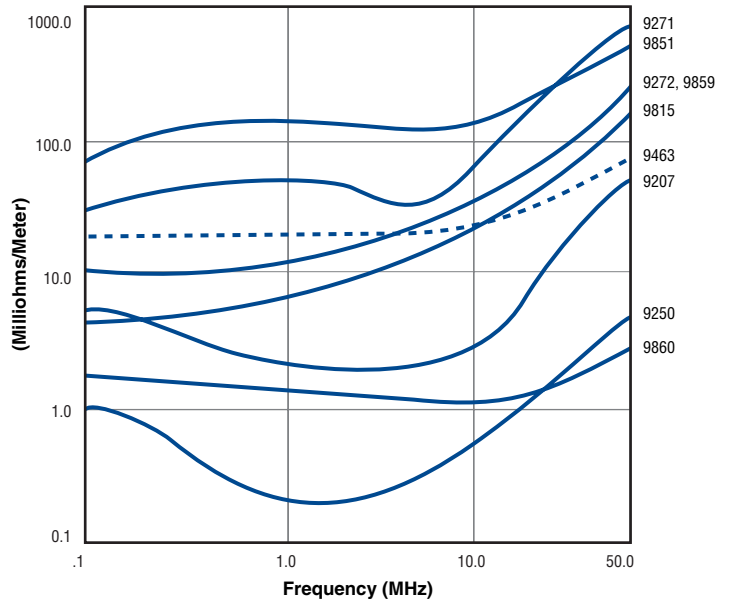

Computer and Instrumentation Cable

50 Ohm Triax

Description	Part No.	UL NEC/ C(UL) CEC Type	Standard Lengths		Standard Unit Weight		Conductor (stranding) Diameter Nom. DCR	Nominal Core OD		Shielding Materials Nom. DCR	Nominal OD		Nom. Imp. (Ω)	Nom. Vel. of Prop.	Nominal Capacitance		Nominal Attenuation		
			Ft.	m	Lbs.	kg		Inch	mm		Inch	mm			pF/Ft.	pF/m	MHz	dB/100 Ft.	dB/100m

RG-58A/U Type • 20 AWG Stranded (7x28) .037" Tinned Copper Conductor • Double Tinned Copper Braid Shield (96% Coverage)

Polyethylene Insulation • Yellow PVC Jacket (Polyethylene Insulation between Braids)																			
75°C	9222	—	100	30.5	4.6	2.1	20 AWG (7x28)	.114	2.90	(2) TC Braids 96% Shield Coverage	.240	6.10	50	66%	30.8	101.0	1	.5	1.6
			U-500	U-152.4	19.5	8.8											10	1.5	4.9
			500	152.4	20.5	9.3	.037"			TC Inner: 9.5Ω/M' 31.0Ω/km							50	3.3	10.8
										Outer: 4.7Ω/M' 15.5Ω/km							100	4.9	16.1
																	200	7.2	23.6
																	400	12.0	39.4
																	700	18.0	57.1
																	900	22.0	72.2
																	1000	24.0	78.7

RG-8/U Type • 11 AWG Stranded (7x19) .108" Bare Copper Conductor • Double Bare Copper Braid Shield (96% Coverage)

Foam Polyethylene Insulation • Black Polyethylene Jacket (Polyethylene Insulation between Braids)																			
80°C	9888	—	500	152.4	72.5	33.0	11 AWG (7x19)	.285	7.24	(2) BC 96% Shield Coverage	.480	12.19	50	78%	26.0	85.3	1	.1	.5
			1000	304.8	140.0	63.6	.108"			BC Inner: 1.2Ω/M' 3.9Ω/km							10	.5	1.7
										Outer: 2.1Ω/M' 4.9Ω/km							50	1.2	3.9
																	100	1.8	5.9
																	200	2.7	8.9
																	400	4.2	13.8
																	700	5.8	19.0
																	900	6.7	22.0
																	1000	7.1	23.3

BC = Bare Copper • DCR = DC Resistance • TC = Tinned Copper

Contact the Belden Customer Service Department for a Comprehensive Connector Cross Reference. **1-800-BELDEN-1**.

Amateur Radio and CB Coaxial Cable Assemblies

RG-8/U Type • 50 Ohm

Description	Part No.	Standard Lengths		Standard Unit Weight		Nominal OD	
		Ft.	m	Lbs.	kg	Inch	mm
RG-8/U Type • 11 AWG Stranded (7x19) BC Conductor • Military-Type Braid Coverage • Fitted with PL-259 Connectors on Both Ends							
Foam Polyethylene Insulation • Black PVC Jacket							
	9354	50	15.24	7.1	3.2	.403	10.24
	9355	75	22.86	10.7	4.9	.403	10.24
	9356	100	30.48	14.2	6.4	.403	10.24

Coax is 8214. See page 6.69 for product details.

BC = Bare Copper

These cables are designed to be used with two-way systems, such as Citizens Band (CB), Commercial, Amateur, and Marine equipment applications. They provide a positive link between the transmitter and antenna or between the receiver and antenna.

They are capable of handling higher power requirements with lower signal losses. Packaged individually.

Technical Information

Attenuation vs. Frequency for Belden® Broadband Coaxial Products

Frequency Point (MHz)	Series 59				Series 6				Series 11			
	Nominal dB/100 Ft.	Nominal dB/100m	Maximum dB/100 Ft.	Maximum dB/100m	Nominal dB/100 Ft.	Nominal dB/100m	Maximum dB/100 Ft.	Maximum dB/100m	Nominal dB/100 Ft.	Nominal dB/100m	Maximum dB/100 Ft.	Maximum dB/100m
5	.75	2.46	.89	2.92	.54	1.77	.67	2.20	.34	1.12	.38	1.25
55	1.84	6.04	1.95	6.40	1.45	4.76	1.60	5.25	.91	2.99	.97	3.18
211	3.36	11.02	3.59	11.78	2.64	8.66	2.87	9.42	1.68	5.51	1.81	5.94
216	3.41	11.19	3.69	12.11	2.67	8.76	2.95	9.68	1.70	5.58	1.84	6.04
240	3.57	11.71	3.87	12.70	2.80	9.19	3.09	10.14	1.78	5.84	1.94	6.36
270	3.79	12.43	4.05	13.29	2.97	9.74	3.24	10.63	1.89	6.20	2.05	6.73
300	3.99	13.09	4.27	14.01	3.13	10.27	3.43	11.25	1.99	6.53	2.15	7.05
325	4.16	13.65	4.50	14.76	3.26	10.70	3.59	11.78	2.07	6.79	2.24	7.35
350	4.33	14.21	4.64	15.22	3.39	11.12	3.72	12.20	2.15	7.05	2.32	7.61
375	4.49	14.73	4.84	15.88	3.52	11.55	3.87	12.70	2.22	7.28	2.40	7.87
400	4.66	15.29	4.88	16.01	3.65	11.97	4.00	13.12	2.30	7.55	2.47	8.10
450	4.96	16.27	5.30	17.39	3.88	12.73	4.26	13.98	2.45	8.04	2.65	8.69
500	5.22	17.13	5.50	18.04	4.09	13.42	4.48	14.70	2.59	8.50	2.85	9.35
550	5.48	17.98	5.90	19.36	4.30	14.11	4.71	15.45	2.73	8.96	2.94	9.65
600	5.75	18.86	6.18	20.28	4.51	14.80	4.94	16.21	2.85	9.35	3.08	10.10
650	6.03	19.78	6.52	21.39	4.72	15.49	5.18	16.99	2.98	9.78	3.22	10.56
700	6.28	20.60	6.83	22.41	4.92	16.14	5.45	17.88	3.10	10.17	3.37	11.06
750	6.51	21.36	6.96	22.83	5.11	16.76	5.59	18.34	3.21	10.53	3.50	11.48
800	6.71	22.01	7.30	23.95	5.27	17.29	5.75	18.86	3.32	10.89	3.65	11.97
862	6.97	22.87	7.50	24.61	5.47	17.95	5.98	19.62	3.46	11.35	3.82	12.53
870	7.00	22.97	7.54	24.74	5.49	18.01	6.00	19.68	3.48	11.42	3.84	12.60
900	7.14	23.42	7.79	25.56	5.60	18.37	6.11	20.05	3.55	11.65	3.96	12.99
950	7.39	24.25	7.90	25.92	5.79	19.00	6.35	20.83	3.66	12.01	4.10	13.45
1000	7.68	25.20	8.09	26.54	5.99	19.65	6.54	21.46	3.77	12.37	4.23	13.88
1450	—	—	—	—	7.80	25.60	8.00	26.20	5.00	16.41	5.50	18.10
1800	—	—	—	—	8.60	28.20	8.80	28.90	5.70	18.70	6.27	20.60
2250	—	—	—	—	9.80	32.20	10.00	32.80	6.50	21.33	7.15	23.50
3000	—	—	—	—	11.30	37.10	11.90	39.00	8.00	26.25	8.80	28.90



Flat Cable

Table of Contents

Flat Cable	Page No.
Introduction	7.2
Gray Ribbon	7.3–7.6
9L300XX Series: .025" Pitch, 30 AWG, PVC	7.3
2L280XX Series: 1mm Pitch, 28 AWG, PVC	7.4
9L280XX Series: .050" Pitch, 28 AWG, PVC	7.5
9L260XX Series: .050" Pitch, 26 AWG, PVC	7.6
Rainbow	7.7–7.8
9R280XX Series: .050" Pitch, 28 AWG, Color-coded PVC	7.7
8R280XX Series: .050" Pitch, 28 AWG, Color-coded FEP	7.8
Vari-Twist®	7.9–7.10
9V280XX Series: .050" Pitch, 28 AWG, PVC	7.9
8V280XX Series: .050" Pitch, 28 AWG, FEP	7.10
Shielded Jacketed	7.11
9L283XX Series: .050" Pitch, 28 AWG, PVC	7.11
Shielded Jacketed Vari-Twist	7.12
9V283XX Series: .050" Pitch, 28 AWG, PVC	7.12
Technical Information	7.13–7.14

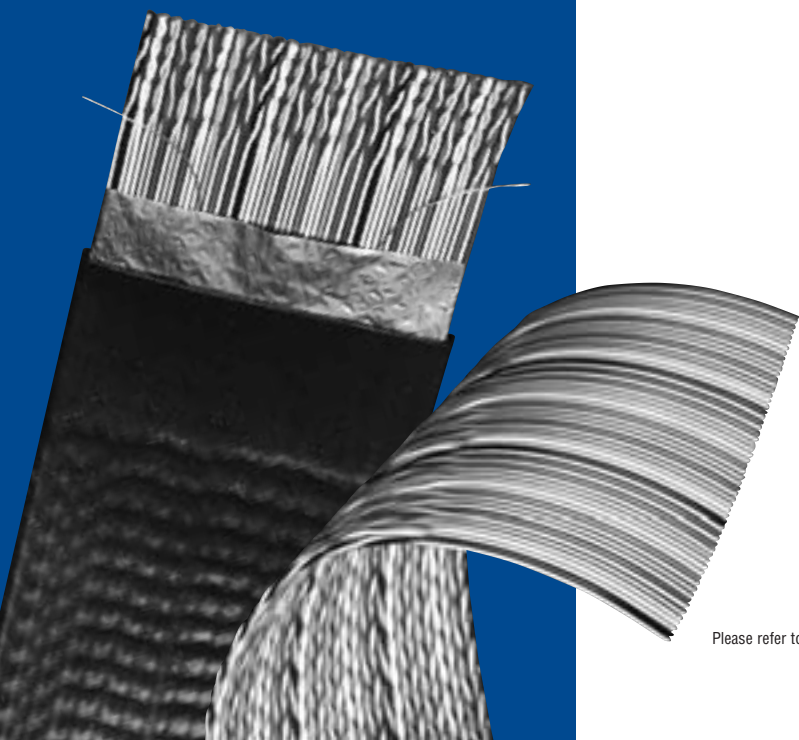

Introduction

Belden® flat cables are designed using the same expertise and design sophistication that made Belden a leader in round cable. Whatever your application, Belden is committed to offering quality flat cable products at a competitive price. Our extensive line includes Gray Ribbon, Rainbow, Vari-Twist® and Shielded and Jacketed Flat Cable options. Many of these are available off the shelf from local distributors. If you have a new or unusual application or you cannot find a flat cable in this catalog section that meets your technical requirements, contact Technical Support at 1-800-BELDEN-1.

Benefits of Flat Cable

- **Mass Termination** Terminating flat cable is done with the entire group of conductors as a unit, which is more efficient than working with individual conductors at one time.
- **Reliability** The simplicity of flat cable with its parallel conductor geometry eliminates many of the common sources of wiring error and malfunction. Registration of the conductors is one-to-one with the terminating connector or board so that proper contact assignment is almost automatic.
- **Space and Weight Reduction** The use of flat cable often eliminates much of the conventional wire weight and bulk. Such things as redundant insulating materials, fillers and tapes are not required. In addition, the composite flat cable construction is so mechanically strong that it is not necessary to have large conductors for strength. The copper cross-section can thus be reduced to what's required to carry the current load or to satisfy voltage drop requirements.
- **Flexibility** Flat cable is extremely flexible when bent in the plane of its thin cross-section. This flexibility has been utilized in applications where continuous or high flexing is necessary, e.g. drawers, doors, rotating arms, etc.
- **Greater Strength** Strength is enhanced by the fact that all conductors and insulation equally share tensile loads.
- **Consistent Electrical Characteristics** Because the conductor spacing is fixed and the geometry of the cable is constant, the electrical characteristics, such as impedance, capacitance, inductance, time delay, crosstalk and attenuation, are consistent.
- **Greater Current Carrying Capacity** Flat cables have greater surface-to-volume ratio than their round cable counterparts, consequently having higher efficiency in dissipating heat. This allows a higher current level for a given temperature rise and conductor cross-section.

- **Reduced Skewing Effects** Due to the conductors having the exact physical and electrical length, along with a continuous and consistent dielectric, time delays between signals within a given flat cable are minimized.
- **High-Density Interconnections** The cabling density achievable using flat cable is superior to that using conventional cable because of the high wire-to-cable cross-sectional density. Layers of flat cable are more effectively packed for higher conductor density than round cable.
- **Ease of Handling** Flat cable folds and bends readily, conforms to the mounting area, fastens easily with clamps, adhesive, or double-faced tape, and eliminates the installation and lacing difficulties associated with round wire cabling. Visible conductors in a fixed position within the dielectric simplify coding, inspection and circuit tracing.

Flat Cable Packaging

Packaging of flat cable is offered in one or more of the following configurations, as noted in the Physical Specifications table for each product:

- 100:** 100' put-up in a cardboard container. May contain more than one piece.
- H100:** A one-piece 100' length, in a cardboard container.
- H300:** 300' length in a cardboard container may contain more than one piece.
- R300:** 300' length put-up on a reel may contain more than one piece. It is designed for use by assemblers who use automated terminating equipment. An additional feature is the 9" inner tail exposed through the flange. This enables users to terminate the cable end to a device, which is necessary for in-line testing.

Note: Material on this page obtained from and printed with the permission of the Institute for Interconnecting and Packaging Electronic Circuits (IPC).

Gray Ribbon 9L300XX Series

.025" Pitch, 30 AWG, PVC

Product Description

Belden's miniaturized .025" pitch extruded gray ribbon cable provides higher signal density, greater design flexibility, and an alternative to the expensive Teflon® transmission cables. The cable is manufactured to precise tolerances which allows for mass-termination to standard .050" contact IDC connectors while assuring consistent and reliable electrical characteristics. With the miniaturization of the interconnects, significant reduction in components can be achieved. The cable is constructed of stranded 30 AWG (7x38) tinned copper conductors. Insulation material consists of Gray PVC, with a Red polarity stripe for proper circuit alignment. Standard conductor counts are 26 and 50; other sizes are available upon request. The cable is UL approved and CSA certified, and passes the VW-1 Vertical Wire Flame Test.

Color Code: Gray with Red polarity stripe.

Application: Internal interconnection or internal wiring of electronic equipment.

Physical Specifications

Conductor	30 AWG (7x38) Tinned Copper
Insulation	.0075" Nom. Wall Gray PVC
Pitch	.025" ± .002"
Temperature Rating	-40 to +105°C
Flammability Rating	UL: VW-1, CSA: FT1
UL Approval	File #E12683, Style 2678
CSA Approval	File #LL7874, CSA AWM I A 105°C 150V FT1
Packaging	H100, H300

Electrical Specifications

Voltage Rating	150V RMS
Current Rating	.5A
Conductor Resistance	108Ω/1000 ft.
Insulation Resistance	>1 x 10 ¹⁰ Ω • 10 ft. (3m)
Impedance*	70Ω
Capacitance* (@ 1 MHz)	24 pF/ft. (79 pF/m)
Inductance* (@ 1 MHz)	.14 μH/ft. (.46 μH/m)
Propagation Delay*	1.52 ns/ft. (4.99 ns/m)

*Test Configuration: G-S-G (ground-signal-ground).

Unbalanced Crosstalk

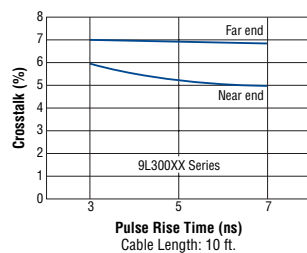

Attenuation

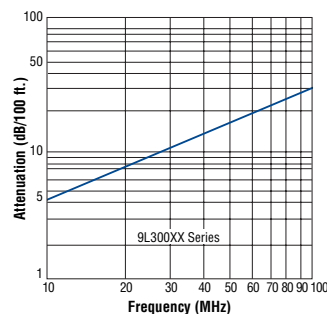

Teflon is a DuPont trademark.

Part No.	No. of Cond.	Dimensions			
		Width "A"		Span "B"	
		Inch	mm	Inch	mm
9L30026	26	.650 ±.010	16.51 ±.25	.625 ±.007	15.88 ±.18
9L30050[†]	50	1.250 ±.011	31.75 ±.28	1.225 ±.009	31.12 ±.23

[†]Available in H100 packaging only.

Dimensions

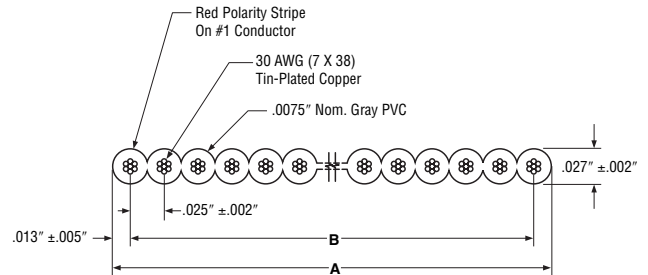

Gray Ribbon 2L280XX Series

1mm Pitch, 28 AWG, PVC

Product Description

Belden's 1mm (.03937" pitch) extruded gray ribbon cable was designed for the disk drive market where the 2mm IDC connector is widely used. The cable provides improved space reduction, easy breakouts for circuit routing, and maintains the current carrying capacity required for these applications. In addition, the electrical performance meets those requirements specified by the SCSI-3 parallel interface document. The cable is constructed of stranded 28 AWG (7x36) tinned copper conductors. Insulation material consists of Gray PVC, with a Black polarity stripe for proper circuit alignment. Standard conductor counts are 26, 34, 40, 44 and 50; other sizes are available upon request. The cable is UL approved and CSA certified, and passes the VW-1 Vertical Wire Flame Test.

Color Code: Gray with Black polarity stripe.

Application: Internal interconnection or internal wiring of electronic equipment.

Physical Specifications

Conductor	28 AWG (7x36) Tinned Copper
Insulation	.010" Nom. Wall Gray PVC
Pitch	1mm ± 0.51mm (.0394" ± .002")
Temperature Rating	-40 to +105°C
Flammability Rating	UL: VW-1; CSA: FT1
UL Approval	File #E12683, Style 2651
CSA Approval	File #LL7874, CSA AWM I A 105°C 300V FT1
Packaging	H100, R300

Electrical Specifications

Voltage Rating	300V RMS
Current Rating	1A
Conductor Resistance	68.2Ω/1000 ft.
Insulation Resistance	>1 x 10 ¹⁰ Ω • 10 ft. (3m)
Impedance*	90Ω
Capacitance* (@ 1 MHz)	16.5 pF/ft. (54 pF/m)
Inductance* (@ 1 MHz)	.16 μH/ft. (.52 μH/m)
Propagation Delay*	1.47 ns/ft. (4.8 ns/m)

*Test Configuration: G-S-G (ground-signal-ground).

Part No.	No. of Cond.	Dimensions			
		Width "A"		Span "B"	
		Inch	mm	Inch	mm
2L28026**	26	1.020 ±.008	25.9 ±.20	.984 ±.008	25.0 ±.20
2L28034**	34	1.335 ±.012	33.9 ±.30	1.299 ±.012	33.0 ±.30
2L28040**	40	1.571 ±.012	39.9 ±.30	1.535 ±.012	39.0 ±.30
2L28044**	44	1.728 ±.012	43.9 ±.30	1.693 ±.012	43.0 ±.30
2L28050	50	1.965 ±.012	49.9 ±.30	1.929 ±.012	49.0 ±.30

**Available in H100 packaging only.

Dimensions

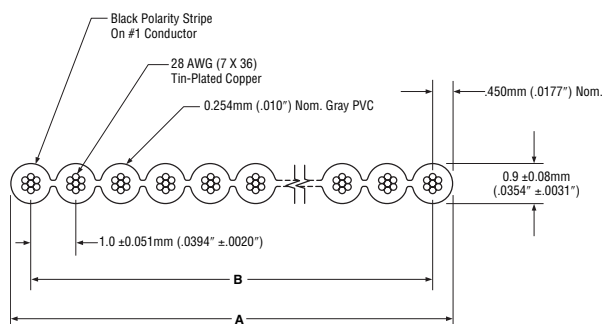

Unbalanced Crosstalk*

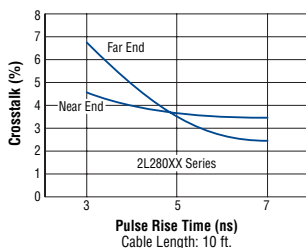

Attenuation*

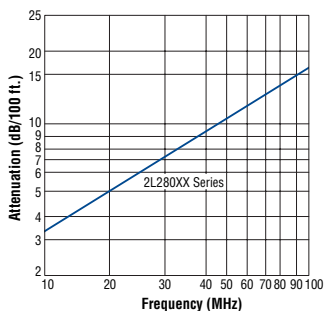

Gray Ribbon 9L280XX Series

.050" Pitch, 28 AWG, PVC

Product Description

Belden's (9L280XX Series) .050" pitch extruded gray ribbon cable was designed for general purpose electronic interconnect applications. The cable provides reliable mass-termination to standard .100" contact IDC connectors, flexibility, consistent electricals and break-outs can be made easily with the tear feature design. The cable is constructed of stranded 28 AWG (7x36) tinned copper conductors. Insulation material consists of Gray PVC, with a Red polarity stripe for proper circuit alignment. Various conductor counts are standard; other sizes are available upon request. The cable is UL approved and CSA certified, and passes the VW-1 Vertical Wire Flame Test.

Color Code: Gray with Red polarity stripe (standard).

Application: Internal interconnection or internal wiring of electronic equipment.

Physical Specifications

Conductor	28 AWG (7x36) Tinned Copper
Insulation	.010" Nom. Wall Gray PVC
Pitch	.050" ± .002"
Temperature Rating	-40 to +105°C
Flammability Rating	UL: VW-1; CSA: FT1
UL Approval	File #E12683, Style 2651
CSA Approval	File #LL7874, CSA AWM I A 105°C 300V FT1
Packaging	H100, H300, R300

Electrical Specifications

Voltage Rating	300V RMS
Current Rating	1A
Conductor Resistance	68.2Ω/1000 ft.
Insulation Resistance	>1 x 10 ¹⁰ Ω • 10 ft. (3m)
Impedance*	105Ω
Capacitance* (@ 1 MHz)	15 pF/ft. (49 pF/m)
Inductance* (@ 1 MHz)	.20 μH/ft. (.66 μH/m)
Propagation Delay*	1.40 ns/ft. (4.6 ns/m)

*Test Configuration: G-S-G (ground-signal-ground).

Unbalanced Crosstalk*

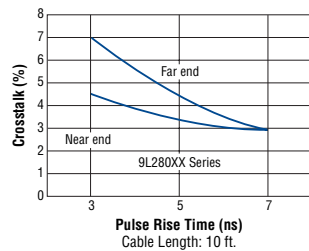

Attenuation*

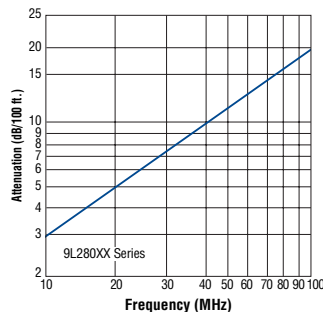

Part No. Standard [UL & CSA]	No. of Cond.	Dimensions			
		Width "A"		Span "B"	
		Inch	mm	Inch	mm
9L28009	9	.45 ±.008	11.43 ±.20	.40 ±.008	10.16 ±.20
9L28010	10	.50 ±.008	12.70 ±.20	.45 ±.008	11.43 ±.20
9L28014 [†]	14	.70 ±.008	17.78 ±.20	.65 ±.008	16.51 ±.20
9L28015**	15	.75 ±.008	19.05 ±.20	.70 ±.008	17.78 ±.20
9L28016	16	.80 ±.008	20.32 ±.20	.75 ±.008	19.05 ±.20
9L28020	20	1.00 ±.008	25.40 ±.20	.95 ±.008	24.13 ±.20
9L28024 [†]	24	1.20 ±.008	30.48 ±.20	1.15 ±.008	29.21 ±.20
9L28025	25	1.25 ±.008	31.75 ±.20	1.20 ±.008	30.48 ±.20
9L28026	26	1.30 ±.008	33.02 ±.20	1.25 ±.008	31.75 ±.20
9L28034	34	1.70 ±.008	43.18 ±.20	1.65 ±.008	41.91 ±.20
9L28036**	36	1.80 ±.012	45.72 ±.30	1.75 ±.012	44.45 ±.30
9L28037**	37	1.85 ±.012	46.99 ±.30	1.80 ±.012	45.72 ±.30
9L28040	40	2.00 ±.012	50.80 ±.30	1.95 ±.012	49.53 ±.30
9L28050	50	2.50 ±.012	63.50 ±.30	2.45 ±.012	62.23 ±.30
9L28060	60	3.00 ±.012	76.20 ±.30	2.95 ±.012	74.93 ±.30
9L28064	64	3.20 ±.012	81.28 ±.30	3.15 ±.012	80.01 ±.30

** Available in H100 packaging only.
[†] Not available in R300 packaging.

Dimensions

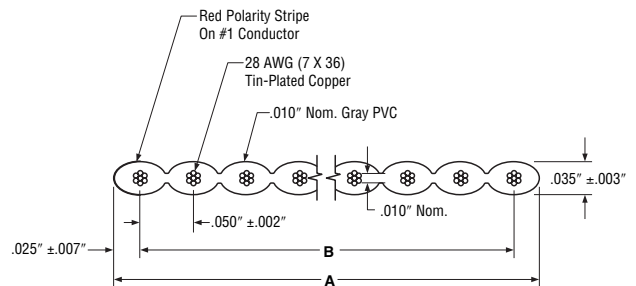

Gray Ribbon 9L260XX Series

.050" Pitch, 26 AWG, PVC

Product Description

Belden's (9L260XX series) .050" pitch extruded gray ribbon cable was designed for general purpose electronic interconnect applications where higher current carrying capacities are required. The design also conforms to the electrical performance specifications outlined by the SCSI-3 parallel interface document. As with the 9L280XX series, the cable provides reliable mass-termination to standard .100" contact IDC connectors, flexibility, consistent electricals and breakouts can be made easily with the tear feature design. In addition, the overall cable thickness is only .038" ± .002" allowing mateability with all standard IDC connectors. The cable is constructed of stranded 26 AWG (7x34) tinned copper conductors. Insulation material consists of Gray PVC, with a Blue polarity stripe for proper circuit alignment. Various conductor counts are standard; other sizes are available upon request. The cable is UL approved and CSA certified, and passes the VW-1 Vertical Wire Flame Test.

Color Code: Gray with Blue polarity stripe (standard).

Application: Internal interconnection or internal wiring of electronic equipment.

Physical Specifications

Conductor	26 AWG (7x34) Tinned Copper
Insulation	.010" Nom. Wall Gray PVC
Pitch	.050" ± .002"
Temperature Rating	-40 to +105°C
Flammability Rating	UL: VW-1; CSA: FT1
UL Approval	File #E12683, Style 2651
CSA Approval	File #LL7874, CSA AWM I A 105°C 300V FT1
Packaging	H100, H300, R300

Electrical Specifications

Voltage Rating	300V RMS
Current Rating	1.5A
Conductor Resistance	43Ω/1000 ft.
Insulation Resistance	>1 x 10 ¹⁰ Ω • 10 ft. (3m)
Impedance*	90Ω
Capacitance* (@ 1 MHz)	18 pF/ft. (59.06 pF/m)
Inductance* (@ 1 MHz)	.15 μH/ft. (.49 μH/m)
Propagation Delay*	1.48 ns/ft. (4.85 ns/m)

*Test Configuration: G-S-G (ground-signal-ground).

Part No. Standard [UL & CSA]	No. of Cond.	Dimensions			
		Width "A"		Span "B"	
		Inch	mm	Inch	mm
9L26010	10	.50 ±.008	12.70 ±.20	.45 ±.008	11.43 ±.20
9L26014 ^{††}	14	.70 ±.008	17.78 ±.20	.65 ±.008	16.51 ±.20
9L26016 ^{**}	16	.80 ±.008	20.32 ±.20	.75 ±.008	19.05 ±.20
9L26020 ^{††}	20	1.0 ±.008	25.40 ±.20	.95 ±.008	24.13 ±.20
9L26025 ^{**}	25	1.25 ±.008	31.75 ±.20	1.20 ±.008	30.48 ±.20
9L26026 ^{††}	26	1.30 ±.008	33.02 ±.20	1.25 ±.008	31.75 ±.20
9L26034 ^{**}	34	1.70 ±.008	43.18 ±.20	1.65 ±.008	41.91 ±.20
9L26040 [†]	40	2.00 ±.012	50.80 ±.30	1.95 ±.012	49.53 ±.30
9L26068 ^{**}	68	3.40 ±.012	86.36 ±.30	3.35 ±.012	85.09 ±.30

** Available in H100 packaging only.
[†] Not available in H300 packaging.
^{††} Not available in R300 packaging.

Dimensions

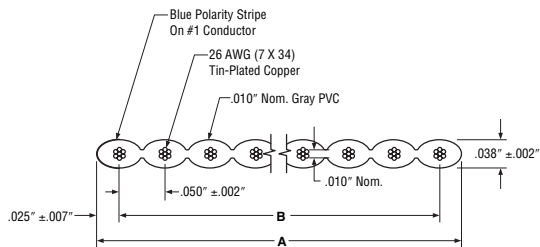

Unbalanced Crosstalk*

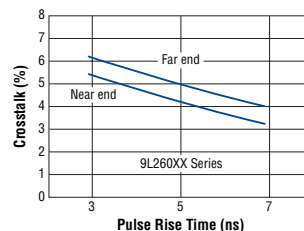

Attenuation*

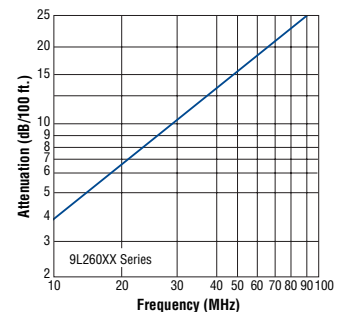

Rainbow 9R280XX Series

.050" Pitch, 28 AWG, Color-coded PVC

Product Description

Belden's .050" pitch, color-coded PVC flat cable allows for quick identification and circuit tracing, along with easy breakouts for circuit routing. Designed for mass-termination with standard IDC connectors, the cable is constructed of stranded 28 AWG (7x36) tinned copper conductors, color-coded PVC pre-insulated singles — laminated to a single clear PVC substrate. Fourteen various conductor counts are standard; other sizes are available upon request. The cable is UL approved (CSA available upon request) and passes the VW-1 Vertical Wire Flame Test.

Color Code: Brown, Red, Orange, Yellow, Green, Blue, Purple, Gray, White, Black. Sequence is repeated as necessary.

Application: Internal interconnection or internal wiring of electrical equipment.

Physical Specifications

Conductor	28 AWG (7x36) Tinned Copper
Insulation	.010" Nom. Wall Color-coded PVC
Substrate	.010" Nom. Wall Clear PVC
Pitch	.050" ± .005"
Temperature Rating	-20 to +105°C
Flammability Rating	UL: VW-1
UL Approval	File #E12663, Style 2884
CSA Approval	Available upon request
Packaging	100

Electrical Specifications

Voltage Rating	300V RMS
Current Rating	1A
Conductor Resistance	68.2Ω/1000 ft.
Insulation Resistance	>1 x 10 ¹⁰ Ω • 10 ft. (3m)
Impedance*	105Ω
Capacitance* (@ 1 MHz)	15 pF/ft. (49 pF/m)
Inductance* (@ 1 MHz)	.20 μH/ft. (.66 μH/m)
Propagation Delay*	1.40 ns/ft. (4.6 ns/m)

*Test Configuration: G-S-G (ground-signal-ground).

Unbalanced Crosstalk*

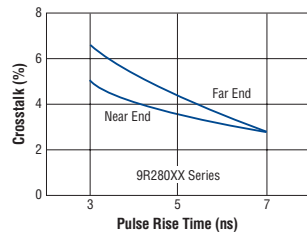

Attenuation*

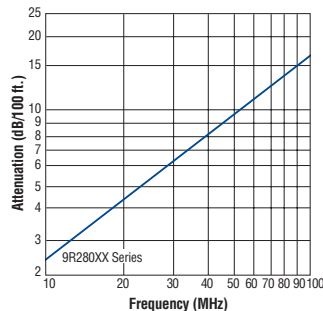

Part No.	No. of Cond.	Dimensions			
		Width "A"		Span "B"	
		Inch	mm	Inch	mm
9R28010	10	.50	12.70	.45 ±.007	11.43 ±.18
9R28014	14	.70	17.78	.65 ±.007	16.51 ±.18
9R28016	16	.80	20.32	.75 ±.011	19.05 ±.28
9R28020	20	1.00	25.40	.95 ±.011	24.13 ±.28
9R28024	24	1.20	30.48	1.15 ±.011	29.21 ±.28
9R28025	25	1.25	31.75	1.20 ±.011	30.48 ±.28
9R28026	26	1.30	33.02	1.25 ±.011	31.75 ±.28
9R28034	34	1.70	43.18	1.65 ±.011	41.91 ±.28
9R28037	37	1.85	46.99	1.80 ±.015	45.72 ±.38
9R28040	40	2.00	50.80	1.95 ±.015	49.53 ±.38
9R28050	50	2.50	63.50	2.45 ±.015	62.23 ±.38
9R28060	60	3.00	76.20	2.95 ±.015	74.93 ±.38
9R28064	64	3.20	81.28	3.15 ±.020	80.01 ±.51

Dimensions

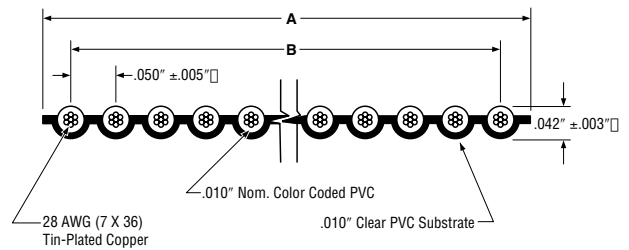

Rainbow 8R280XX Series

.050" Pitch, 28 AWG, Color-coded FEP (High Temperature)

Product Description

Belden's .050" pitch, color-coded FEP flat cable allows for high and low temperature, low out-gassing and chemical resistant applications, improved electricals, and provides quick identification and circuit tracing, along with easy breakouts for circuit routing. Designed for mass-termination with standard IDC connectors, the cable is constructed of stranded 28 AWG (7x36) silver-plated copper conductors, color-coded FEP pre-insulated singles — laminated to a single clear FEP substrate. Thirteen various conductor counts are standard; other sizes are available upon request. The cable is UL approved and passes the IEEE 383-1974, 70,000 BTU Flame Test.

Color Code: Brown, Red, Orange, Yellow, Green, Blue, Purple, Gray, White, Black. Sequence is repeated as necessary.

Application: Internal wiring of appliances or electronic equipment. May be additionally marked "For 300V Peak Electronic Use Only."

Physical Specifications

Conductor	28 AWG (7x36) Silver-plated Copper
Insulation	.010" Nom. Wall Color-coded FEP
Substrate	.010" Nom. Wall Clear FEP
Pitch	.050" ± .005"
Temperature Rating	-70 to +150°C
Flammability Rating	UL: VW-1; IEEE: 383-1974 70,000 BTU
UL Approval	File #E12683, Style 20468
Packaging	100

Electrical Specifications

Voltage Rating	150V RMS
Current Rating	1A
Conductor Resistance	68.2Ω/1000 ft.
Insulation Resistance	>1 x 10 ¹¹ Ω • 10 ft. (3m)
Impedance*	120Ω
Capacitance* (@ 1 MHz)	10.5 pF/ft. (34.5 pF/m)
Inductance* (@ 1 MHz)	.18 μH/ft. (.59 μH/m)
Propagation Delay*	1.30 ns/ft. (4.3 ns/m)

*Test Configuration: G-S-G (ground-signal-ground).

Part No.	No. of Cond.	Dimensions			
		Width "A"		Span "B"	
		Inch	mm	Inch	mm
8R28010	10	.50	12.70	.45 ±.007	11.43 ±.18
8R28014	14	.70	17.78	.65 ±.007	16.51 ±.18
8R28016	16	.80	20.32	.75 ±.011	19.05 ±.28
8R28020	20	1.00	25.40	.95 ±.011	24.13 ±.28
8R28025	25	1.25	31.75	1.20 ±.011	30.48 ±.28
8R28026	26	1.30	33.02	1.25 ±.011	31.75 ±.28
8R28034	34	1.70	43.18	1.65 ±.011	41.91 ±.28
8R28037	37	1.85	46.99	1.80 ±.015	45.72 ±.38
8R28040	40	2.00	50.80	1.95 ±.015	49.53 ±.38
8R28050	50	2.50	63.50	2.45 ±.015	62.23 ±.38
8R28060	60	3.00	76.20	2.95 ±.015	74.93 ±.38
8R28064	64	3.20	81.28	3.15 ±.020	80.01 ±.51

Dimensions

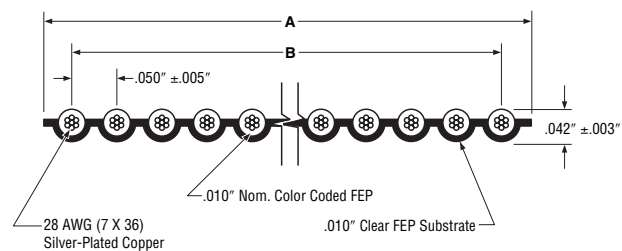

Unbalanced Crosstalk*

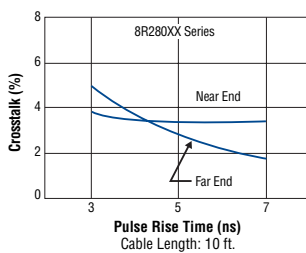

Attenuation*

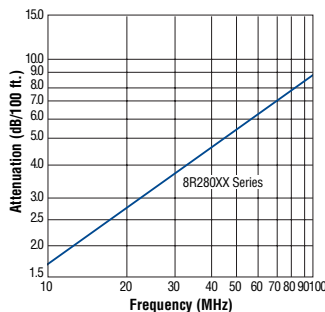

Vari-Twist® 9V280XX Series

.050" Pitch, 28 AWG, PVC

Product Description

Belden's PVC Vari-Twist 9V280XX series was designed to reduce crosstalk in the balanced mode by twisting the pairs, but can be mass-terminated in the programmed flat sections with any standard IDC connector. To further reduce crosstalk, each adjacent pair is twisted in the opposite direction. The standard twist length is 18 inches followed by a 2 inch flat section of .050" spaced conductors. The cable consists of stranded 28 AWG (7x36) tinned copper, color-coded PVC pre-insulated singles — laminated to a single clear PVC substrate. Eleven various conductor/pair counts are standard; other sizes are available upon request. The cable is UL approved (CSA available upon request) and passes the VW-1 Vertical Wire Flame Test.

Upon your request, Vari-Twist can also be manufactured to your own specific requirements whether that be longer or shorter twist sections and/or flat sections.

Color Code: Each pair consists of a Tan conductor paired with a color-coded conductor. *Color Sequence Each Terminating Section:* Brown/Tan, Red/Tan, Orange/Tan, Yellow/Tan, Green/Tan, Blue/Tan, Purple/Tan, Gray/Tan, White/Tan, Black/Tan. Sequence is repeated as necessary.

Application: Internal interconnection or internal wiring of electronic equipment.

Physical Specifications

Conductor	28 AWG (7x36) Tinned Copper
Insulation	.010" Nom. Wall Color-coded PVC
Substrate	.010" Nom. Wall Clear PVC
Pitch	
Twisted Pair Centers:	.100" Nom.
Conductor Centers in Flat:	.050" ± .005"
Pairs	1/2" Nom. Lay
	Adjacent Pairs have Opposite Direction Lay
Construction	18" of Twisted Pairs 2" of Flat Section
Temperature Rating	-20 to +105°C
Flammability Rating	UL: VW-1
UL Approval	File #E12683, Style Dual Rated 2693 & 2697
CSA Approval	Available Upon Request
Packaging	H100

Electrical Specifications

Voltage Rating	300V RMS
Current Rating	1A
Conductor Resistance	68.2Ω/1000 ft.
Insulation Resistance	>1 x 10 ¹⁰ Ω • 10 ft. (3m)
Impedance (Balanced)	115Ω
Impedance* (Unbalanced)	100Ω
Capacitance* (@ 1 MHz)	16 pF/ft. (52 pF/m)
Inductance* (@ 1 MHz)	.24 μH/ft. (.79 μH/m)
Propagation Delay*	1.60 ns/ft. (5.25 ns/m)

*Test Configuration: G-S (ground-signal), unbalanced.

Part No.	No. of Pairs	Dimensions			
		Width "A"		Span "B"	
		Inch	mm	Inch	mm
9V28010	5	.50	12.70	.45 ±.012	11.43 ±.31
9V28014	7	.70	17.78	.65 ±.012	16.51 ±.30
9V28016	8	.80	20.32	.75 ±.012	19.05 ±.30
9V28020	10	1.00	25.40	.95 ±.015	24.13 ±.38
9V28026	13	1.30	33.02	1.25 ±.015	31.75 ±.38
9V28034	17	1.70	43.18	1.65 ±.015	41.91 ±.38
9V28036	18	1.80	45.72	1.75 ±.017	44.45 ±.43
9V28040	20	2.00	50.80	1.95 ±.017	49.53 ±.43
9V28050	25	2.50	63.50	2.45 ±.017	62.23 ±.43
9V28060	30	3.00	76.20	2.95 ±.020	74.93 ±.51
9V28064	32	3.20	81.28	3.15 ±.020	80.01 ±.51

Dimensions

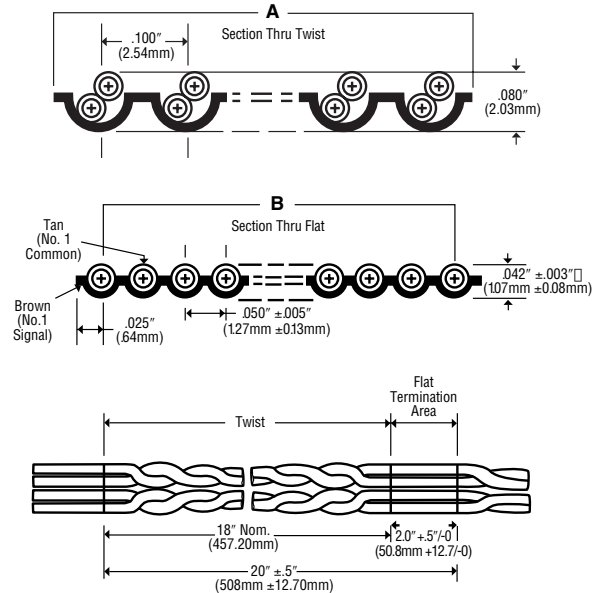

NOTE: the transition area is included in the twisted section to assure a full 2 inches of flat termination area.

Unbalanced Crosstalk*

(See page 7.14 for Balanced Crosstalk)

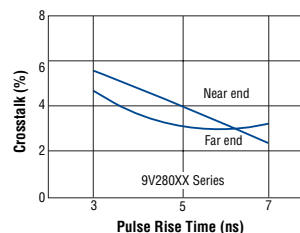

Attenuation*

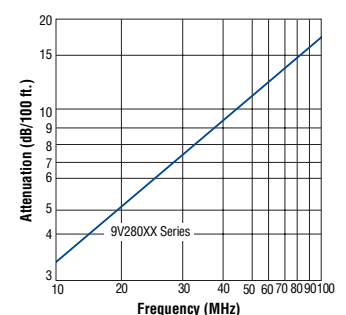

Vari-Twist® 8V280XX Series

.050" Pitch, 28 AWG, FEP (High Temperature)

Product Description

Belden's FEP Vari-Twist 8V280XX series allows for high and low temperature, low out-gassing, and chemical resistant applications, improved electricals, and provides quick identification and circuit tracing. The cable was designed to reduce crosstalk in the balanced mode by twisting the pairs but can be mass-terminated in the programmed flat sections with any standard IDC connector. To further reduce crosstalk, each adjacent pair is twisted in the opposite direction. The standard twist length is 18 inches followed by a 2 inch flat section of .050" spaced conductors. The cable consists of stranded 28 AWG (7x36) silver-plated copper, color-coded FEP pre-insulated singles — laminated to a single clear FEP substrate. Eight various conductor/pair counts are standard; other sizes are available upon request. The cable is UL approved and passes the IEEE 383-1974 70,000 BTU Flame Test.

Upon your request, Vari-Twist can also be manufactured to your own specific requirements whether that be longer or shorter twist sections and/or flat sections.

Color Code: Each pair consists of a Tan conductor paired with a color-coded conductor. *Color Sequence Each Terminating Section:* Brown/Tan, Red/Tan, Orange/Tan, Yellow/Tan, Green/Tan, Blue/Tan, Purple/Tan, Gray/Tan, White/Tan, Black/Tan. Sequence is repeated as necessary.

Application: Internal wiring of appliances or electronic equipment. May be additionally marked "For 300V Peak Electronic Use Only."

Physical Specifications

Conductor	28 AWG (7x36) Silver-plated Copper
Insulation	.010" Nom. Wall Color-coded FEP
Substrate	.010" Nom. Wall Clear FEP
Pitch	
Twisted Pair Centers:	.100" Nom.
Conductor Centers in Flat:	.050" ± .005"
Pairs	1/2" Nom. Lay
	Adjacent Pairs have Opposite Direction Lay
Construction	18" of Twisted Pairs 2" of Flat Section
Temperature Rating	-70 to +150°C
Flammability Rating	UL: VW-1; IEEE 383-1974 70,000 BTU
UL Approval	File #E12683, Style 20468
Packaging	100

Electrical Specifications

Voltage Rating	150V RMS
Current Rating	1A
Conductor Resistance	68.2Ω/1000 ft.
Insulation Resistance	>1 x 10 ¹¹ Ω • 10 ft. (3m)
Impedance (Balanced)	145Ω
Impedance* (Unbalanced)	130Ω
Capacitance* (@ 1 MHz)	10.6 pF/ft. (34.78 pF/m)
Inductance* (@ 1 MHz)	.22 μH/ft. (.72 μH/m)
Propagation Delay*	1.32 ns/ft. (4.33 ns/m)

*Test Configuration: G-S (ground-signal), unbalanced.

Part No.	No. of Pairs	Dimensions			
		Width "A"		Span "B"	
		Inch	mm	Inch	mm
8V28010	5	.50	12.70	.45 ±.012	11.43 ±.31
8V28014	7	.70	17.78	.65 ±.012	16.51 ±.31
8V28020	10	1.00	25.40	.95 ±.015	24.13 ±.38
8V28026	13	1.30	33.02	1.25 ±.015	31.75 ±.38
8V28036	18	1.80	45.72	1.75 ±.017	44.45 ±.43
8V28040	20	2.00	50.80	1.95 ±.017	49.53 ±.43
8V28060	30	3.00	76.20	2.95 ±.020	74.93 ±.51

Dimensions

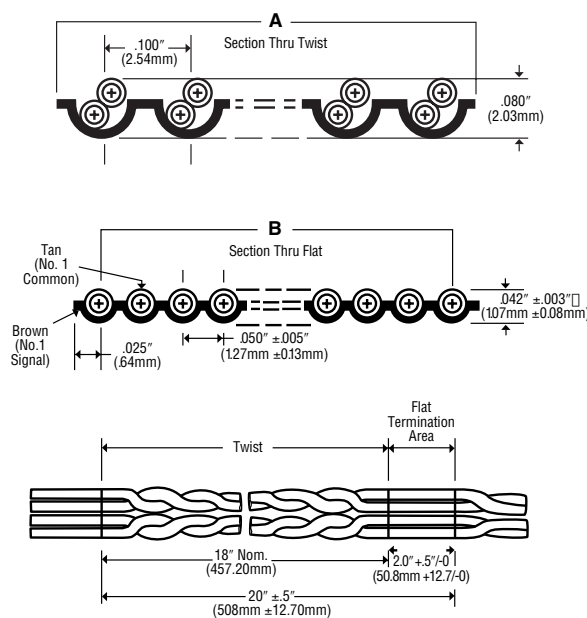

NOTE: the transition area is included in the twisted section to assure a full 2 inches of flat termination area.

Unbalanced Crosstalk*

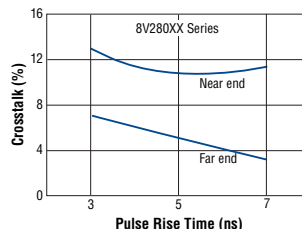

Attenuation*

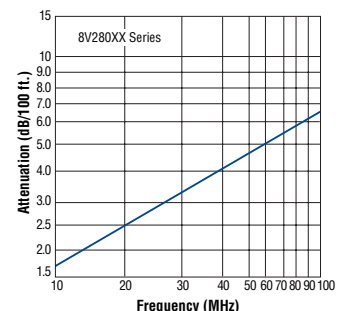

Shielded Jacketed 9L283XX Series

.050" Pitch, 28 AWG, PVC

Product Description

Belden's shielded jacketed 9L283XX series was designed to help meet the FCC EMI/RFI requirements. In addition, the cable provides shielding from external electrical interference along with excellent crosstalk attenuation. The thin extruded jacket allows for greater flexibility, ease of termination, and reduced space requirements, while providing exterior protection from the environment. The core cable is Belden's 9L280XX PVC series allowing easy termination to any standard IDC connector. All cables are 100% shielded with a Duofoil® shield (aluminum/polyester/aluminum) and can be terminated with the two 28 AWG drain wires. Thirteen various conductor counts are standard; other sizes are available upon request. The cable is UL approved and CSA certified, and passes the VW-1 Vertical Wire Flame Test.

Color Code: Gray with Red polarity stripe.

Application: External interconnection or internal wiring of electronic equipment.

Physical Specifications

Conductor	28 AWG (7x36) Tinned Copper
Insulation	.010" Nom. Wall Gray PVC
Pitch	.050" ± .002"
Shielding	Duofoil Shield (Aluminum/Polyester/Aluminum)
Drain Wires	Two 28 AWG (7x36) Tinned Copper
Jacket	.038" Nom. Wall Black PVC
Temperature Rating	-20 to +105°C
Flammability Rating	UL: VW-1; CSA: FT1
UL Approval	File #E12683, Style 20081
CSA Approval	File #LL7874, CSA AWM II A 105°C 300V FT1
Packaging	100

Electrical Specifications

Voltage Rating	300V RMS
Current Rating	1A
Conductor Resistance	68.2Ω/1000 ft.
Insulation Resistance	>1 x 10 ¹⁰ Ω • 10 ft. (3m)
Impedance*	45Ω
Capacitance* (@ 1 MHz)	50 pF/ft. (164 pF/m)
Inductance* (@ 1 MHz)	.11 μH/ft. (.36 μH/m)
Propagation Delay*	1.70 ns/ft. (5.6 ns/m)

*Test Configuration: G-S-G (ground-signal-ground), with shield grounded.

Part No.	No. of Cond.	Dimensions			
		Width "A"		Span "B"	
		Inch	mm	Inch	mm
9L28309	9	.55	13.97	.40 ±.008	10.16 ±.20
9L28310	10	.60	15.24	.45 ±.008	11.43 ±.20
9L28315	15	.85	21.59	.70 ±.008	17.78 ±.20
9L28320	20	1.10	27.94	.95 ±.008	24.13 ±.20
9L28325	25	1.35	34.29	1.20 ±.008	30.48 ±.20
9L28326	26	1.40	35.56	1.25 ±.008	31.75 ±.20
9L28334	34	1.80	45.72	1.65 ±.008	41.91 ±.20
9L28337	37	1.95	49.53	1.80 ±.012	45.72 ±.30
9L28340	40	2.10	53.34	1.95 ±.012	49.53 ±.30
9L28350	50	2.60	66.04	2.45 ±.012	62.23 ±.30
9L28360	60	3.10	78.74	2.95 ±.012	74.93 ±.30

Dimensions

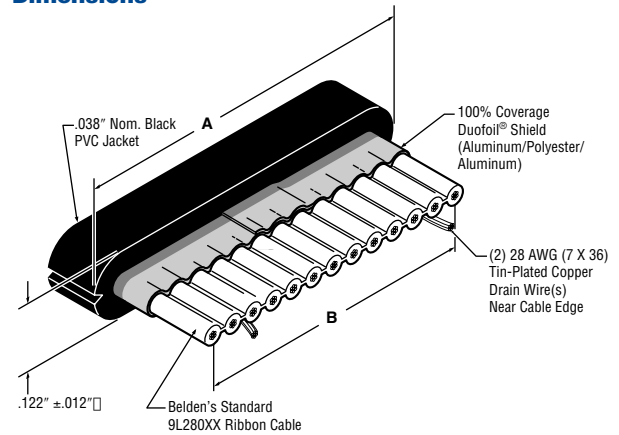

Unbalanced Crosstalk*

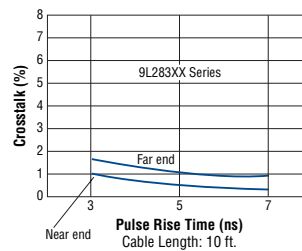

Attenuation*

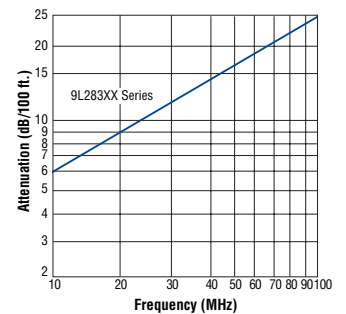

Shielded Jacketed Vari-Twist® 9V283XX Series

.050" Pitch, 28 AWG, PVC

Product Description

Belden's shielded jacketed 9V283XX series was designed to help meet the FCC EMI/RFI requirements. In addition, the cable provides shielding from external electrical interference along with excellent crosstalk attenuation. As with the 9V280XX series, the cable supplies the electrical benefits of twisted pairs, but can be mass-terminated in the programmed flat sections. The thin extruded jacket allows for greater flexibility, ease of termination, reduced space requirements, and identification of the flat sections while providing exterior protection from the environment. The core cable is Belden's 9V280XX PVC series to allow easy termination to any standard IDC connector. All cables are 100% shielded with a Duofoil® shield (aluminum/polyester/aluminum) and can be terminated with the two 28 AWG drain wires. Ten various conductor/pair counts are standard; other sizes are available upon request. The cable is UL approved (CSA available upon request) and passes the VW-1 Vertical Wire Flame Test.

Color Code: Each pair consists of a Tan conductor paired with a color-coded conductor. *Color Sequence Each Terminating Section:* Brown/Tan, Red/Tan, Orange/Tan, Yellow/Tan, Green/Tan, Blue/Tan, Purple/Tan, Gray/Tan, White/Tan, Black/Tan. Sequence is repeated as necessary.

Application: External interconnection or internal wiring of electronic equipment.

Physical Specifications

Conductor	28 AWG (7x36) Tinned Copper
Insulation	.010" Nom. Wall Color-coded PVC
Substrate	.010" Nom. Wall Clear PVC
Pitch	
Twisted Pair Centers:	.100" Nom.
Conductor Centers in Flat:	.050" ± .005"
Pairs	1/2" Nom. Lay
	Adjacent Pairs have Opposite Direction Lay
Construction	18" of Twisted Pairs 2" of Flat Section
Shielding	Duofoil Shield (Aluminum/Polyester/Aluminum)
Drain Wires	Two 28 AWG (7x36) Tinned Copper
Jacket	.038" Nom. Wall Black PVC
Temperature Rating	-20 to +105°C
Flammability Rating	UL: VW-1
UL Approval	File #E12683, Style 20081
CSA Approval	Available Upon Request
Packaging	100

Electrical Specifications

Voltage Rating	300V RMS
Current Rating	1A
Conductor Resistance	68.2Ω/1000 ft.
Insulation Resistance	>1 x 10 ¹⁰ Ω • 10 ft. (3m)
Impedance (Balanced)	100Ω
Impedance* (Unbalanced)	60Ω
Capacitance* (@ 1 MHz)	29 pF/ft. (95 pF/m)
Inductance* (@ 1 MHz)	.13 μH/ft. (.43 μH/m)
Propagation Delay*	1.60 ns/ft. (5.25 ns/m)

*Test Configuration: G-S-G (ground-signal-ground) with shield grounded.

Part No.	No. of Pairs	Dimensions			
		Width "A"		Span "B"	
		Inch	mm	Inch	mm
9V28310	5	.60	15.24	.45 ±.012	11.43 ±.30
9V28314	7	.80	20.32	.65 ±.012	16.51 ±.30
9V28326	13	1.40	35.56	1.25 ±.015	31.75 ±.38
9V28334	17	1.80	45.72	1.65 ±.015	41.91 ±.38
9V28350	25	2.60	66.04	2.45 ±.017	62.23 ±.43

Dimensions

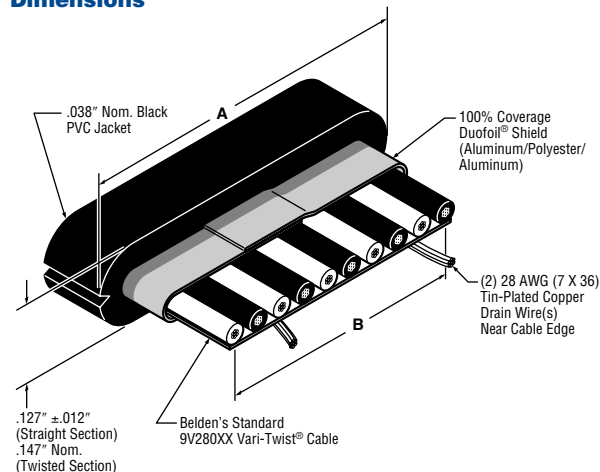

NOTE: the transition area is included in the twisted section to assure a full 2 Inches of flat termination area.

Unbalanced Crosstalk*

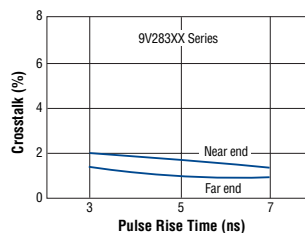

Attenuation*

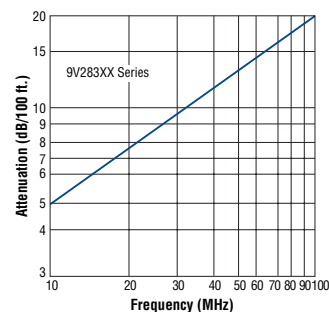

Technical Information

Flat Cable Crosstalk Testing

The following is a description of two methods Belden uses to test its flat cable for crosstalk. Because these methods are different, the results may be different even when the same type of cable is used in each test. In short, the reader is offered two different tests to determine which cable type has the best crosstalk characteristics. At times, the results of these two test methods do not agree. Therefore, it is best for the reader to determine which method most closely approximates actual cable application and use its results for cable comparisons.

Unbalanced Crosstalk

The unbalanced crosstalk of flat cables is measured as shown in Figure 1. One end of the cable drive is connected through an impedance matching device to a signal generator. The other end of the drive line is terminated in its characteristic impedance. The signal generator is capable of generating square wave pulses of varying leading edge rise times.

A test signal from the signal generator is inserted into the drive line. The cable is connected as follows: Ground-Drive line-Ground-Sample line-Ground or GSG mode. The sample line is also terminated at both ends in its characteristic impedance. The signal at each end of the sample line is measured. The signal at the signal generator end of the sample line is called the near end or reverse crosstalk. The signal at the opposite end of the sample line is called the far end or forward crosstalk. The actual crosstalk figures are given in % and are calculated as follows:

$$\% \text{ Crosstalk} = \frac{\text{Signal in sample line}}{\text{Signal in drive line}} \times 100\%$$

This type of crosstalk test is widely accepted in the flat cable industry. It is a very good method to determine the pulse crosstalk of all types of flat cables connected in the GSG mode. Crosstalk data for Belden flat cables tested using this method is given in the electrical data section of each cable.

Figure 1: Unbalanced Near End Crosstalk

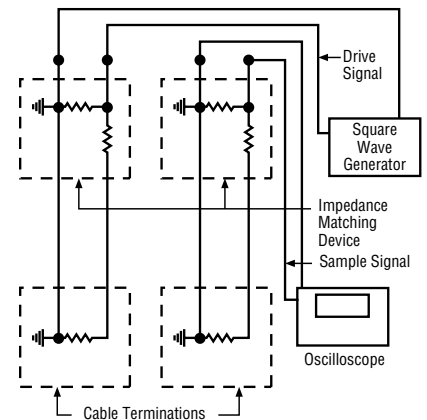

Technical Information

Flat Cable Crosstalk Testing

Balanced Crosstalk

Twisted pair flat cables are not designed to be connected in the GSG mode. These cables provide positive crosstalk reduction over non-twisted pair cables when used in the balanced mode. The balanced crosstalk of twisted pair flat cables is measured as shown in Figure 2. One end of the cable drive pair is connected through a balanced impedance matching transformer to the network analyzer input. The other end of the cable drive pair is terminated in its characteristic impedance. One end of the sample pair is terminated in its characteristic impedance. The other end of the cable sample pair is connected through a balanced impedance matching transformer to the network analyzer output. Because impedance matching transformers are used, none of the wires in the drive or sample line share a common ground. The signal in each line is balanced to ground. For example, one wire of the line will carry the inverse of the signal in the other wire in the same line at any given moment. The signal from the tracking generator is a range of frequencies, typically from 10 MHz to 100 MHz. The signal at each end of the sample line is measured in units of dB of isolation using a spectrum analyzer. The crosstalk results of two cables, one with parallel non-twisted conductors (9L Series) and the other with twisted pair conductors (9V Series) is shown in Figure 3.

In conclusion, it is not the intent of this section to recommend one type of crosstalk testing over another. Rather, it is intended to demonstrate there are different cable types for the different cable applications.

Please choose the crosstalk testing method which most closely approximates your application.

Figure 2: Balanced Near End Crosstalk

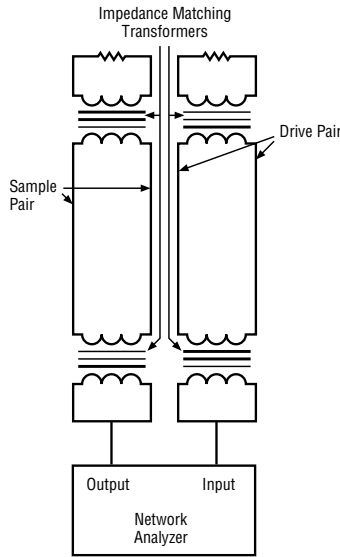
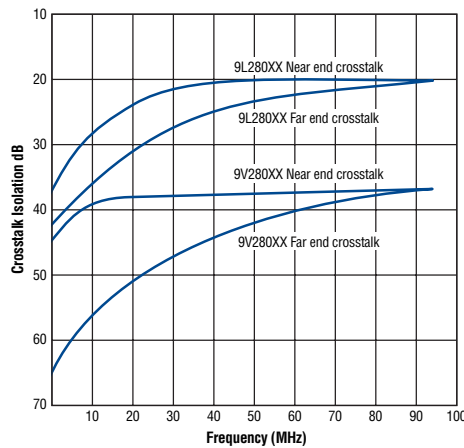

Figure 3: Balanced Crosstalk





Molded Cable Assemblies

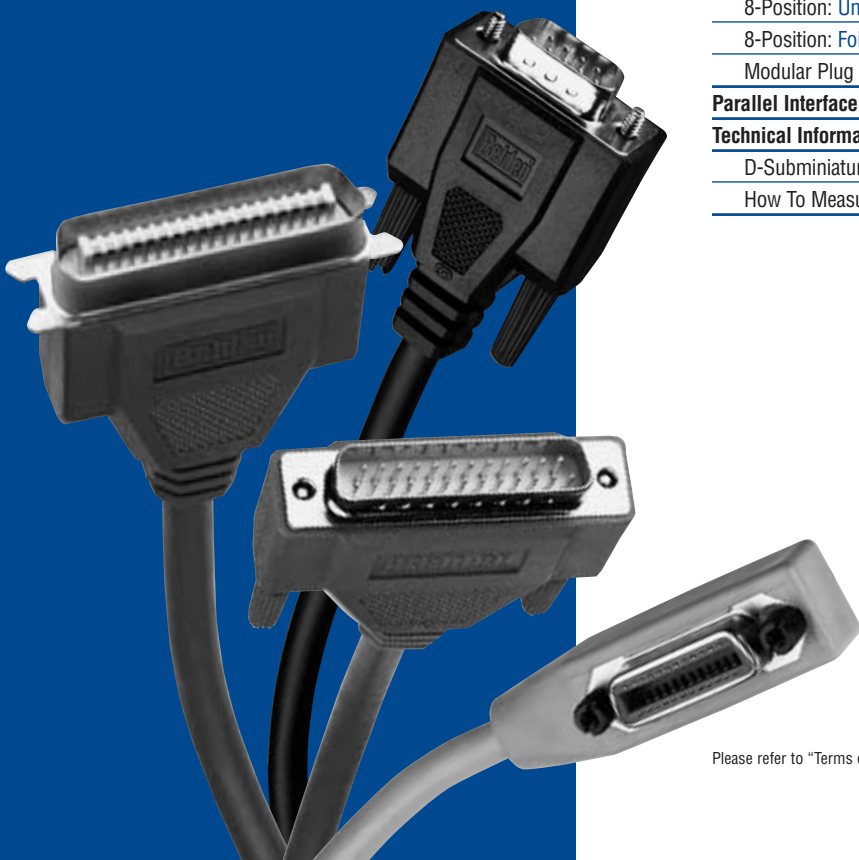

Table of Contents

Molded Cable Assemblies	Page No.
Introduction	8.2
D-Subminiature Assemblies with Straight Handles	8.3–8.5
Shielded 9-Position: Foil Shielded Retractable Cable (handle one end)	8.3
Shielded 9-Position: Foil Shielded Cable	8.3
Shielded 15-Position: Foil Shielded Cable	8.3
Shielded 15-Position: Foil+Braid Shielded Cable	8.3
Shielded 25-Position: Foil Shielded Cable	8.4
Shielded 25-Position: Foil+Braid Shielded Cable	8.4
Shielded 37-Position: Foil+Braid Shielded Cable	8.5
Shielded 50-Position: Foil Shielded Cable	8.5
Shielded SCSI Cable Assembly	8.6
 GPIB Assemblies	8.7
Unshielded Molded PVC Connectors: Foil+Braid Shielded Cable	8.7
Shielded Die-Cast Connectors: Foil+Braid Shielded Cable	8.7
Shielded Molded PVC Connectors: Foil+Braid Shielded Cable	8.7
Shielded DIN Cable Assemblies	8.8–8.9
5-Position: Foil Shielded Cable	8.8
5-Position: Foil+Braid Shielded Cable	8.8
8-Position: Foil Shielded Cable	8.8
5-Position: Foil+Serve Retractable Cable	8.9
DIN Pin Configurations: Face Views	8.9
Modular Keyboard Assemblies	8.10
4-Position: Unshielded Retractable Cable	8.10
6-Position: Unshielded Retractable Cable	8.10
8-Position: Unshielded Retractable Cable	8.10
8-Position: Foil Shielded Retractable Cable	8.10
Modular Plug Wiring Schemes	8.10
Parallel Interface Assembly	8.11
Technical Information	8.12
D-Subminiature Retention Systems	8.12
How To Measure A Molded Cable Assembly	8.12

Introduction

Quality Construction

Belden® molded cable assemblies are designed for long life and reliable performance in a variety of input/output (I/O) and keyboard interface applications. Among the many features of the cable assemblies are these performance-enhancing attributes:

Shielding

Molded handles are 100% shielded (where used) to assist in FCC compliance while guarding against EMI and RFI. Shield continuity is maintained through the entire length of the assembly. The connector shield is connected to both the connector shell and the cable shield. This provides a low resistance ground path to optimize shield performance.

Handles

Straight or right angle handles are available for different connecting situations. Standard molding is PVC.

Connectors

Connectors consist of tin-plated shells with grounding indents on male connectors. Pins and sockets are constructed of brass or phosphor-bronze base with gold selectively plated over nickel.

Retention Systems

Belden offers several types of retention systems. They include:

- **Friction:** Pin/contact force holds connectors mated.
- **Screw:** Retaining screws mate with female screwlocks. Straight handle uses two screws; right angle handle uses one screw. Screws are #4-40 thread of plated steel with stainless steel clips.
- **Slide Lock:** Fingertip-operated slide mechanism holds mated connectors securely. Slide lock clip is stainless steel with plated screw, washer, and hex nut.
- **Spring Latch:** Stainless steel latch mates with latching blocks (special orders only).
- **Jack Screw:** Two captive jacks crews mate securely with female screwlocks. Zinc plated, #4-40 thread screws with large knurled heads for easy fingertip connect/disconnect.

Wiring Patterns

Standard wiring is point-to-point on most assemblies. Special wiring is available upon request.

Cables

For standard assemblies, Belden utilizes three standard cable configurations for tailoring a cable to a specific electrical environment. The cable configurations are as follows:

- **General Purpose Unshielded:** An economical assembly where electrical noise/interference is not a problem.
- **General Purpose Shielded:** An overall foil shielded assembly for use in situations where some noise/interference is experienced or anticipated.
- **Super Shield:** A foil plus braid shield provides extra protection in areas of moderate to heavy noise/interference.

Most of our molded cable assemblies are available from stock in a wide variety of handles, cables, colors, retention systems, and wiring patterns. Many of these are available off the shelf from distributors. If you have a new or unusual application or you cannot find molded cables in this catalog section that meet your technical requirements, contact Technical Support at 1-800-BELDEN-1.

Molded Cable Assemblies Packaging

Unless otherwise indicated, molded cable assemblies are shipped in individual packages or plastic bags with printed part numbers, descriptions and an area to indicate the retail price.

D-Subminiature Assembly

Shielded 9-Position and 15-Position

Part No.	No. of Cond.	Length of Body				Length of Tail				Conductors AWG (stranding) [Dia. in mm]	Shield		Insulation Thickness		Jacket Thickness		Nominal OD	
		Retracted		Extended		Connector End		Other End			Type	Drain Wire	Inch	mm	Inch	mm	Inch	mm
		Inch	mm	Inch	mm	Inch	mm	Inch	mm									

9-Position Shielded D-Sub • Male Straight Handle One End • For keyboard-to-CRT use where 9-pin retractile is desired

Foil Shield (General Purpose) • Retractable • Polypropylene Insulation • Black Polyurethane Jacket

49911A	9	18	457	90	2286	6	152	18	457	26 (19x38) Tinned Copper [.53]	Overall Foil	20 (42x36)	.006	.15	.065	1.65	.250	6.35
--------	---	----	-----	----	------	---	-----	----	-----	--------------------------------	--------------	------------	------	-----	------	------	------	------

Polyurethane jacket provides superior retractile properties at a reasonable cost. Molded handles are 100% shielded to assist in FCC compliance and guard against EMI/RFI. All connectors are tin-plated with detents for a positive ground connection. The end opposite the connector is stripped. Jack screw retention on male connector. 30V 60°C, UL AWM Style 20197

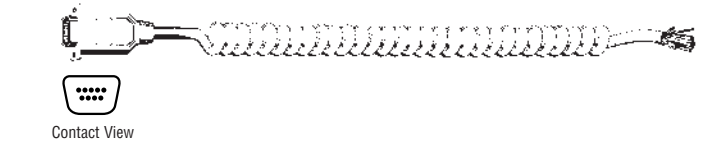

Part No.	No. of Cond.	Standard Lengths		Gender	UL NEC/ (C)UL CEC Type	Conductors AWG (stranding) [Dia. in mm]	Shield		Insulation Thickness		Jacket Thickness		Nominal OD	
		Ft.	m				Type	Drain Wire	Inch	mm	Inch	mm	Inch	mm

9-Position Shielded D-Sub • Straight Handle Both Ends • For RS-449 applications

Foil Shield (General Purpose) • Semi-rigid PVC Insulation • Chrome PVC Jacket

49900A	9	5	1.5	Male/Male	NEC: CM	24 (7x32) Tinned Copper [.61]	Overall Foil	24 (7x32)	.010	.25	.032	.81	.244	6.20
49901A	9	10	3.0	Male/Male										
49902A	9	25	7.6	Male/Male										
49905A	9	5	1.5	Male/Female										
49906A	9	10	3.0	Male/Female										
49907A	9	25	7.6	Male/Female										

Molded handles are 100% shielded to assist in FCC compliance and guard against EMI/RFI. All connectors tin-plated and male connectors have detents for positive ground connection. Wiring is point-to-point with the shield to connector shell. Jack screw retention on both connectors. 300V 80°C, UL AWM Style 2464

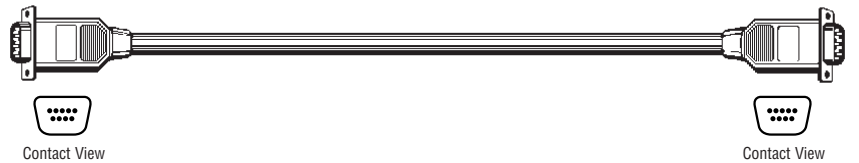

15-Position Shielded D-Sub • Straight Handle Both Ends • For any 15-pin application exposed to high-noise environment

Foil Shield (General Purpose) • Semi-rigid PVC Insulation • Chrome PVC Jacket

49721A	15	10	3.0	Male/Male	NEC: CM	24 (7x32) Tinned Copper [.61]	Overall Foil	24 (7x32)	.010	.25	.032	.81	.284	7.21
49725A	15	5	1.5	Male/Female										
49726A	15	10	3.0	Male/Female										

Molded handles are 100% shielded to assist in FCC compliance and guard against EMI/RFI. All connectors tin-plated and male connectors have detents for positive ground connection. Wiring is point-to-point with the shield to connector shell. Jack screw retention on both connectors. 300V 80°C, UL AWM Style 2464

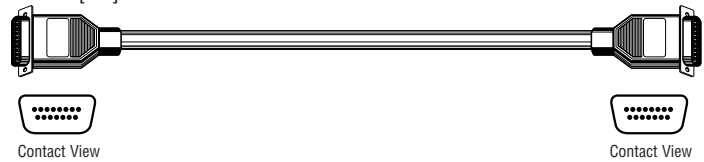

Foil plus Braid Shield (Super Shield) • Semi-rigid PVC Insulation • Chrome PVC Jacket

49740A	15	5	1.5	Male/Male	NEC: CM	24 (7x32) Tinned Copper [.61]	Overall Foil + 65% Braid	None	.010	.25	.035	.89	.300	7.62
49745A	15	5	1.5	Male/Female										
49746A	15	10	3.0	Male/Female										
49747A	15	25	7.6	Male/Female										

Molded handles are 100% shielded to assist in FCC compliance and guard against EMI/RFI. All connectors tin-plated and male connectors have detents for positive ground connection. Wiring is point-to-point with the shield to connector shell. Jack screw retention on both connectors. 300V 80°C, UL AWM Style 2464



D-Subminiature Assembly

Shielded 25-Position

Part No.	No. of Cond.	Standard Lengths		Gender	UL NEC/ (C)UL CEC Type	Conductors AWG (stranding) [Dia. in mm]	Shield		Insulation Thickness		Jacket Thickness		Nominal OD	
		Ft.	m				Type	Drain Wire	Inch	mm	Inch	mm	Inch	mm

25-Position Shielded D-Sub • Straight Handle Both Ends • For RS-232 applications

Foil Shield (General Purpose) • Semi-rigid PVC Insulation • Chrome PVC Jacket

49668A	25	5	1.5	Male/Male	NEC:	24	Overall	24 (7x32)	.010	.25	.032	.81	.339	8.61
49669A	25	10	3.0	Male/Male	CM	(7x32)	Foil							
49673A	25	5	1.5	Male/Female		Tinned Copper								
49674A	25	10	3.0	Male/Female		[.61]								
49675A	25	25	7.6	Male/Female										
49676A	25	50	15.2	Male/Female										

Molded handles are 100% shielded to guard against EMI/RFI where indicated. All connectors are tin-plated and male connectors have detents to allow for a positive shield to ground connection. Wiring is point-to-point with shield to connector shell. Jack screw retention on both connectors.

300V 80°C, UL AWM Style 2464



Foil plus Braid Shield (Super Shield) • Semi-rigid PVC Insulation • Chrome PVC Jacket

49615A	25	5	1.5	Male/Female	NEC:	24	Overall	24 (7x32)						
49616A	25	10	3.0	Male/Female	CM	(7x32)	Foil							
49617A	25	25	7.6	Male/Female		Tinned Copper	+ 65%							
						[.61]	Braid							

Molded handles are 100% shielded to guard against EMI/RFI where indicated. All connectors are tin-plated and male connectors have detents to allow for a positive shield to ground connection. Wiring is point-to-point with shield to connector shell. Jack screw retention on both connectors.

300V 80°C, UL AWM Style 2464



D-Subminiature Assembly

Unshielded 25-Position, Shielded 37-Position and 50-Position

Part No.	No. of Cond.	Standard Lengths		Gender	UL NEC/ (C)UL CEC Type	Conductors AWG (stranding) [Dia. in mm]	Shield		Insulation Thickness		Jacket Thickness		Nominal OD	
		Ft.	m				Type	Drain Wire	Inch	mm	Inch	mm	Inch	mm

37-Position Shielded D-Sub • Straight Handle Both Ends • For RS-449 applications where assembly is exposed to high noise environment

Foil plus Braid Shield (Super Shield) • Semi-rigid PVC Insulation • Chrome PVC Jacket

49950A	36	5	1.5	Male/Male	NEC: 24	Overall	None	.010	.25	.045	1.14	.480	12.19
49951A	36	10	3.0	Male/Male	CM (7x32)	Foil							
49952A	36	25	7.6	Male/Male	Tinned Copper	+ 65%							
49955A	36	5	1.5	Male/Female	[.61]	Tinned							
49956A	36	10	3.0	Male/Female	18 Pairs	Copper							
49957A	36	25	7.6	Male/Female		Braid							

Molded handles are 100% shielded to assist in FCC compliance and guard against EMI/RFI. All connectors are tin-plated and male connectors have detents to allow for a positive shield to ground connection. Wiring is point-to-point with shield to connector shell and pin #1. Jack screw retention on both connectors.

300V 80°C, UL AWM Style 2464

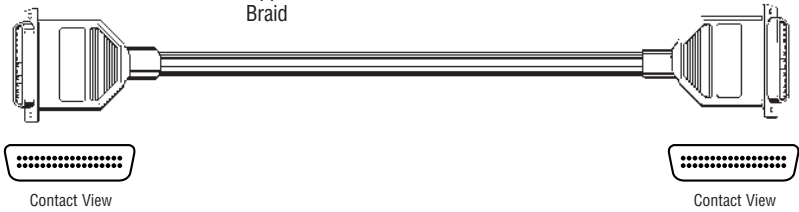

50-Position Shielded D-Sub • Straight Handle Both Ends • For high-density applications where assembly is exposed to high noise environment

Foil plus Braid Shield (General Purpose) • Polyethylene Insulation • Chrome PVC Jacket

49760A	50	5	1.5	Male/Male	NEC: 26	Overall	22 (7x30)	.010	.25	.049	1.24	.535	13.59
49761A	50	10	3.0	Male/Male	CM (7x34)	Foil							
49765A	50	5	1.5	Male/Female	Tinned Copper	+ 91%							
49766A	50	10	3.0	Male/Female	[.48]	Tinned							
					25 Pairs	Copper							
						Braid							

Molded handles are 100% shielded to guard against EMI/RFI and assist in FCC compliance. All connectors are tin-plated and male connectors have detents to allow for a positive shield to ground connection. Wiring is point-to-point with shield to connector shell. Jack screw retention on both connectors.

30V 80°C, UL AWM Style 2919

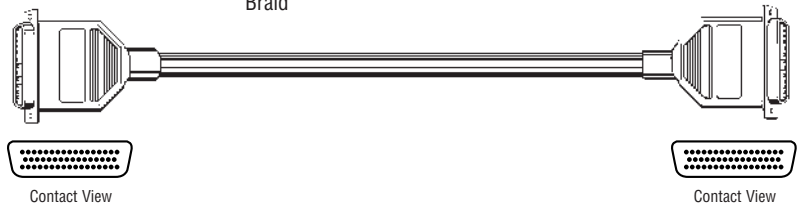

SCSI Cable Assembly

SCSI-1 and SCSI-2

Shielded Straight and Right-Angled Handles

Part No.	No. of Cond.	Standard Lengths		Gender	UL NEC/ (C)UL CEC Type	Conductors AWG (stranding) [Dia. in mm]	Shield		Insulation Thickness		Jacket Thickness		Nominal OD	
		Ft.	m				Type	Drain Wire	Inch	mm	Inch	mm	Inch	mm

SCSI-1 Assemblies (26 AWG) • Shielded Straight Handles • For SCSI (Small Computer Systems Interface) applications

Foil plus Braid Shield (Super Shield) • Polyethylene Insulation • Chrome PVC Jacket

49802A	50	16.4	5	Male/Male	NEC: CM	26 (7x34) Tinned Copper [.48] 25 Pairs	Overall Foil + 90% Braid	22 (7x30) TC	.01	.254	.049	1.245	.535	13.589
---------------	----	------	---	-----------	------------	--	-----------------------------------	--------------------	-----	------	------	-------	------	--------

Molded handles are 100% shielded to guard against EMI/RFI and assist in FCC compliance. These assemblies have tin-plated connectors and can be used in single-ended or differential configurations. Wiring is per SCSI standard.

30V 80°C, UL AWM Style 2919

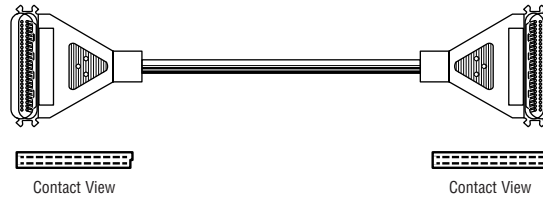

GPIOB (General Purpose Interface Bus) Assembly

Unshielded and Shielded Connectors

Part No.	No. of Cond.	Standard Lengths		Gender	UL NEC/ (C)UL CEC Type	Conductors AWG (stranding)	Shield		Insulation Thickness		Jacket Thickness		Nominal OD	
		Ft.	m				Type	Drain Wire	Inch	mm	Inch	mm	Inch	mm

Unshielded GPIOB • Molded PVC Connector • For use with electronic equipment that is IEEE-488 compatible

Foil plus Braid Shield (Super Shield) • Semi-rigid PVC Insulation • Gull Gray PVC Jacket

49642	23	3.3	1	Male/Female Each End	NEC: CM	6 Pairs: 26 (7x34) TC 10 Singles: 26 (7x34) TC	Overall Foil + 90% Braid	26 (7x34)	.010	.25	.035	.89	.350	8.89
49643	23	6.6	2	Male/Female Each End		1 Single: 24 (7x32) TC								
49645	23	26.2	8	Male/Female Each End										

Molded connector is male/female design for easy stacking and comes with molded-in metric jack screws.
300V 80°C, UL AWM Style 2464



Shielded GPIOB • Die Cast Connector • For use with electronic equipment that is IEEE-488 compatible

Foil plus Braid Shield (Super Shield) • Semi-rigid PVC Insulation • Gull Gray PVC Jacket

49635	23	3.3	1	Male/Female Each End	NEC: CM	6 Pairs: 26 (7x34) TC 10 Singles: 26 (7x34) TC	Overall Foil + 90% Braid	26 (7x34)	.010	.25	.035	.89	.350	8.89
49636	23	6.6	2	Male/Female Each End		1 Single: 24 (7x32) TC								
49637	23	9.8	3	Male/Female Each End										

Die cast connector is male/female design for easy stacking and comes with molded-in metric jack screws.
300V 80°C, UL AWM Style 2464



Shielded GPIOB • Molded PVC Connector • For use with electronic equipment that is IEEE-488 compatible

Foil plus Braid Shield (Super Shield) • Semi-rigid PVC Insulation • Gull Gray PVC Jacket

49733	23	1.6	.5	Male/Female Each End	NEC: CM	6 Pairs: 26 (7x34) TC 10 Singles: 26 (7x34) TC	Overall Foil + 90% Braid	26 (7x34)	.010	.25	.035	.89	.350	8.89
49734	23	3.3	1	Male/Female Each End		1 Single: 24 (7x32) TC								
49735	23	6.6	2	Male/Female Each End										
49736	23	9.8	3	Male/Female Each End										
49737	23	13.1	4	Male/Female Each End										

Molded connector is male/female design for easy stacking and comes with molded-in metric jack screws.
300V 80°C, UL AWM Style 2464



TC = Tinned Copper

DIN* Cable Assembly

Shielded 3-Position, 5-Position and 8-Position

Part No.	No. of Cond.	Standard Lengths		UL NEC/ (C)UL CEC Type	Conductors AWG (stranding) [Dia. in mm]	Shield		Insulation Thickness		Jacket Thickness		Nominal OD	
		Ft.	m			Type	Drain Wire	Inch	mm	Inch	mm	Inch	mm

5-Position Shielded DIN • Straight Handle One End • Used where a shielded conductor is desired and as a low cost alternative to a D-Sub

Foil Shield (General Purpose) • PVC Insulation • Black PVC Jacket

49152A	5	10	3.0	NEC: CM	26 (19x38) Tinned Copper [.51]	Overall Foil	26 (19x38)	.014	.36	.053	1.35	.251	6.38
---------------	---	----	-----	---------	--------------------------------	--------------	------------	------	-----	------	------	------	------

Foil shielded for moderate-noise environments.
Outer jacket stripped 1 inch.
300V 80°C, UL AWM Style 2464. Packaged: B-25, S-25



Foil plus Braid Shield (Super Shield) • PVC Insulation • Black PVC Jacket

49153A	5	10	3.0	NEC: CM	26 (19x38) Tinned Copper [.51]	Overall Foil + 90% Tinned Copper Braid	26 (19x38)	.014	.36	.037	.94	.231	5.87
---------------	---	----	-----	---------	--------------------------------	--	------------	------	-----	------	-----	------	------

Foil and braid shielded for high-noise environments.
Outer jacket stripped 1 inch.
300V 80°C, UL AWM Style 2464. Packaged: B-25, S-25



8-Position Shielded DIN • Straight Handle One End • Used where a shielded conductor is desired and as a low cost alternative to a D-Sub

Foil Shield (General Purpose) • PVC Insulation • Black PVC Jacket

49154A	8	10	3.0	NEC: CM	26 (19x38) Tinned Copper [.51]	Overall Foil	26 (19x38)	.014	.36	.052	1.32	.266	6.76
---------------	---	----	-----	---------	--------------------------------	--------------	------------	------	-----	------	------	------	------

Foil shielded for moderate-noise environments.
Outer jacket stripped 1 inch.
300V 80°C, UL AWM Style 2464. Packaged: B-25, S-25



*DIN Standard (Deutsche Industries Norm)

DIN* Cable Assembly

Shielded 5-Position and 8-Position Retractable

Part No.	No. of Cond.	Length of Body				Length of Tail				Conductors AWG (stranding) [Dia. in mm]	Shield		Insulation Thickness		Jacket Thickness		Nominal OD	
		Retracted		Extended		Connector End		Other End			Type	Drain Wire	Inch	mm	Inch	mm	Inch	mm
		Inch	mm	Inch	mm	Inch	mm	Inch	mm									

5-Position Shielded DIN • Straight Handle • Standard friction-fit connectors mate easily with many microcomputer keyboard ports

Foil plus Serve Shield (Super Shield) • Retractable • PVC Insulation • Black PVC Jacket

49103A	5	14.5	368.3	72.5	1841.5	12	304.8	18	457.20	26 (19x38)	Foil + 95% Tinned Copper Serve [51]	26 (19x38)	.014	.36	.058	1.47	.260	6.60
---------------	---	------	-------	------	--------	----	-------	----	--------	------------	-------------------------------------	------------	------	-----	------	------	------	------

Shielded connectors maintain shield integrity and assist in FCC compliance. Utilizes 26 AWG conductor for low voltage drop. Ideal for higher noise situations. 300V 80°C, UL AWM Style 2464. Packaged: S-25



NEC: CM

DIN Pin Configurations • Face Views



**Available by special order

*DIN Standard (Deutsche Industries Norm)

Modular Keyboard Assemblies

4-Position, 6-Position and 8-Position with Retractable Cables
Unshielded or Shielded Modular Plugs

Part No.	No. of Cond.	Length of Cord						Conductors AWG (stranding) [Dia. in mm]	Shield		Insulation Thickness		Jacket Thickness		Nominal OD	
		Body Retracted		Body Extended		Tail Length			Type	Drain Wire	Inch	mm	Inch	mm	Inch	mm
		Inch	mm	Inch	mm	Inch	mm									

4-Position Modular Plugs • Used to rapidly interconnect electronic computers and business machines

Unshielded (General Purpose) • Retractable • Polypropylene Insulation • Black or CRT White Polyurethane Jacket

49440	4	15	381	67.5	1714.50	1	25.40	26 (19x38) Tinned Copper [.51]	None	None	.006	.15	.030	.76	.093	2.36
Positive locking latch prevents connector from vibrating loose. Polarized connector prevents improper insertion. No tools required for installation.															x	x
30V 60°C, UL AWM Style 20197. Packaged: B-25, S-25															.198	5.03

6-Position Modular Plugs • Used to rapidly interconnect electronic computers and business machines

Unshielded (General Purpose) • Retractable • Polypropylene Insulation • Black Polyurethane Jacket

49441	6	15	381	67.5	1714.50	1	25.40	26 (19x38) Tinned Copper [.51]	None	None	.006	.15	.030	.76	.093	2.36
Positive locking latch prevents connector from vibrating loose. Polarized connector prevents improper insertion. No tools required for installation.															x	x
30V 60°C, UL AWM Style 20197. Packaged: B-25, S-25															.258	6.55

8-Position Modular Plugs • Used to rapidly interconnect electronic computers and business machines

Unshielded (General Purpose) • Retractable • Polypropylene Insulation • Black or CRT White Polyurethane Jacket

49442	8	15	381	67.5	1714.50	1	25.40	26 (19x38) Tinned Copper [.51]	None	None	.006	.15	.030	.76	.100	2.54
Positive locking latch prevents connector from vibrating loose. Polarized connector prevents improper insertion. No tools required for installation.															x	x
30V 60°C, UL AWM Style 20197. Packaged: B-25, S-25															.314	7.98

Foil Shield* • Retractable • Polypropylene Insulation • Black Polyurethane Jacket

49402	7	15	381	67.5	1714.50	1	25.40	26 (19x38) Tinned Copper [.51]	Foil	26 (19x38)	.006	.15	.030	.76	.100	2.54
Positive locking latch prevents connector from vibrating loose. Polarized connector prevents improper insertion. No tools required for installation. A longitudinal aluminum/polyester shield protects against ESD and EMI.															x	x
30V 60°C, UL AWM Style 20197. Packaged: S-25															.314	7.98



Contact View



Contact View

Modular Plug Wiring Schemes

Cross wiring is standard on non-shielded constructions

1.....	4
2.....	3
3.....	2
4.....	1

Straight wiring is standard on shielded constructions

1.....	1
2.....	2
3.....	3
4.....	4

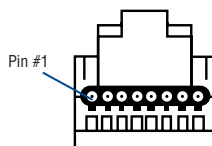

*In shielded versions, the drain wire is always the highest numbered position in the connector.

Parallel Interface Assembly

Part No.	No. of Cond.	Standard Lengths		Gender	UL NEC/ (C)UL CEC Type	Conductors AWG (stranding) [Dia. in mm]	Shield		Insulation Thickness		Jacket Thickness		Nominal OD	
		Ft.	m				Type	Drain Wire	Inch	mm	Inch	mm	Inch	mm

Parallel Interface Assemblies • Centronics/D-Sub Connectors • For computer-printer parallel interface

Shielded • Foil plus Braid Shield (Super Shield) • Semi-rigid PVC Insulation • Chrome PVC Jacket

49502A	25	10	3.0	Male/Male	NEC: CM	24 (7x32) Tinned Copper [.61]	Overall Foil + 65% Tinned Copper Braid	None	.010	.25	.040	1.02	.370	9.40
---------------	----	----	-----	-----------	------------	--	---	------	------	-----	------	------	------	------

Universal 36-position ribbon connector (Centronics compatible) on one end and a 25-position D-Subminiature connector (IBM PC and PC-XT compatible) on the other. Molded handles are 100% shielded to guard against EMI/RFI and assist in FCC compliance.

300V 80°C, UL AWM Style 2464

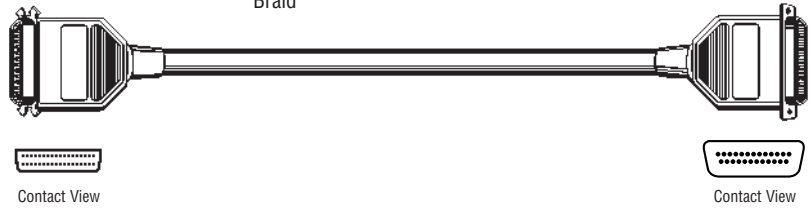

Technical Information

D-Subminiature Retention Systems

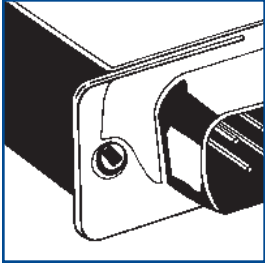

Friction

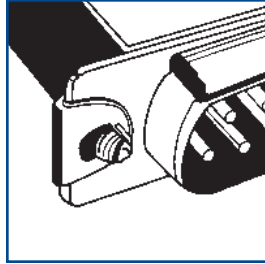

Screw

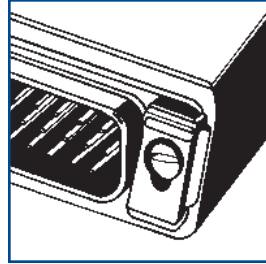

Vertical Slide Lock

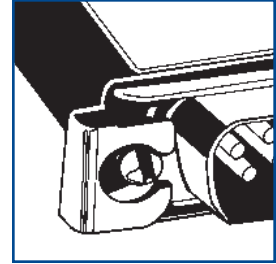

Horizontal Slide Lock

How to Measure a Molded Cable Assembly



Length
Straight Handled Connector



Length
Angled Handled Connector



Length
GPIB



Length
DIN

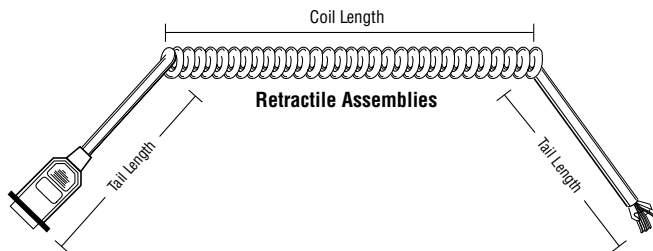

Coil Length
Retractile Assemblies
Tail Length



Portable Cordage

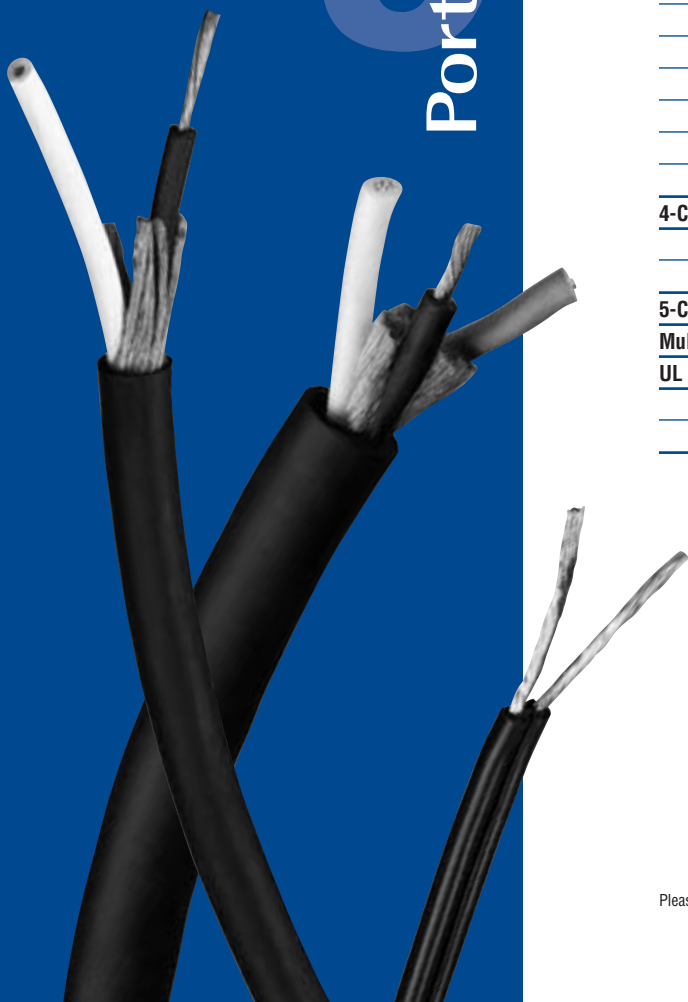

Table of Contents

Portable Cordage	Page No.
Introduction	9.2
2-Conductor	9.3–9.5
SPT-1 Type: PVC Parallel Lamp Cord	9.3
SPT-2 Type: PVC Parallel Lamp Cord	9.3
SP-1 Type: Rubber Parallel Lamp Cord	9.3
HPN Type: CPE Heater Cord	9.3
SJ Type: Rubber Jacket	9.4
SJO Type: Oil-Resistant Rubber Jacket	9.4
SJTOW Type: Belflex® PVC Jacket	9.4
SO Type: Oil-Resistant Rubber Jacket	9.4
STOW Type: Belflex PVC Jacket	9.5
SV Type: Rubber Jacket	9.5
SVT Type: PVC Jacket	9.5
3-Conductor	9.6–9.9
S Type: Rubber Jacket	9.6
SO Type: Oil-Resistant Rubber Jacket	9.6
SJ Type: Rubber Jacket	9.6
SJO Type: Oil-Resistant Rubber Jacket	9.7
SJT Type: PVC Jacket	9.7
SJT Type: PVC Jacket, Shielded	9.7
SJT Type: PVC Jacket Low Leakage Power Cord	9.7
SJTOW Type: Belflex PVC Jacket	9.8
STOW Type: Belflex PVC Jacket	9.8
SV Type: Rubber Jacket	9.8
SVT Type: PVC Jacket	9.8
SVT Type: PVC Jacket, Shielded	9.9
4-Conductor	9.9
Rubber Jacket	9.9
SO Type: Oil-Resistant Rubber Jacket	9.9
5-Conductor: Rubber Jacket	9.9
Multi-Conductor: SO Type: Oil-Resistant Rubber Jacket	9.10
UL Cordage Types	9.11–9.12
Designation Chart	9.11
Construction and Rating Chart	9.12

Introduction

Belden® portable cordage products are available in a wide assortment of styles, lengths, and thicknesses. Products offered include 2-, 3-, 4- and 5-conductor as well as multi-conductor constructions. Jacket options include PVC, Rubber, Oil-Resistant Rubber and Belflex®. Belflex is a premium PVC jacket compound (Class 43) that is superior to standard PVC for flexibility and durability.

Belden portable cordage is listed by Underwriters Laboratories Inc. (UL). This approval signifies that Underwriters Laboratories Inc. has approved all elements of the cordage as meeting their applicable construction and performance standards. Where indicated, “Certified to CSA Standards” means that Belden portable cordage has been certified by CSA as meeting their Label Service or Re-examination Service requirements. Certification under the applicable CSA Standards has been made mandatory by most provincial or municipal authorities in Canada.

Most of our portable cordage constructions are available from stock. Many of these are available off the shelf from distributors. If you have a new or unusual application or you cannot find portable cordage in this catalog section that meets your technical requirements, contact Technical Support at 1-800-BELDEN-1.

Color Code Comparison by Function

Color Coding		Function
International	North American Standards	
Light Blue	White	N-Neutral
Brown	Black	L-Live
Green/Yellow	Green or Green/Yellow	E-Earth or Ground

Manufacturer’s Identification

Identification of the flexible cord is provided by our UL and CSA file numbers or printed name on the cord jacket.

UL/CSA File Numbers

UL: E-3462

CSA: LL-7874

Portable Cordage Packaging

Belden’s unique UnReel® cable dispenser is available for many of the portable cordage products listed in this section. The letter “U” before the specified put-up length denotes UnReel packaging.

2-Conductor

UL/CSA Types: SPT-1, SPT-2, SP-1 and HPN

Description	Part No.	Standard Lengths		Standard Unit Weight		Jacket Color	Conductor AWG (stranding)	Nom. Insulation Thickness		Nom. Jacket Thickness		Nominal OD	
		Ft.	m	Lbs.	kg			Inch	mm	Inch	mm	Inch	mm

SPT-1 PVC Parallel Lamp Cord • UL/CSA Listed

300V, 60°C • One Conductor Polarity Ribbed													
	19122	250 [†]	76.2	5.8	2.6	Brown, White, Black, Silver-Gray	18 (42x34) BC	.032	.81	—	—	.110	2.79
		1000 ^{††}	304.8	21.0	9.5							x	x
	8888*	250	76.2	5.5	2.5	Brown	18 (42x34) BC	.032	.81	—	—	.110	2.79
		U-1000	U-304.8	21.0	9.5							x	x
								Brown, Gray					

SPT-2 PVC Parallel Lamp Cord • UL/CSA Listed

300V, 60°C • One Conductor Polarity Ribbed													
	19123	250 [†]	76.2	7.8	3.5	Brown, White, Black	18 (42x34) BC	.049	1.24	—	—	.144	3.66
												x	x
	19126	250 [†]	76.2	9.8	4.4	Brown, Black	16 (65x34) BC	.048	1.22	—	—	.155	3.94
												x	x

SP-1 Rubber Parallel Lamp Cord • UL Listed

300V, 60°C • One Conductor Polarity Ribbed													
	19115*	250 [†]	76.2	6.8	3.1	Brown, Black	18 (41x34) BC	.035	.89	—	—	.123	3.12
												x	x

HPN CPE Heater Cord • UL/CSA Listed

300V, 90°C													
	19405	250 [†]	76.2	7.8	3.5	Black	18 (41x34) BC	.047	1.18	—	—	.140	3.56
		1000 [†]	304.8	31.0	14.1							x	x
	19404	250 [†]	76.2	9.8	4.4	Black	16 (105x36) BC	.047	1.18	—	—	.152	3.86
		1000 [†]	304.8	39.0	17.7							x	x

BC = Bare Copper • CPE = Chlorinated Polyethylene

*Not CSA recognized.

[†]Put-ups may contain more than one piece. Minimum length of any one piece is 50 ft.

^{††}Put-ups may contain more than one piece. Minimum length of any one piece is 100 ft.

2-Conductor

UL/CSA Types: SJ, SJO, SJTOW, SO

Description	Part No.	Standard Lengths		Standard Unit Weight		Jacket Color	Conductor AWG (stranding)	Nom. Insulation Thickness		Nom. Jacket Thickness		Nominal OD	
		Ft.	m	Lbs.	kg			Inch	mm	Inch	mm	Inch	mm

SJ Rubber Jacket • Smooth Jacket • UL/CSA Listed

300V, 60°C • Paper Tape Separator • Color Code: Black, White

	8478	250	76.2	10.8	4.9	Black	18 (42x34) BC	.032	.81	.035	.89	.290	7.37
		1000	304.8	48.0	21.8								
	8472	250	76.2	12.8	5.8	Black	16 (65x34) BC	.033	.84	.035	.89	.315	8.00

SJO Oil-Resistant Rubber Jacket • Smooth Jacket • UL/CSA Listed

300V, 90°C • Paper Tape Separator • Color Code: Black, White

	19227	250 [†]	76.2	11.0	5.0	Black	18 (16x30) BC	.031	.79	.035	.89	.290	7.37
	19228	250 [†]	76.2	13.5	6.1	Black	16 (26x30) BC	.031	.79	.035	.89	.315	8.00

SJTOW Belflex® Matte Black Premium PVC • Smooth Jacket • UL/CSA Listed

300V, 105°C • Paper Tape Separator • International Color Code: Light Blue, Brown

	19506*	250	76.2	11.0	5.0	Matte Black	18 (42x34) BC	.032	.81	.035	.89	.290	7.34
	19507*	250	76.2	13.5	6.1	Matte Black	16 (65x34) BC	.033	.84	.037	.94	.319	8.10
	19508*	250	76.2	17.0	7.7	Matte Black	14 (41x30) BC	.033	.84	.032	.81	.348	8.84

SO Oil-Resistant Rubber Jacket • Smooth Jacket • UL/CSA Listed

600V, 90°C • Cotton Serve Separator • Color Code: Black, White

	19204	250 [†]	76.2	18.5	8.4	Black	18 (42x34) BC	.032	.81	.065	1.65	.360	9.14
	19203	250 [†]	76.2	19.0	8.6	Black	16 (65x34) BC	.033	.84	.065	1.65	.385	9.78
	19202	250 [†]	76.2	37.3	16.9	Black	14 (41x30) BC	.048	1.22	.085	2.16	.523	13.28

600V, 90°C • Paper Tape Separator • Color Code: Black, White

	19201	250 [†]	76.2	52.8	24.0	Black	12 (65x30) BC	.051	1.30	.100	2.54	.610	15.49
--	--------------	------------------	------	------	------	-------	---------------------	------	------	------	------	------	-------

BC = Bare Copper

*These constructions are approved as water-resistant, oil-resistant and for outdoor use.

[†]Put-ups may contain more than one piece. Minimum length of any one piece is 50 ft.

2-Conductor

UL/CSA Types: STOW, SV, SVT

Description	Part No.	Standard Lengths		Standard Unit Weight		Jacket Color	Conductor AWG (stranding)	Nom. Insulation Thickness		Nom. Jacket Thickness		Nominal OD	
		Ft.	m	Lbs.	kg			Inch	mm	Inch	mm	Inch	mm

STOW Belflex® Matte Black Premium PVC • Smooth Jacket • UL/CSA Listed

600V, 105°C • Paper Tape Separator • International Color Code: Light Blue, Brown

	19500*	250	76.2	16.0	7.3	Matte Black	18 (42x34) BC	.032	.81	.070	1.78	.360	9.14
	19501*	250	76.2	18.8	8.5	Matte Black	16 (65x34) BC	.033	.84	.070	1.78	.386	9.80
	19502*	250	76.2	34.0	15.5	Matte Black	14 (41x30) BC	.049	1.24	.089	2.26	.524	13.31

SV Rubber Jacket • Serrated Jacket • UL/CSA Listed

300V, 60°C • Cotton Serve Separator • Color Code: Black, White

	8452	250	76.2	9.5	4.3	Black	18 (42x34) BC	.017	.43	.037	.94	.245	6.22
		U-500	U-152.4	18.5	8.4								
		500	152.4	17.0	7.7								
		U-1000	U-304.8	36.0	16.3								
		1000	304.8	38.0	17.3								

SV Rubber Jacket • Smooth Jacket • UL/CSA Listed

300V, 60°C • Cotton Serve Separator • Color Code: Black, White

	19120	250 [†]	76.2	8.8	4.0	Black	18 (42x34) BC	.017	.43	.037	.94	.245	6.22

SVT PVC Jacket • Serrated Jacket • UL/CSA Listed

300V, 60°C • Paper Tape Separator • Color Code: Black, White

	19140	250 [†]	76.2	8.8	4.0	Black, Gray	18 (42x34) BC	.018	.46	.036	.91	.243	6.17

BC = Bare Copper

*These constructions are approved as water-resistant, oil-resistant and for outdoor use.

[†]Put-ups may contain more than one piece. Minimum length of any one piece is 50 ft.

3-Conductor

UL/CSA Types: S, SO, SJ

Description	Part No.	Standard Lengths		Standard Unit Weight		Jacket Color	Conductor AWG (stranding)	Nom. Insulation Thickness		Nom. Jacket Thickness		Nominal OD	
		Ft.	m	Lbs.	kg			Inch	mm	Inch	mm	Inch	mm

S Rubber Jacket • Smooth Jacket • UL/CSA Listed

600V, 60°C • Cotton Serve Separator • Color Code: Black, White, Green

	19109	250 [†]	76.2	18.8	8.5	Black	18 (42x34) BC	.032	.81	.065	1.65	.380	9.65
	19108	250 [†]	76.2	27.5	12.5	Black	16 (65x34) BC	.033	.84	.065	1.65	.405	10.29

600V, 60°C • Paper Tape Separator • Color Code: Black, White, Green

	19107	250 [†]	76.2	42.3	19.2	Black	14 (41x30) BC	.048	1.22	.085	2.16	.535	13.59
	19106	250 [†]	76.2	61.8	28.1	Black	12 (65x30) BC	.051	1.30	.099	2.51	.640	16.26
	19105	250 [†]	76.2	78.0	35.5	Black	10 (105x30) BC	.050	1.27	.099	2.51	.681	17.30

SO Oil-Resistant Rubber Jacket • Smooth Jacket • UL/CSA Listed

600V, 90°C • Cotton Serve Separator • Color Code: Black, White, Green

	19209	250 [†]	76.2	19.3	8.8	Black	18 (42x34) BC	.032	.81	.065	1.65	.380	9.65
	19208	250 [†]	76.2	26.5	12.0	Black	16 (65x34) BC	.033	.84	.063	1.60	.400	10.16

600V, 90°C • Paper Tape Separator • Color Code: Black, White, Green

	19207	250 [†]	76.2	43.5	19.7	Black	14 (41x30) BC	.048	1.22	.086	2.18	.538	13.67
	19206	250 [†]	76.2	62.8	28.5	Black	12 (65x30) BC	.051	1.30	.100	2.54	.632	16.05
	19205	250 [†]	76.2	79.3	36.0	Black	10 (105x30) BC	.050	1.27	.099	2.51	.681	17.30

SJ Rubber Jacket • Smooth Jacket • UL/CSA Listed

300V, 60°C • Paper Tape Separator • Color Code: Black, White, Green

	19129	250 [†]	76.2	13.8	6.3	Black	18 (16x30) BC	.031	.79	.039	.99	.315	8.00
	19125	250 [†]	76.2	13.5	6.1	Black	18 (42x34) BC	.032	.81	.038	.97	.315	8.00
	19130	250 [†]	76.2	17.5	7.9	Black	16 (26x30) BC	.031	.79	.038	.97	.340	8.64
	19124	250 [†]	76.2	16.5	7.5	Black	16 (65x34) BC	.033	.84	.038	.97	.340	8.64
	8479	250	76.2	7.8	3.5	Black	14 (41x30) BC	.031	.79	.039	.99	.380	9.65

BC = Bare Copper

[†]Put-ups may contain more than one piece. Minimum length of any one piece is 50 ft.



3-Conductor

UL/CSA Types: SJO, SJT

Description	Part No.	Standard Lengths		Standard Unit Weight		Jacket Color	Conductor AWG (stranding)	Nom. Insulation Thickness		Nom. Jacket Thickness		Nominal OD	
		Ft.	m	Lbs.	kg			Inch	mm	Inch	mm	Inch	mm

SJO Oil-Resistant Rubber Jacket • Smooth Jacket • UL/CSA Listed

300V, 90°C • Paper Tape Separator • Color Code: Black, White, Green

	19229	250 [†]	76.2	14.3	6.5	Black	18 (16x30) BC	.031	.79	.039	.99	.315	8.00
	19230	250 [†]	76.2	17.8	8.1	Black	16 (26x30) BC	.031	.79	.038	.97	.340	8.64

SJT PVC Jacket • Serrated Jacket • UL/CSA Listed

300V, 60°C • Paper Tape Separator • Color Code: Black, White, Green (18 AWG); Black, White, Green/Yellow (16 AWG)

	19348	250 [†]	76.2	17.3	7.8	Gray, Black	18 (42x34) BC	.032	.81	.046	1.17	.328	8.33
	19349	250 [†]	76.2	18.3	8.3	Gray, Black	16 (65x34) BC	.033	.83	.038	.97	.340	8.64

SJT PVC Jacket • Smooth Jacket • UL/CSA Listed

300V, 60°C • Paper Tape Separator • International Color Code: Light Blue, Brown, Green/Yellow

	19352	250	76.2	17.5	8.0	Black	18 (42x34) BC	.032	.81	.046	1.17	.328	8.33
	19353	250	76.2	20.0	9.1	Black	16 (65x34) BC	.033	.84	.036	.91	.353	8.97
	19354	250	76.2	25.0	11.4	Black	14 (41x30) BC	.033	.84	.038	.97	.380	9.65

SJT PVC Jacket • Shielded • Smooth Jacket • 20 AWG Drain Wire (7x28) • UL/CSA Listed

300V, 60°C Shielded • Beldfoil® Shield (100% Coverage) • International Color Code: Light Blue, Brown, Green/Yellow

	19362	250	76.2	17.3	7.8	Black	18 (42x34) BC	.032	.81	.050	1.27	.340	8.64
		500	152.4	35.0	15.9								
	19363	250	76.2	21.3	9.7	Black	16 (65x34) BC	.033	.84	.047	1.19	.365	9.27
19364	250	76.2	26.3	11.9	Black	14 (41x30) BC	.033	.84	.042	1.07	.402	10.21	

SJT PVC Jacket • Low Leakage Power Cord • Smooth Jacket • UL Listed

300V, 75°C • Paper Tape Separator • Color Code: Black, White, Green

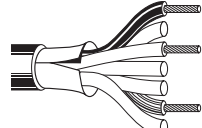
	9998*	500 ^{††}	152.4	55.5	25.2	Gray	16 (65x34) Bare Copper	.033	.84	.045	1.14	.475	12.07
		1000 ^{††}	304.8	107.0	48.5	Lt. Blue							

BC = Bare Copper

*Not CSA recognized.

[†]Put-ups may contain more than one piece. Minimum length of any one piece is 50 ft.

^{††}Put-ups may contain more than one piece. Minimum length of any one piece is 100 ft.

3-Conductor

UL/CSA Types: SJTOW, STOW, SV, SVT

Description	Part No.	Standard Lengths		Standard Unit Weight		Jacket Color	Conductor AWG (stranding)	Nom. Insulation Thickness		Nom. Jacket Thickness		Nominal OD	
		Ft.	m	Lbs.	kg			Inch	mm	Inch	mm	Inch	mm

SJTOW Belflex® Premium PVC • Smooth Jacket • UL/CSA Listed

300V, 105°C • Paper Tape Separator • International Color Code: Light Blue, Brown, Green/Yellow													
	19509*	250	76.2	14.0	6.4	Matte Black	18 (42x34) BC	.032	.81	.038	.97	.315	8.00
	19510*	250	76.2	17.5	7.9	Matte Black	16 (65x34) BC	.033	.84	.038	.97	.340	8.64
	19511*	250	76.2	23.8	10.8	Matte Black	14 (41x30) BC	.032	.81	.040	1.02	.380	9.65

STOW Belflex Premium PVC • Smooth Jacket • UL/CSA Listed

600V, 105°C • Paper Tape Separator • International Color Code: Light Blue, Brown, Green/Yellow													
	19503*	250	76.2	19.0	8.6	Matte Black	18 (42x34) BC	.032	.81	.070	1.78	.380	9.65
	19504*	250	76.2	23.0	10.5	Matte Black	16 (65x34) BC	.033	.84	.070	1.78	.405	10.29
	19505*	250	76.2	42.5	19.3	Matte Black	14 (41x30) BC	.049	1.24	.089	2.26	.558	14.17

SV Rubber Jacket • Smooth Jacket • UL/CSA Listed

300V, 60°C • Cotton Serve Separator • Color Code: Black, White, Green													
	8453	100	30.5	4.9	2.2	Black	18 (41x34) TC	.018	.46	.036	.91	.256	6.50
		500	152.4	21.0	9.5								

SVT PVC Jacket • Serrated Jacket • UL/CSA Listed

300V, 60°C • Paper Tape Separator • Color Code: Black, White, Green													
	19350	250 [†]	76.2	10.8	4.9	Gray	18 (42x34) BC	.018	.46	.038	.97	.253	6.43

SVT PVC Jacket • Smooth Jacket • UL/CSA Listed

300V, 60°C • Paper Tape Separator • International Color Code: Light Blue, Brown, Green/Yellow													
	19402	250 [†]	76.2	12.3	5.6	Black	18 (42x34) BC	.018	.46	.034	.86	.253	6.43

BC = Bare Copper

*These constructions are approved as water-resistant, oil-resistant and for outdoor use.

[†]Put-ups may contain more than one piece. Minimum length of any one piece is 50 ft.

3-, 4- and 5-Conductor

UL/CSA Type: SVT, SO

UL AWM Styles: 4097 and 4256

Description	Part No.	Standard Lengths		Standard Unit Weight		Jacket Color	Conductor AWG (stranding)	Nom. Insulation Thickness		Nom. Jacket Thickness		Nominal OD	
		Ft.	m	Lbs.	kg			Inch	mm	Inch	mm	Inch	mm

3-Conductor SVT PVC Jacket • Shielded • Smooth Jacket • 22 AWG Drain Wire (7x30) • UL/CSA Listed

300V, 60°C Shielded • Beldfoil® Shield (100% Coverage) • International Color Code: Light Blue, Brown, Green/Yellow



19401	250 [†]	76.2	12.3	5.6	Black	18 (42x34) BC	.018	.46	.043	1.09	.270	6.86
	1000 ^{††}	304.8	49.0	22.3								

300V, 60°C Shielded • Duofoil® Shield (100% Coverage) • Braid (88% Coverage) • Internat'l Color Code: Light Blue, Brown, Green/Yellow



19403	250 [†]	76.2	17.8	8.1	Black	18 (42x34) BC	.018	.46	.038	.97	.307	7.80
-------	------------------	------	------	-----	-------	---------------------	------	-----	------	-----	------	------

4-Conductor Rubber Jacket • Smooth Jacket • Style 4097

300V, 60°C • Paper Tape Separator • Color Code: Black, White, Brown, Red



8454*	100	30.5	5.8	2.6	Black	18 (41x34) TC	.018	.46	.036	.91	.265	6.73
	U-500	U-152.4	27.0	12.3								
	500	152.4	25.0	11.3								
	U-1000	U-304.8	52.0	23.6								
	1000	304.8	54.0	24.5								

4-Conductor SO Oil-Resistant Rubber Jacket • Smooth Jacket • UL/CSA Listed

600V, 90°C • Paper Tape Separator • Color Code: Black, White, Green, Red



19217	50	15.2	10.1	4.6	Black	14 (41x30) BC	.048	1.22	.087	2.21	.603	15.32
	200	60.9	43.6	19.8								
19216	50	15.2	17.2	7.8	Black	12 (65x30) BC	.051	1.30	.102	2.59	.690	17.53
	200	60.9	61.8	28.1								

5-Conductor Rubber Jacket • Smooth Jacket • Style 4256

300V, 60°C • Paper Tape Separator • Color Code: Brown, Green, White, Black, Red

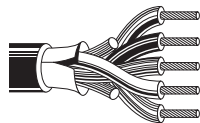

8455*	250	76.2	12.0	5.4	Black	3-20 (26x34) TC	.018	.46	.031	.79	.280	7.11
	U-500	U-152.4	25.5	11.6								
	U-1000	U-304.8	50.0	22.7								
						2-18 (41x34) TC						

BC = Bare Copper • TC = Tinned Copper

*Not CSA recognized.

[†]Put-ups may contain more than one piece. Minimum length of any one piece is 50 ft.

^{††}1000 ft. put-up one piece exact.

Multi-Conductor

Power and Control Cables

Description	Part No.	No. of Cond.	Standard Lengths		Standard Unit Weight		Jacket Color	Conductor AWG (stranding)	Nom. Insulation Thickness		Nom. Jacket Thickness		Nominal OD	
			Ft.	m	Lbs.	kg			Inch	mm	Inch	mm	Inch	mm

SO Oil-Resistant Rubber Jacket • Smooth Jacket • UL/CSA Listed

600V, 60°C • Conductors Cabled with Fillers • Paper Tape Separator • Color Code: See Chart 2 (Tech Info Section)

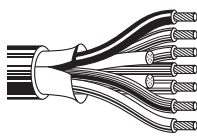
	9420	5	100	30.5	13.3	6.0	Black	16 (65x34) BC	.033	.84	.084	2.13	.506	12.85
			500	152.4	73.5	33.4								
			1000	304.8	143.0	65.0								
	9422	7	100	30.5	18.5	8.4	Black	16 (65x34) BC	.033	.84	.083	2.11	.581	14.76
			500	152.4	101.0	45.9								
			1000	304.8	201.0	91.4								
	9424	9	100	30.5	29.6	13.4	Black	16 (65x34) BC	.033	.84	.100	2.54	.720*	18.29
			500	152.4	150.5	68.4								
			1000	304.8	288.0	130.9								
9425	12	100	30.5	32.6	14.8	Black	16 (65x34) BC	.033	.84	.100	2.54	.720	18.29	
		500	152.4	165.5	75.2									
		1000	304.8	318.0	144.5									
9427	16	100	30.5	39.5	17.9	Black	16 (65x34) BC	.033	.84	.100	2.54	.787	19.99	
		500	152.4	194.5	89.0									
		1000	304.8	389.0	178.0									
9429	20	100	30.5	48.4	22.0	Black	16 (65x34) BC	.033	.84	.100	2.54	.862	21.89	
		500	152.4	233.0	105.9									
		1000	304.8	466.0	211.8									

BC = Bare Copper • CPE = Chlorinated Polyethylene
 *Fillers added in the center.

UL Cordage Type Designation

UL Cord Type	Description
HPN	Heater Parallel Neoprene
HSJ	Heater Service Junior
HSJO	HSJ with Oil-Resistant Jacket
S	Service
SE	Service Elastomer
SEO	SE with Oil-Resistant Jacket
SE00	SEO with Oil-Resistant Insulation
SJ	Service Junior
SJE	Service Junior Elastomer
SJEO	SJE with Oil-Resistant Jacket
SJEO0	SJEO with Oil-Resistant Insulation
SJO	SJ with Oil-Resistant Jacket
SJ00	SJO with Oil-Resistant Insulation
SJT	Service Junior Thermoplastic
SJTO	SJT with Oil-Resistant Jacket
SJTO0	SJTO with Oil-Resistant Insulation
SO	Service with Oil-Resistant Jacket
SO0	SO with Oil-Resistant Insulation
SP-1	Service Parallel — 1/32" Insulation
SP-2	Service Parallel — 3/64" Insulation
SP-3	Service Parallel — 1/16" Insulation
SPE-1	Service Parallel Elastomer — 1/32" Insulation
SPE-2	Service Parallel Elastomer — 3/64" Insulation
SPE-3	Service Parallel Elastomer — 1/16" Insulation
SPT-1	Service Parallel Thermoplastic — 1/32" Insulation
SPT-2	Service Parallel Thermoplastic — 3/64" Insulation
SPT-3	Service Parallel Thermoplastic — 1/16" Insulation
ST	Service Thermoplastic
STO	ST with Oil-Resistant Jacket
ST00	STO with Oil-Resistant Insulation
SV	Service Vacuum
SVE	Service Vacuum Elastomer
SVEO	SVE with Oil-Resistant Jacket
SVE00	SVEO with Oil-Resistant Insulation
SVO	SV with Oil-Resistant Jacket
SVO0	SVO with Oil-Resistant Insulation
SVT	Service Vacuum Thermoplastic
SVTO	SVT with Oil-Resistant Jacket
SVTO0	SVTO with Oil-Resistant Insulation
TPT	Tinsel Parallel Thermoplastic
TST	Tinsel Service Thermoplastic
XTW	Decorative Lighting Thermoplastic Parallel

NOTE: Service parallel types—wall thickness for integral construction.

Elastomer is a thermoplastic material with elastomeric properties similar to rubber.

UL Cordage Type

Construction and Rating

Cord Type*	AWG Size Range	No. of Cond.	Conductor Insulation Material and Min. Average Thickness (inches)	Jacket Material and Min. Average Thickness** (inches)	Temperature Rating (°C)†		Voltage Rating
					Standard	Other	
HPN	18 – 12	2 or 3††	.045 Rubber		90	105	300
HSJ	18 – 12	2, 3, 4	.030 Rubber††	.030 Rubber	90		300
HSJO	18 – 12	2, 3, 4	.030 Rubber▲	.030 Oil-Resistant Rubber	90		300
S	18 – 2	2 or more	.030 Rubber▲	.060 Rubber▲	60	75, 90	600
SE	18 – 2	2 or more	.030 Elastomer	.060 Elastomer	105		600
SEO	18 – 2	2 or more	.030 Elastomer	.060 Elastomer	105		600
SJ	18 – 10	2, 3, 4, 5	.030 Rubber♦	.030 Rubber	60	75, 90	300
SJE	18 – 10	2, 3, 4, 5	.030 Elastomer††	.030 Elastomer	105		300
SJEO	18 – 10	2, 3, 4, 5	.030 Elastomer	.030 Elastomer	105		300
SJO	18 – 10	2, 3, 4, 5	.030 Rubber♦	.030 Oil-Resistant Rubber	60	75, 90, 105	300
SJT	18 – 10	2, 3, 4, 5	.030 Plastic♦	.030 Plastic	60	75, 90, 105	300
SJTO	18 – 10	2, 3, 4, 5	.030 Plastic♦	.030 Plastic	60	75, 90, 105	300
SO	18 – 2	2 or more	.030 Rubber▲	.060 Oil-Resistant Rubber▲	60	75, 90	600
SP-1	18	2 or 3††	.030 Rubber		60		300
SP-2	18 – 16	2 or 3††	.045 Rubber		60		300
SP-3	18 – 12	2 or 3††	.060 Rubber▲		60		300
SPT-1	18	2 or 3††	.030 Plastic		60	75, 90, 105	300
SPT-2	18 – 16	2 or 3††	.045 Plastic		60	75, 90, 105	300
SPT-3	18 – 10	2 or 3††	.060 Plastic▲		60	75, 90, 105	300
ST	18 – 2	2 or more	.030 Plastic▲	.060 Plastic▲	60	75, 90, 105	600
STO	18 – 2	2 or more	.030 Plastic▲	.060 Plastic▲	60	75, 90, 105	600
SV	18	2 or 3††	.015 Rubber	.030 Rubber	60	75, 90	300
SVE	18 – 17	2 or 3††	.015 Elastomer	.030 Elastomer	105		300
SVEO	18 – 17	2 or 3††	.015 Elastomer	.030 Elastomer	105		300
SVO	18	2 or 3††	.015 Rubber	.030 Oil-Resistant Rubber	60	75, 90	300
SVT	18 – 17	2 or 3††	.015 Plastic	.030 Plastic	60	75, 90, 105	300
SVTO	18 – 17	2 or 3††	.015 Plastic	.030 Plastic	60	75, 90, 105	300
TPT	27 (Tinsel)	2	.030 Plastic		60		300
TST	27 (Tinsel)	2	.015 Plastic	.030 Rubber	60		300

* Types SVO, SVTO, SJO, SJTO, SO, STO and HSJO have jackets which are also recognized for oil resistance at maximum temperature of 60°C. Types SJ, SJO, SJT, SJTO, S, SO, ST and STO may also be made for outdoor use and will be indicated by adding a "W" suffix to the cord type. Similarly, types SJ, SJTO, SJO, SJT, S, SO, ST and STO may also be made in water-resistant grades with "Water-Resistant" printed on the jacket. 3-wire SJT may be made in special low-leakage constructions for medical equipment cords.

** Where no jacket is shown, the construction is integral or flat style with insulation also serving as jacket.

† For cordage ratings higher than 60°C, the temperature limit is printed on the outside of the jacket. This does not apply to heater cordage type HPN, rated 90°C, or 105°C.

†† Recognized in three conductors when third or center conductor (with Green or Green/Yellow stripe) is used for equipment grounding.

▲ Insulation and jacket thickness depend on cordage size. Thickness as shown are for 18 and 16 AWG.

♦ Insulation and jacket thickness depend on cordage size.
No. 12 AWG requires .030" conductor insulation thickness and .045" jacket thickness.
No. 10 AWG requires .045" conductor insulation thickness and .060" jacket thickness.

The term Elastomer refers to thermoplastic elastomer.



Optical Fiber

10



Table of Contents

Optical Fiber Cables	Page No.
Cable Selection Guide	10.2
Optical Fiber Selection	10.2
Optical Specifications	10.2
Color Codes	10.2
Interconnect Cable — Simplex & Duplex	10.3
Tight Buffer — Riser & Plenum	
Distribution Cable	10.4–10.5
Tight Buffer — Indoor Riser, Plenum & LSZH	
Breakout Style Cable	10.6–10.7
Tight Buffer — Indoor Riser, Plenum & LSZH	
Industrial Armored Cable	10.8
Tight Buffer — Riser & Plenum	
Tactical Cable	10.9
Tight Buffer — Outdoor	
Ribbon Cable	10.10
Riser & Plenum	
Single Jacket, All Dielectric Cable	10.11–10.12
Loose Tube — Outdoor & Indoor/Outdoor Riser	10.11
Loose Tube — Indoor/Outdoor Plenum	10.12
Double Jacket, Armored Cable	10.13
Loose Tube — Outdoor & Indoor/Outdoor Riser	
Double Jacket, Heavy-Duty Cable	10.14
Loose Tube — Outdoor	
Central Tube Cable	10.15
Loose Tube — Outdoor & Outdoor Armored	
Micro Loose Tube Breakout Style Cable	10.16–10.17
Loose Tube — Outdoor, Indoor/Outdoor OFN & Indoor/Outdoor Riser	
TrayOptic® Heavy-Duty, All Dielectric Cable	10.18
Loose Tube — Indoor/Outdoor Riser	

Cable Selection Guide

Introduction

The Belden line of Optical Fiber Cables represents a new selection of the best optical fiber cable products offered by the consolidated resources of the Belden organization. The unmatched resources of Belden have now generated a complete line of indoor and outdoor cable products in tight buffered and loose tube constructions. This offering now expands the available applications for Belden optical fiber cable.

Customer Service

Most of our optical fiber cables are available from stock. Many of these are available off-the-shelf from distributors. If you have a new or unusual application, or you cannot find a optical fiber cable in this catalog section that meets your technical requirements, contact Technical Support at 1-800-BELDEN-1 for additional information.

Cable Selection Guide

Optical Fiber

Fiber Selection Chart

Type	Grade	Fiber Size (μ)	Standards Compliance	Link Length (m)	Data Rate (Gb)
Multimode	6	50/125	exceeds TIA/EIA-568-B.3-1 ISO 11801 OM3	500	10
	5	50/125	TIA/EIA-568-B.3-1 ISO 11801 OM3	300	10
	4	50/125	TIA/EIA-568-B.3	600	1
	3	62.5/125	TIA/EIA-568-B.3	1,000	1
	2	62.5/125	TIA/EIA-568-B.3	550	1
	1 [▲]	62.5/125	FDDI grade [†]	—	—
Single-mode	—	—	ITU G.652.c/d ^{††}	—	—

[▲] Grade 1 fibers are available upon request.

[†] Used in most current cable plants, but not recommended for future installations, except as patch cordage

^{††} Low water peak fiber with advantages for CWDM applications

Color Code Charts

Jacket Color Chart

Cable Type	Jacket Color
Loose Tube & Outside Plant Cables	Black
Industrial Tray Cables	Orange
Tight Buffered Cables	
Grades 2,3,4	Orange
Grades 5,6	Aqua
Single-mode	Yellow

Nonstandard jacket colors are available upon request.

Fiber Sub-unit Color Code Chart*

Fiber/Tube No.	Color	Fiber/Tube No.	Color
1	Blue	7	Red
2	Orange	8	Black
3	Green	9	Yellow
4	Brown	10	Violet
5	Slate	11	Rose
6	White	12	Aqua

*Per EIA/TIA 598-A

Optical Specifications

Grade:	2	3	4	5	6	Single-mode Enhanced [§]
Glass Type:	62.5/125μ	62.5/125μ	50/125μ	50/125μ	50/125μ	
Operating Wavelength (nm)	850/1300	850/1300	850/1300	850/1300	850/1300	1310/1550
Min. OFL ¹ Bandwidth (MHz-km)	200/500	200/500	500/500	1500/500	3000/500	—
Min. Laser ² Bandwidth (MHz-km)	220/500	385/500	510/500	2000/500	4000/500	—
Max. Attenuation Loose Tube (dB/km)	3.25/1.0	3.25/1.0	3.0/1.0	3.0/1.0	3.0/1.0	0.40/0.30
Max. Attenuation Tight Buffered ³ (dB/km)	3.50/1.25	3.50/1.25	3.50/1.25	3.50/1.25	3.50/1.25	0.80/0.50
100 Mb Fast Ethernet Min. Link Length (meters S/L ⁴)	300/2000	300/2000	300/2000	300/2000	300/2000	—/5000
1 Gb Ethernet Min. Link Length (meters S/L ⁴)	300/550	500/1000	600/600	1000 ⁵ /600	1000 ⁵ /600	—/5000
10 Gb Ethernet Min. Link Length (meters S/L ⁴)	35/300	35/300	85/300	300/300	500/300	—/10,000

¹ OFL = Overfilled Launch

² Effective Modal Bandwidth, determined by RML or DMD performance specifications

³ Max. Attenuation for Tight Buffered, Ribbon, Micro-Loose Tube and Loose Tube Plenum Cables

⁴ S/L = Short wavelength (850 nm) / Long wavelength (1310 nm)

⁵ >2000 meters for engineered links

⁶ Low water peak Single-Mode suitable for CWDM use complies with ITU G.652.c/d

Interconnect Cable — Simplex and Duplex

Tight Buffer — Riser & Plenum Rated

Applications

- Patch panels
- Workstation equipment connections
- Horizontal distribution in open office environments

Product Description

Interconnect Cables are designed for low fiber-count premises environments. They are small and very flexible, making them ideal for confined spaces. Their aesthetic appearance makes these cables suitable for use in open office environments. Available in 1 or 2 fibers. One sub-unit is marked to permit easy identification of transmit and receive fibers. Length markings to facilitate installation.

Jacket Material	PVC
Tight Buffer	PVC
Strength Member	Aramid Yarn
Color Code (Tight Buffer)	Per EIA/TIA 598-A, see page 10.2
Jacket Color	
Single-mode	Yellow
62.5/125 μm	Orange
50/125 μm / 1 Gbe	Orange
50/125 μm / 10 Gbe	Aqua

Ratings

Riser	
UL Type	OFNR
cUL Type	OFN FT4
Flame Resistance	UL 1666
Plenum	
UL Type	OFNP
cUL Type	OFN FT6
Flame Resistance	NFPA 262

Specifications

Temperature Range	
Storage	-40 to +70°C
Operating	-20 to +70°C
Crush Resistance (EIA-455-41)	200 N/cm
Impact Resistance (EIA-455-25)	20 Impacts @ 1.0 N-m
Cyclic Flexing (EIA-455-104)	2000 cycles, min.
Min. Bend Radius	
Installation	15 x OD
Long Term	10 x OD
Optical Specifications	See page 10.2

Fiber Bundle Detail

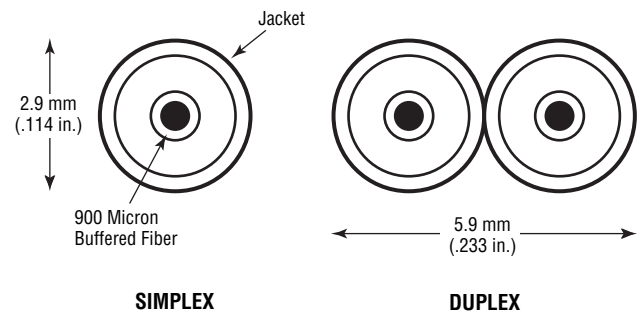

No. of Fibers	Belden Part Number				Outside Diameter		Weight		Max. Install Load	
	62.5 / 125μm Std. / 1 Gbe	50 / 125μm Std. / 1 Gbe	50 / 125μm 10 Gbe – 300M	Single-mode Enhanced	Inch	mm	Lbs./1000'	kg/km	Lbs.	N
Interconnect Cable Series										
Riser (NEC/CEC OFNR/OFN FT4)										
1	M97112	M9A001	M9C001	M9W001	0.114	2.9	6	9	90	400
2	M96915	M9A002	M9C002	M9W002	0.11 x 0.23	2.9 x 5.9	12	18	180	801
Plenum (NEC/CEC OFNP/OFN FT6)										
1	M98086	M9A003	M9C003	M9W003	0.114	2.9	6	9	90	400
2	M96919	M9A004	M9C004	M9W004	0.11 x 0.23	2.9 x 5.9	13	19	180	801

All optical fiber products can be supplied in compliance with RoHS regulations. Please contact Customer Service for more details.

Distribution Cable

Tight Buffer — Indoor Riser, Plenum & LSZH Rated

Applications

- Low to high fiber count requirements
- In-building backbone
- Fiber-to-the-desk applications
- Computer room

Product Description

Flexible thermoplastic jacket provides excellent handling characteristics. Fibers and cable sub-units are color coded for easy identification. Length markings in meters for easy determination of cable length. Full dielectric construction, no grounding required. For Riser offering, MSHA approved cables are available.

Jacket Material

Riser & Non-unitized Plenum	PVC
Unitized Plenum	PVDF
Low Smoke Zero Halogen	LSZH

Tight Buffer

Riser & Plenum	PVC
Low Smoke Zero Halogen	LSZH

Strength Member

Aramid Yarn

Color Code (Tight Buffer)

Per EIA/TIA 598-A, see page 10.2

Jacket Color

Single-mode	Yellow
62.5/125 μm	Orange (Green for LSZH only)
50/125 μm / 1 Gbe	Orange
50/125 μm / 10 Gbe	Aqua

Ratings

Riser

UL Type	OFNR
cUL Type	OFN FT4
Flame Resistance	UL 1666

Plenum

UL Type	OFNP
cUL Type	OFN FT6
Flame Resistance	NFPA 262

Low Smoke Zero Halogen

UL Type	OFNR
cUL Type	OFN FT4
Flame Resistance	UL 1666

Specifications

Temperature Range

Storage	-40 to +80°C
Operating	-20 to +70°C

Crush Resistance (EIA-455-41) 2000 N/cm

Impact Resistance (EIA-455-25) 2000 Impacts @ 1.6 N-m

Cyclic Flexing (EIA-455-104) 2000 cycles, min.

Min. Bend Radius

Installation	15 x OD
Long Term	10 x OD

Optical Specifications See page 10.2

Fiber Bundle Detail

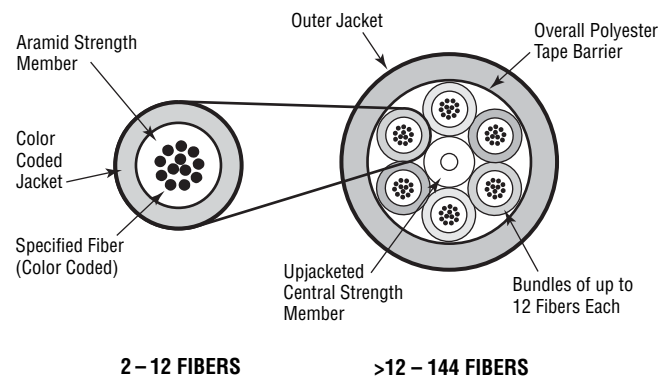

2 – 12 FIBERS

>12 – 144 FIBERS

Distribution Cable

Tight Buffer — Indoor Riser, Plenum & LSZH Rated (*continued*)

No. of Fibers	Belden Part Number				Outside Diameter		Weight		Max. Install Load	
	62.5 / 125µm Std. / 1 Gbe	50 / 125µm Std. / 1 Gbe	50 / 125µm 10 Gbe – 300M	Single-mode Enhanced	Inch	mm	Lbs./1000'	kg/km	Lbs.	N
Distribution Cable Series										
Riser (NEC/CEC OFNR/OFN FT4)										
2	M9B037	M9A037	M9C037	M9W037	0.184	4.67	13	19	180	801
4	M9B038	M9A038	M9C038	M9W038	0.200	5.08	16	24	195	867
6	M9B039	M9A039	M9C039	M9W039	0.220	5.59	19	28	270	1201
8	M9B040	M9A040	M9C040	M9W040	0.235	5.97	22	33	270	1201
12	M9B042	M9A042	M9C042	M9W042	0.255	6.48	27	40	300	1334
24	M9B601*	M9A601*	M9C601*	M9W601*	0.325	8.26	42	63	390	1735
24	M9B602	M9A602	M9C602	M9W602	0.496	12.60	83	124	960	4270
36	M9B604	M9A604	M9C604	M9W604	0.644	16.36	137	204	1440	6405
48	M9B606	M9A606	M9C606	M9W606	0.627	15.93	131	195	945	4203
72	M9B609	M9A609	M9C609	M9W609	0.750	19.10	195	290	1350	6005
96	M9B622	M9A622	M9C622	M9W622	0.895	22.70	290	432	1983	8820
144	M9B619	M9A619	M9C619	M9W619	0.964	24.49	314	467	2745	12210
Composite Riser Cables										
6xSM/12x62.5	M96992									
12xSM/12x62.5	M96963									
6xSM/12x50	M96909									
12xSM/12x50	M96908									
Plenum (NEC/CEC OFNP/OFN FT6)										
2	M9B043	M9A043	M9C043	M9W043	0.184	4.67	14	21	180	801
4	M9B044	M9A044	M9C044	M9W044	0.174	4.42	13	19	195	867
6	M9B045	M9A045	M9C045	M9W045	0.190	4.83	16	24	270	1201
8	M9B046	M9A046	M9C046	M9W046	0.222	5.64	19	28	270	1201
12	M9B048	M9A048	M9C048	M9W048	0.225	5.72	22	33	300	1334
24	M9B611*	M9A611*	M9C611*	M9W611*	0.330	8.38	40	60	390	1735
24	M9B612	M9A612	M9C612	M9W612	0.493	12.52	89	132	1263	5618
36	M9B614	M9A614	M9C614	M9W614	0.594	15.09	134	199	1913	8509
48	M9B616	M9A616	M9C616	M9W616	0.599	15.21	131	195	1245	5538
72	M9B620	M9A620	M9C620	M9W620	0.754	19.15	197	293	2093	9310
96	M9B623	M9A623	M9C623	M9W623	0.904	22.96	268	399	2160	9608
144	M9B621	M9A621	M9C621	M9W621	1.047	26.59	365	543	3645	16213
Composite Plenum Cables										
6xSM/6x62.5	M97174									
6xSM/12x62.5	M97041									
12xSM/12x62.5	M97219									
6xSM/6x50	M97412									
6xSM/12x50	M97411									
12xSM/12x50	M96780									
LSZH (NEC/CEC OFNR/OFN FT4)										
2	M9B100	M9A100	M9C100	M9W100	0.184	4.70	15	22	180	800
4	M9B101	M9A101	M9C101	M9W101	0.200	5.10	17	25	195	867
6	M9B102	M9A102	M9C102	M9W102	0.220	5.60	21	31	270	1201
8	M9B103	M9A103	M9C103	M9W103	0.235	6.00	24	36	270	1201
12	M9B104	M9A104	M9C104	M9W104	0.255	6.50	29	43	300	1334
16	M9B105	M9A105	M9C105	M9W105	0.347	8.80	43	63	315	1400
24	M9B107	M9A107	M9C107	M9W107	0.386	9.80	54	79	450	2000
36	M9B111	M9A111	M9C111	M9W111	0.798	20.00	214	313	1619	7200
48	M9B112	M9A112	M9C112	M9W112	0.835	21.20	237	347	1619	7200
72	M9B114	M9A114	M9C114	M9W114	0.883	22.40	270	395	1619	7200
96	M9B116	M9A116	M9C116	M9W116	0.973	24.70	364	532	1619	7200
144	M9B120	M9A120	M9C120	M9W120	1.087	27.60	384	561	1619	7200

All optical fiber products can be supplied in compliance with RoHS regulations. Please contact Customer Service for more details. Construction for LSZH cables differs from the drawing. Alternative fiber counts are available.

*Single jacket design.

Breakout Style Cable

Tight Buffer — Indoor Riser, Plenum & LSZH Rated

Applications

- Low to medium fiber count requirements
- In-building backbone or horizontal deployment
- Office wiring
- Factory floor automation and harsh environment installations

Product Description

Full dielectric construction, no grounding required. Available with 2 to 36 fibers. Fiber subunits are color coded for easy identification. Length markings in meters for easy determination of cable length. For Riser offering, MSHA approved cables are available.

Outer Jacket Material

Riser & Plenum	PVC
Plenum	PVDF
Low Smoke Zero Halogen	LSZH

Sub-unit Jacket Material

Riser & Plenum	PVC
Low Smoke Zero Halogen	LSZH

Tight Buffer

Riser & Plenum	PVC
Low Smoke Zero Halogen	LSZH

Strength Member

Aramid Yarn

Color Code (Tight Buffer) Per EIA/TIA 598-A, see page 10.2

Jacket Color

Single-mode	Yellow
62.5/125 μm	Orange (Green for LSZH only)
50/125 μm / 1 Gbe	Orange
50/125 μm / 10 Gbe	Aqua

Ratings

Riser

UL Type	OFNR
cUL Type	OFN FT4
Flame Resistance	UL 1666

Plenum

UL Type	OFNP
cUL Type	OFN FT6
Flame Resistance	NFPA 262

Low Smoke Zero Halogen

UL Type	OFNR
cUL Type	OFN FT4
Flame Resistance	UL 1666

Specifications

Temperature Range

Storage	-40 to +80°C
Operating	-20 to +70°C

Crush Resistance (EIA-455-41) 2000 N/cm

Impact Resistance (EIA-455-25) 2000 Impacts @ 1.6 N-m

Cyclic Flexing (EIA-455-104) 2000 cycles, min.

Min. Bend Radius

Installation	15 x OD
Long Term	10 x OD

Optical Specifications See page 10.2

Fiber Bundle Detail

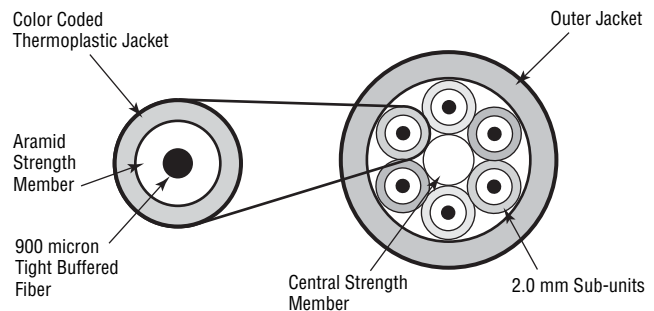

Breakout Style CableTight Buffer — Indoor Riser, Plenum & LSZH Rated (*continued*)

No. of Fibers	Belden Part Number				Outside Diameter		Weight		Max. Install Load	
	62.5 / 125µm Std. / 1 Gbe	50 / 125µm Std. / 1 Gbe	50 / 125µm 10 Gbe – 300M	Single-mode Enhanced	Inch	mm	Lbs./1000'	kg/km	Lbs.	N
Breakout Cable Series										
Riser (NEC/CEC OFNR/OFN FT4)										
2	M9B005	M9A005	M9C005	M9W005	0.260	6.60	24	36	180	801
4	M9B006	M9A006	M9C006	M9W006	0.321	8.15	35	52	345	1535
6	M9B007	M9A007	M9C007	M9W007	0.358	9.09	54	80	543	2415
8	M9B008	M9A008	M9C008	M9W008	0.405	10.29	69	103	600	2700
10	M9B009	M9A009	M9C009	M9W009	0.455	11.56	86	128	600	2700
12	M9B010	M9A010	M9C010	M9W010	0.514	13.06	110	164	600	2700
18	M9B011	M9A011	M9C011	M9W011	0.520	13.21	104	155	600	2700
24	M9B012	M9A012	M9C012	M9W012	0.590	14.99	135	201	600	2700
36	M9B083	M9A083	M9C083	M9W083	0.680	17.27	168	250	600	2700
Plenum (NEC/CEC OFNP/OFN FT6)										
2	M9B013	M9A013	M9C013	M9W013	0.230	5.84	20	30	180	801
4	M9B014	M9A014	M9C014	M9W014	0.263	6.68	30	45	345	1535
6	M9B015	M9A015	M9C015	M9W015	0.309	7.85	41	61	465	2068
8	M9B016	M9A016	M9C016	M9W016	0.336	8.53	55	82	600	2700
10	M9B017	M9A017	M9C017	M9W017	0.385	9.78	73	109	600	2700
12	M9B018	M9A018	M9C018	M9W018	0.391	9.93	65	97	600	2700
18	M9B019	M9A019	M9C019	M9W019	0.456	11.58	89	132	600	2700
24	M9B020	M9A020	M9C020	M9W020	0.544	13.82	117	174	600	2700
36	M9B082	M9A082	M9C082	M9W082	0.612	15.54	154	229	600	2700
LSZH (NEC/CEC OFNR/OFN FT4)										
2	M9B130	M9A130	M9C130	M9W130	0.290	7.37	39	57	270	1200
4	M9B131	M9A131	M9C131	M9W131	0.351	8.92	38	55	285	1268
6	M9B132	M9A132	M9C132	M9W132	0.358	9.09	52	76	543	2415
8	M9B133	M9A133	M9C133	M9W133	0.405	10.29	67	98	600	2700
10	M9B134	M9A134	M9C134	M9W134	0.455	11.56	110	162	600	2700
12	M9B135	M9A135	M9C135	M9W135	0.514	13.06	110	161	600	2700
18	M9B136	M9A136	M9C136	M9W136	0.520	13.21	103	151	600	2700
24	M9B137	M9A137	M9C137	M9W137	0.590	14.99	138	202	600	2700
36	M9B138	M9A138	M9C138	M9W138	0.680	17.27	171	250	600	2700

All optical fiber products can be supplied in compliance with RoHS regulations. Please contact Customer Service for more details.
2.5 mm Breakout Cables are also available.

Industrial Armored Cable

Tight Buffer — Riser & Plenum Rated

Applications

- Industrial environments
- Rugged installations
- Manufacturing plants
- Mining operations
- Telecommunications and data trunk
- Inter- and intra-building installations

Product Description

Heavy duty construction with interlocking aluminum armor (steel available on request) provides excellent mechanical protection from cutting or crushing and eliminates need for innerduct. Rodent resistant. Also available for outside plant. Loose tube design available on request.

Jacket Material	Riser & Plenum	PVC
Buffer Tube		PVC
Strength Member		Aramid Yarn
Central Strength Member		E-Glass
Armor		Aluminum
Color Code (Buffer)		Per EIA/TIA 598-A, see page 10.2
Jacket Color	Single-mode 62.5/125 μm 50/125 μm / 1 Gbe 50/125 μm / 10 Gbe	Yellow Orange Orange Aqua

Ratings

Riser	UL Type	OFCR
	cUL Type	OFC FT4
	Flame Resistance	UL 1666
Plenum	UL Type	OFCP
	cUL Type	OFC FT6
	Flame Resistance	NFPA 262

Specifications

Temperature Range	Storage	-40 to +70°C
	Operating	-20 to +70°C
Crush Resistance (EIA-455-41)		2000 N/cm
Impact Resistance (EIA-455-25)		2000 Impacts @ 3.0 N-m
Min. Bend Radius	Installation	20 x OD
	Long Term	15 x OD
Optical Specifications		See page 10.2

Fiber Bundle Detail

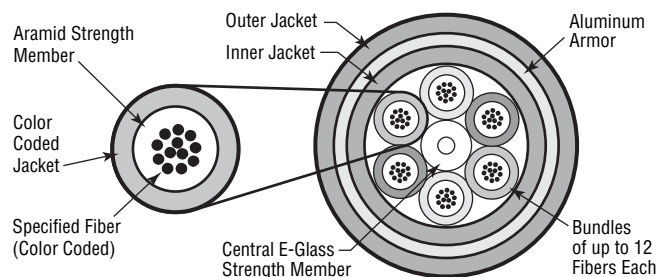

No. of Fibers	Belden Part Number				Outside Diameter		Weight		Max. Install Load	
	62.5 / 125μm Std. / 1 Gbe	50 / 125μm Std. / 1 Gbe	50 / 125μm 10 Gbe – 300M	Single-mode Enhanced	Inch	mm	Lbs./'1000'	kg/km	Lbs.	N

Industrial Armored Series

Riser (NEC/CEC OFCR/OFC FT4)										
6	M9B230	M9A230	M9C230	M9W230	0.570	14.50	126	188	270	1201
12	M9B231	M9A231	M9C231	M9W231	0.620	15.70	149	222	300	1334
24	M9B232*	M9A232*	M9C232*	M9W232*	0.670	17.00	179	266	390	1735
24	M9B233	M9A233	M9C233	M9W233	0.845	21.46	263	391	600	2700
36	M9B234	M9A234	M9C234	M9W234	0.970	24.64	368	548	600	2700
48	M9B235	M9A235	M9C235	M9W235	0.970	24.64	368	548	600	2700
72	M9B236	M9A236	M9C236	M9W236	1.095	27.82	481	716	600	2700
96	M9B237	M9A237	M9C237	M9W237	1.245	31.62	625	930	600	2700
144	M9B238	M9A238	M9C238	M9W238	1.320	33.55	675	1005	600	2700
Plenum (NEC/CEC OFCP/OFC FT6)										
6	M9B240	M9A240	M9C240	M9W240	0.471	12.00	87	129	270	1201
12	M9B241	M9A241	M9C241	M9W241	0.506	12.90	103	153	300	1334
24	M9B242*	M9A242*	M9C242*	M9W242*	0.631	16.00	151	225	390	1735
24	M9B243	M9A243	M9C243	M9W243	0.781	19.84	289	430	600	2700
36	M9B244	M9A244	M9C244	M9W244	0.881	22.38	309	460	600	2700
48	M9B245	M9A245	M9C245	M9W245	0.906	23.01	320	476	600	2700
72	M9B246	M9A246	M9C246	M9W246	1.056	26.82	451	671	600	2700
96	M9B247	M9A247	M9C247	M9W247	1.256	31.90	608	905	600	2700
144	M9B248	M9A248	M9C248	M9W248	1.331	33.81	687	1022	600	2700

Additional optical fiber cable constructions are available upon request. All optical fiber products can be supplied in compliance with RoHS regulations. Please contact Customer Service for more details.
*Single jacket design.



Tactical Cable

Tight Buffer — Outdoor

Applications

- ENG vehicles
- Outdoor news, sporting or other events
- Digital camera transmission
- Military communications
- Re-deployable communications

Product Description

Small and lightweight with a rugged jacket, Tactical Cable provides a durable design for repeated deployment and retrieval cycles and a superior level of crush resistance. Designed to military standards. 50/125 micron fiber available on request.

Jacket Material	UV-resistant PU
Buffer	Polyester
Strength Member	Aramid Yarn
Color Code (Jacket & Fibers)	Per EIA/TIA 598-A, see page 10.2

Specifications

Temperature Range	
Storage	-70 to +85°C
Operating	-55 to +85°C
Crush Resistance (EIA-455-41)	440 N/cm
Impact Resistance (EIA-455-25)	200 Impacts @ 2.2 N-m
Cyclic Flexing (EIA-455-104)	2000 cycles, min.
Min. Bend Radius	
Installation	15 x OD
Long Term	8 x OD
Optical Specifications	See page 10.2

Fiber Bundle Detail

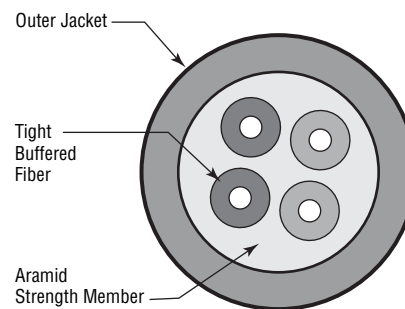

No. of Fibers	Belden Part Number		Outside Diameter		Weight		Max. Install Load	
	62.5 / 125µm Std. / 1 Gbe	Single-mode Enhanced	Inch	mm	Lbs./1000'	kg/km	Lbs.	N

Tactical Series

Outdoor								
2	M96571	M96566	0.217	5.5	19	28	330	1468
4	M96551	M96639	0.225	5.7	21	31	330	1468
6	M96572	M96567	0.236	6.0	23	34	330	1468
8	M96573	M96568	0.250	6.3	26	39	330	1468
10	M96574	M96569	0.265	6.7	28	42	330	1468
12	M96575	M96570	0.280	7.1	31	46	330	1468

Please contact the Technical Support Group for proper connectivity integration and installation guidance. All optical fiber products can be supplied in compliance with RoHS regulations. Please contact Customer Service for more details.

Ribbon Cable

Riser and Plenum Rated

Applications

- Inter-equipment connections
- NEBS applications

Product Description

Small size is ideal for connections in tight spaces. Color coded fibers. Suitable for use with standard ribbon connectors. Flexible, with half-inch minimum bend radius. Tight center-to-center tolerances. Optional identification printing available.

Jacket Material	PVC
Strength Member	Aramid Yarn
Color Code (Jacket & Fibers)	Per EIA/TIA 598-A, see page 10.2
Jacket Color	
Single-mode	Yellow
62.5/125µm	Orange
50/125 µm / 1 Gbe	Orange
50/125 µm / 10 Gbe	Aqua

Ratings

Riser	
UL Type	OFNR
cUL Type	OFN FT4
Flame Resistance	UL 1666
Plenum	
UL Type	OFNP
cUL Type	OFN FT6
Flame Resistance	NFPA 262

Specifications

Temperature Range	
Storage	-40 to +80°C
Operating	-20 to +70°C
Crush Resistance (EIA-455-41)	2000 N/cm
Impact Resistance (EIA-455-25)	2000 Impacts @ 1.6 N-m
Cyclic Flexing (EIA-455-104)	2000 cycles, min.
Min. Bend Radius	
Installation	15 x OD
Long Term	10 x OD
Optical Specifications	See page 10.2

Fiber Bundle Detail

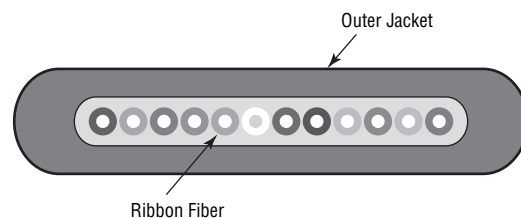

No. of Fibers	Belden Part Number				Outside Diameter		Weight		Max. Install Load	
	62.5 / 125µm Std. / 1 Gbe	50 / 125µm Std. / 1 Gbe	50 / 125µm 10 Gbe – 300M	Single-mode Enhanced	Inch	mm	Lbs./1000'	kg/km	Lbs.	N

Ribbon Series

Riser (NEC/CEC OFNR/OFN FT4)										
2	M9B630	M9A630	M9C630	M9W630	0.114	2.9	5	7	100	444
4	M9B631	M9A631	M9C631	M9W631	0.78 x 0.115	2.0 x 2.9	4	6	100	444
6	M9B632	M9A632	M9C632	M9W632	0.78 x 0.137	2.0 x 3.5	6	9	100	444
8	M9B633	M9A633	M9C633	M9W633	0.78 x 0.158	2.0 x 4.0	6	9	100	444
12	M9B634	M9A634	M9C634	M9W634	0.78 x 0.180	2.0 x 4.6	7	10	100	444
Plenum (NEC/CEC OFNP/OFN FT6)										
2	M9B640	M9A640	M9C640	M9W640	0.114	2.9	5	7	100	444
4	M9B641	M9A641	M9C641	M9W641	0.78 x 0.115	2.0 x 2.9	4	6	100	444
6	M9B642	M9A642	M9C642	M9W642	0.78 x 0.137	2.0 x 3.5	6	9	100	444
8	M9B643	M9A643	M9C643	M9W643	0.78 x 0.158	2.0 x 4.0	6	9	100	444
12	M9B644	M9A644	M9C644	M9W644	0.78 x 0.180	2.0 x 4.6	7	10	100	444

Fiber Ribbon Cable is to be sold as bulk cable and has not been qualified for field connectorization. All optical fiber products can be supplied in compliance with RoHS regulations. Please contact Customer Service for more details.

Single Jacket, All Dielectric Cable

Loose Tube — Outdoor, and Indoor/Outdoor Riser Rated

Applications

- Medium to high fiber count requirements
- Inter-building duct installations
- Lashed aerial
- Indoor/outdoor
- Industrial outside plant

Product Description

Gel-filled buffer tube prevents water migration. All-dielectric strength member. Available as Riser rated cable, thereby eliminating the need for service entrance splicing to in-building cable. Full dielectric construction, no grounding required. Available with up to 216 fibers. Length markings in meters for easy determination of cable length.

Jacket Material	
Outdoor	PE
Riser	PVC
Buffer Tube	PBT
Strength Member	Aramid Yarn
Central Strength Member	E-Glass
Color Code (Buffer)	Per EIA/TIA 598-A, see page 10.2
Jacket Color	Black

Ratings

Riser	
UL Type	OFNR
cUL Type	OFN FT4
Flame Resistance	UL 1666

Specifications

Temperature Range (Outdoor Series)	
Storage	-50 to +80°C
Operating	-40 to +70°C
Temperature Range (Riser Series)	
Storage	-40 to +80°C
Operating	-40 to +70°C
Crush Resistance (EIA-455-41)	2000 N/cm
Impact Resistance (EIA-455-25)	2000 Impacts @ 1.6 N-m
Min. Bend Radius	
Installation	20 x OD
Long Term	15 x OD
Optical Specifications	See page 10.2

Fiber Bundle Detail

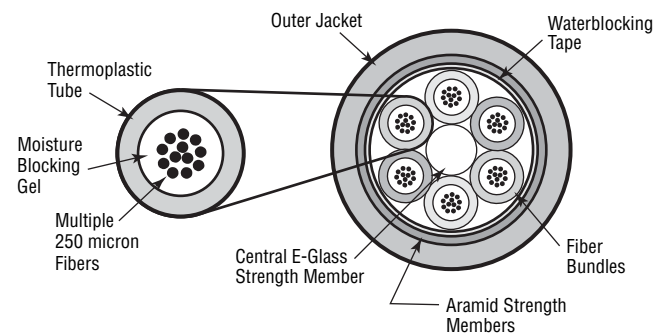

No. of Fibers	Fibers Per Tube	Belden Part Number				Outside Diameter		Weight		Max. Install Load	
		62.5 / 125µm Std. / 1 Gbe	50 / 125µm Std. / 1 Gbe	50 / 125µm 10 Gbe – 300M	Single-mode Enhanced	Inch	mm	Lbs./1000'	kg/km	Lbs.	N

Loose Tube Series

Outdoor											
6	6	M9B510T	M9A510T	M9C510T	M9W510T	0.38	9.65	44	65	600	2700
12	6	M9B511T	M9A511T	M9C511T	M9W511T	0.38	9.65	44	65	600	2700
24	6	M9B500T	M9A500T	M9C500T	M9W500T	0.38	9.65	45	67	600	2700
36	6	M9B502T	M9A502T	M9C502T	M9W502T	0.38	9.65	47	70	600	2700
48	12	M9B505T	M9A505T	M9C505T	M9W505T	0.48	12.19	70	104	600	2700
72	12	M9B507T	M9A507T	M9C507T	M9W507T	0.48	12.19	70	104	600	2700
96	12	M9B513T	M9A513T	M9C513T	M9W513T	0.55	13.89	93	138	600	2700
144	12	M9B509T	M9A509T	M9C509T	M9W509T	0.70	17.78	149	222	600	2700
216	12	M9B520T	M9A520T	M9C520T	M9W520T	0.72	18.16	148	220	600	2700
Riser (NEC/CEC OFNR/OFN FT4)											
6	6	M9B810	M9A810	M9C810	M9W810	0.38	9.65	63	94	600	2700
12	6	M9B811	M9A811	M9C811	M9W811	0.38	9.65	62	92	600	2700
24	6	M9B812	M9A812	M9C812	M9W812	0.38	9.65	61	91	600	2700
36	6	M9B813	M9A813	M9C813	M9W813	0.38	9.65	60	89	600	2700
48	12	M9B814	M9A814	M9C814	M9W814	0.48	12.20	89	132	600	2700
72	12	M9B815	M9A815	M9C815	M9W815	0.48	12.20	87	129	600	2700
96	12	M9B816	M9A816	M9C816	M9W816	0.55	13.89	114	170	600	2700
144	12	M9B817	M9A817	M9C817	M9W817	0.70	17.78	187	278	600	2700

Alternative fiber counts are available. All optical fiber products can be supplied in compliance with RoHS regulations. Please contact Customer Service for more details.



Single Jacket, All Dielectric Cable

Loose Tube — Indoor/Outdoor Plenum Rated

Applications

- Medium to high fiber count requirements
- Inter-building duct installations
- Lashed aerial
- Indoor/outdoor
- Campus backbones
- Data Centers
- High Density Cable Trays

Product Description

Dry waterblocking technology used within tubes and under jacket. Available as Plenum rated cable, thereby eliminating the need for service entrance splicing to in-building cable. Small diameter and bend radius facilitate installation in tight spaces. Full dielectric construction, no grounding required. Available with up to 144 fibers. Fibers grouped into sets of 12 for maximum density. Length markings in meters for easy determination of cable length.

Jacket Material	PVC Non-unitized PVDF Unitized
Buffer Tube	PVC
Strength Member	E-Glass and Aramid Yarn
Central Strength Member	Upjacketed
Color Code (Buffer)	Per EIA/TIA 598-A, see page 10.2
Jacket Color	Black

Ratings

Plenum	OFNP
UL Type	OFN FT6
cUL Type	NFPA 262
Flame Resistance	

Specifications

Temperature Range	
Storage	-40 to +80°C
Operating	-40 to +70°C
Installation	0 to +60°C
Crush Resistance (EIA-455-41)	2000 N/cm
Impact Resistance (EIA-455-25)	2000 Impacts @ 1.6 N-m
Cyclic Flexing (EIA-455-104)	2000 cycles, min.
Min. Bend Radius	
Installation	20 x OD
Long Term	15 x OD
Optical Specifications	See page 10.2

Fiber Bundle Detail

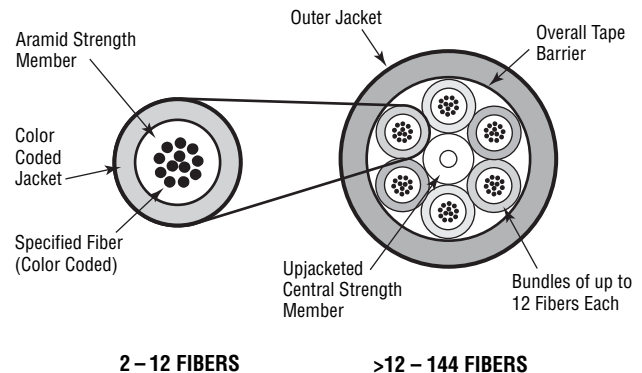

No. of Fibers	Fibers Per Tube	Belden Part Number				Outside Diameter		Weight		Max. Install Load	
		62.5 / 125µm Std. / 1 Gbe	50 / 125µm Std. / 1 Gbe	50 / 125µm 10 Gbe - 300M	Single-mode Enhanced	Inch	mm	Lbs./1000'	kg/km	Lbs.	N

Loose Tube Series

Plenum (NEC/CEC OFNP/OFN FT6)											
6	6	M9B202	M9A202	M9C202	M9W202	0.265	6.70	33	49	320	1423
12	12	M9B204	M9A204	M9C204	M9W204	0.265	6.70	33	49	320	1423
24	12	M9B205	M9A205	M9C205	M9W205	0.359	9.12	47	70	405	1801
36	12	M9B206	M9A206	M9C206	M9W206	0.359	9.12	47	70	405	1801
48	12	M9B207	M9A207	M9C207	M9W207	0.359	9.12	48	71	405	1801
72	12	M9B209	M9A209	M9C209	M9W209	0.429	10.90	71	106	585	2602
96	12	M9B211	M9A211	M9C211	M9W211	0.501	12.73	105	156	903	4017
144	12	M9B215	M9A215	M9C215	M9W215	0.665	16.89	189	281	1263	5618

Alternative fiber counts and hybrid constructions are available. All optical fiber products can be supplied in compliance with RoHS regulations. Please contact Customer Service for more details.

Double Jacket, Armored Cable

Loose Tube – Outdoor, and Indoor/Outdoor Riser Rated

Applications

- Direct burial
- Low to high fiber count requirements
- Inter-building duct installations
- Indoor/outdoor
- Industrial outside plant

Product Description

Gel-filled buffer tube prevents water migration. Available as Riser rated cable, thereby eliminating the need for service entrance splicing to in-building cable. Rodent resistant. Available in sizes up to 216 fibers. Length markings in meters for easy determination of cable length.

Jacket Material	
Outdoor	PE
Riser	PVC
Buffer Tube	
Outdoor	PBT
Riser	PVC
Strength Member	
	Aramid Yarn
Central Strength Member	
	E-Glass
Armor	
	Corrugated Steel Tape
Color Code (Buffer)	
	Per EIA/TIA 598-A, see page 10.2
Jacket Color	
	Black

Ratings

Riser	
UL Type	OFCR
cUL Type	OFC FT4
Flame Resistance	UL 1666

Specifications

Temperature Range (Outdoor)	
Storage	-50 to +80°C
Operating	-40 to +70°C
Temperature Range (Riser)	
Storage	-40 to +80°C
Operating	-40 to +70°C
Crush Resistance (EIA-455-41)	2000 N/cm
Impact Resistance (EIA-455-25)	2000 Impacts @ 1.6 N-m
Min. Bend Radius	
Installation	20 x OD
Long Term	15 x OD
Optical Specifications	See page 10.2

Fiber Bundle Detail

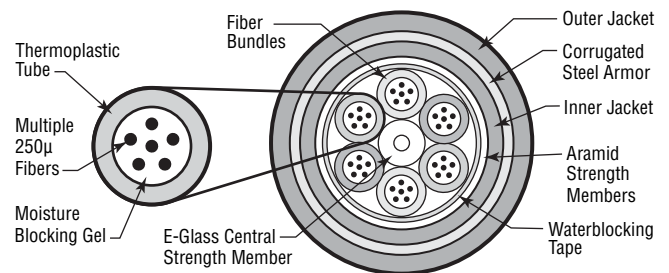

No. of Fibers	Fibers Per Tube	Belden Part Number				Outside Diameter		Weight		Max. Install Load	
		62.5 / 125µm Std. / 1 Gbe	50 / 125µm Std. / 1 Gbe	50 / 125µm 10 Gbe – 300M	Single-mode Enhanced	Inch	mm	Lbs./1000'	kg/km	Lbs.	N

Loose Tube Series — Armored

Outdoor											
6	6	M9B381T	M9A381T	M9C381T	M9W381T	0.53	13.46	101	150	600	2700
12	6	M9B382T	M9A382T	M9C382T	M9W382T	0.53	13.46	102	152	600	2700
24	6	M9B384T	M9A384T	M9C384T	M9W384T	0.53	13.46	103	153	600	2700
36	6	M9B386T	M9A386T	M9C386T	M9W386T	0.53	13.46	103	153	600	2700
48	12	M9B389T	M9A389T	M9C389T	M9W389T	0.65	16.51	144	214	600	2700
72	12	M9B391T	M9A391T	M9C391T	M9W391T	0.65	16.51	142	211	600	2700
96	12	M9B398T	M9A398T	M9C398T	M9W398T	0.69	17.53	168	250	600	2700
144	12	M9B393T	M9A393T	M9C393T	M9W393T	0.87	22.10	241	359	600	2700
216	12	M9B400T	M9A400T	M9C400T	M9W400T	0.87	22.10	241	359	600	2700
Riser (NEC/CEC OFCR/OFC FT4)											
6	6	M9B890	M9A890	M9C890	M9W890	0.54	13.72	138	205	600	2700
12	6	M9B891	M9A891	M9C891	M9W891	0.54	13.72	137	204	600	2700
24	6	M9B892	M9A892	M9C892	M9W892	0.54	13.72	136	202	600	2700
36	6	M9B893	M9A893	M9C893	M9W893	0.54	13.72	135	201	600	2700
48	12	M9B894	M9A894	M9C894	M9W894	0.66	16.76	176	262	600	2700
72	12	M9B895	M9A895	M9C895	M9W895	0.66	16.76	172	256	600	2700
96	12	M9B896	M9A896	M9C896	M9W896	0.70	17.78	206	307	600	2700
144	12	M9B897	M9A897	M9C897	M9W897	0.88	22.35	302	449	600	2700

All optical fiber products can be supplied in compliance with RoHS regulations. Please contact Customer Service for more details.



For more information, contact Belden Technical Support: 1-800-BELDEN-1 • www.belden.com

Double Jacket, Heavy-Duty Cable

Loose Tube — Outdoor

Applications

- Direct burial
- Harsh environments
- Applications requiring good ozone-, moisture- and weather-resistance

Product Description

Gel-filled buffer tube prevents water migration. Available with up to 216 fibers.

Jacket Material	
Outer Jacket:	PE
Inner Jacket:	PE
Buffer Tube	
	PBT
Strength Member	
	Aramid Yarn
Central Strength Member	
	E-Glass
Core Wrap	
	Water Swellable Tape
Color Code (Buffer)	
	Per EIA/TIA 598-A, see page 10.2
Jacket Color	
	Black

Specifications

Temperature Range	
Storage	-50 to +80°C
Operating	-40 to +70°C
Crush Resistance (EIA-455-41)	
	2000 N/cm
Impact Resistance (EIA-455-25)	
	2000 Impacts @ 1.6 N-m
Min. Bend Radius	
Installation	20 x OD
Long Term	15 x OD
Optical Specifications	
	See page 10.2

Fiber Bundle Detail

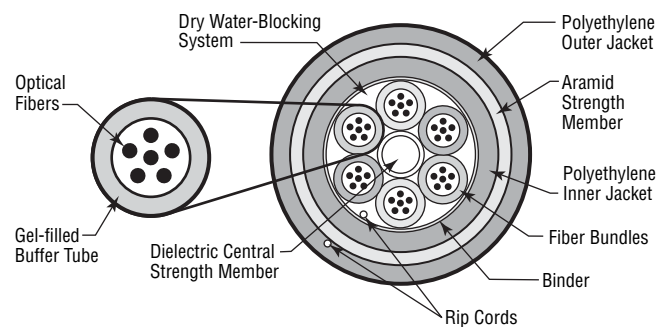

No. of Fibers	Fibers Per Tube	Belden Part Number				Outside Diameter		Weight		Max. Install Load	
		62.5 / 125µm Std. / 1 Gbe	50 / 125µm Std. / 1 Gbe	50 / 125µm 10 Gbe – 300M	Single-mode Enhanced	Inch	mm	Lbs./1000'	kg/km	Lbs.	N

Loose Tube Series — Heavy Duty

Outdoor											
2	2	M9B840	M9A840	M9C840	M9W840	0.44	11.18	60	89	600	2700
4	4	M9B841	M9A841	M9C841	M9W841	0.44	11.18	60	89	600	2700
6	6	M9B842	M9A842	M9C842	M9W842	0.44	11.18	60	89	600	2700
8	4	M9B843	M9A843	M9C843	M9W843	0.44	11.18	60	89	600	2700
12	6	M9B844	M9A844	M9C844	M9W844	0.44	11.18	60	89	600	2700
18	6	M9B845	M9A845	M9C845	M9W845	0.44	11.18	60	89	600	2700
24	6	M9B846	M9A846	M9C846	M9W846	0.44	11.18	60	89	600	2700
36	6	M9B847	M9A847	M9C847	M9W847	0.44	11.18	60	89	600	2700
48	12	M9B848	M9A848	M9C848	M9W848	0.54	13.72	136	202	600	2700
72	12	M9B849	M9A849	M9C849	M9W849	0.54	13.72	136	202	600	2700
96	12	M9B820	M9A820	M9C820	M9W820	0.61	15.37	152	226	600	2700
144	12	M9B821	M9A821	M9C821	M9W821	0.76	19.30	255	379	600	2700
216	12	M9B822	M9A822	M9C822	M9W822	0.76	19.30	255	379	600	2700

All optical fiber products can be supplied in compliance with RoHS regulations. Please contact Customer Service for more details.

Central Tube Cable

Loose Tube—Outdoor, and Outdoor Armored

Applications

- Campus OSP backbones
- Drop cable
- Telecommunications and data trunk
- Direct burial (armored only)
- Lashed aerial

Product Description

Economical option for low fiber counts. Quick and easy end preparation. Fully waterblocked with gel-filled buffer tube. No rods – easy handling. Crush, impact and abrasion resistant.

Jacket Material	PE
Buffer Tube	PBT
Core Wrap	Water Swellable Tape
Strength Member	Fiberglass
Armor	Corrugated Steel
Color Codes (Jacket & Fibers)	Per EIA/TIA 598-A, see page 10.2
Jacket Color	Black

Specifications

Temperature Range	
Storage	-40 to +70°C
Operating	-40 to +70°C
Crush Resistance (EIA-455-41)	2000 N/cm
Impact Resistance (EIA-455-25)	2000 Impacts @ 1.6 N-m
Min. Bend Radius	
Installation	20 x OD
Long Term	15 x OD
Optical Specifications	See page 10.2

Fiber Bundle Detail

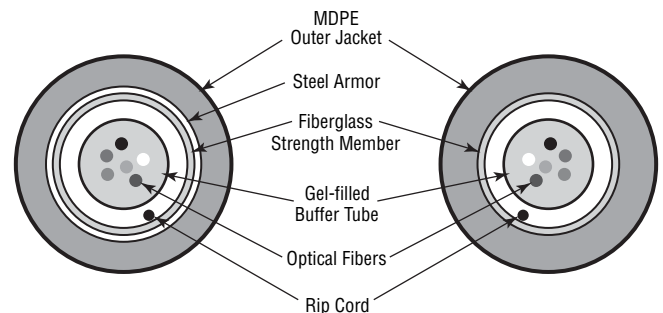

SINGLE ARMOR

ALL DIELECTRIC

No. of Fibers	Belden Part Number				Outside Diameter		Weight		Max. Install Load	
	62.5 / 125µm Std. / 1 Gbe	50 / 125µm Std. / 1 Gbe	50 / 125µm 10 Gbe – 300M	Single-mode Enhanced	Inch	mm	Lbs./1000'	kg/km	Lbs.	N

Central Tube Series

Outdoor										
2	M9B150	M9A150	M9C150	M9W150	0.325	8.26	36	54	600	2700
4	M9B151	M9A151	M9C151	M9W151	0.325	8.26	36	54	600	2700
6	M9B152	M9A152	M9C152	M9W152	0.325	8.26	36	54	600	2700
8	M9B153	M9A153	M9C153	M9W153	0.325	8.26	36	54	600	2700
10	M9B154	M9A154	M9C154	M9W154	0.325	8.26	36	54	600	2700
12	M9B155	M9A155	M9C155	M9W155	0.325	8.26	36	54	600	2700
Outdoor Armored										
2	M9B170	M9A170	M9C170	M9W170	0.410	10.41	72	108	600	2700
4	M9B171	M9A171	M9C171	M9W171	0.410	10.41	72	108	600	2700
6	M9B172	M9A172	M9C172	M9W172	0.410	10.41	72	108	600	2700
8	M9B173	M9A173	M9C173	M9W173	0.410	10.41	72	108	600	2700
10	M9B174	M9A174	M9C174	M9W174	0.410	10.41	72	108	600	2700
12	M9B175	M9A175	M9C175	M9W175	0.410	10.41	72	108	600	2700

All optical fiber products can be supplied in compliance with RoHS regulations. Please contact Customer Service for more details.

Micro Loose Tube Breakout Style Cable

Loose Tube – Outdoor, Indoor/Outdoor OFN & Indoor/Outdoor Riser Rated

Applications

- Ducts between buildings (above or below frost lines)
- Lashed aerial
- Telecommunications and data trunk

Product Description

Easy handling and termination of a breakout style cable. Loose buffer dimensions compatible with standard connectors (900 µm). Waterblocking gel for moisture protection. Breakout kits not required for connectorization.

Jacket Material

Outdoor	PE
Riser	PVC
General Purpose	TPE

Buffer tube

Outdoor + Riser	PBT
-----------------	-----

Strength Elements

Aramid Yarn

Strength Member(s)

Upjacketed Aramid

Color Codes (Jacket & Fibers)

Per EIA/TIA 598-A,
see page 10.2

Jacket Color

Black

Ratings

Riser

UL Type	OFNR
cUL Type	OFN FT4
Flame Resistance	UL 1666

General Purpose

UL/cUL Type	OFN
Flame Resistance	UL 1581

Specifications

Temperature Range

Storage	-40 to +70°C
Operating	-20 to +70°C

Crush Resistance (EIA-455-41)

600 N/cm

Impact Resistance (EIA-455-25)

20 Impacts @ 1.0 N-m

Min. Bend Radius

Installation	20 x OD
Long Term	15 x OD

Optical Specifications

See page 10.2

Fiber Bundle Detail

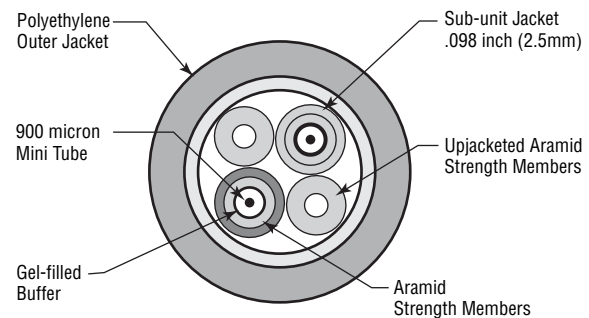

Micro Loose Tube Breakout Style Cable

Loose Tube – Outdoor, Indoor/Outdoor OFN & Indoor/Outdoor Riser Rated (*continued*)

No. of Fibers	Belden Part Number				Outside Diameter		Weight		Max. Install Load	
	62.5 / 125µm Std. / 1 Gbe	50 / 125µm Std. / 1 Gbe	50 / 125µm 10 Gbe – 300M	Single-mode Enhanced	Inch	mm	Lbs./1000'	kg/km	Lbs.	N
Micro Loose Tube Series										
Outdoor										
1	M9B700	M9A700	M9C700	M9W700	0.340	8.64	41	61	330	1468
2	M9B701	M9A701	M9C701	M9W701	0.360	9.14	41	61	345	1535
4	M9B702	M9A702	M9C702	M9W702	0.360	9.14	39	58	285	1267
6	M9B703	M9A703	M9C703	M9W703	0.418	10.62	54	80	405	1801
8	M9B704	M9A704	M9C704	M9W704	0.478	12.14	76	113	600	2700
12	M9B705	M9A705	M9C705	M9W705	0.614	15.60	129	192	600	2700
Indoor/Outdoor OFN										
1	M9B720	M9A720	M9C720	M9W720	0.344	8.74	50	74	330	1468
2	M9B721	M9A721	M9C721	M9W721	0.364	9.25	51	76	345	1535
4	M9B722	M9A722	M9C722	M9W722	0.364	9.25	49	73	285	1267
6	M9B723	M9A723	M9C723	M9W723	0.424	10.72	68	101	405	1801
8	M9B724	M9A724	M9C724	M9W724	0.482	12.24	77	115	600	2700
12	M9B725	M9A725	M9C725	M9W725	0.618	15.70	130	193	600	2700
Indoor/Outdoor Riser										
1	M9B740	M9A740	M9C740	M9W740	0.352	8.94	54	80	330	1468
2	M9B741	M9A741	M9C741	M9W741	0.372	9.45	55	82	345	1535
4	M9B742	M9A742	M9C742	M9W742	0.372	9.45	51	76	285	1267
6	M9B743	M9A743	M9C743	M9W743	0.432	10.97	74	110	405	1801
8	M9B744	M9A744	M9C744	M9W744	0.490	12.45	94	140	600	2700
12	M9B745	M9A745	M9C745	M9W745	0.626	15.90	151	229	600	2700

Please contact the Technical Support Group for proper connectivity integration and installation guidance.
All optical fiber products can be supplied in compliance with RoHS regulations. Please contact Customer Service for more details.

TrayOptic® Heavy-Duty, All Dielectric Cable

Loose Tube — Indoor/Outdoor Riser Rated

Applications

- Industrial and other harsh environment applications
- Factory automation
- Direct burial

Product Description

Laser Optimized Fiber to handle Gigabit Ethernet light sources and expanded bandwidth requirements. Passes IEEE 383-2003 flame test. Waterblocking agent for moisture protection. CPE outer jacket option provides extra chemical or abrasion resistance.

Fiber Type	62.5/125μ
Jacket Material	PVC or CPE
Strength Member	Aramid Yarn
Jacket Color	Orange

Ratings

Riser	
UL Type	OFNR
cUL Type	OFN FT4
Flame Resistance	IEEE 383-2003

Specifications

Temperature Range	
Storage	-40 to +70°C
Operating	-40 to +70°C
Crush Resistance (EIA-455-41)	2000 N/cm
Impact Resistance (EIA-455-25)	2000 impacts @ 1.6N-m
Cyclic Flexing (EIA-455-104)	25 cycles, 12 lbs., 20 x OD radius min.
Min. Bend Radius	
Installation	20 x OD
Long Term	15 x OD
Maximum Installation Load	600 lbs. (2700 N)
Optical Specifications	See page 10.2

Fiber Bundle Detail

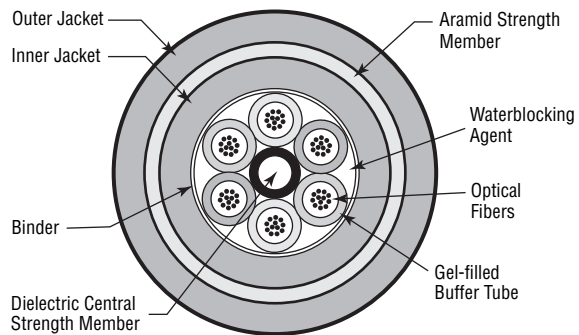

No. of Fibers	Fibers Per Tube	Outside Diameter		PVC Jacket			CPE Jacket		
		Inches	mm	Belden Part No.	Weight Lbs./1000'	Weight kg/km	Belden Part No.	Weight Lbs./1000'	Weight kg/km

TrayOptic Series

Riser (NEC/CEC OFNR/OFN FT4)									
2	2	0.440	11.18	I100255	88	131	I100266	83	124
4	4	0.440	11.18	I100455	88	131	I100466	83	124
6	6	0.440	11.18	I100655	88	131	I100666	83	124
8	4	0.440	11.18	I400855	88	131	I400866	83	124
12	6	0.440	11.18	I601255	88	131	I601266	83	124
18	6	0.440	11.18	I601855	88	131	I601866	83	124
24	6	0.440	11.18	I602455	88	131	I602466	83	124
36	6	0.440	11.18	I603655	88	131	I603666	83	124
48	12	0.540	13.72	I604855	136	202	I604866	129	192
60	12	0.540	13.72	I606055	136	202	I606066	129	192
72	12	0.540	13.72	I607255	136	202	I607266	129	192

All optical fiber products can be supplied in compliance with RoHS regulations. Please contact Customer Service for more details.



11 Enclosures and Accessories

Table of Contents

Enclosures and Accessories	Page No.
Introduction	11.2
Modular Enclosures	11.3–11.19
Data Standard Enclosure: 29"W x 30"D	11.3
Data Standard Enclosure: 29"W x 34"D	11.6
Data Slim Enclosure: 24"W x 30"D	11.9
Ultra Server Enclosure: 24"W x 36"D	11.12
Ultra Deep Server Enclosure: 24"W x 42"D	11.15
Giga Server Enclosure: 26"W x 42"D	11.18
Modular Enclosure Options and Accessories	11.20–11.27
Enclosure Shelves	11.20
Enclosure Anti-Tip Device	11.22
Grounding Bars	11.22
Enclosure Mounting Hardware	11.22
Enclosure Mounting Rails	11.23
Enclosure Partial Rail Kits	11.23
Front to Rear Cable Management	11.24
Light Kits	11.24
Enclosure Power Strips	11.25
Mission Critical Power Accessories	11.26
Climate Monitor	11.27
Electronic Fan Controller	11.27
Thermostat Fan Controller	11.27
Wall Mount Enclosures and Accessories	11.28–11.30
Wall Mount Enclosures	11.28
Wall Mount Enclosure Accessories	11.29
Swing Racks	11.29



Introduction

Belden: Resources Of a Higher Magnitude

Belden is the largest company of its kind, combining cable, connectivity, enclosures and many other product solutions for highly technical industries around the globe. As the exclusive occupant in this market position, Belden provides thousands of satisfied customers with over a billion dollars worth of trusted solutions every year, much of which supports the commercial networking sector. By combining our expertise in the design and manufacture of cable, connectivity, enclosures and related products, Belden now offers a product line of staggering magnitude, engineering triumphs and rich resources — worldwide.

Belden Enclosures

The complete line of Belden Enclosure solutions are designed to meet the unique needs of data networks and control console systems. Whether it's the protection of sensitive data equipment, the ability to mount equipment of varied sizes and depths, or the need to organize and neatly route installed cable, Belden has the solution you need. Belden provides you with single source convenience for all of your cable management requirements.

Enclosures and Racks

Choose from a variety of vertical enclosures, open frame racks and wall mount enclosures, all expertly engineered to optimize product quality and performance and manufactured in the United States for quick availability. Although standard configurations of the most popular enclosures are offered for fast delivery needs, all custom enclosures and racks have numerous mounting, cable and patch cord management options, along with a variety of accessories. This selection of Belden enclosures and racks will meet virtually any mounting, storage or protection requirement for your application.

Single Sourcing Convenience

The Cable Management product families in this catalog are offered to cabling professionals for ultimate convenience in single sourcing. As a Belden customer, you also have the assurance of total dependability by working with a market leader and a trusted partner who has a vested interest in optimizing your operations and investments. We want to make sure you not only get the products you need with ease, but they also perform reliably.

Freestanding Modular Enclosures

Type	Rack Space	Heights (inches)	Panel Mount (inches)	Width (inches)	Depth (inches)
Data Standard	25, 39, 42, 46U	48, 72, 78, 84	19 or 23	29	30
Data Deep	39, 42, 46U	72, 78, 84	19 or 23	29	34
Data Slim	25, 39, 42, 46U	48, 72, 78, 84	19	24	30
Ultra Server	42U, 45U	78, 84	19	24	36
Ultra Deep Server	45U	84	19	24	42
Giga Server	45U	84	19	26	42

Modular Enclosures

Data Standard Enclosure 29" Wide x 30" Deep

BST-Style Data Standard Enclosure



Data Standard Enclosure

The Data Standard is a freestanding enclosure that easily accommodates large components. The unit's mounting rails can be adjusted, after installation, from 19" EIA to 23" EIA spacing to allow for cable management and different depths of equipment. Among the many features and benefits of this modular unit are:

- **Reversible Doors:** Spring-loaded hinges allow quick change of door swing.
- **Lift-off Side Panels:** Flush surface lock fasteners permit quick disconnect and lift off.
- **Cable Gland Plate:** Adjustable bottom plate minimizes dirt and dust inside the enclosure.
- **Cable Access Top:** Features a 14.25" x 4" cable access rubber gland which helps prevent dust from entering the enclosure.
- **Rear Cable Plate:** Two, 3-7/8" x 8-1/2" openings for cable access with removable plates and edge grommet kit. Also features two 1.75" capped openings.
- **Tempered Safety Glass:** Strengthens door and its easy-to-clean, non-scratching, tinted bronze color enhances overall appearance.
- **Grounding kit Included.**

Frames



BST 48

BST 72

BST 78

BST 84

These products are in the process of being assessed for RoHS compliance. Please check our Web Site for the most current RoHS status.

Modular Enclosures

Data Standard Enclosure

29" Wide x 30" Deep (continued)

Dimensions

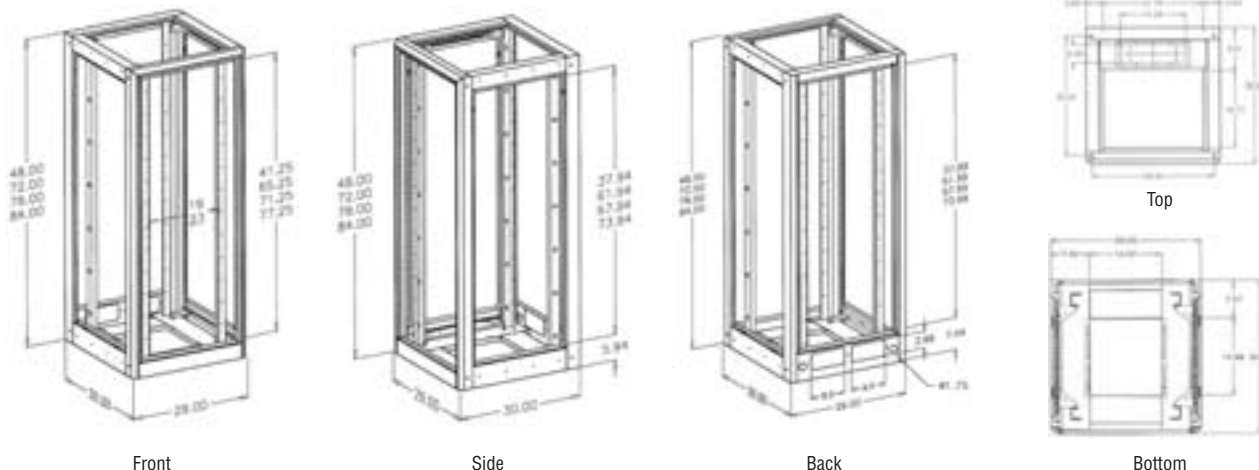

Technical Specifications

Enclosure Size		H	W	D	Weight	Mounting	Rack Spaces
BST48	Frame, Gland Plate, Casters & Levelers	48"	29"	30"	230 lb	19", 23" or Frame Mount Shelf	25U
BST72	Frame, Gland Plate, Casters & Levelers	72"	29"	30"	325 lb	19", 23" or Frame Mount Shelf	39U
BST78	Frame, Gland Plate, Casters & Levelers	78"	29"	30"	350 lb	19", 23" or Frame Mount Shelf	42U
BST84	Frame, Gland Plate, Casters & Levelers	84"	29"	30"	360 lb	19", 23" or Frame Mount Shelf	46U

EIA - 310 - D Compliant

Description	Belden Part Number
Data Standard 84" Black, 19" Mounting, 10" Fan Top, Glass Door, Vented Rear Door, Two Sides, 20 Amp Power Strip	BST84-3-122226
Data Standard 84" Black Frames w/19" Mounting	BST84-3-100000

How To Order

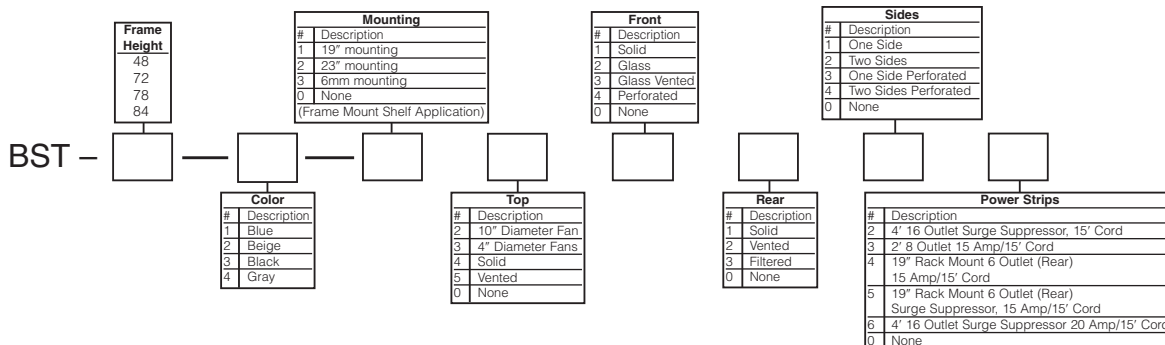

These products are in the process of being assessed for RoHS compliance. Please check our Web Site for the most current RoHS status.



Modular Enclosures

Data Standard Enclosure

29" Wide x 30" Deep (continued)

Solid Front Door



Tempered Glass Front Door



Rear Doors: Solid, Vented, Filtered



Side Panels

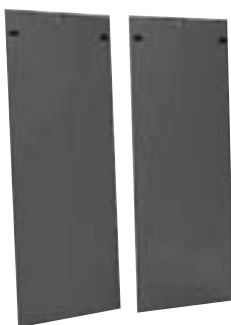

Removable Tops



Description	Belden Part Number
Front Doors	
Solid Front Door	
Solid Steel Front Door with Latch and Lock, 48"	B4829-SF-C
Solid Steel Front Door with Latch and Lock, 72"	B7229-SF-C
Solid Steel Front Door with Latch and Lock, 78"	B7829-SF-C
Solid Steel Front Door with Latch and Lock, 84"	B8429-SF-C
Tempered Glass Front Door	
Tempered Glass Front Door with Latch and Lock, 48"	B4829-GF-C
Tempered Glass Front Door with Latch and Lock, 72"	B7229-GF-C
Tempered Glass Front Door with Latch and Lock, 78"	B7829-GF-C
Tempered Glass Front Door with Latch and Lock, 84"	B8429-GF-C
Glass Vented Front Door	
Tempered Glass Front Vented Door with Latch and Lock, 48"	B4829-VF-C
Tempered Glass Front Vented Door with Latch and Lock, 72"	B7229-VF-C
Tempered Glass Front Vented Door with Latch and Lock, 78"	B7829-VF-C
Tempered Glass Front Vented Door with Latch and Lock, 84"	B8429-VF-C
Perforated Front Door	
Perforated Front Door with Latch and Lock, 48"	B4829-PD-C
Perforated Front Door with Latch and Lock, 72"	B7229-PD-C
Perforated Front Door with Latch and Lock, 78"	B7829-PD-C
Perforated Front Door with Latch and Lock, 84"	B8429-PD-C
Rear Doors	
Solid Rear Door	
Solid Steel Rear Door with Latch and Lock, 48"	B4829-SR-C
Solid Steel Rear Door with Latch and Lock, 72"	B7229-SR-C
Solid Steel Rear Door with Latch and Lock, 78"	B7829-SR-C
Solid Steel Rear Door with Latch and Lock, 84"	B8429-SR-C
Vented Rear Door	
Vented Steel Rear Door with Latch and Lock, 48"	B4829-VR-C
Vented Steel Rear Door with Latch and Lock, 72"	B7229-VR-C
Vented Steel Rear Door with Latch and Lock, 78"	B7829-VR-C
Vented Steel Rear Door with Latch and Lock, 84"	B8429-VR-C
Filtered Rear Door	
Filtered Rear Door with Latch and Lock, 48"	B4829-FR-C
Filtered Rear Door with Latch and Lock, 72"	B7229-FR-C
Filtered Rear Door with Latch and Lock, 78"	B7829-FR-C
Filtered Rear Door with Latch and Lock, 84"	B8429-FR-C
Side Panels	
Single Side Panels	
1-Solid Lift-off Side Panel with Lock, 48"	B4801-SP-C
1-Solid Lift-off Side Panel with Lock, 72"	B7201-SP-C
1-Solid Lift-off Side Panel with Lock, 78"	B7801-SP-C
1-Solid Lift-off Side Panel with Lock, 84"	B8401-SP-C
Pair of Side Panels	
2-Solid Lift-off Side Panels with Lock, 48"	B4802-SP-C
2-Solid Lift-off Side Panels with Lock, 72"	B7202-SP-C
2-Solid Lift-off Side Panels with Lock, 78"	B7802-SP-C
2-Solid Lift-off Side Panels with Lock, 84"	B8402-SP-C
Removable Tops	
Solid Top	B2918-TP-1-C
Vented Top	B2918-TP-2-C
Solid Top with 10" Diameter Fan, 550 CFM	B2918-TP-3-C
Solid Top with (4) 4" Diameter Fans, Four Fans = 320 CFM	B2918-TP-4-C

These products are in the process of being assessed for RoHS compliance. Please check our Web Site for the most current RoHS status.

Modular Enclosures

Data Deep Enclosure

29" Wide x 34" Deep

BDP-Style Data Deep Enclosure



Data Deep Enclosure

The Data Deep is a freestanding enclosure that features a 34" depth for mounting servers, UPS units, controllers, battery backups, network monitors and more. The unit's mounting rails can be adjusted, after installation, from 19" EIA to 23" EIA spacing to allow for cable management and different depths of equipment. Among the many features and benefits of this modular unit are:

- **Reversible Doors:** Spring-loaded hinges allow quick change of door swing.
- **Lift-off Side Panels:** Flush surface lock fasteners permit quick disconnect and lift off.
- **Cable Gland Plate:** Adjustable bottom plate minimizes dirt and dust inside the enclosure.
- **Cable Access Top:** Features a 14.25" x 4" cable access rubber gland which helps prevent dust from entering the enclosure.
- **Rear Cable Plate:** Two, 3-7/8" x 8-1/2" openings for cable access with removable plates and edge grommet kit. Also features two 1.75" capped openings.
- **Tempered Safety Glass:** Strengthens door and its easy-to-clean, non-scratching, tinted bronze color enhances overall appearance.
- **Grounding kit Included.**

Frames



BDP 72



BDP 78



BDP 84

These products are in the process of being assessed for RoHS compliance. Please check our Web Site for the most current RoHS status.

Modular Enclosures

Data Deep Enclosure
29" Wide x 34" Deep (continued)

Dimensions

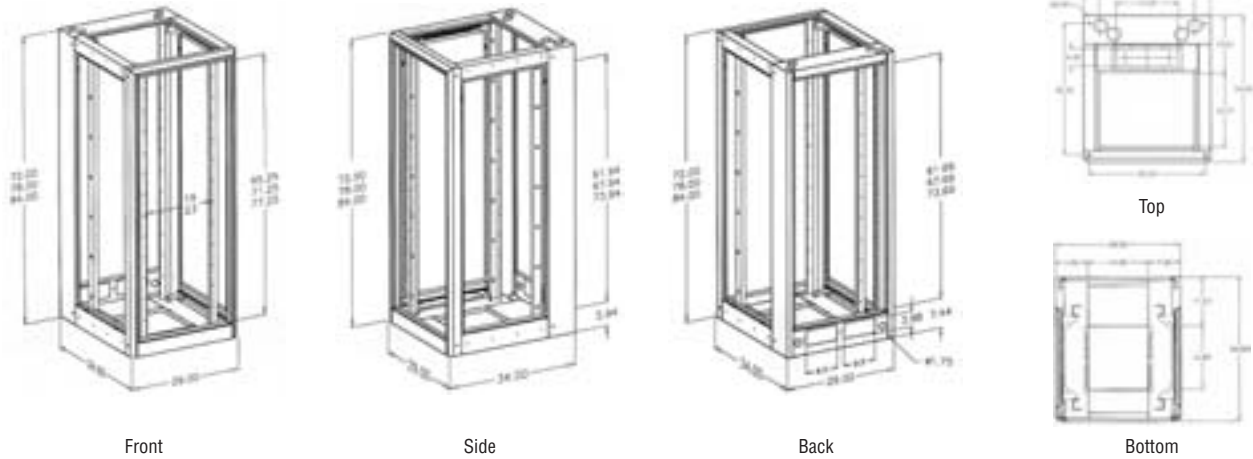

Technical Specifications

Enclosure Size		H	W	D	Weight	Mounting	Rack Spaces
BDP72	Frame, Gland Plate, Casters & Levelers	72"	29"	34"	350 lb	19", 23" or Frame Mount Shelf	39U
BDP78	Frame, Gland Plate, Casters & Levelers	78"	29"	34"	380 lb	19", 23" or Frame Mount Shelf	42U
BDP84	Frame, Gland Plate, Casters & Levelers	84"	29"	34"	390 lb	19", 23" or Frame Mount Shelf	46U

EIA - 310 - D Compliant

Description	Belden Part Number
Data Deep 84" Black, 19" Mounting, 10" Fan Top, Glass Door, Vented Rear Door, Two Sides, 20 Amp Power Strip	BDP84-3-122226
Data Deep 84" Black Frames w/19" Mounting	BDP84-3-100000

How To Order

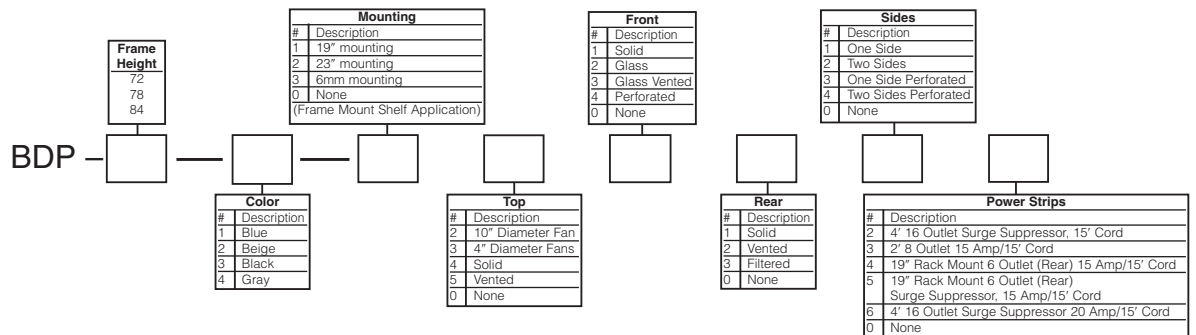

These products are in the process of being assessed for RoHS compliance. Please check our Web Site for the most current RoHS status.



For more information, contact Belden Technical Support: 1-800-BELDEN-1 • www.belden.com

Modular Enclosures

Data Deep Enclosure

29" Wide x 34" Deep (continued)

Tempered Glass Front Door



Rear Doors: Solid, Vented, Filtered



Side Panels

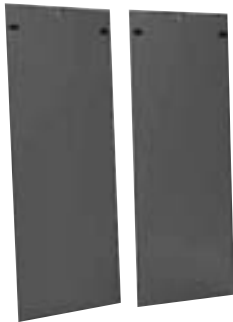

Removable Tops



Description	Belden Part Number
Front Doors	
Solid Front Door	
Solid Steel Front Door with Latch and Lock, 72"	B7229-SF-C
Solid Steel Front Door with Latch and Lock, 78"	B7829-SF-C
Solid Steel Front Door with Latch and Lock, 84"	B8429-SF-C
Tempered Glass Front Door	
Tempered Glass Front Door with Latch and Lock, 72"	B7229-GF-C
Tempered Glass Front Door with Latch and Lock, 78"	B7829-GF-C
Tempered Glass Front Door with Latch and Lock, 84"	B8429-GF-C
Glass Vented Front Door	
Tempered Glass Front Vented Door with Latch and Lock, 72"	B7229-VF-C
Tempered Glass Front Vented Door with Latch and Lock, 78"	B7829-VF-C
Tempered Glass Front Vented Door with Latch and Lock, 84"	B8429-VF-C
Perforated Front Door	
Perforated Front Door with Latch and Lock, 72"	B7229-PD-C
Perforated Front Door with Latch and Lock, 78"	B7829-PD-C
Perforated Front Door with Latch and Lock, 84"	B8429-PD-C
Rear Doors	
Solid Rear Door	
Solid Steel Rear Door with Latch and Lock, 72"	B7229-SR-C
Solid Steel Rear Door with Latch and Lock, 78"	B7829-SR-C
Solid Steel Rear Door with Latch and Lock, 84"	B8429-SR-C
Vented Rear Door	
Vented Steel Rear Door with Latch and Lock, 72"	B7229-VR-C
Vented Steel Rear Door with Latch and Lock, 78"	B7829-VR-C
Vented Steel Rear Door with Latch and Lock, 84"	B8429-VR-C
Filtered Rear Door	
Filtered Rear Door with Latch and Lock, 72"	B7229-FR-C
Filtered Rear Door with Latch and Lock, 78"	B7829-FR-C
Filtered Rear Door with Latch and Lock, 84"	B8429-FR-C
Side Panels	
Single Side Panel	
1-Solid Lift-off Side Panel with Lock, 72"	B7201-SP-C
1-Solid Lift-off Side Panel with Lock, 78"	B7801-SP-C
1-Solid Lift-off Side Panel with Lock, 84"	B8401-SP-C
Pair of Side Panels	
2-Solid Lift-off Side Panels with Lock, 72"	B7202-SP-C
2-Solid Lift-off Side Panels with Lock, 78"	B7802-SP-C
2-Solid Lift-off Side Panels with Lock, 84"	B8402-SP-C
Removable Tops	
Solid Top	B2918-TP-1-C
Vented Top	B2918-TP-2-C
Solid Top with 10" Diameter Fan, 550 CFM	B2918-TP-3-C
Solid Top with (4) 4" Diameter Fans, Four Fans = 320 CFM	B2918-TP-4-C

These products are in the process of being assessed for RoHS compliance. Please check our Web Site for the most current RoHS status.

Modular Enclosures

Data Slim Enclosure 24" Wide x 30" Deep

BSL-Style Data Slim Enclosure



Data Slim Enclosure

The Data Slim is a freestanding enclosure with a 24" footprint. This makes the enclosure ideal for computer rooms where space is at a premium. The unit's mounting rails have 19" EIA spacing to allow for cable management and different depths of equipment. Among the many features and benefits of this modular unit are:

- **Reversible Doors:** Spring-loaded hinges allow quick change of door swing.
- **Lift-off Side Panels:** Flush surface lock fasteners permit quick disconnect and lift off.
- **Cable Gland Plate:** Adjustable bottom plate minimizes dirt and dust inside the enclosure.
- **Cable Access Top:** Features a 14.25" x 4" cable access rubber gland which helps prevent dust from entering the enclosure.
- **Rear Cable Plate:** One, 3-7/8" x 8-1/2" openings for cable access with a removable plate and edge grommet kit. Also features two 1.75" capped openings.
- **Tempered Safety Glass:** Strengthens door and its easy-to-clean, non-scratching, tinted bronze color enhances overall appearance.
- **Grounding kit Included.**

Frames



BSL 48

BSL 72

BSL 78

BSL 84

These products are in the process of being assessed for RoHS compliance. Please check our Web Site for the most current RoHS status.

Modular Enclosures

Data Slim Enclosure

24" Wide x 30" Deep (continued)

Dimensions

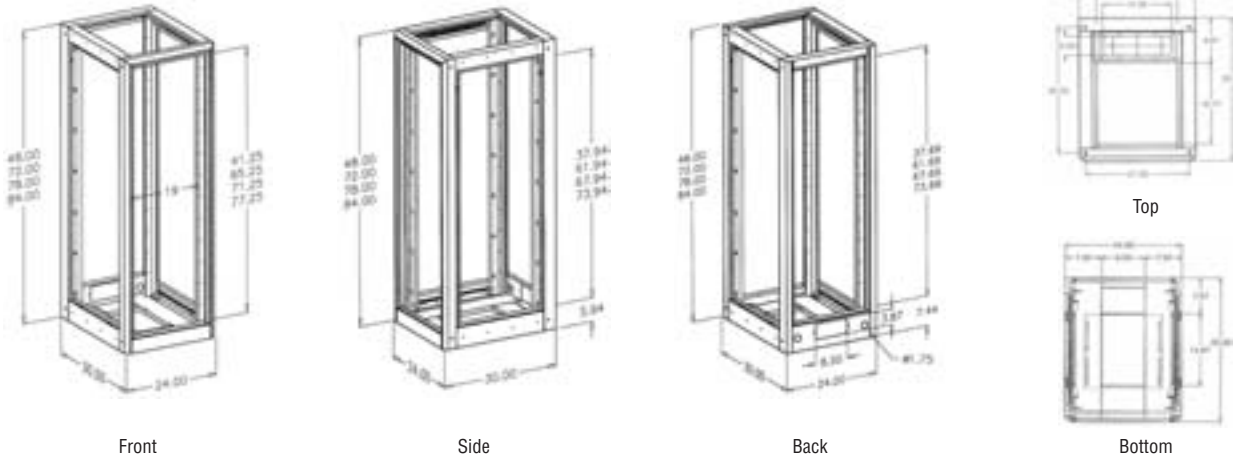

Technical Specifications

Enclosure Size		H	W	D	Weight	Mounting	Rack Spaces
BSL48	Frame, 2 pr 19" mtg Rails, Casters & Levelers	48"	24"	30"	230 lb	19"	25U
BSL72	Frame, 2 pr 19" mtg Rails, Casters & Levelers	72"	24"	30"	320 lb	19"	39U
BSL78	Frame, 2 pr 19" mtg Rails, Casters & Levelers	78"	24"	30"	340 lb	19"	42U
BSL84	Frame, 2 pr 19" mtg Rails, Casters & Levelers	84"	24"	30"	350 lb	19"	46U

EIA - 310 - D Compliant

Description	Belden Part Number
Data Slim 84" Black, 19" Mounting, 10" Fan Top, Glass Door, Vented Rear Door, Two Sides, 20 Amp Power Strip	BSL84-3-122226
Data Slim 84" Black Frames w/19" Mounting	BSL84-3-100000

How To Order

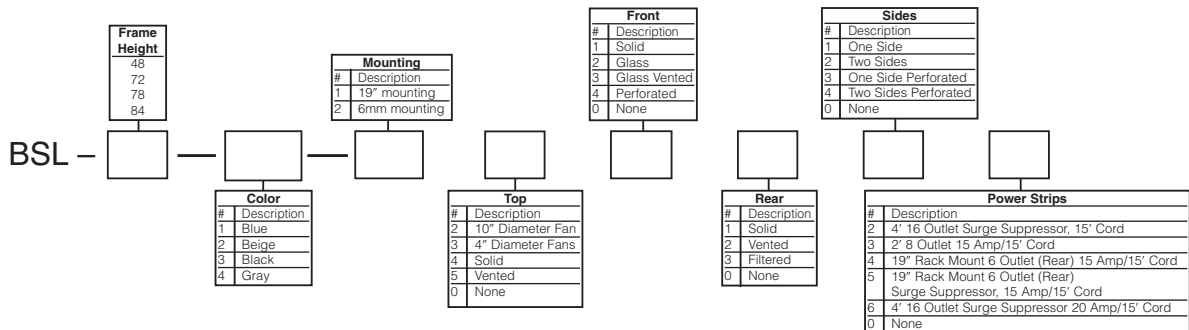

These products are in the process of being assessed for RoHS compliance. Please check our Web Site for the most current RoHS status.



For more information, contact Belden Technical Support: 1-800-BELDEN-1 • www.belden.com

Modular Enclosures

Data Slim Enclosure

24" Wide x 30" Deep (continued)

Solid Front Door



Tempered Glass Front Door

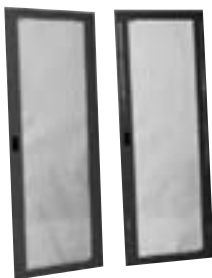

Rear Doors: Solid, Vented, Filtered



Side Panels

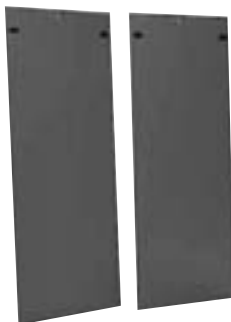

Removable Tops



Description	Belden Part Number
Front Doors	
Solid Front Door	
Solid Steel Front Door with Latch and Lock, 48"	B4824-SF-C
Solid Steel Front Door with Latch and Lock, 72"	B7224-SF-C
Solid Steel Front Door with Latch and Lock, 78"	B7824-SF-C
Solid Steel Front Door with Latch and Lock, 84"	B8424-SF-C
Tempered Glass Front Door	
Tempered Glass Front Door with Latch and Lock, 48"	B4824-GF-C
Tempered Glass Front Door with Latch and Lock, 72"	B7224-GF-C
Tempered Glass Front Door with Latch and Lock, 78"	B7824-GF-C
Tempered Glass Front Door with Latch and Lock, 84"	B8424-GF-C
Glass Vented Front Door	
Tempered Glass Front Vented Door with Latch and Lock, 48"	B4824-VF-C
Tempered Glass Front Vented Door with Latch and Lock, 72"	B7224-VF-C
Tempered Glass Front Vented Door with Latch and Lock, 78"	B7824-VF-C
Tempered Glass Front Vented Door with Latch and Lock, 84"	B8424-VF-C
Perforated Front Door	
Perforated Front Door with Latch and Lock, 48"	B4824-PD-C
Perforated Front Door with Latch and Lock, 72"	B7224-PD-C
Perforated Front Door with Latch and Lock, 78"	B7824-PD-C
Perforated Front Door with Latch and Lock, 84"	B8424-PD-C
Rear Doors	
Solid Rear Door	
Solid Steel Rear Door with Latch and Lock, 48"	B4824-SR-C
Solid Steel Rear Door with Latch and Lock, 72"	B7224-SR-C
Solid Steel Rear Door with Latch and Lock, 78"	B7824-SR-C
Solid Steel Rear Door with Latch and Lock, 84"	B8424-SR-C
Vented Rear Door	
Vented Steel Rear Door with Latch and Lock, 48"	B4824-VR-C
Vented Steel Rear Door with Latch and Lock, 72"	B7224-VR-C
Vented Steel Rear Door with Latch and Lock, 78"	B7824-VR-C
Vented Steel Rear Door with Latch and Lock, 84"	B8424-VR-C
Filtered Rear Door	
Filtered Rear Door with Latch and Lock, 48"	B4824-FR-C
Filtered Rear Door with Latch and Lock, 72"	B7224-FR-C
Filtered Rear Door with Latch and Lock, 78"	B7824-FR-C
Filtered Rear Door with Latch and Lock, 84"	B8424-FR-C
Side Panels	
Single Side Panels	
1-Solid Lift-off Side Panel with Lock, 48"	B4801-SP-C
1-Solid Lift-off Side Panel with Lock, 72"	B7201-SP-C
1-Solid Lift-off Side Panel with Lock, 78"	B7801-SP-C
1-Solid Lift-off Side Panel with Lock, 84"	B8401-SP-C
Pair of Side Panels	
2-Solid Lift-off Side Panels with Lock, 48"	B4802-SP-C
2-Solid Lift-off Side Panels with Lock, 72"	B7202-SP-C
2-Solid Lift-off Side Panels with Lock, 78"	B7802-SP-C
2-Solid Lift-off Side Panels with Lock, 84"	B8402-SP-C
Removable Tops	
Solid Top	B2418-TP-1-C
Vented Top	B2418-TP-2-C
Solid Top with 10" Diameter Fan, 550 CFM	B2418-TP-3-C
Solid Top with (4) 4" Diameter Fans, Four Fans = 320 CFM	B2418-TP-4-C

These products are in the process of being assessed for RoHS compliance. Please check our Web Site for the most current RoHS status.

Modular Enclosures

Ultra Server Enclosure

24" Wide x 36" Deep

BUS-Style Ultra Server Enclosure

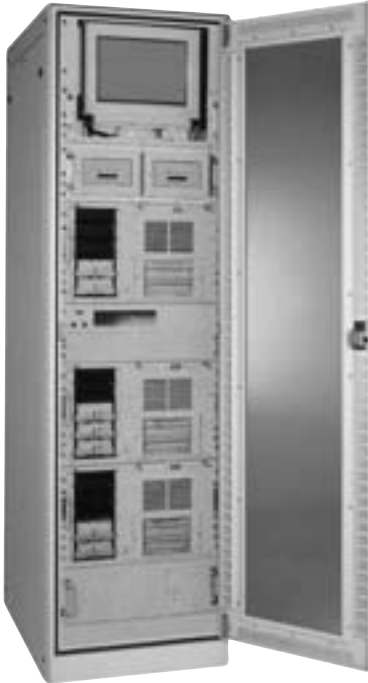

Ultra Server Enclosure

The Ultra Server is a freestanding enclosure with a 24" wide x 36" deep footprint. The enclosure features numerous top and bottom entry points for easy configuration to match your needs and an anti-tip device to prevent the enclosure from tipping when servers and shelves are extended. The unit's mounting rails have 19" EIA spacing to allow for cable management and different depths of equipment. Among the many features and benefits of this modular unit are:

- **Reversible Doors:** Spring-loaded hinges allow quick change of door swing.
- **Lift-off Side Panels:** Flush surface lock fasteners permit quick disconnect and lift off.
- **Door and Side Panel Security:** Doors and side panels lock; handles are flush mounted.
- **Cable Access Top:** Features a 14.25" x 4" cable access rubber gland which helps prevent dust from entering the enclosure.
- **Tempered Safety Glass:** Strengthens door and its easy-to-clean, non-scratching, tinted bronze color enhances overall appearance.
- **Grounding kit Included.**

Frames



BUS 78

BUS 84

These products are in the process of being assessed for RoHS compliance. Please check our Web Site for the most current RoHS status.

Modular Enclosures

Ultra Server Enclosure

24" Wide x 36" Deep (continued)

Dimensions

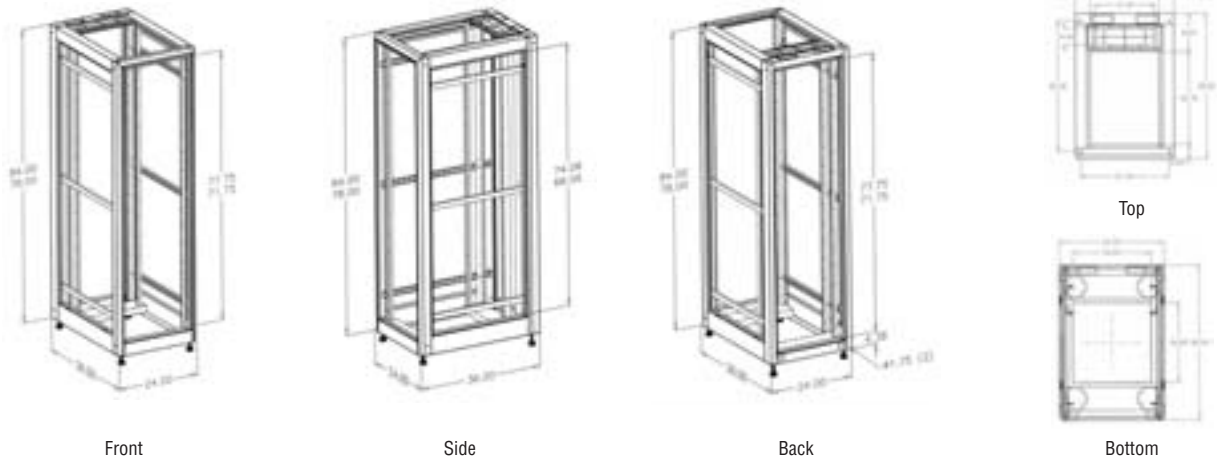

Technical Specifications

Enclosure Size		H	W	D	Weight	Mounting	Rack Spaces
BUS78	Frame, 3 pr 19" Mounting Rails, Casters & Levelers	78"	24"	36"	350 lb	19"	42U
BUS84	Frame, 3 pr 19" Mounting Rails, Casters & Levelers	84"	24"	36"	370 lb	19"	45U

EIA - 310 - D Compliant

Description	Belden Part Number
Ultra Server 84" Black, 19" Mounting, 10" Fan Top, Perforated Slam Front and Rear Doors, Two Sides, 20 Amp Power Strip	BUS84-3-122226
Ultra Server 84" Black Frames w/19" Mounting	BUS84-3-100000

How To Order

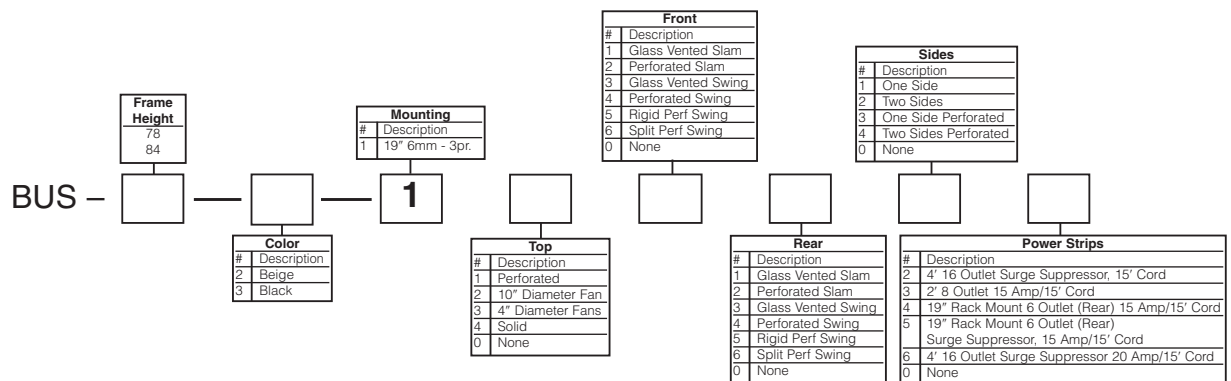

These products are in the process of being assessed for RoHS compliance. Please check our Web Site for the most current RoHS status.



For more information, contact Belden Technical Support: 1-800-BELDEN-1 • www.belden.com

Modular Enclosures

Ultra Server Enclosure

24" Wide x 36" Deep *(continued)*

Tempered Glass Vented Doors



Perforated Doors



Side Panels

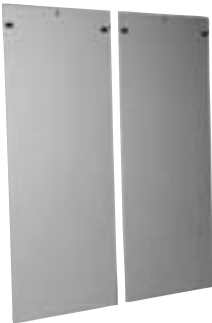

Description	Belden Part Number
Tempered Glass Vented Doors	
Tempered Glass Front/Rear Door with Latch and Lock, 78"	B7824-SVF-C
Tempered Glass Front/Rear Door with Latch and Lock, 84"	B8424-SVF-C
Perforated Door	
Perforated Front/Rear Door with Latch and Lock, 78"	B7824-SPR-C
Perforated Front/Rear Door with Latch and Lock, 84"	B8424-SPR-C

Side Panels

Single Side Panel

1-Solid Lift-off Side Panel with Lock, 78"	B7836-01-SP-C
1-Solid Lift-off Side Panel with Lock, 84"	B8436-01-SP-C

Pair of Side Panels

2-Solid Lift-off Side Panels with Lock, 78"	B7836-02-SP-C
2-Solid Lift-off Side Panels with Lock, 84"	B8436-02-SP-C

Removable Tops/Cooling Devices

Solid Top	B2430-TP-1-C
Solid Top with 10" Diameter Fan, 550 CFM	B2430-TP-3-C
Solid Top with (4) 4" Diameter Fans, Four Fans = 320 CFM	B2430-TP-4-C
Perforated Top	B2430-TP-6-C
19" Fan Tray	B9315-7200

These products are in the process of being assessed for RoHS compliance. Please check our Web Site for the most current RoHS status.

Solid Removable Top w/10" Fan



Solid Removable Top w/ (4) 4" Fans



19" Fan Tray



Modular Enclosures

Ultra Deep Server Enclosure

24" Wide x 42" Deep

BUSD-Style Ultra Deep Server Enclosure



Ultra Deep Server Enclosure

The Ultra Deep Server is a freestanding enclosure with a 24" wide x 42" deep footprint. The enclosure features numerous top and bottom entry points for easy configuration to match your needs and an anti-tip device to prevent the enclosure from tipping when servers and shelves are extended. Among the many features and benefits of this modular unit are:

- **Reversible Doors:** Spring-loaded hinges allow quick change of door swing.
- **Split Rear Doors:** French-style perforated rear doors maximize space between enclosures.
- **Lift-off Side Panels:** Flush surface lock fasteners permit quick disconnect and lift off.
- **Door and Side Panel Security:** Doors and side panels lock; handles are flush mounted.
- **Cable Access Top:** Features a 14.25" x 4" cable access rubber gland which helps prevent dust from entering the enclosure.
- **Tempered Safety Glass:** Strengthens door and its easy-to-clean, non-scratching, tinted bronze color enhances overall appearance.
- **Grounding kit Included.**

Frames



BUSD 84

These products are in the process of being assessed for RoHS compliance. Please check our Web Site for the most current RoHS status.

Modular Enclosures

Ultra Deep Server Enclosure

24" Wide x 42" Deep (continued)

Dimensions

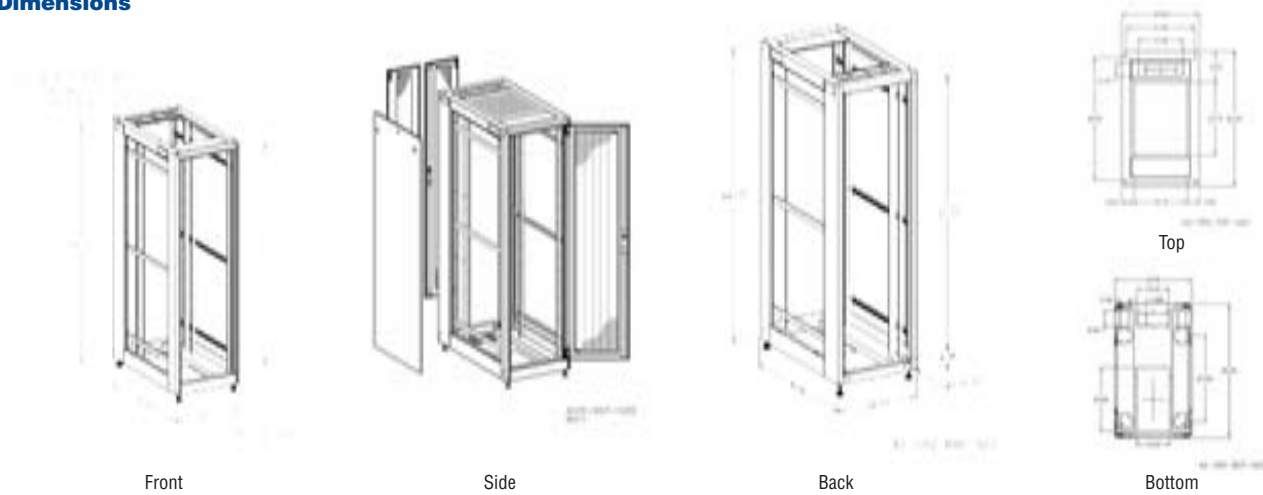

Technical Specifications

Enclosure Size	H	W	D	Weight	Mounting	Rack Spaces
BUSD84 Frame 3 pair 19" Mounting Rails, Casters, Levelers	84"	24"	42"	400 lb	19"	45U

EIA - 310 - D Compliant

Description	Belden Part Number
Ultra Deep 84" Black, 19" Mounting, 10" Fan Top, Front Rigid Perforated Door, Rear Split Perforated Door, Two Sides, 20 Amp Power Strip	BUSD84-3-122226
Ultra Deep 84" Black Frames w/19" Mounting	BUSD84-3-100000

How To Order

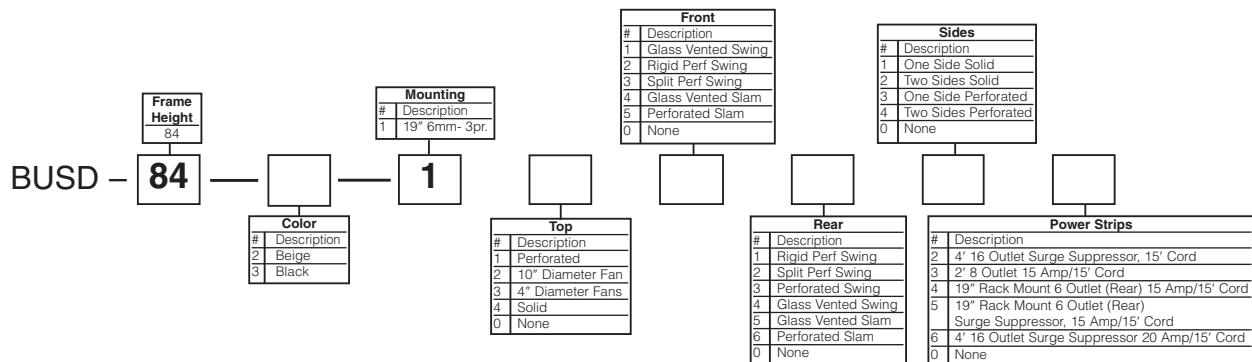

These products are in the process of being assessed for RoHS compliance. Please check our Web Site for the most current RoHS status.



For more information, contact Belden Technical Support: 1-800-BELDEN-1 • www.belden.com

Modular Enclosures

Ultra Deep Server Enclosure 24" Wide x 42" Deep (continued)

Tempered Glass Vented Doors



Perforated Doors



Side Panels

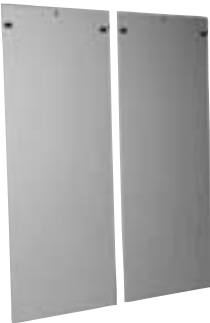

Description	Belden Part Number
Front Door	
Tempered Glass Front Door	
Tempered Glass Front (Vented) Door with Swing Handle, Latch and Lock	B8424-DSVF-C
Rigid Perforated Front Door	
Rigid Perforated Front Door with Swing Handle, Latch and Lock	B8424-DSPR-C
Rear Door	
Perforated Rear Door	
Split Door with Swing Handle, Latch and Lock	B8424-DSSR-C
Rigid Door with Swing Handle, Latch and Lock	B8424-DSPR-C
Door with Swing Handle, Latch and Lock	B8424-DSVR-C
Side Panels	
Single Side Panel	
1-Solid Lift-off Side Panel with Lock	B8436-01-SP-C
1-Perforated Lift-off Side Panel with Lock	B8436-01-SPP-C
Pair of Side Panels	
2-Solid Lift-off Side Panels with Lock	B8436-02-SP-C
2-Perforated Lift-off Side Panels with Lock	B8436-02-SPP-C
Removable Tops/Cooling Devices	
Solid Top	B2430-TP-1-C
Solid Top with 10" Diameter Fan, 550 CFM	B2430-TP-3-C
Solid Top with (4) 4" Diameter Fans, Four Fans = 320 CFM	B2430-TP-4-C
Perforated Top	B2430-TP-6-C
19" Fan Tray	B9315-7200
Cable Management Troughs	
76.5" Steel Vertical Cable Trough	B433-5114
Steel Front Horizontal Cable Trough	B433-5115-F
Steel Rear Horizontal Cable Trough	B433-5115-R
Steel Side Horizontal Cable Trough	B433-5118

These products are in the process of being assessed for RoHS compliance. Please check our Web Site for the most current RoHS status.

Solid Removable Top w/10" Fan



Solid Removable Top w/ (4) 4" Fans



19" Fan Tray



Modular Enclosures

Giga Server Enclosure

26" Wide x 42" Deep

BGS-Style Giga Server Enclosure



Giga Server Enclosure

The Giga Server is a freestanding enclosure with a 26" wide x 42" deep footprint. Each of the four corners of the enclosure has a built-in vertical cable channel. The unit's mounting rails have 19" EIA spacing to allow for cable management and different depths of equipment. Hinged cable access panels allow for large bundles of cable to be quickly routed from enclosure to enclosure or from the front of the enclosure to the rear of the enclosure. Among the many features and benefits of this modular unit are:

- **Reversible Door:** Spring-loaded hinges allow quick change of door swing.
- **Split Rear Doors:** French-style perforated rear doors maximize space between enclosures.
- **Lift-off Side Panels:** Flush surface lock fasteners permit quick disconnect lift off.
- **Door and Side Panel Security:** Doors and side panels lock; handles are flush mounted.
- **Integrated Cable Management.**
- **Grounding Kit included.**

Frames



BGS 84

These products are in the process of being assessed for RoHS compliance. Please check our Web Site for the most current RoHS status.

Modular Enclosures

Giga Server Enclosure
26" Wide x 42" Deep (continued)

Dimensions



Side

Technical Specifications

Enclosure Size	H	W	D	Weight	Mounting	Rack Spaces
BGS84 84" Frame, Three Pair 19" Mounting Rails, Casters, Levelers	84"	26"	42"	450 lb	19"	45U

Description	Belden Part Number
Giga Server 84" Black, 3-pair 19" Mounting, Perforated Top, Rigid Perforated Front, Split Fan Doors, Two Perforated Sides, 20 Amp Power Strip	BGS84-3-112346
Giga Server 84" Black, with 3-pair 19" Mounting	BGS84-3-100000

How To Order

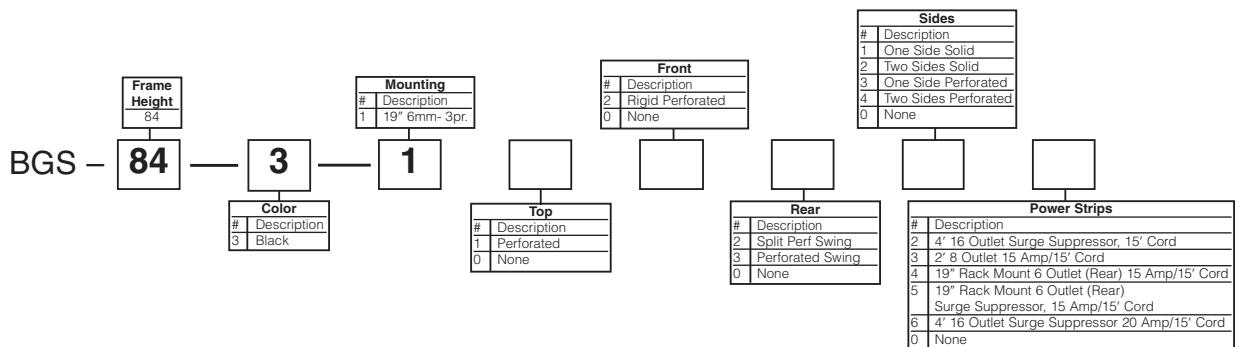

These products are in the process of being assessed for RoHS compliance. Please check our Web Site for the most current RoHS status.



For more information, contact Belden Technical Support: 1-800-BELDEN-1 • www.belden.com

Modular Enclosure Options and Accessories

Enclosure Shelves

B9010-1924

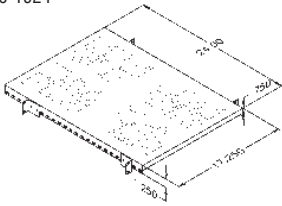

B9011-1918

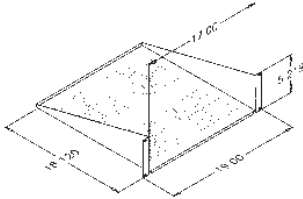

B9011-1918-16

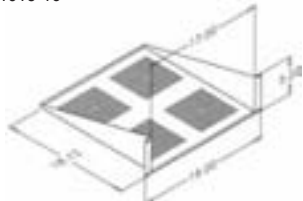

B9010-1930

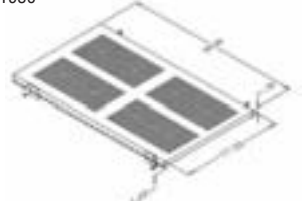

B9012-1918-16

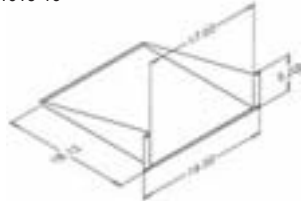

B9013-1936



B9012-1918

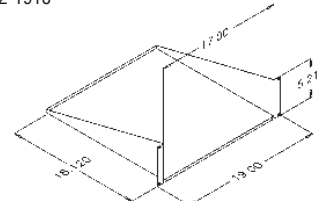

Enclosure Shelves

Modular Enclosure Shelves are available in widths of 19" and 23" with mounting depths of 24", 30" and 36". Load ratings range from 70 lbs up to 200 lbs. All shelves are black in color unless otherwise noted below.

Description	Belden Part Number
19" Shelves	
19" Heavy-Duty Adjustable Shelf (Vented)	
4 Point Mounting, 24" Depth, 150 lb Load Rating	B9010-1924
4 Point Mounting, 30" Depth, 150 lb Load Rating	B9010-1930
4 Point Mounting, 36" Depth, 150 lb Load Rating	B9010-1936
19" Flush Mount Cantilevered Shelf (Vented)	
12" Depth, Fits 24" Wall Mount, 70 lb Load Rating	B9011-1912
18" Depth, 75 lb Load Rating	B9011-1918
18" Depth, 50 lb Load Rating	B9011-1918-16
19" Flush Mount Cantilevered Shelf (Solid)	
18" Depth, 75 lb Load Rating	B9012-1918
18" Depth, 50 lb Load Rating	B9012-1918-16
19" Heavy Duty Sliding Adjustable Shelf (Vented)	
4 Point Mounting, 24" Depth, 200 lb Load Rating	B9015-1924
4 Point Mounting, 30" Depth, 100 lb Load Rating	B9013-1930
4 Point Mounting, 36" Depth, 100 lb Load Rating	B9013-1936
19" Keyboard Shelf (Fixed Front of Mounting Rail with Mouse Pad)	B9014-1907
19" Drawer, Monitor and Keyboard Shelf	B9015-1902
19" Sliding Rotating Keyboard Shelf	B9015-1909
19" Center Mount Shelf Kit (2-shelves)	
21" Depth, Aluminum, 100 lb Load Rating	B9016-1921
21" Depth, Black, 100 lb Load Rating	B9016-1921-3
19" Drawer, Utility, 4U, 16" Depth	B9017-0200
Pivot Cable Retractor	B9309-0100
19" Quick Disconnect Shelf	
6 mm Mounting Rails, 24" Depth, 200 lb Load Rating	B9010-1924-Q
6 mm Mounting Rails, 30" Depth, 200 lb Load Rating	B9010-1930-Q

These products are in the process of being assessed for RoHS compliance. Please check our Web Site for the most current RoHS status.

B9016-1921

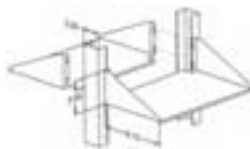

B9014-1907

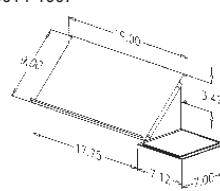

B9015-1909



B9010-1930-Q

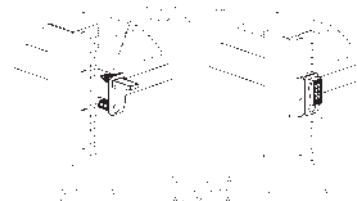

Modular Enclosure Options and Accessories

Enclosure Shelves (continued)

B9114-2307

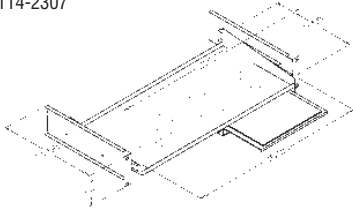

B9110-2324

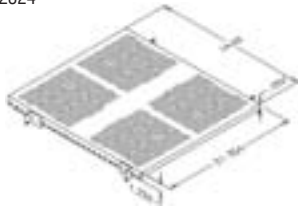

B9112-2318

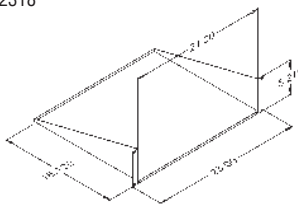

B9111-2318

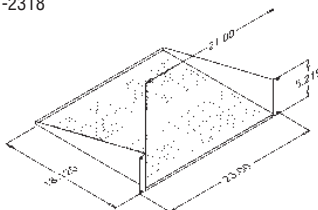

B9113-2324

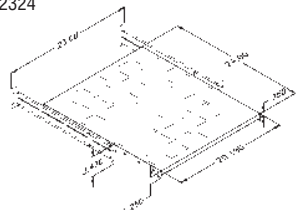

B9210-2923



B9212-2922

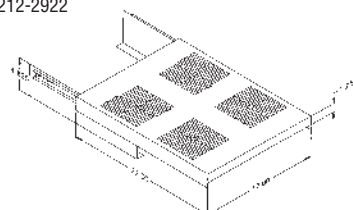

Description	Belden Part Number
23" Shelves	
23" Heavy Duty Adjustable Shelf (Vented) 4 Point Mounting, 180 lb Load Rating	B9110-2324
23" Flush Mount Cantilevered Shelf (Vented) 70 lb Load Rating	B9111-2318
23" Flush Mount Cantilevered Shelf (Solid) 70 lb Load Rating	B9112-2318
23" Heavy Duty Sliding Adjustable Shelf (Vented) 4 Point Mounting, 85 lb Load Rating	B9113-2324
23" Sliding Keyboard Shelf with Mouse Pad	B9114-2307

Frame Shelves

27.5" Wide Side Mount Shelf (Vented) 23.75" Depth, 180 lb Load Rating	B9210-2923
23.75" Depth, 90 lb Load Rating	B9211-2917
17" Wide Bottom Mount Sliding Server Shelf (Vented) 22" Depth, 100 lb Load Rating	B9212-2922

These products are in the process of being assessed for RoHS compliance. Please check our Web Site for the most current RoHS status.

B9211-2917

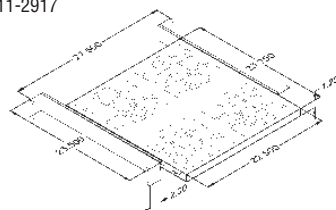

Modular Enclosure Options and Accessories

Anti-Tip, Grounding Bars, Mounting Hardware

BUS-ATD-0010



Enclosure Anti-Tip Device

The Data Standard, Data Slim, Data Deep and Ultra Deep Server Modular Enclosures are configured with an Anti-Tip Device which protects the enclosure from tipping when servers and shelves are extended.

Description	Belden Part Number
Anti-Tip Device for Ultra Deep Server	BUS-ATD-0010-C
Anti-Tip Device for Data Standard	BST-ATD-0030-3
Anti-Tip Device for Data Deep	BDP-ATD-0200-3
Anti-Tip Device for Data Slim	BSL/BST-ATD-0300-3

Grounding Bars

Copper grounding bars are available for mounting on any of the Enclosure types. Grounding bars are available for Vertical or Horizontal mounting.

Description	Belden Part Number
70" Vertical Isolated Copper Ground Bar, Tapped 10-32	B9714-0720
10" Horizontal Isolated Copper Ground Bar, Tapped 10-32	B9714-0190

B9714-0720



Enclosure Mounting Hardware

The Enclosure Mounting Hardware line includes a variety of bolts, screws and nuts for securing the enclosure.

Description	Belden Part Number
4, 5/16-18 Hex Head Bolt; 4, 5/16-18 Hex Nut; 8-5/16 Flat Washer	B8910-0100
10-32 Mounting Screws, Package of 50	B8911-0100
M6 Mounting Cagenut, Package of 50	B8913-0100
M6 Mounting Screw, Package of 50	B8914-0100
10-32 Mounting Hardware, 10-32 Floating Cagenut, Package of 50	B8915-0100

B9714-0190

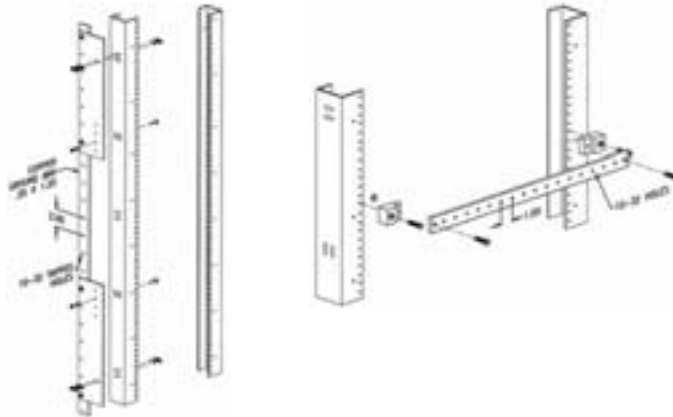

B8913-0100

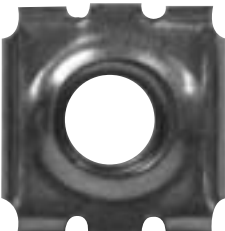

These products are in the process of being assessed for RoHS compliance. Please check our Web Site for the most current RoHS status.

Modular Enclosure Options and Accessories

Mounting Rails

Mounting Rails
Demonstrated in Enclosure



BRL-3024-0100



BRL-3012-0200



BRL-3006-0300



Enclosure Mounting Rails

The Enclosure Mounting Rail line includes 19" and 23" rails which are fully adjustable to accommodate different mounting depths.

Description	Belden Part Number
-------------	--------------------

Data Standard

Adjustable Mounting Rails 19" or 23"

Tapped 10-32, 48"	BST4819-23
Tapped 10-32, 72"	BST7219-23
Tapped 10-32, 78"	BST7819-23
Tapped 10-32, 84"	BST8419-23
6 mm with Hardware, 84"	BST8419-23SQ

Data Slim

Adjustable Mounting Rails 19" or 23"

Tapped 10-32, 72"	BSL7219
6 mm with Hardware, 72"	BSL7219SQ-2
Tapped 10-32, 78"	BSL7819
Tapped 10-32, 84"	BSL8419

Data Deep

Adjustable Mounting Rails 19" or 23"

Tapped 10-32, 72"	BDP7219-23
6 mm with Hardware, 72"	BDP7219-23SQ
Tapped 10-32, 78"	BDP7819-23
Tapped 10-32, 84"	BDP8419-23

Enclosure Partial Rail Kits

The Enclosure Partial Rail Kit line includes 6U, 12U and 24U rails for increased mounting flexibility.

Description	Belden Part Number
19" Partial Rail Kit (6U)	BRL-3006-0300
19" Partial Rail Kit (12U)	BRL-3012-0200
19" Partial Rail Kit (24U)	BRL-3024-0100

These products are in the process of being assessed for RoHS compliance. Please check our Web Site for the most current RoHS status.

Modular Enclosure Options and Accessories

Cable Management and Light Kits

B9713-0200

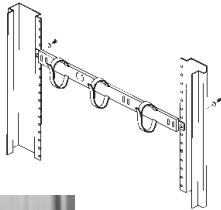

Horizontal: B9713-0200
Vertical: B9712-0100

Front to Rear Cable Management

Front to Rear Cable Management makes routing of cable neat, keeps them secure and manages bend radius.

Description	Belden Part Number
-------------	--------------------

Front to Rear Cable Management

w/3 Velcro Straps	B9713-0200
for 30" & 34" deep Enclosure 1" x 3" finger stock	B9713-0201
for 36" deep enclosure 1" x 3" finger stock	B9713-0202

Vertical Cable Management

Corner Mount Vertical Cable Management Ring 3" x 3" w/Velcro Strap	B9712-0100
Side Mount Cable Management 2.5" x 5.75"	B9712-0101
Front Mount Cable Management 1.5" x 3"	B9712-0102
1U Cable Manager 1" wide x 2" deep	B9712-0103
Mounting Rail Single M-Clip (XUSD)	B9712-0106
Mounting Rail Dual M-Clip (XUSD)	B9712-0107
Mounting Rail 84" Lacing Panel black (Data Standard, Data Slim, Data Deep)	B9712-0108
78" Lacing Panel black (Data Standard, Data Slim, Data Deep)	B9712-0109
78" Lacing Panel black (Ultra Server, Ultra Deep Server)	B9712-0109S

Light Kits

With dual adjustable 5 watt halogen lites & dimmer, UL Listed	B9420-1905
With single adjustable 5 watt halogen lite & dimmer, UL Listed	B9420-1906

These products are in the process of being assessed for RoHS compliance. Please check our Web Site for the most current RoHS status.

B9713-0201



B9713-0202



B9712-0100



B9712-0106



B9420-1905



B9712-0101

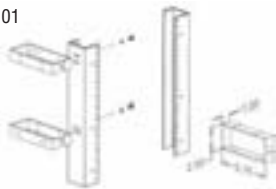

B9712-0108,
B9712-0109

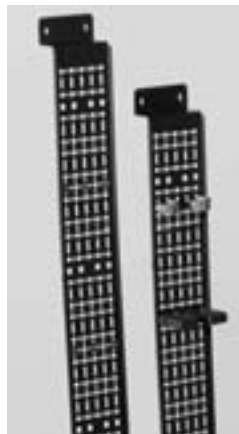

B9420-1906



B9712-0103

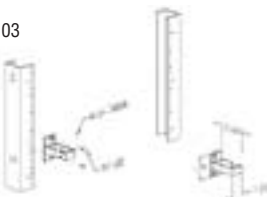

B9712-0102



B9712-0107



Modular Enclosure Options and Accessories

Enclosure Power Strips

Power Strips

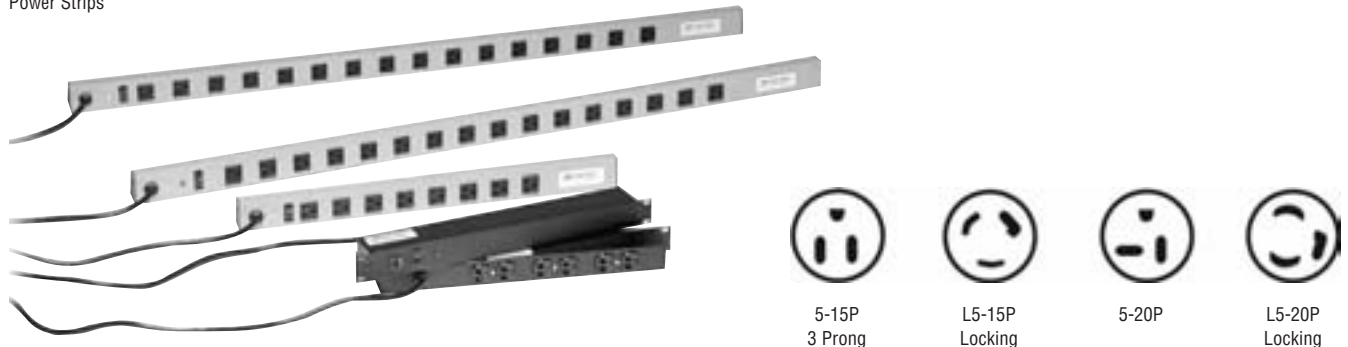

Technical Specifications

Part Number	Number of Outlets	Amps	Plug Type	Protection		Switch	Outlet Spacing	Volts	Receptacle Type	Cord Length
				Surge	Circuit					
B9411-1602	16	15	5-15P 3 Prong	Yes	Yes	Yes	2.500	120	5-15R	15 ft
B9412-0801	8	15	5-15P 3 Prong	No	Yes	Yes	2.000	125	5-15R	15 ft
B9413-0601	6	15	5-15P 3 Prong	No	Yes	Yes	1.50	125	5-15R	15 ft
B9414-0602	6	15	5-15P 3 Prong	Yes	Yes	Yes	1.50	125	5-15R	15 ft
B9415-1601	10	20	L5-20P Locking	No	Yes	Yes	4.300	120	5-15R	15 ft
B9415-1602	16	20	L5-20P Locking	No	Yes	Yes	2.500	120	5-15R	15 ft
B9415-1603	16	20	5-20P	No	Yes	Yes	2.430	120	5-15R	15 ft
B9415-1606	6	20	L5-20P Locking	No	Yes	Yes	2.650	120	5-15R	15 ft
B9415-1607	10	15	L5-15P Locking	No	Yes	Yes	4.25	120	5-15R	15 ft
B9415-1608	16	20	L5-20P Locking	No	No	No	2.735	120	5-15R	15 ft
B9415-1610	16	20	5-20P 3 Prong	Yes	Yes	No	2.25	125	5-20R	15 ft
B9416-1001	10	20	L5-20P Locking	No	Yes	Yes		120	5-15R	15 ft

Description	Belden Part Number
4' 16 Outlet Strip Surge Suppressor, 15' Power Cord, UL Listed	B9411-1602
2' 8 Outlet Strip, 15 Amp/15' Power Cord, UL Listed	B9412-0801
19" Rack Mount 6 Outlet Strip (Rear), 15 Amp/15' Power Cord, UL Listed	B9413-0601
19" Rack Mount 6 Outlet Strip (Rear) Surge, 15 Amp/15' Power Cord, UL Listed	B9414-0602
4' 10 Outlet Strip, 20 Amp/15' Power Cord w/Twist Lock Plug, UL Listed	B9415-1601
4' 16 Outlet Strip, 20 Amp/15' Power Cord w/Twist Lock Plug, UL Listed	B9415-1602
4' 16 Outlet Strip, 20 Amp/15' Power Cord, UL Listed	B9415-1603
6 Outlet Strip, 20 Amp/15' Power Cord w/Twist Lock Plug, UL Listed	B9415-1606
10 Outlet Strip, 15 Amp/15' Power Cord w/Twist Lock Plug, UL Listed	B9415-1607
4' 16 Outlet Strip, 20 Amp/15' Power Cord	B9415-1608
4' 16 Outlet Strip, 20 Amp Receptacle, Surge, CB, No Switch, 15' Cord, UL Listed	B9415-1610
19" Rack Mount 6 Outlet Front, 4 Outlet Rear, 20 Amp/15' Cord, w/Twist Lock Plug	B9416-1001

These products are in the process of being assessed for RoHS compliance. Please check our Web Site for the most current RoHS status.

Modular Enclosure Options and Accessories

Mission Critical Power Accessories

Mission Critical Power Accessory



Mission Critical Power Accessories

Slim-Line™ Low-Profile, Power Distribution, designed for high-density, mission critical server applications, the SL Series provides maximum power in a low profile chassis. Employing multiple configurations, the Easy-Read™ digital ammeter and clearly labeled circuits, SL Series assures easy management and monitoring for current requirements and future expansions.

- Datacenter grade receptacles
- 1.25" low profile
- Easy-Read digital ammeter

Dual-circuit, Vertical Power Distribution, designed for high-density, mission critical server applications, the DBVD Series provides dual-source in one vertical, power distribution unit. Employing multiple configurations, the Easy-Read digital ammeter and clearly labeled circuits, DBVD assures easy management and monitoring for current requirements and future expansions.

- High-density, dual source
- Side-by-side outlet configuration
- Easy-Read digital ammeter
- Clearly labeled circuits

Technical Specifications

Part Number	Circuit Type	Volts	Amps	Unit Length	Plug Type	Cord Length	Outlet Type	Qty.	Power (Watts)	Est. Server Qty.			Ammeter
										300W	400W	500W	
B9418-0801	Single	120	20	24"	Straight	15'	5-15/20	8	1920	10	8	6	Yes
B9418-0802	Single	120	20	24"	L5-20	15'	5-15/20	8	1920	10	8	6	Yes
B9418-1201	Single	120	20	60"	L5-20	15'	5-15/20	12	1920	10	8	6	Yes
B9418-2401	Single	120	30	60"	L5-30	15'	5-15/20	24	2880	15	12	9	No
B9418-2402	Dual	120	2 x 20	60"	2 x L5-20	15'	5-15/20	2 x 12	2 x 1920	10	8	6	No
B9418-2403	Dual	120	2 x 20	60"	L5-20	15'	5-15/20	2 x 12	2 x 1920	10	8	6	Yes
B9418-2410	Single	120	30	60"	L5-30	15'	5-15/20	24	2880	15	12	9	Yes
B9418-4801	Dual	208	2 x 30	68"	2 x L6-30	10'	C-13	2 x 24	2 x 4992	24	21	17	Yes
B9418-7201	Dual	208 3 phase	2 x 20	68"	2 x L21-20	10'	C-12	2 x 36	2 x 5757	32	24	19	Yes

Description	Belden Part Number
24" 8 Outlet 20 Amp Circuit, 120 Volt, Straight Plug, 15' Power Cord, with Ammeter, UL Listed	B9418-0801
24" 8 Outlet 20 Amp Circuit, 120 Volt, L-5 20 Plug, 15' Power Cord, with Ammeter, UL Listed	B9418-0802
60" 12 Outlet 20 Amp 120 Volt, L-5 20 Plug, 15' Power Cord with Ammeter, UL Listed	B9418-1201
60" 24 Outlet 30 Amp 120 Volt, L-5 30 Plug, 15' Power Cord, UL Listed	B9418-2401
60" Dual 12 Outlet, Dual 20 Amp Circuit, 120 Volt, Dual L-5 20 Plug, 15' Power Cord, UL Listed	B9418-2402
60" Dual 12 Outlet, Dual 20 Amp Circuit, 120 Volt, Single L-5 20 Plug, 15' Power Cord, with Ammeter, UL Listed	B9418-2403
60" 24 Outlet 30 Amp 120 Volt, L-5 30 Plug, 15' Power Cord, with Ammeter, UL Listed	B9418-2410
68" Dual 24 Outlet, Dual 30 Amp Circuit, Dual L-6 30 Plug, C-13 Outlets, 10' Power Cord, with Ammeter, UL Listed	B9418-4801
68" Dual 36 Outlet, Dual 20 Amp Circuit, Dual L-21 20 Plug, C-12 Outlets, 10' Power Cord, with Ammeter, UL Listed	B9418-7201

These products are in the process of being assessed for RoHS compliance. Please check our Web Site for the most current RoHS status.



Modular Enclosure Options and Accessories

Climate Monitors and Controllers

B9318-0400



Climate Monitor

Designed specifically for internal computer cabinet installation, this low-cost self-contained unit continually monitors climate via an internally-generated web page or SNMP. Values are graphed to see trends.

Its small size permits mounting in cabinet corners or the cabinet "attic" area and eliminates the environment monitor from occupying a 1-U space.

All software is contained inside the unit. The user supplies an Internet connection and an IP address. Administration of the unit is accomplished via the web page. When user-defined thresholds are exceeded, alarms can be sent via e-mail or SNMP trap.

A full set of internal sensors are included:

- Temperature
- Humidity
- Air Flow
- Light
- Sound

A variety of optional remote sensors are easily added. Up to 16 remote sensors can be added using Category 3 telephone wire and RJ-11 connectors. Remote sensors include:

- Web Cam
- Door Sensors
- Water Sensor
- Remote Temperature Sensor
- City Power Monitor
- In Line Power Monitoring

Remote sensors allow the unit to monitor up to 16 cabinets hundreds of feet apart and show the status of air-conditioning outputs. There is one remote RJ-11 sensor receptacle on the unit. Simple splitters are used to expand to use all 16 sensors.

Software protocols include:

- Web (HTTP)
- SMTP/POP
- SNMP (full MIB)
- FTP (firmware upgrades)
- Graphing
- PDA display format
- WAP (cell phone display)
- XML
- Excel™

The web cam used is an IP-based Axis 205; it can be installed locally or remotely.

Firmware updates can be made by FTP file transfer which eliminates retuning the unit to the factory.

B9318-0300



B9318-0200



Description	Belden Part Number
Climate monitor (Temperature, heat, humidity, airflow, sound)	B9318-0400

Electronic Fan Controller

- Remote temperature sensor with eight feet of cable allows mounting of controller in convenient location while precisely monitoring temperature at any point within the cabinet.
- Digital display shows actual temperature and programmed setpoint.
- Universal mounting bracket allows mounting to EIA rails or enclosure frame.
- Temperature range from -20°F (-29°C) to 140°F (60°C).

Description	Belden Part Number
Electronic Fan Controller	B9318-0300

Thermostat Fan Controller

- Low cost mechanical controller with Internal Bi-Metal sensing element.
- Position controller inside cabinet where temperature is to be monitored.
- Universal mounting bracket allows mounting to EIA rails or enclosure frame.
- Temperature range from -10°F (-23°C) to 100°F (38°C).

Description	Belden Part Number
Thermostat Fan Controller	B9318-0200

These products are in the process of being assessed for RoHS compliance. Please check our Web Site for the most current RoHS status.

Wall Mount Enclosures and Accessories

Wall Mount Enclosures

BWM 4820-GD



BWM 2406-SD



BWM 2420-SD

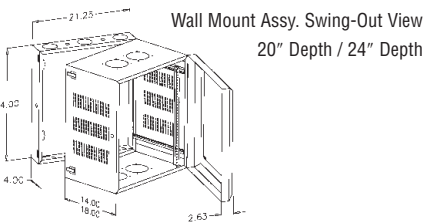

Wall Mount Assy. Swing-Out View
20" Depth / 24" Depth

Wall Mount Assy.
Rear Section
Mid Section
Front Door w/Glass

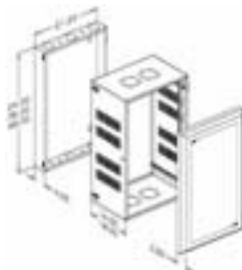

Wall Mount Assy. 4" Depth
Rear Section
Plywood Back Board (Opt.)
Front Door w/Glass

6" Depth

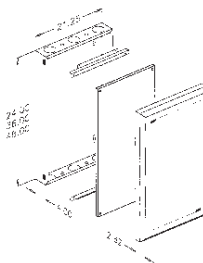

BWM-9312-1600 Fan Assembly
(2) 4" Diameter Fans (160 CFM) w/Guard



Wall Mount Enclosure

The Wall Mount Enclosure provides a secure and permanent location for a variety of components. Most units feature 19" mounting rails and are available with either a glass door with lock or a steel door with lock and 1 pair of 10-32 tapped rails. A 48" NEMA-12 model is also offered for harsh environments.

Description	Weight	Mounting	Belden Part Number
-------------	--------	----------	--------------------

Wall Mount Enclosure

24" Wall Mount Enclosure 6" Depth			
with Glass Door with Lock	40 lb	Back Board	BWM-2406-GD-C
with Steel Door with Lock	35 lb	Back Board	BWM-2406-SD-C
24" Wall Mount Enclosure 20" Depth			
with Glass Door with Lock	75 lb	12U	BWM-2420-GD-C
with Steel Door with Lock	70 lb	12U	BWM-2420-SD-C
24" Wall Mount Enclosure 24" Depth			
with Glass Door with Lock	80 lb	12U	BWM-2424-GD-C
with Steel Door with Lock	75 lb	12U	BWM-2424-SD-C
36" Wall Mount Enclosure 6" Depth			
with Glass Door with Lock	45 lb	Back Board	BWM-3606-GD-C
with Steel Door with Lock	45 lb	Back Board	BWM-3606-SD-C
36" Wall Mount Enclosure 20" Depth			
with Glass Door with Lock	90 lb	18U	BWM-3620-GD-C
with Steel Door with Lock	85 lb	18U	BWM-3620-SD-C
36" Wall Mount Enclosure 24" Depth			
with Glass Door with Lock	98 lb	18U	BWM-3624-GD-C
with Steel Door with Lock	95 lb	18U	BWM-3624-SD-C
48" Wall Mount Enclosure 6" Depth			
with Glass Door with Lock	75 lb	Back Board	BWM-4806-GD-C
with Steel Door with Lock	65 lb	Back Board	BWM-4806-SD-C
48" Wall Mount Enclosure 20" Depth			
with Glass Door with Lock	120 lb	25U	BWM-4820-GD-C
with Steel Door with Lock	110 lb	25U	BWM-4820-SD-C
48" Wall Mount Enclosure 24" Depth			
with Glass Door with Lock	135 lb	25U	BWM-4824-GD-C
with Steel Door with Lock	125 lb	25U	BWM-4824-SD-C
48" NEMA 12 Wall Mount Enclosure 24" Depth			
with Steel Door with Latch	205 lb	26U	BWM-4830-SD-3S0001

These products are in the process of being assessed for RoHS compliance. Please check our Web Site for the most current RoHS status.

NEMA 12

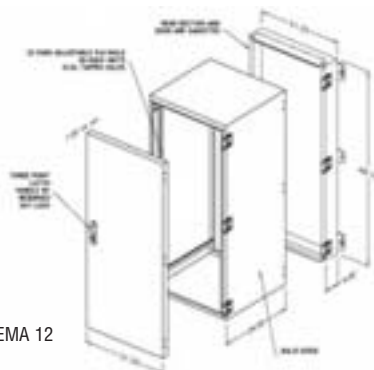

Wall Mount Enclosures and Accessories

Accessories and Swing Racks

Optional Basket

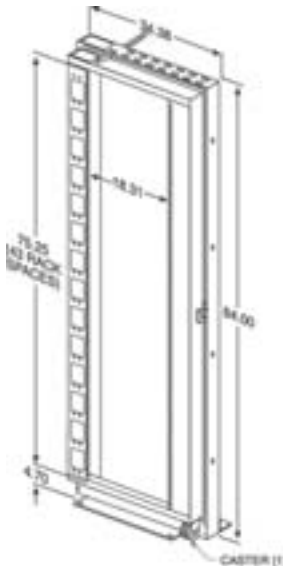

Wall Mount Enclosure Accessories

Description	Belden Part Number
Caster/Leveler Base	
Caster/Leveler Base, 20" or 24"	B8912-0200-C
Back Board	
24" Plywood Back Board (Black)	BWM-2401
36" Plywood Back Board (Black)	BWM-3601
48" Plywood Back Board (Black)	BWM-4801
Fan Assembly	
Fan Assembly (2) 4" Diameter Fans (160 CFM) with Guard	BWM-9312-1600
Mounting Uprights	
19" Mounting Uprights, 24"	BWM-2419
19" Mounting Uprights, 36"	BWM-3619
19" Mounting Uprights, 48"	BWM-4819

Swing Racks

The Swing Rack provides easy access to the rear of rack mounted equipment in a free-standing environment. It is ideal for applications where space is limited and rear access is essential.

Description	Weight	Mounting	Belden Part Number
84" Swing Out Distribution Rack	179 lb	34U	BSW-8419
Power Strip Mounting Kit (Sold Separately)			BSW-0100
Top Mounting Wire Basket (24" Long) (Sold Separately)			BSW-0200

Swing Racks

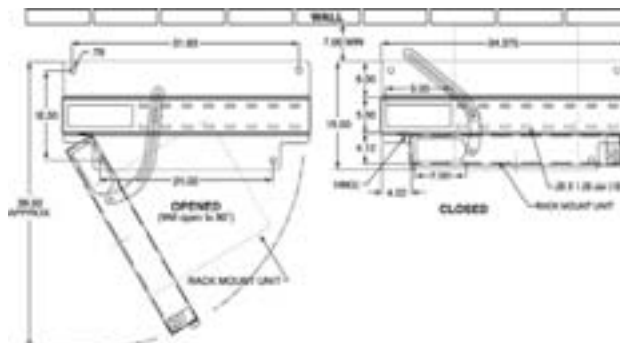

These products are in the process of being assessed for RoHS compliance. Please check our Web Site for the most current RoHS status.

Notes



Open Frame Racks and Accessories

12



Table of Contents

Open Frame Racks and Accessories	Page No.
Introduction	12.2
Open Frame Rack Kits & Accessories	12.3–12.4
Copper Rack Kit	12.3
Fiber Rack Kit	12.3
Floor Mount Rack	12.3
Distribution Racks	12.3
Vertical Cable Managers	12.3
Vertical Cable Management Channel	12.4
Horizontal Cable Management Channel	12.4
Cable Management Rack	12.4
Server Rack	12.4
Wall Mount Racks & Accessories	12.5
Accessories and Cable/Cord Management Units	12.6–12.7
Open Frame Rack Extender Brackets	12.6
Filler Panels	12.6
Patch Cord Organizers	12.6
Organizer Ring Panels	12.7
Organizer Trays	12.7
Brackets	12.7
Patch Cord Organizers	12.7
Cable Ties	12.8–12.10
Miniature: 18 Lbs Tensile Strength	12.8
Intermediate: 40 Lbs Tensile Strength	12.8
Standard: 50 Lbs Tensile Strength	12.8
Heavy Duty: 120 Lbs Tensile Strength	12.8
Heavy Duty: 175 Lbs Tensile Strength	12.9
Mount Ties	12.9
Marker Ties	12.9
Cable Tie Mounts	12.9
Velcro Cable Ties	12.10

Introduction

Belden: Resources Of a Higher Magnitude

Belden is the largest company of its kind, combining cable, connectivity, enclosures and many other product solutions for highly technical industries around the globe. As the exclusive occupant in this market position, Belden provides thousands of satisfied customers with over a billion dollars worth of trusted solutions every year, much of which supports the commercial networking sector. By combining our expertise in the design and manufacture of cable, connectivity, enclosures and related products, Belden now offers a product line of staggering magnitude, engineering triumphs and rich resources — worldwide.

Belden Open Frame Racks

The complete line of Belden Open Frame Racks are designed to meet the unique needs of data networks and other cabling systems. Whether it's the protection of sensitive equipment, the ability to mount equipment of varied sizes and depths, or the need to organize and neatly route installed cable, Belden has the solution you need. Belden provides you with single source convenience for all of your cable management requirements.

Enclosures and Racks

Choose from a variety of vertical enclosures, open frame racks and wall mount enclosures, all expertly engineered to optimize product quality and performance and manufactured in the United States for quick availability. Although standard configurations of the most popular enclosures are offered for fast delivery needs, all custom enclosures and racks have numerous mounting, cable and patch cord management options, along with a variety of accessories. This selection of Belden enclosures and racks will meet virtually any mounting, storage or protection requirement for your application.

Cable Ties

Belden cable ties are available in a complete variety of sizes for varying load capacities and are available in standard nylon or weather-resistant nylon.

Single Sourcing Convenience

The Cable Management product families in this catalog are offered to cabling professionals for ultimate convenience in single sourcing. As a Belden customer, you also have the assurance of total dependability by working with a market leader and a trusted partner who has a vested interest in optimizing your operations and investments. We want to make sure you not only get the products you need with ease, but they also perform reliably.

Cable Ties

Type	Tensile/Shear Strength	Length	Weather Resistant
Miniature	18 lbs.	4" or 8"	
Intermediate	40 lbs.	5 1/2" to 14 1/2"	●
Standard	50 lbs.	8" to 17 3/4"	●
Heavy Duty	120 lbs.	15"	
Heavy Duty	175 lbs.	17 3/4" to 48"	
Velcro	23 lbs./sq.in	8" or 12"	

Open Frame Racks

Type	Rack Space	Heights (inches)	Panel Mount (inches)	Width (inches)	Depth (inches)
Swing Rack	43U	84	19	34, 38	15
Distribution Rack	25, 39, 44U	48, 72, 84	19, 23	21.2, 25.2	21
Cable Management Rack	44U	84"	19	23.75, 25.75	15, 22
Copper Rack Kit	44U	84	19	30.75	14
Fiber Rack Kit	44U	84	19, 23	25, 29	14
Wall Mount Rack — Swing Out	19, 25U	36, 48	19	20	12 to 18
Wall Mount Rack — Hinged	2U, 4U, 6U	3.5, 7, 11	19	19, 19.5	4, 9.5



Open Frame Rack Kits & Accessories

Distribution Racks, Vertical Cable Managers

AX101174 Rack Kit



Open Frame Rack Kits

Rack Kits are offered for both copper and fiber cabling. Welded and knock-down rack assemblies are available for copper; knock-down rack kits are available for fiber. All units feature one rack with either one or two vertical and two horizontal channels.

Description	Mounting	Weight		Belden Part Number
		Lbs.	Kg	
Copper Rack Kit				
Welded Rack Assembly — Black, 19" x 84" (7') (One Rack w/ 2 Vertical & 2 Horizontal Channels)	44U	145	66	AX101174
Knock-Down Rack Assembly — Black, 19" x 84" (7') (One Rack w/ 2 Vertical & 2 Horizontal Channels)	44U	145	66	AX101175
Fiber Rack Kit				
Knock-Down Rack Assembly — Black, 19" x 84" (7') (One Rack with 1 Vertical & 2 Horizontal Channels)	44U	106	49	AX101176
Knock-Down Rack Assembly — Gray, 23" x 84" (7') (One Rack with 1 Vertical & 2 Horizontal Channels)	44U	113	52	AX101177
Floor Mount Rack				
Knock-Down Rack Assembly — Black, 19" x 84" (7') (w/ Two Horizontal Channels)	44U	65	30	AX101178
Knock-Down Rack Assembly — Gray, 19" x 84" (7') (w/ Two Horizontal Channels)	44U	65	30	AX101254
Knock-Down Rack Assembly — Black, 23" x 84" (7') (w/ Two Horizontal Channels)	44U	70	32	AX100931
Knock-Down Rack Assembly — Gray, 23" x 84" (7') (w/ Two Horizontal Channels)	44U	70	32	AX100930
Welded Rack Assembly — Black, 19" x 84" (7') (w/ Two Horizontal Channels)	44U	65	30	AX101179

BDR-Style Distribution Racks

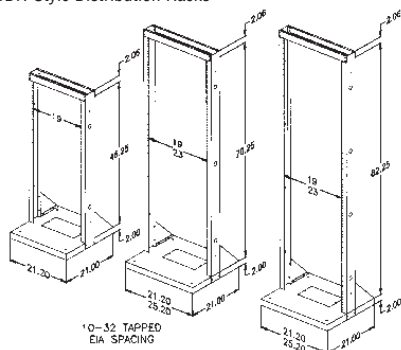

Distribution Racks

The Distribution Rack features 19" or 23" mounting rails for attaching a variety of rack mounted equipment. 48", 72" and 84" high models are included in the line.

Description	Mounting	Weight		Belden Part Number
		Lbs.	Kg	
48" Distribution Rack, 19" Mounting Rails	25U	34	15	BDR-4819
72" Distribution Rack, 19" Mounting Rails	39U	43	20	BDR-7219
84" Distribution Rack, 19" Mounting Rails	39U	50	23	BDR-8419
84" Distribution Rack, 19" Mounting Rails, 4" Channel with Angle Base, 12-24 EIA Spacing	45U	60	27	BDR-8419-4
72" Distribution Rack, 23" Mounting Rails	39U	45	20	BDR-7223
84" Distribution Rack, 23" Mounting Rails	45U	52	24	BDR-8423
Caster Kit for BDR Racks				B8912-0100

BDR-Style Vertical Cable Managers

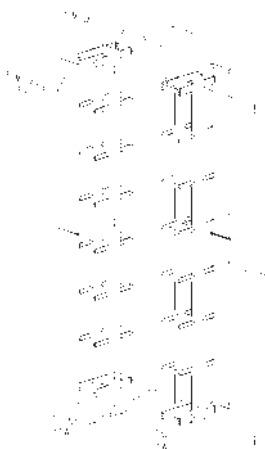

Vertical Cable Managers

The Vertical Cable Managers are used to manage patch cords in front and cables in the back. Available in 72" and 84" heights, the units are available with removable side panels and doors. They can be used with Distribution Racks (BDR-Style) and Rack Kit.

Description	Belden Part Number
72" Vertical Cable Manager	BDR-7201
84" Vertical Cable Manager	BDR-8401
84" Vertical Cable Manager, Double Sided with Cover	BDR-8403

These products are in the process of being assessed for RoHS compliance. Please check our Web Site for the most current RoHS status.



Open Frame Rack Kits & Accessories

Vertical and Horizontal Cable Management Channel, Cable Management Racks & Server Racks

AX101181 Horizontal Cable Management Channel



AX101180 Vertical Cable Management Channel



AX101371 Multi-Rack Attachment Spacer



Vertical Cable Management Channel

Vertical Cable Management Channels are offered for both copper and fiber cabling. Available in heights of 84", the channels make cable organization quick and easy, with Swing Out/Removable doors.

Description	Weight		Belden Part Number
	Lbs.	Kg	
Copper			
Knock-Down Assembly — Black, 5" x 84" (7')	40	18	AX101180
Fiber			
Knock-Down Assembly — Gray, 5" x 84"	35	16	AX100932
Knock-Down Assembly — Black, 5" X 84"	35	16	AX100933
Multi-Rack Attachment (Spacer) Kit Use between Two Fiber Vertical Managers (AX100932-933)			AX101371

Horizontal Cable Management Channel

Horizontal Cable Management Channels are available in widths of 19" and 23". The channels make cable organization quick and easy.

Description	Weight		Belden Part Number
	Lbs.	Kg	
19" Horizontal Cable Management Channel, Black	6	3	AX101181
19" Horizontal Cable Management Channel, Gray	6	3	AX101182
23" Horizontal Cable Management Channel, Black	8	4	AX101184
23" Horizontal Cable Management Channel, Gray	8	4	AX101183

BCR-8419 84" Cable Management Rack

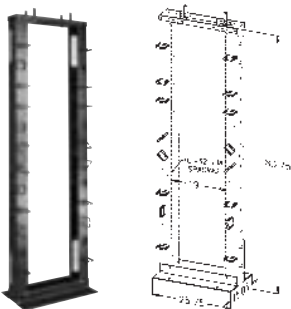

BCR-8419-10 84" Cable Management Rack w/ 10" Channel

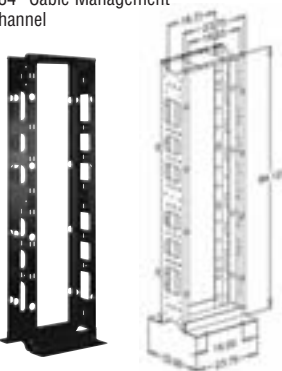

Cable Management Rack

The Cable Management Racks are designed for 19" rack-mount equipment and are 84" high. Model BCR-8419-10 features a channel that can be adjusted up to 10" deep.

Description	Mounting	Weight		Belden Part Number
		Lbs.	Kg	
84" Cable Management Rack, 19" Mounting Rails	45	53	24	BCR-8419
84" Cable Management Rack, 19" Mounting Rails, 10" Channel with Cable Management	45	60	27	BCR-8419-10

BSR-8419 Server Rack

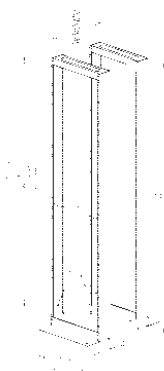

Server Rack

Server Racks are designed for either 19" or 23" rack-mount equipment and are 84" high. The Server Rack is available in depths of 24", 28" 32" and 36" to accommodate different equipment needs.

Description	Belden Part Number
84" Four Post Server Rack, 19" Mounting, Depth 24"	BSR-8419-24
84" Four Post Server Rack, 19" Mounting, Depth 28"	BSR-8419-28
84" Four Post Server Rack, 19" Mounting, Depth 32"	BSR-8419-32
84" Four Post Server Rack, 19" Mounting, Depth 36"	BSR-8419-36
84" Four Post Server Rack, 23" Mounting, Depth 24"	BSR-8423-24
84" Four Post Server Rack, 23" Mounting, Depth 28"	BSR-8423-28
84" Four Post Server Rack, 23" Mounting, Depth 32"	BSR-8423-32
84" Four Post Server Rack, 23" Mounting, Depth 36"	BSR-8423-36

These products are in the process of being assessed for RoHS compliance. Please check our Web Site for the most current RoHS status.



Wall Mount Racks & Accessories

BWR-3619

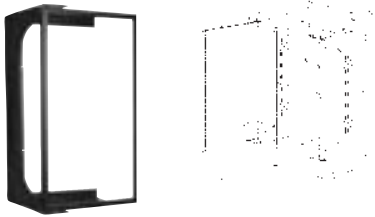

BWR-4819 — Swing out Distribution Racks
19" x 48" Depth Range 11.5" to 15.5"

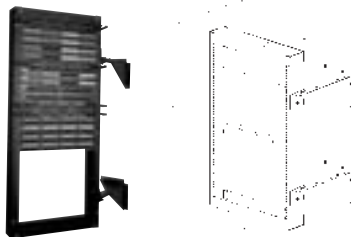

AX100785 Wall Mount Bracket, 2U



BWR-1219 — 12" Wall Mount Rack
Hinged mounting for easy access

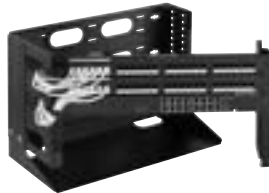

Adjustable shelf 2" - 6"



AX102514 — 4U Wall Mount Bracket w/2U Swivel



BER-6X6 — 6U Wall Mount Rack w/6U and 6U Front

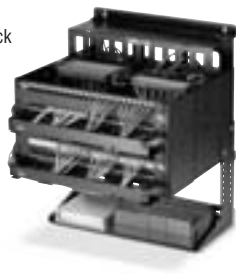

Wall Mount Racks

Wall Mount Racks are available in two styles: hinged and swing out. The hinged rack is 12" in height and features an adjustable lower shelf. The swing out rack is available in heights of 36" and 48" with 19" mounting rails. 2U, 4U and 6U Wall Mount Racks are also offered.

Description	Mounting	Weight		Belden Part Number
		Lbs.	Kg	
Swing Out Rack				
36" Wall Mount Swing Out Rack, 19" Mounting Rails x 12" Fixed Depth	18U	30	14	BWR-3619-12
36" Wall Mount Swing Out Rack, 19" Mounting Rails x 18" Depth	18U	30	14	BWR-3619-18
48" Wall Mount Swing Out Rack, 19" Mounting Rails, 11.5-15.5" Adjustable Depth	25U	39	18	BWR-4819
48" Wall Mount Swing Out Rack, 19" Mounting Rails x 12" Fixed Depth	25U	39	18	BWR-4819-12
48" Mount Swing Out Rack, 19" Mounting Rails x 18" Depth	25U	39	18	BWR-4819-18
Hinged Rack				
12" Wall Mount Rack, Hinged 19" Mounting Rails x 9" Fixed Depth	6U	26	12	BWR-1219
Wall Mount Bracket				
2U Wall Mount Bracket, Black	2U	4	2	AX100785
4U Wall Mount Bracket, Black	4U	8	4	AX100786
4U Wall Mount Bracket w/ 2U Swivel				AX102514
6U Wall Mount Rack				
6U Wall Mount Rack with 6U Top and 6U Front Rack Space, Tapped 12-24 EIA	6"	17	8	BER-6X6
Bottom Accessory Shelf				BER-AS
Front Mounted Swing-out Patch Panel Kit, 6U				BER-6UP
Single, 3U Space Top Dust Cover				BER-3UC

These products are in the process of being assessed for RoHS compliance. Please check our Web Site for the most current RoHS status.

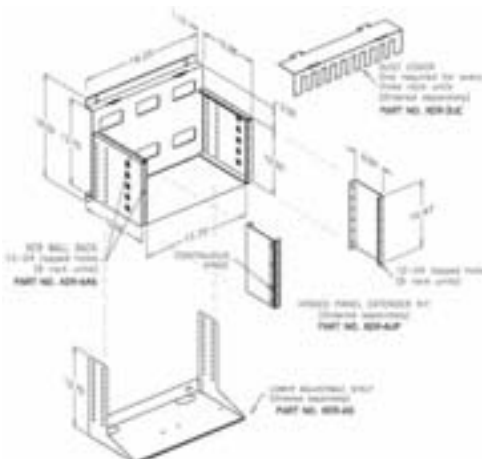

Open Frame Rack Accessories & Cable/Cord Management Units

Extender Brackets, Filler Panels, Patch Cord Organizers

Rack Extenders



19" Filler Panels

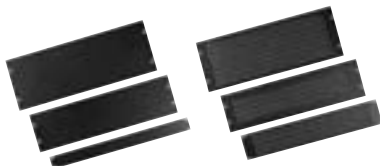

B9511-1902

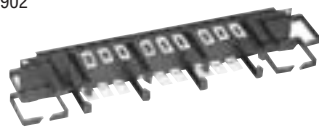

B9510-1901



B9512-1901



Top: B9512-1902
Bottom: B9512-1902



Open Frame Rack Extender Brackets

The Open Frame Rack Extender Brackets are used to extend a 19" Panel/Equipment Mounting for 23".

Description	Belden Part Number
1U 23" EIA To 19" EIA Extender Bracket	B9810-0100
2U 23" EIA To 19" EIA Extender Bracket	B9811-0200
3U 23" EIA To 19" EIA Extender Bracket	B9812-0300
4U 23" EIA To 19" EIA Extender Bracket	B9813-0400

Filler Panels

Filler Panels are available in solid or vented for improved air flow.

Description	Belden Part Number
1U 19" Solid Filler Panel, Gray	A0644497
2U 19" Solid Filler Panel, Gray	A0644499
1U 19" Solid Filler Panel, Black	B9910-0100
2U 19" Solid Filler Panel, Black	B9911-0200
3U 19" Solid Filler Panel, Black	B9912-0300
4U 19" Solid Filler Panel, Black	B9913-0400
2U 19" Vented Filler Panel, Black	B9914-0200
3U 19" Vented Filler Panel, Black	B9915-0300
4U 19" Vented Filler Panel, Black	B9916-0400

Patch Cord Organizers

The Patch Cord Organizers keep wires and cable under control. Among the many features of the Patch Cord Organizers are:

- Horizontal / Vertical Patch Cord Management
- Front / Rear Management
- Removable Covers
- Bend Radius Control

Description	Belden Part Number
1U 19" Cable Organizer	B9510-1901
2U 19" Cable Organizer with Saddle Rings	B9511-1902
1U 19" Rack Mount Cable Organizer with Finger Stock and Cover (1.5" x 2")	B9512-1901
2U 19" Rack Mount Cable Organizer with Finger Stock and Cover (3" x 3")	B9512-1902
2U 19" Cable Organizer with Finger Stock and Cover Front and Rear	B9512-1902-FR
2U 19" Cable Organizer with Quick Touch (2" X 3")	B9513-1902
1U 19" Cable Organizer with Radius (Waterfall)	B9514-1901
1U 23" Cable Organizer	B9610-2301
2U 23" Cable Organizer with Saddle Rings	B9611-2302

These products are in the process of being assessed for RoHS compliance. Please check our Web Site for the most current RoHS status.



Open Frame Rack Accessories & Cable/Cord Management Units

Ring Panels, Organizer Trays, Brackets & Patch Cord Channel

AX100249 Organizer Tray, 3U



AX100463 Rear Cable Bracket

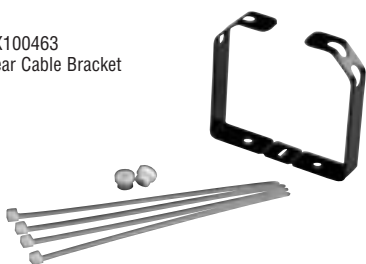

AX101173 Cable Tie Bar



AX100789 Cable Support Bracket

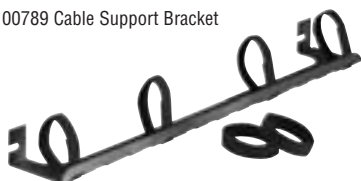

AX100793 Patch Cord Organizer Channel



A0396695 Organizer Ring Panel, 2U



A0644488 Organizer Panel, 1U



Open Frame Rack Cable and Patch Cord Management

The Open Frame Rack Cable and Patch Cord Management accessories can be used with patch panels in open frame racks for distribution cable and patch cord organization, routing and protection. They allow easier cord access and simplify moves, additions and changes.

Description	Mounting	Belden Part Number
Organizer Ring Panel, Gray	2U	A0396695
Organizer Ring Panel, Black	2U	A0403977
Organizer Panel, Gray	1U	A0644488
Organizer Panel, Black	1U	A0644489
Organizer Panel, Gray	2U	A0644490
Organizer Panel, Black	2U	A0644492
Organizer Tray, Gray	3U	AX100248
Organizer Tray, Black	3U	AX100249
Rear Cable Bracket, Gray		AX100462
Rear Cable Bracket, Black		AX100463
Cable Support Bracket, Gray	0U	AX100788
Cable Support Bracket, Black	0U	AX100789
Patch Cord Organizer Channel, Gray	1U	AX100792
Patch Cord Organizer Channel, Black	1U	AX100793
Patch Cord Organizer Channel, Gray	2U	AX100794
Patch Cord Organizer Channel, Black	2U	AX100795
Patch Cord Organizer Channel, Gray	4U	AX100796
Patch Cord Organizer Channel, Black	4U	AX100797
Cable Tie Bar, Black	0U	AX101173

These products are in the process of being assessed for RoHS compliance. Please check our Web Site for the most current RoHS status.

Cable Ties

Miniature, Intermediate, Standard & Heavy-Duty

CTM4018N
Cable Ties



CTM4018B
Cable Ties



Cable Ties

The Cable Ties line features miniature, intermediate, standard and heavy duty cable ties. They are available in tensile strengths ranging from 18 to 175 lbs. and are manufactured from various grades of nylon including weather-resistant nylon for use in sunshine/outdoor applications. They are offered in lengths from 4" to 48". Color: Natural (indoor), Black (outdoor). Velcro Cable Ties are also available.

Description	Length		Width		Loop Tensile Strength		Max. Bundled Diameter		Belden Part No.
	in.	mm	in.	mm	Lbs.	N	in.	mm	
Miniature 18 Lbs Tensile Strength									
Nylon Cable Tie, 100 Pcs, Natural, 4"	3.9	100	0.098	2.5	18	80	1.0	25	CTM4018N
Nylon Cable Tie, 100 Pcs, Natural, 5.5"	5.6	142	0.098	2.5	18	80	1.4	35	CTM5P18N
Nylon Cable Tie, 100 Pcs, Natural, 8"	8.0	203	0.098	2.5	18	80	2.2	55	CTM8018N
Intermediate 40 Lbs Tensile Strength									
Nylon Cable Tie, 100 Pcs, Natural, 5.5"	5.6	142	0.125	3.2	40	178	1.4	35	CTI5P40N
Nylon Cable Tie, 100 Pcs, Natural, 8"	8.0	203	0.141	3.6	40	178	2.2	55	CTI8040N
Nylon Cable Tie, 100 Pcs, Natural, 11"	11.5	292	0.141	3.6	40	178	3.3	85	CTI11P40N
Nylon Cable Tie, 100 Pcs, Natural, 14.5"	14.5	368	0.141	3.6	40	178	4.0	103	CTI14P40N
Weather Resistant Nylon Cable Tie, 100 Pcs, Black, 5.5"	5.6	142	0.125	3.2	40	178	1.4	35	CTI5P40BW
Weather Resistant Nylon Cable Tie, 100 Pcs, Black, 8"	8.0	203	0.141	3.6	40	178	2.2	55	CTI8040BW
Weather Resistant Nylon Cable Tie, 100 Pcs, Black, 11.5"	11.5	292	0.141	3.6	40	178	3.3	85	CTI11P40BW
Weather Resistant Nylon Cable Tie, 100 Pcs, Black, 14.5"	14.5	368	0.141	3.6	40	178	4.0	103	CTI14P40BW
Standard 50 Lbs Tensile Strength									
Nylon Cable Tie, 100 Pcs, Natural, 8"	8.0	203	0.180	4.6	50	222	2.2	55	CTS8050N
Nylon Cable Tie, 100 Pcs, Natural, 11"	11.0	280	0.188	4.8	50	222	3.2	81	CTS1150N
Nylon Cable Tie, 100 Pcs, Natural, 14.5"	14.5	368	0.188	4.8	50	222	4.0	103	CTS14P50N
Nylon Cable Tie, 100 Pcs, Natural, 17.75"	17.7	450	0.188	4.8	50	222	5.1	131	CTS17P50N
Weather Resistant Nylon Cable Tie, 100 Pcs, Black, 8"	8.0	203	0.180	4.6	50	222	2.2	55	CTS8050BW
Weather Resistant Nylon Cable Tie, 100 Pcs, Black, 11.5"	11.0	280	0.188	4.8	50	222	3.2	81	CTS1150BW
Weather Resistant Nylon Cable Tie, 100 Pcs, Black, 14.5"	14.5	368	0.188	4.8	50	222	4.0	103	CTS14P50BW
Weather Resistant Nylon Cable Tie, 100 Pcs, Black, 17.75"	17.7	450	0.188	4.8	50	222	5.1	131	CTS17P50BW
Heavy Duty 120 Lbs Tensile Strength									
Nylon Cable Tie, 100 Pcs, Natural, 15"	15.0	380	0.298	7.6	120	533	4.3	111	CTH15120N

These products are in the process of being assessed for RoHS compliance. Please check our Web Site for the most current RoHS status.

Cable Ties

Marker Ties, Cable Tie Mounts

Marker Ties

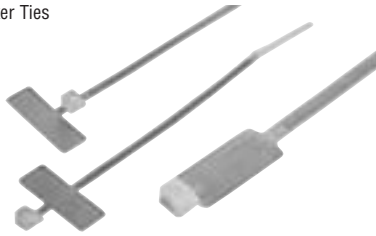

Description	Length		Width		Loop Tensile Strength		Max. Bundled Diameter		Belden Part No.
	in.	mm	in.	mm	Lbs.	N	in.	mm	
Heavy Duty Nylon Cable Tie (175 Lbs Tensile Strength)									
100 pcs, Natural, 17.75"	17.7	450	0.313	8.0	175	778	5.2	134	CTH17P175N
100 pcs, Natural, 21.7"	21.7	550	0.313	8.0	175	778	6.5	167	CTH21P175N
100 pcs, Natural, 36"	36.0	914	0.352	9.0	175	778	10.6	271	CTH36P175N
100 pcs, Natural, 48"	48.0	1219	0.352	9.0	175	778	15.0	382	CTH48P175N
Mount Ties									
100 pcs, Natural, 40 lb, 6"	6.7	171	0.145	3.7	40	178	1.6	40	CTI6040NM
100 pcs, Natural, 50 lb, 11.75"	11.8	300	0.188	4.8	50	222	3.3	85	CTS11P50NM
100 pcs, Natural, 50 lb, 14.5"	14.6	370	0.188	4.8	50	222	4.0	103	CTS14P50NM

Cable Tie Mounts

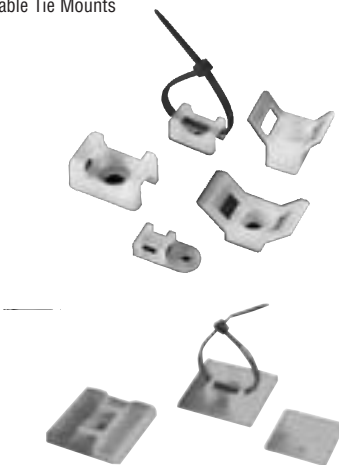

Description	Length		Width		Loop Tensile Strength		Max. Bundled Diameter		Marking Pad		Belden Part No.
	in.	mm	in.	mm	Lbs.	N	in.	mm	in.	mm	
Marker Ties (18 Lbs Tensile Strength)											
100 pcs, Natural, 4"	3.9	100	0.098	2.5	18	80	1.0	25	0.98 x 0.31	25 x 8	CTM4018NMK
100 pcs, Natural, 4.25"	4.3	110	0.098	2.5	18	80	1.0	25	0.98 x 0.32	26 x 8	CTM4P18NMK
100 pcs, Natural, 5"	5.1	130	0.098	2.5	18	80	1.0	25	1.10 x 0.79	28 x 20	CTM5018NMK
100 pcs, Natural, 8"	7.9	200	0.098	2.5	18	80	2.0	50	1.18 x 0.59	30 x 15	CTM8018NMK
Marker Ties (50 Lbs Tensile Strength)											
100 pcs, Natural, 8"	7.9	200	0.180	4.6	50	222	2.0	50	1.10 x 0.51	28 x 13	CTS8050NMK
100 pcs, Natural, 10.5"	10.6	270	0.180	4.6	50	222	3.0	75	1.10 x 0.51	28 x 13	CTS10P50NMK

Mount Ties

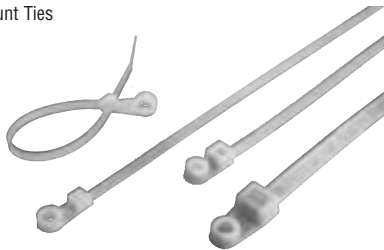

Description	Length		Width		Mounting Method	Belden Part No.
	in.	mm	in.	mm		
Cable Tie Mounts						
Cable Tie Mount S.A. M, 100 per bag	0.49	12.5	0.49	12.5	Self Adhesive	TM100S4
Cable Tie Mount S.A. M-I, 100 per bag	0.75	19.0	0.74	19.0	#4 M2.5 Screw + Self Adhesive	TM101SS2
Cable Tie Mount S.A. M-I-S, 100 per bag	1.10	28.0	1.10	28.0	#4 M2.5 Screw + Self Adhesive	TM102
Cable Tie Mount Sc. M-I, 100 per bag	0.50	12.8	0.27	7.0	#4 M2.5 Screw	TM1
Cable Tie Mount Sc. I-S-HD, 100 per bag	0.91	23.0	0.63	16.0	1/4 M6 Screw	TM2
Cable Tie Mount Sc. I-S-HD, 100 per bag	1.18	30.0	0.58	14.7	#10 M5 Screw	TM4

Cable mounts compatible with following cable tie cross section.

- S.A. = Self Adhesive
- M = Miniature
- Sc. = Screw on type
- I = Intermediate
- S = Standard
- HD = Heavy Duty

These products are in the process of being assessed for RoHS compliance. Please check our Web Site for the most current RoHS status.



For more information, contact Belden Technical Support: 1-800-BELDEN-1 • www.belden.com

Cable Ties

Velcro Ties, Saddles, Saddle Ties

AX100781
Velcro Saddle



AX102512
Saddle Tie

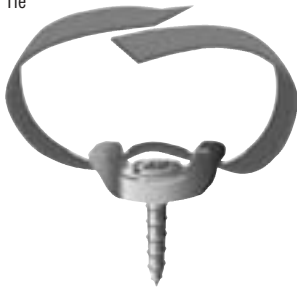

AX102516
12" Fiber Optic Cable Manager



Description	Belden Part Number
Velcro Cable Ties	
Velcro Cable Ties, 25 per Roll, 8"	AX100783
Velcro Cable Ties, 25 per Roll, 12"	AX100784
Velcro Saddle, 25 pcs	AX100781
Velcro Saddle Kit with #8 Wood Screw, 10 pcs	AX102512
Velcro Saddle Kit with 10/32 Rack Screw, 10 pcs	AX102513
15' Roll x 5/8" Polywrap, Cut to length as required	AX102515
12" Fiber Optic Cable Manager	AX102516
24" Fiber Optic Cable Manager	AX102517

These products are in the process of being assessed for RoHS compliance. Please check our Web Site for the most current RoHS status.



Surface Raceway Systems

Table of Contents

Surface Raceway Systems	Page No.
One-Piece Latching Raceway	13.2
Surface Raceway System Accessories	13.3
Ceiling Entries	13.3
Corners: <i>Inside and Outside</i>	13.3
Elbows: <i>Flat and High-Radius</i>	13.3
End Caps	13.3
Splice Covers	13.3
Tees: <i>3-Way and 4-Way</i>	13.3
Surface Raceway System Adapter Boxes	13.3
MediaFlex Single Gang	13.3
MediaFlex Double Gang	13.3
Technical Information	13.4
Raceway Fill Capacity Chart	13.4

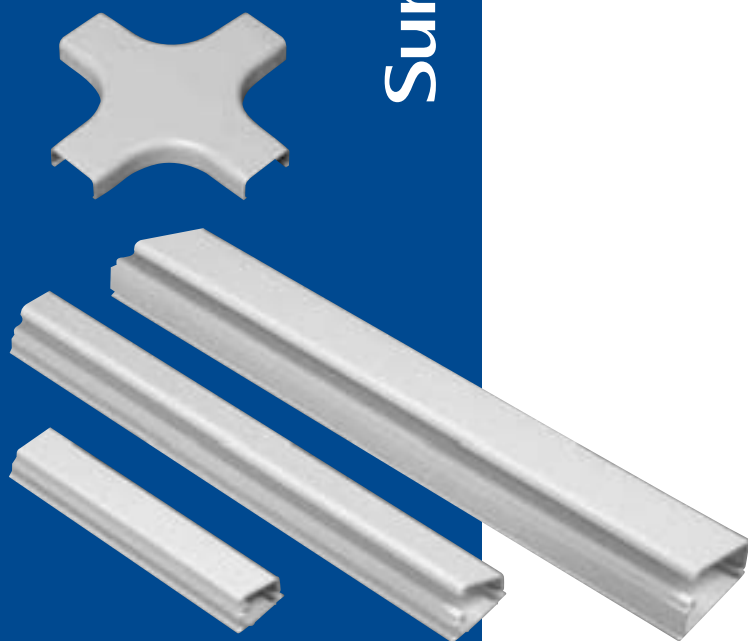

One-Piece Latching Raceway

BFT-Style Surface Raceway Systems



Surface Raceway System

The Surface Raceway System is a functional, affordable, attractive solution for wire enclosure applications in commercial, industrial and residential environments. The product line includes extruded raceways with pre-applied adhesive backings, fittings, and Adapter Boxes.

- One piece design features patented hinge (Lid can be opened in any mounting position.)
- Parts are made of a strong, durable, lightweight, UL 94-V0 compliant PVC
- UL 5A specification for 600 volt applications
- One inch minimum bend radius accessories available for Category 5e, 6 and fiber optic installations
- All products are fully paintable

Available in three sizes:

- 3/4" x 1/2" (Model No. 03SR)
- 1" x 1/2" (Model No. 05SR)
- 1-1/2" x 3/4" (Model No. 09SR)



Description	Dimensions (mm)				Belden Part Number
	A	B	C	Tape Width	
One-Piece Latching Raceway					
03SR White, 3/4" x 1/2" 8 ft, 20 pcs	0.760" (19.3)	0.505" (12.8)	0.050" (1.27)	0.500" (12.7)	BFT-03SRW8
05SR White, 1" x 1/2" 8 ft, 20 pcs	1.010" (25.7)	0.505" (12.8)	0.050" (1.27)	0.750" (19.1)	BFT-05SRW8
09SR White, 1-1/2" x 3/4" 8 ft, 20 pcs	1.500" (38.1)	0.755" (19.2)	0.050" (1.27)	1.000" (25.4)	BFT-09SRW8

These products are in the process of being assessed for RoHS compliance. Please check our Web Site for the most current RoHS status.

Area of Raceway

Model No.	Sq. In.	mm ²
03SR	0.259	167.10
05SR	0.488	314.84
09SR	0.827	533.55

See chart on page 13.4 for Raceway fill capacities.

Accessories & Adapter Boxes

BFT-CE03W Ceiling Entry



BFT-EC03W End Cap

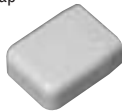

BFT-F003W High Radius Elbow



BFT-9003W Flat Elbow



BFT-IN30W Inside Corner



BFT-OC03W Outside Corner



BFT-SC03W Splice Cover

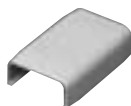

BFT-3T03W 3-Way Tee



BFT-4T03W 4-Way Tee



AX102610 MediaFlex Double Gang Adapter Box



Surface Raceway System Accessories

A wide variety of accessories are available for the Surface Raceway System including:

- Ceiling Entries
- End Caps (End cap doubles as reducer to all three raceway sizes)
- High radius elbows
- Flat Elbows
- Inside Corners
- Splice Covers
- Outside Corners
- 3-Way and 4-Way Tees

Description	Belden Part Number		
	03SR	05SR	09SR

Surface Raceway Accessories			
Ceiling Entry, White, 10 pcs	BFT-CE03W	BFT-CE05W	BFT-CE09W
Splice Cover, White, 10 pcs	BFT-SC03W	BFT-SC05W	BFT-SC09W
End Cap, White, 10 pcs	BFT-EC03W	BFT-EC05W	BFT-EC09W
3-Way Tee, White, 10 pcs	BFT-3T03W	BFT-3T05W	BFT-3T09W
Flat 90 Elbow, White, 10 pcs	BFT-9003W	BFT-9005W	BFT-9009W
Inside Corner, White, 10 pcs	BFT-IN03W	BFT-IN05W	BFT-IN09W
Outside Corner, White, 10 pcs	BFT-OC03W	BFT-OC05W	BFT-OC09W
4-Way Tee, White, 10 pcs	BFT-4T03W	BFT-4T05W	BFT-4T09W
High Radius Elbow, White, 10 pcs	BFT-F003W	BFT-F005W	BFT-F009W

These products are in the process of being assessed for RoHS compliance. Please check our Web Site for the most current RoHS status.

Surface Raceway System Adapter Boxes

MediaFlex Surface Adapter Boxes are one part of the comprehensive line of plates and inserts that snap together to create a full line of modular workstation outlets. MediaFlex Surface Adapter Boxes are designed to work with Belden surface raceway systems. The MediaFlex Surface Adapter Boxes are available in Single and Double Gang configuration.

- Good depth allow more room for cable management and bend radius
- Comes with mounting plate for added installation flexibility
- No special tools required, therefore reduces installation time
- Sturdy design for excellent durability and network protection
- Modern unique aesthetic design

Description	Belden Part Number
-------------	--------------------

Adapter Boxes	
MediaFlex Single Gang Adapter Box, Standard, White	AX102611
MediaFlex Double Gang Adapter Box, Standard, White	AX102610

These products are in the process of being assessed for RoHS compliance. Please check our Web Site for the most current RoHS status.

Technical Information

Raceway Fill Capacity Chart

Wire Type	Wire Diameter		Wire Area		Number of Cables per Raceway		
	Inch	mm	Sq. In.	mm ²	03SR	05SR	09SR
Building Wire THHN							
14 AWG	0.108	2.74	0.0092	5.935	3	5	9
12 AWG	0.126	3.20	0.0125	8.065	2	4	7
10 AWG	0.170	4.32	0.0227	14.645	1	2	4
Signal Wire UL Style 1061 • 300V 80 C°*							
18 AWG	0.066	2.74	0.0034	2.194	30	57	97
20 AWG	0.066	1.68	0.0028	1.806	37	69	117
22 AWG	0.050	1.27	0.0020	1.290	53	99	169
24 AWG	0.045	1.14	0.0016	1.032	65	123	208
Unshielded Twisted Pair Wire (UTP) 24 AWG*							
2-Pair	0.140	3.56	0.0154	9.935	7	13	22
3-Pair	0.150	3.81	0.0177	11.419	6	11	19
4-Pair Cat 5e, Cat 6	0.220	5.59	0.0380	24.516	3	5	9
25-Pair	0.510	12.95	0.2042	131.742	0	1	2
Twisted Pair Wire (Shielding)*							
4-Pair 24 AWG	0.250	6.35	0.0491	31.677	2	4	7
25-Pair 24 AWG	0.510	12.95	0.2042	131.742	0	1	2
Type 1A 22 AWG	0.430	10.92	0.1451	93.613	1	1	2
Coax Cable (Max.)							
RG-58/U	0.193	4.90	0.0292	18.839	4	7	11
RG-59/U, RG-62/U	0.242	6.15	0.0460	29.677	2	4	7
RG-6/U	0.270	6.86	0.0572	36.903	2	3	6
Fiber Optic Cable 62.5/125/900, PVC JACKET, OFNR*							
2 Strand	0.175	4.45	0.0240	15.484	4	8	14
4 Strand	0.185	4.70	0.0269	17.355	4	7	12
6 Strand	0.210	5.33	0.0346	22.323	3	6	10

*Based on 40% fill ratio

Area of Raceway

Model No.	Sq. In.	mm ²
03SR	0.259	167.10
05SR	0.488	314.84
09SR	0.827	533.55



PowerSense® PoE Products

14

Table of Contents

PowerSense® PoE Products	Page No.
Introduction	14.2
Power Over Ethernet Midspan Hubs	14.3–14.5
PowerSense AX-8000 Series: Modular Multiport	14.3
PowerSense AX-8000 Series: Single-port	14.4
PowerSense AX-6000 Series: 24-port, 8-Port Module	14.5
Power Over Ethernet Accessories	14.6
PoE Connectors	14.6
Data & Power Splitting “Y” Cables	14.6



Introduction

Delivering Power over Ethernet (PoE) to the Enterprise

Consistent with Belden’s commitment to quality and innovation, we offer PowerSense™ high-performance power distribution equipment for the efficient and reliable delivery of Power over Ethernet.

What is Power over Ethernet?

Power over Ethernet refers to the ability to power network devices directly over the existing data connection, eliminating the need for an external power supply for each device. With Power over Ethernet, devices such as IP telephones, wireless LAN access points, security cameras and other enterprise terminals can safely receive power over legacy Category 5 or better LAN cabling without modifying the existing infrastructure. Power over Ethernet is also a necessity for the Voice-over-IP (VoIP) solution as this service requires an alternative power source for IP phones.

Power over Ethernet consists of two essential components: the power-sourcing equipment (PSE) and the powered devices (PD).

PowerSense — The Cutting-Edge, Modular Approach To Power over Ethernet

Midspan hubs are power-sourcing equipment. These hubs are patch panel-like devices that are installed between the existing Ethernet switch and the devices to be powered (see figure). They add power to the spare pairs of a data cable without disturbing the transmission of the data.

Belden PowerSense Midspan Hubs provide these unprecedented features:

- Full compliance with IEEE 802.3af Standards (PoE Protocol)
- Module options for 48V, 24V, 12V and Cisco CDP™ protocols
- FCC, CE and CB tested and approved for worldwide use
- Modular chassis: 24-, 20-, 10-, 8- and 1-port designs
- Assured safety: each module auto-detects the device’s power requirements before forwarding power; modules allow for transparent 10/100Mb and management operations
- Each module port is voltage isolated with user replaceable fuses and is “hot swappable.”

Key benefits of PowerSense include:

- Work in conjunction with existing Ethernet infrastructure and structured cabling, including the Ethernet switches or shared media devices
- Are the optimal solution for applications such as WLAN, VoIP, Web-based security cameras and access control devices
- Provide a scalable solution: since PowerSense hubs are modular, new modules can be added as required
- Allows a fast recovery from an internal power fault condition; modules may be hot swapped.
- Reduce the total cost of ownership.

To further ensure customer satisfaction, you may try any PowerSense product free for 30 days.

Advanced Replacement Warranty

All PowerSense products have a full 2-year warranty for product quality and durability. We also offer an Advanced Replacement Warranty which means that if a PowerSense product needs to be replaced, a new unit will be immediately shipped.

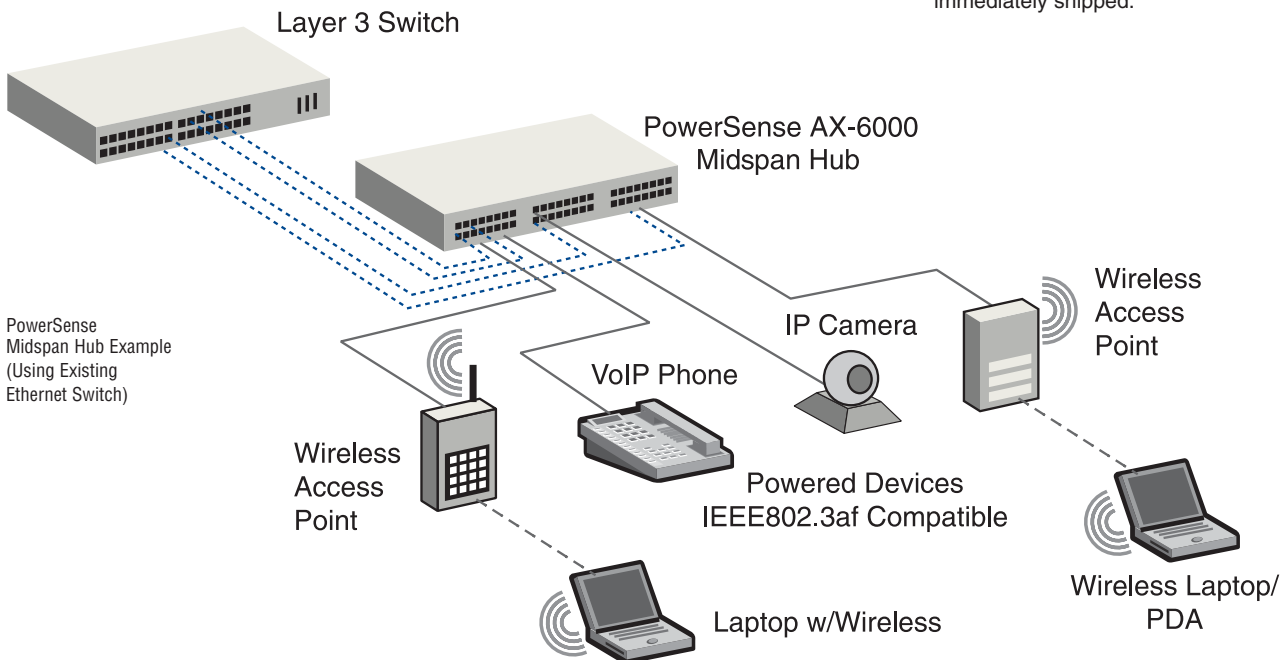

Power Over Ethernet Midspan Hubs

PowerSense AX-8000 Series Modular Multiport

PowerSense 20-Port Midspan Hub
IEEE 802.3af compatible

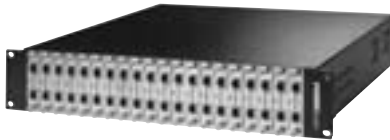

AX-8510 PowerSense 10-Port Midspan Hub
IEEE 802.3af compatible



PowerSense Modules

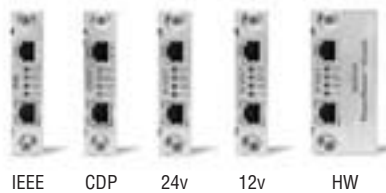

AX-8000 PowerSense Series

The **AX-8000 Modular Multiport In-Line Power Hub** includes 20-slot and 10-slot modular chassis units which may be populated with any combination of PowerSense modules. The individual modules are all hot swappable and fully voltage isolated from each other. These units help reduce costs and downtime by allowing individual modules to be removed or inserted while the chassis and all other modules remain operational.

Modules can be mixed and matched to support CDP™ devices, IEEE 48-volt, 24-volt or 12-volt applications within the same chassis. Power IP phones, wireless access points, security cameras and other low voltage devices safely and efficiently. A **single port model** is also available (see page 14.4) in any of the module styles for single device powering applications.

Description	Belden Part Number
-------------	--------------------

AX-8000 PowerSense Series — Multiport

Chassis Only (without modules)	
20-slot PowerSense chassis – 19" rack mount ready	AX-8220
10-slot PowerSense chassis – w/ rubber feet	AX-8210
10-slot PowerSense chassis – 19" rack mount kit	AX-8210-RM
10-slot PowerSense chassis – wall mount kit	AX-8210-WM
Chassis Complete with 20 Standard Power Chassis Modules	
20 Power and Data modules – 12 volt protocol	AX-8320
20 Power and Data modules – 24 volt protocol	AX-8420
20 Power and Data modules – IEEE 802.3af compatible	AX-8520
20 Power and Data modules – Cisco CDP protocol	AX-8620
Chassis Complete with 10 Standard Power Chassis Modules	
10 Power and Data modules – 12 volt protocol	AX-8310
10 Power and Data modules – 24 volt protocol	AX-8410
10 Power and Data modules – IEEE 802.3af compatible	AX-8510
10 Power and Data modules – Cisco CDP protocol	AX-8610
Standard Power Chassis Modules (for devices up to 15.4 watts, uses 1 slot)	
Power and Data module – 12 volt protocol	AX-8300
Power and Data module – 24 volt protocol	AX-8400
Power and Data module – IEEE 802.3af compatible	AX-8500
Power and Data module – Cisco CDP protocol	AX-8600
High Wattage Chassis Modules (for devices up to 20 watts, uses 2 slots)	
Double Wide Power and Data module – 12 volt protocol	AX-8300HW
Double Wide Power and Data module – IEEE 802.3af compatible	AX-8500HW
Double Wide Power and Data module – Cisco CDP protocol	AX-8600HW
Custom Power Chassis Modules (for specific products)	
Power and Data module, supports AXIS 205 Camera, 12V	AX-8300AXIS205
Power and Data module, supports AXIS 2120 Camera, 12V	AX-8300AXIS2120
Power and Data module, supports IndigoVision Camera, 12V	AX-8300IVC100
Power and Data module, supports SONY SNCRZ30N Camera, 12V	AX-8300SNCRZ30N
Power and Data module, supports SAVI Products, 12V	AX-8300SR600101
Power and Data module, supports IQinvision IQEYE3 Camera, 24V	AX-8400IQEYE3
Power and Data module, supports Trango Broadband AP, 24V	AX-8400M58305AP
Power and Data module, supports Mobotix MX-D-03 Camera, 24V	AX-8400MXD03
Power and Data module, supports Smarteye Camera, 24V	AX-8400SP400101
Chassis Cover Plates (for unused slots)	
Single slot cover plate	AX-8201
Two slot cover plate	AX-8202
Five slot cover plate	AX-8205
Six slot cover plate	AX-8206

Visit www.BeldenIBDN.com for a product compatibility list.

These products are in the process of being assessed for RoHS compliance. Please check our Web Site for the most current RoHS status.



Power Over Ethernet Midspan Hubs

PowerSense AX-8000 Series

Single-Port

PowerSense 1-Port Midspan Hub
IEEE 802.3af compatible



AX-8000 PowerSense Series

For single device powering applications, this **single port version** of the popular AX-8000 PowerSense Series of Modular In-Line Power Hubs is available in any of the same module styles as the multiport version. Modules can support CDP™ devices, IEEE 48-volt, 24-volt or 12-volt applications to power IP phones, wireless access points, security cameras and other low-voltage devices safely and efficiently.

Description	Belden Part Number
-------------	--------------------

AX-8000 PowerSense Series — Single Port Hubs

Standard Power Modules	
Single Power and Data port — 12V Power and Data compatible	AX-8351
Single Power and Data port — 24V Power and Data compatible	AX-8451
Single Power and Data port — IEEE 802.3af compatible	AX-8551
Single Power and Data port — Cisco CDP protocol	AX-8651
High Wattage (for devices up to 20 watts, w/ power supply)	
Double Wide Power and Data module — 12 volt protocol	AX-8351HW
Double Wide Power and Data module — IEEE 802.3af compatible	AX-8551HW
Double Wide Power and Data module — Cisco CDP protocol	AX-8651HW
Custom power modules, with power supply	Various Part Numbers

Visit www.BeldenIBDN.com for a product compatibility list.

These products are in the process of being assessed for RoHS compliance. Please check our Web Site for the most current RoHS status.

Power Over Ethernet Midspan Hubs

PowerSense AX-6000 Series 24-Port, 8-Port Module

PowerSense 24-Port Midspan Hub
IEEE 802.3af compatible



PowerSense 8-Port Midspan Hub
IEEE 802.3af compatible



Individual Chassis Module



AX-6000 PowerSense Series 24-Port

The **AX-6000 Modular Multiport In-Line Power Hub** safely and efficiently provides power over LAN data cabling for VoIP phones, wireless networking access points, IP security cameras and other remote network devices.

The PowerSense In-Line Power Hub provides power to LAN devices without the use of an external power supply for each device. Power is supplied over the existing LAN data cabling system. This greatly increases the flexibility of installation and possible locations for such devices, no longer requiring them to be located near a power outlet. It also adds an unprecedented level of safety and reliability for powered LAN devices.

The PowerSense Hub is a **24-port rack-mount chassis** powering up to 24 devices. Each **8-port module** is hot-swappable and modules may be added to the chassis without powering down the unit. If an individual power port is damaged due to a lightning strike or power surge, the module bank may be hot swapped out without powering down the chassis or disconnecting the other devices attached to the other power ports in the chassis.

When used with an uninterruptible power supply, the PowerSense Hub provides continuous power for up to 24 connected devices. PowerSense is tough and durable, made with an all metal chassis.

PowerSense operates on Category 5, 5e or 6 grade LAN data cable at standard Ethernet distances. The AX-6000 series supports powered devices requiring the IEEE 802.3af PoE protocol.

Description	Belden Part Number
AX-6000 PowerSense Series 24-Port	
Chassis Only (without modules)	
PowerSense Chassis, 3 slots, each slot holds one module	AX-6224
PowerSense Chassis, 1 slot, holds one module	AX-6208
1-slot Chassis (with one standard 6500 module installed)	
8 Power and Data Ports — IEEE 802.3af compatible, 10/100 Mbs	AX-6108
Optional 19" Rack Mount Kit for one slot chassis	AX-6108-RM
3-slot Chassis (with up to three standard 6500 modules installed)	
24 Power and Data Ports — IEEE 802.3af compatible, 10/100Mbs	AX-6524
16 Power and Data Ports and one cover plate — IEEE 802.3af compatible	AX-6516
8 Power and Data Ports and two cover plates — IEEE 802.3af compatible	AX-6508
3-slot Chassis GIG (with up to three 6500GIG modules installed)	
24 Power and Data Ports — IEEE 802.3af compatible, 10/100/1000Mbs	AX-6524GIG
16 Power and Data Ports and one cover plate — IEEE 802.3af compatible	AX-6516GIG
8 Power and Data Ports and two cover plates — IEEE 802.3af compatible	AX-6508GIG
3-slot Chassis HW4 (with up to three 6500HW4 modules installed)	
12 Power and Data Ports — RJ-45, IEEE, High Power (36 watts per port) 10/100Mbs	AX-6512HW4
8 Power and Data Ports — RJ-45, IEEE, High Power (36 watts per port) 10/100Mbs	AX-6508HW4
4 Power and Data Ports — RJ-45, IEEE, High Power (36 watts per port) 10/100Mbs	AX-6504HW4
Spare Chassis Modules (Individual; fits one or three slot chassis)	
8 Power and Data Ports — RJ-45, IEEE 802.3af compatible, 10/100Mbs	AX-6500
8 Power and Data Ports — RJ-45, IEEE 802.3af compatible, 10/100/1000Mbs	AX-6500GIG
4 Power and Data Ports — RJ-45, IEEE, High Power (37 watts per port) 10/100Mbs	AX-6500HW4
Chassis Cover Plates (for unused slots)	
Single Module Cover Plate (covers one module slot)	AX-6201

Visit www.BeldenBDN.com for a product compatibility list.

These products are in the process of being assessed for RoHS compliance. Please check our Web Site for the most current RoHS status.

Power Over Ethernet Accessories

PoE Connectors, Data & Power Splitting “Y” Cables

Power over Ethernet Connector



Power over Ethernet Connectors

Power over Ethernet Connectors allow Cisco 7900 Series VoIP Phones or AP350 or AP1100 to be powered with IEEE 802.3af style 48-volt power over Ethernet.

Power may come from a powered Ethernet switch or midspan power hub. Connector installs near powered device. Two LEDs let user know whether power is originating from an Ethernet switch or midspan power hub.

Description	Belden Part Number
-------------	--------------------

Connectors

Input IEEE 802.3af power from any powered switch or midspan hub	AX-8858-01
Input IEEE 802.3af power from HP Pro Curve powered switch	AX-8858-02

These products are in the process of being assessed for RoHS compliance. Please check our Web Site for the most current RoHS status.

Data Splitting Y Cables



Data & Power Splitting “Y” Cables

Data & Power Splitting “Y” Cables are for 12 volt applications and feature a RJ-45 female/male and male power pin. They provide precise splitting of the signal for accurate performance. Various plug sizes/applications are listed below.

Description	Belden Part Number
-------------	--------------------

Data Splitting Y Cables

2.5 mm plug for AXIS PTA -20, 2100, 2120	AX-820Y-01
2.1 mm plug for Vivotek PTV-20	AX-820Y-02
1.3 mm plug for Intellinet PTI-20	AX-820Y-03
No plug, bare wire for IVC 100	AX-820Y-04
Special connector for Symbol AP 41XX	AX-820Y-05
5.5 mm barrel w/ 1.0 mm center — Sony SNC-RZ30N, Sony PTS-20, AXIS 2130	AX-820Y-06
MAXI 7-pin socket for SAVI Products	AX-820Y-07
CONXALL 6-pin for SAVI SR-600-101	AX-820Y-08
1.0 mm plug for AXIS 205, 210, 230, 241Q/S, 250S	AX-820Y-09
2.1 mm plug on 8” power wire for Symbol AP 3020 series	AX-820Y-10

These products are in the process of being assessed for RoHS compliance. Please check our Web Site for the most current RoHS status.



Commercial Networking: Copper

15



Table of Contents

Commercial Networking — Copper		Page No.
Introduction		15.2-15.5
Belden IBDN System 10GX		15.6-15.8
GigaBIX Multi System		15.9-15.12
BIX Cross-Connect System		15.13-15.17
110 Cross-Connect System		15.18-15.20
Labels		15.21
Patch Panels		15.22-15.24
Workstation Outlets		15.25-15.40
Modular Cords		15.41-15.43
Network Connectivity Products		15.44
Line Protection and Bonding & Grounding		15.45
Certified System Cables		15.46-15.51
Unshielded Twisted Pairs (UTP) Cables		15.46-15.66
Shielded Twisted Pairs (ScTP) Cables		15.67-15.69
Special Application Cables		15.70-15.82

Introduction

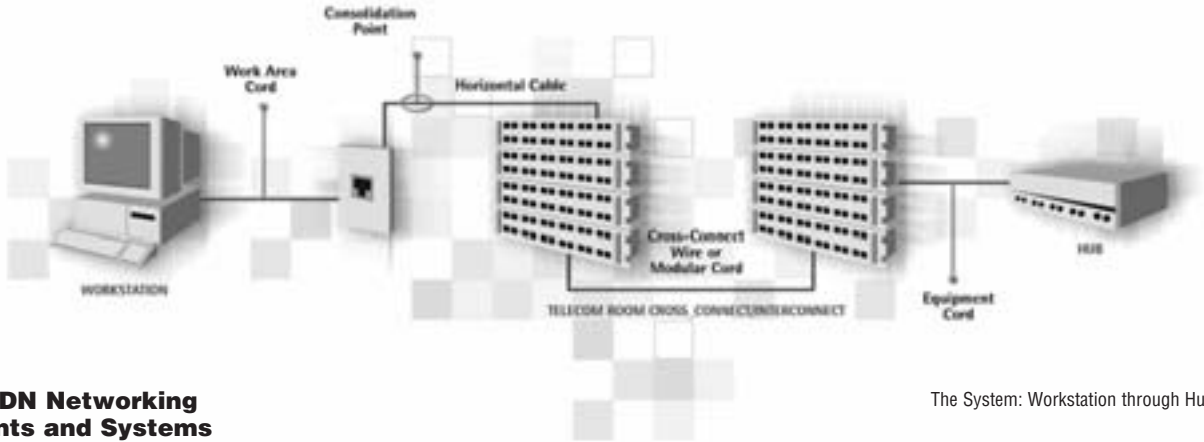

The System: Workstation through Hub

Belden IBDN Networking Components and Systems Overview

Each of the copper cabling components depicted on the following pages is vital to the overall performance of the network, but to achieve optimum network performance you should consider Belden IBDN end-to-end structured cabling systems.

Belden IBDN Copper Structured Cabling Systems are recognized the world over for their high quality since they are the result of both Belden's exceptional design and manufacturing expertise and the system's ability to outperform the standards.

The Revolutionary Belden IBDN System 10GX (Cat. 6a | 10 Gb/s | 625 MHz)

What differentiates our 10GX System from other 10 Gigabit Ethernet offerings? The Belden IBDN System 10GX is not an improved or boosted Category 6 system, but a revolutionary innovation designed around a series of dynamic enabling technologies. Because the 10GX System solves two major performance issues: (1) a reduction in Alien crosstalk to about 15 dB, or 30 times lower than the Alien NEXT for 1000BASE-T at a distance of 100 meters, and (2) the System's ability to control Insertion Loss, Return Loss, NEXT, PSNEXT, Alien PSNEXT, ELFEXT, PSELFEXT and Alien PSFEXT characteristics during high frequency operation — it not only meets the high speed, high bandwidth demands of today's networks, but this advanced solution is ready to meet the challenges of the networks of tomorrow.

System 10GX Performance-Enabling Technologies

The performance of each critical component of the 10GX solution has been optimized through use of the following performance-enabling technologies:

- The system's cable is based upon an innovative SpiralFlex™ design that serves to reduce Alien crosstalk by randomizing the distance between the cables
- A patent-pending IDC design and patch panel circuit layout called MatriX IDC™ technology is utilized to substantially eliminate the issue of Alien crosstalk between the system's modules
- X-Bar™ technology: The X-Bar is a control device that enables the accurate positioning of each UTP pair before the pair is terminated on the 10GX Module's IDC pins
- A patent-pending FlexPoint PCB (printed circuit board) is used within the module housing to position the compensation circuitry directly at the plug's point of contact. Instant compensation delivers excellent crosstalk performance up to 625 MHz!

10GX Cable Design Improves Alien Crosstalk

The major technical challenge for traditional UTP cables resides with the electromagnetic coupling between a cable and its neighboring cables. This coupling is typically enhanced by the fact that all the cable pairs have the same twisting lay and therefore have the same resonance frequencies. Belden's use of SpiralFlex technology introduces randomization in the cable in two ways: (1) it induces with neighboring cables — to accomplish this, a filler is twisted around the four cable pairs — and, (2) to create additional randomization along the full length of the cable, a unique internal cross-web is incorporated into the cable design.

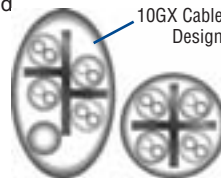

Since these features both increase and randomize the distance between a cable and its neighboring cables, both the ANEXT coupling and RL channel characteristics of the cable are improved. In fact, 10GX Cables were tested in a worst-case scenario — a six-around-one cable environment — and still exhibited performance well over proposed standards. In addition, this unique 10GX Cable design is more flexible and installer-friendly than other 10G cables.

Statistically Controlled Modular Cord Manufacturing

To achieve consistent high performance, Belden uses a statistical process control methodology in its modular cord manufacturing process. This assures perfect tuning between the module and the modular cord and offers improved channel performance. The design of the 10GX Modular Cord is also based upon a patent-pending plug management design that controls dNEXT and delivers extended channel performance.

10GX IDC Design Cancels Out Alien Crosstalk

The IDC is one of the most sensitive areas for Alien crosstalk management. In traditional designs, all of the IDC contacts are aligned so they become perfect antennas, allowing adjacent pairs to both emit and receive noise.

Belden's patent-pending design, called MatriX IDC technology, positions each IDC at 90 degrees to its neighbor — effectively canceling out ANEXT by 15 dB as compared with traditional technology!

Traditional Technology

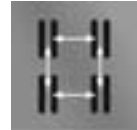

MatriX IDC Technology

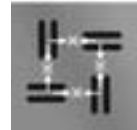

Introduction

(continued)

10GX Module Eliminates Signal Degradation

Traditional jack designs are performance handicapped at high frequencies because of an inherent crosstalk in the plug that cannot be fully compensated for by the jack. This crosstalk occurs because the compensation circuitry is located at some physical distance from the source of the noise, which is at the plug interface. Even a very small physical distance can have a major impact at high frequencies.

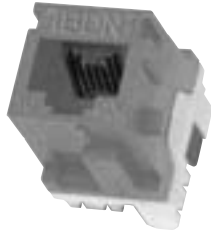

FlexPoint PCB Technology

The 10GX Modules feature FlexPoint PCB technology. This technology incorporates the use of a flexible PCB that allows the compensation circuitry to be located directly at the point of the plug contact. This reduces the delay between the source of the crosstalk in the plug and the crosstalk cancellation circuitry on the PCB. As a result the crosstalk noise at high frequencies is dramatically reduced for outstanding channel performance to 625 MHz!

Error-Free Termination Practices — Installable Performance®

Since structured cabling systems for Category 6 and beyond are extremely sensitive to installation practices, the 10GX System mitigates and simplifies installation issues to ensure overall 10G System performance. To ensure optimum termination of the cable to the module, a new patent-pending technology called the X-Bar was developed. The X-Bar is a plastic device that affixes to the module to ensure that each UTP pair is consistently positioned for termination on the 10GX Module's IDC pins. The X-Bar also controls the amount of unjacketed cable, plus it maintains the conductor twist lays during installation to prevent untwisting. With this consistent termination feature, the superior NEXT and ANEXT performance achieved through use of the system's

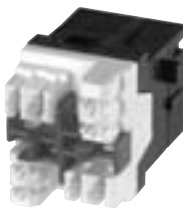

FlexPoint PCB Technology

innovative component designs will be maintained and remain stable throughout the installation process. We call this after-installation assurance *Installable Performance*.

The 10GX Patch Panel With 10GX Modules

Alien crosstalk control within a patch panel is critical to the success of the system. The high density environment of a patch panel can be subjected to crippling amounts of Alien crosstalk. The unique design of the 10GX Module's IDC, and its ability to cancel the "antenna" effect between modules eliminates the Alien crosstalk issue. Because superior ANEXT performance is assured by the module-related technologies, this allows the patch panel ports to be in line. There is no need to compromise on density, and labeling and cable management features are greatly improved. In fact, the module technology is so powerful, Belden is the only manufacturer to be able to offer an ultra high-density solution with 48 ports in a 1U space!

Belden IBDN Category 5e/ Enhanced Category 6 Components and Systems

Belden IBDN Cat. 5e, Cat. 6 and Beyond Cat6® Systems can be designed and installed using either Bonded-Pair UTP cables or nonbonded-pair UTP cables. Both types of cable offer performance well beyond the standards. Bonded-Pair UTP cables — DataTwist® 350, MediaTwist® and DataTwist 600e — feature a patented design that bonds the individual insulated conductors of each pair along the full length of the cable. This bonded construction delivers Installable Performance. That is, Bonded-Pair cables are consistent in the distance between the conductors and in the amount of twist, throughout the installation process, so they deliver the same, superior electrical performance both before and after the cable's installation.

Our nonbonded-pair family of cables include GigaFlex® 1200, 2400 and 4800LX cables. These cables incorporate a patented design which provides complete quality control during the manufacturing process. This allows us to provide high quality cables that consistently offer improved channel performance and large

margins over the standards. These cables will provide the capacity and performance to maximize your overall network performance.

Belden IBDN punch-down GigaFlex Modules are based on a patented Encapsulated Lead Frame technology that ensures long-term reliability, as well as extremely stable transmission performance. Lead frame technology is inherently more reliable than traditional connector technologies as it uses a single, uninterrupted copper contact path through the connector. The design of the GigaFlex Module allows signals to pass virtually unchanged through the connector, providing greater system performance.

GigaBIX® Distribution Connectors, featuring Belden's BIX Technology, are a uniquely designed solution centered around an extremely compact connector equipped with double-sided Insulation Displacement Connection (IDC) clips. The benefit of this unique design is a considerable reduction in the space that would be required by conventional connecting systems of the same pair count. The density of BIX technology is second to none, allowing up to three hundred pairs to be terminated in a very small area — a real space saver, especially in today's office environment where real estate is at a premium.

Belden IBDN System 1200 (Cat. 5e | 1.2 Gb/s | 160 MHz)

If your business is riding the current wave of growth and expansion, you may be considering new ways of doing business and a new or upgraded IT system to support these new strategies. This is the ideal time to plan and implement a new cabling system or to upgrade your existing infrastructure.

This Category 5e system was developed to support high-speed network applications such as Gigabit Ethernet and provides clear bandwidth up to 160 MHz; an increase of 60% over the Cat. 5e standard of 100 MHz. Standards organizations such as TIA/EIA and IEEE now recommend Category 5e cabling systems for all new cabling installations.

Introduction

(continued)

Belden IBDN System 2400 (Cat. 6 | 2.4 Gb/s | 250 MHz)

If leading-edge communication systems are an element of your competitive strategy and if you consider information technology as one of the drivers of your bottom line, you should consider the speed, reliability and performance advantages of this system.

This Category 6 system meets or exceeds all requirements of the TIA/EIA Category 6 standard specifications and delivers 250 MHz bandwidth, a 25% increase over

the 200 MHz bandwidth of typical Category 6 compliant channels. The Belden IBDN System 2400 provides the performance, throughput and reliability necessary to keep your critical applications operating at peak performance.

Belden IBDN System 4800LX (Beyond Cat. 6 | 4.8 Gb/s | 300 MHz)

If every bit of information that your company processes is mission critical, you need the performance and reliability that is built into the Belden IBDN System 4800LX.

This enhanced Category 6 system was conceived to support the most demanding, ultra-high speed and multi-Gigabit protocols, providing blistering performance.

The Belden IBDN System 4800LX is the industry's first 300 MHz system, far exceeding all TIA/EIA Category 6 specifications.

Belden IBDN Copper Systems: Primary Selection of Components

Solutions			Backbone Cable†	Telecom Room
Available Channel Bandwidth	Guaranteed Data Rate	UTP Channel STD Compliance	4-Pair Cables	Cross-Connect Hardware
Belden IBDN System 1200				
160 MHz PowerSum	1.2 Gb/s	Cat. 5e* TIA/EIA ISO/IEC IEEE Gigabit	DataTwist® 350 1700 (CMR) DataTwist 350 1701 (CMP) DataTwist 350 1701 (CMP-50) GigaFlex® 1212 (CMR) GigaFlex 1213 (CMP) GigaFlex 1224 (LSOH)	GigaBIX® Cross-Connect System PS5E BIX Patch Panel PS5E HD-BIX Patch Panel PS5E HD-110 Patch Panel Flex Patch Panel/EZ-MDVO PS5E Module Flex Patch Panel/GigaFlex PS5E Module 110 Cross-Connect System
Belden IBDN System 2400				
250 MHz PowerSum	2.4 Gb/s	Cat. 6** TIA/EIA ISO/IEC IEEE Gigabit	MediaTwist® 1872 (CMR) MediaTwist 1874 (CMP) GigaFlex 2412 (CMR) GigaFlex 2413 (CMP) GigaFlex 2424 (LSOH)	GigaBIX Cross-Connect System GigaFlex PS6+ Patch Panel Flex Patch Panel/GigaFlex PS6+ Module
Belden IBDN System 4800LX				
300 MHz PowerSum	4.8 Gb/s	Beyond Cat6*** TIA/EIA ISO/IEC IEEE Gigabit	DataTwist 600e 7851 (CMR) DataTwist 600e 7852 (CMP) GigaFlex 4812LX (CMR) GigaFlex 4813LX (CMP) GigaFlex 4824LX (LSOH)	GigaBIX Cross-Connect System GigaFlex PS6+ Patch Panel Flex Patch Panel/GigaFlex PS6+ Module
Belden IBDN System 10GX				
625 MHz	10 Gb/s	Beyond 10G Proposed TIA ISO/IEC IEEE 10 Gigabit	10GX 10GX12 (CMR, Nonbonded-pair) 10GX 10GX13 (CMP, Nonbonded-pair) 10GX 10GX24 (LSZH, Nonbonded-pair) 10GX 10GX16 (LC, Nonbonded-pair) 10GX 10GX32 (CMR, Bonded-Pair) 10GX 10GX44 (LSZH, Bonded-Pair) 10GX 10GX66 (LC, Bonded-Pair)	10GX Ultra High-Density Patch Panel (1U, 48 ports) 10GX Patch Panel Flex Patch Panel/10GX Module

*ANSI/TIA/EIA-568-B.1, ISO/IEC 11801 2nd Edition and IEEE 802.3ab. **ANSI/TIA/EIA-568-B.2, ISO/IEC 11801 2nd Edition and IEEE 802.3ab.

†Backbone can be configured with Belden IBDN FiberExpress Optical Fiber Cable.

Installable Performance guarantees are available on Bonded-Pair cables. Since the insulated conductors of the pairs are bonded along their longitudinal axes, Bonded-Pair cables remain intact during the installation process, so there is no separation of pair conductors and no degradation of the cables' electrical characteristics.



Introduction

(continued)

Quality Installation And Service

Belden IBDN systems are designed, installed and field-tested by full trained and certified system contractors and integrators to further assure superior systems performance. They are also backed by a strict System Certification and Warranty Program.

System Certification and Warranty Program

The Belden IBDN Certification Program is a rigorous process that ensures that your Belden IBDN 'Certified' System is composed of Belden IBDN components, and that it has been designed and installed by a factory-trained Certified System Vendor. Belden IBDN 'Certified' Systems are supported by a series of warranties that surpass conventional product warranties.

Certification adds important end-to-end system performance guarantees and ensures full compliance with cabling industry standard specifications — even after system installation (Installable Performance). A 25-year Product Warranty and a Lifetime Application Assurance program accompany each Belden IBDN 'Certified' System installation. These warranty programs include coverage for both parts and labor.

	Horizontal Cable			Work Area	
	Cross-Connect Patch System	4-Pair Cables	Installable Performance ^{®††}	Outlets — Connectors, Faceplates & Adapters	Modular Cords
GigaBIX Cross-Connect Wire GigaBIX Patch Cords GigaFlex PS5E Modular Cords PS5E 110 Patch Cords	DataTwist 350 1700 (CMR) DataTwist 350 1701 (CMP) DataTwist 350 1701 (CMP-50) GigaFlex 1212 (CMR) GigaFlex 1213 (CMP) GigaFlex 1224 (LSOH)	● ● ●	PS5E BIX DVO Outlet EZ-MDVO PS5E Module GigaFlex PS5E Module MediaFlex Outlets Interface Plates MDVO Faceplates MDVO Adapters European-style Faceplates French-style Faceplates	GigaFlex PS5E Modular Cords	
GigaBIX Cross-Connect Wire GigaBIX PS6+ Patch Cords GigaFlex PS6+ Modular Cords	MediaTwist 1872 (CMR) MediaTwist 1874 (CMP) GigaFlex 2412 (CMR) GigaFlex 2413 (CMP) GigaFlex 2424 (LSOH)	● ●	GigaFlex PS6+ Module MediaFlex Outlets Interface Plates MDVO Faceplates MDVO Adapters European-style Faceplates French-style Faceplates	GigaFlex PS6+ Modular Cords	
GigaBIX Cross-Connect Wire GigaBIX PS6+ Patch Cords GigaFlex PS6+ Modular Cords	DataTwist 600e 7851 (CMR) DataTwist 600e 7852 (CMP) GigaFlex 4812LX (CMR) GigaFlex 4813LX (CMP) GigaFlex 4824LX (LSOH)	● ●	GigaFlex PS6+ Module MediaFlex Outlets Interface Plates MDVO Faceplates MDVO Adapters European-style Faceplates French-style Faceplates	GigaFlex PS6+ Modular Cords	
10GX Modular Cords	10GX 10GX12 (CMR, Nonbonded-pair) 10GX 10GX13 (CMP, Nonbonded-pair) 10GX 10GX24 (LSZH, Nonbonded-pair) 10GX 10GX16 (LC, Nonbonded-pair) 10GX 10GX32 (CMR, Bonded-Pair) 10GX 10GX33 (CMP, Bonded-Pair) 10GX 10GX44 (LSZH, Bonded-Pair) 10GX 10GX66 (LC, Bonded-Pair)	● ● ● ● ● ●	10GX Module MediaFlex Outlets Interface Plates MDVO Faceplates MDVO Adapters	10GX Modular Cords	



Belden IBDN System 10GX

10GX Modules and 10GX Patch Panels

AX102272 10GX Module, Black

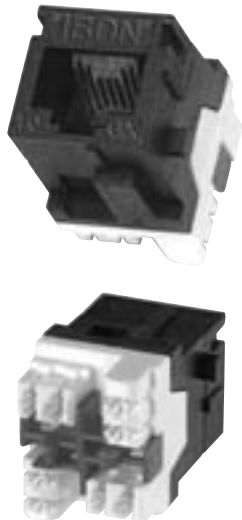

10GX Module

The **10GX Module** is a revolutionary punch down UTP connector designed to be used within the new Belden IBDN System 10GX. In order to achieve true 10G performance, Belden has designed the 10GX Module based on three revolutionary module technologies making the 10GX Module the most advanced 10G module available. It is designed to work in existing hardware including the Flex Modular Patch Panel and MediaFlex Outlet Series. It can also be mixed and matched with a wide variety of adapters and boxes to suit practically any installation configuration for workstation outlet, consolidation point and telecommunications closet applications. The unmatched Beyond 10G™ performance exceeds all parameters specified in the proposed Augmented Category 6 standard. All performance characteristics including ANEXT, NEXT, FEXT, Insertion Loss and Return Loss have been set to guarantee transmission performance up to 625 MHz.

Description	Belden Part Number
Belden IBDN System 10GX	
10GX Module, Augmented Category 6	
MDVO-Style, T568A/B, Gray	AX102269
MDVO-Style, T568A/B, White	AX102271
MDVO-Style, T568A/B, Black	AX102272
MDVO-Style, T568A/B, Red	AX102274
MDVO-Style, T568A/B, Yellow	AX102275
MDVO-Style, T568A/B, Green	AX102276
MDVO-Style, T568A/B, Blue	AX102277
MDVO-Style, T568A/B, Ivory	AX102562

These products are in the process of being assessed for RoHS compliance. Please check our Web Site for the most current RoHS status.

AX102488 10GX Ultra High-Density Patch Panel 1U, 48-port, Titanium

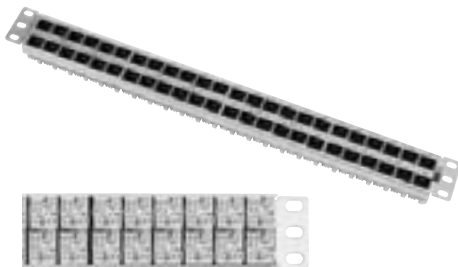

10GX Patch Panel

The 10GX Patch Panel is a fully loaded patch panel designed to be used within the Belden IBDN System 10GX. The 10GX Patch Panel features the revolutionary 10GX Module, specifically designed to meet the difficult challenges of 10 Gb/s transmission. 10GX Patch Panels are available in high-density options such as 24 ports in 1U or 48 ports in 2U, but the phenomenal ANEXT performance of the 10GX Module has allowed Belden to also support an ultra high-density option offering the 10GX Ultra High-Density Patch Panel supporting 48 ports in 1U. The unmatched Beyond 10G™ performance exceeds all parameters specified in the proposed Augmented Category 6 standard. All performance characteristics including ANEXT, NEXT, FEXT, Insertion Loss and Return Loss have been set to guarantee transmission performance up to 625 MHz.

Description	Belden Part Number
Belden IBDN System 10GX	
10GX Ultra High-Density Patch Panel, Augmented Category 6	
1U, 48-port, Titanium	AX102488
10GX Patch Panel, Augmented Category 6	
1U, 24-port, Titanium	AX102293
2U, 48-port, Titanium	AX102296

These products are in the process of being assessed for RoHS compliance. Please check our Web Site for the most current RoHS status.

AX102293 10GX Patch Panel 1U, 24-port, Titanium

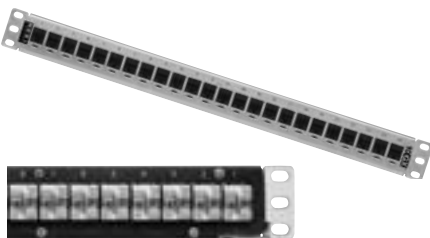

Belden IBDN System 10GX

10GX Modular Cords

AX360015 10GX Modular Cord, Blue



10GX Modular Cords

The **10GX Modular Cords** are 4-pair 23 AWG UTP modular cords designed to be used within the Belden IBDN System 10GX. Belden has designed the 10GX Modular Cord based on a patent-pending management bar design which allows for very good control of the internal plug NEXT. The patch cable design offers very good Alien crosstalk performance, while maintaining the important mechanical characteristics such as flexibility. The 10GX Modular Cords' design, with a very small footprint, makes them fully compatible with the highest density hubs that utilize RJ45 jack connections. The 10GX Modular Cords are available in pantone colors that match the colors per the TIA/EIA-606 standard and the product line encompasses CMR modular cords, as well as open-ended cords. The unmatched performance exceeds all parameters specified in the proposed Augmented Category 6 standard. All performance characteristics have been set to guarantee transmission performance up to 625 MHz.

Description	Belden Part Number					
	Blue	White	Gray	Green	Red	Yellow

Belden IBDN System 10GX

10GX Modular Cord, 4-Pair, 23 AWG Solid, T568A/B - T568A/B, CMR						
2.1 m (7 ft)	AX360015	AX360051	AX360027	AX360021	AX360045	AX360057
3.0 m (10 ft)	AX360016	AX360052	AX360028	AX360022	AX360046	AX360058
4.6 m (15 ft)	AX360017	AX360053	AX360029	AX360023	AX360047	AX360059
7.6 m (25 ft)	AX360018	AX360054	AX360030	AX360024	AX360048	AX360060

10GX Pigtail, 4-Pair, 23 AWG Solid, T568A — Open, CMR	
4.6 m (15 ft)	AX360265
7.6 m (25 ft)	AX360266
10.6 m (35 ft)	AX360267
15.0 m (50 ft)	AX360268

10GX Pigtail, 4-Pair, 23 AWG Solid, T568B — Open, CMR	
4.6 m (15 ft)	AX360269
7.6 m (25 ft)	AX360270
10.6 m (35 ft)	AX360271
15.0 m (50 ft)	AX360272

These products are in the process of being assessed for Gb/s compliance. Please check our Web Site for the most current RoHS status.

Belden IBDN System 10GX

10GX Cables

24826395 10GX Cable Series, White



10GX Cable

The **10GX Cables** are 4-pair 23 AWG UTP cables designed to be used within the Belden IBDN System 10GX. The GX Cable incorporates the use of patent-pending SpiralFlex™ technology, which improves the ANEXT coupling by increasing and randomizing the distance between a cable and the neighboring cables surrounding it. The unmatched Beyond 10G™ performance exceeds all parameters specified in the proposed Augmented Category 6 standard. All performance characteristics including ANEXT, NEXT, FEXT, Insertion Loss and Return Loss have been set to guarantee channel transmission performance up to 625 MHz. The 10GX Cable Series is very complete with cable available with Bonded-Pairs and Nonbonded-pairs, and is available in plenum, non-plenum, and Limited Combustible versions.

Description	Belden Part Number
10GX Cable, Bonded-Pairs	
10GX Cable, CMR	
10GX32 Cable, 4-Pair, 23 AWG UTP, 305 m (1000 ft), Spool, White	24826395
10GX32 Cable, 4-Pair, 23 AWG UTP, 305 m (1000 ft), Spool, Blue	24826995
10GX Cable, CMP	
10GX33 Cable, 4-Pair, 23 AWG UTP, 305 m (1000 ft), Spool, White	24827395
10GX33 Cable, 4-Pair, 23 AWG UTP, 305 m (1000 ft), Spool, Blue	24827995
10GX Cable, LSZH	
10GX44 Cable, 4-Pair, 23 AWG UTP, 305 m (1000 ft), Spool, Purple	24828095
10GX Cable, Limited Combustible	
10GX66 Cable, 4-Pair, 23 AWG UTP, 305 m (1000 ft), Spool, White*	24822395
10GX Cable, Nonbonded-pairs	
10GX Cable, CMR	
10GX12 Cable, 4-Pair, 23 AWG UTP, 305 m (1000 ft), Spool, White	24816395
10GX12 Cable, 4-Pair, 23 AWG UTP, 305 m (1000 ft), Spool, Blue	24816995
10GX Cable, CMP	
10GX13 Cable, 4-Pair, 23 AWG UTP, 305 m (1000 ft), Spool, White	24817395
10GX13 Cable, 4-Pair, 23 AWG UTP, 305 m (1000 ft), Spool, Blue	24817995
10GX Cable, LSZH	
10GX24 Cable, 4-Pair, 23 AWG UTP, 305 m (1000 ft), Spool, Purple	24818095
10GX Cable, Limited Combustible	
10GX16 Cable, 4-Pair, 23 AWG UTP, 305 m (1000 ft), Spool, White*	24812395

*DuPont™ certified limited combustible cable

*DuPont™ certified limited combustible cable

GigaBIX Multi System

Termination Kits and Basic Components

AX101985 GigaBIX Rack Mount Termination Kit, 48-port

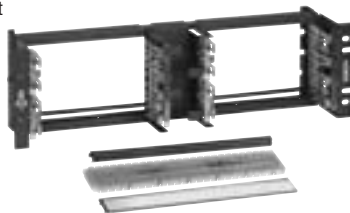

AX101470 GigaBIX Termination Kit, 72-port



AX101447 GigaBIX Connector, 6-port



AX101986 GigaBIX Rack Mount Panel



AX101472 GigaBIX Mount

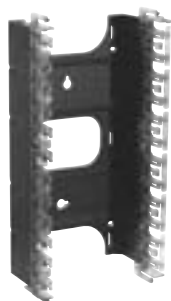

AX101486 GigaBIX Wire Guard



AX101483 GigaBIX Designation Strip, shown here with label

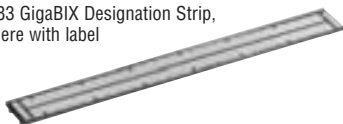

AX101987 GigaBIX/MediaFlex Adapter



GigaBIX Termination Kits

The **GigaBIX Termination Kits** contains all components required to terminate cables in a GigaBIX Cross-Connect or Interconnect System. The Termination Kits allow for the most cost-effective Category 6 cross-connect or interconnect installations using GigaBIX Cross-Connect Wire or GigaBIX PS6+ Patch Cords. The GigaBIX Mount is designed to accommodate high-performance cables. The GigaBIX Connectors have color-coded edges, separation marks and a keying feature that prevents connector insertion in the wrong orientation. Each kit also contains Wire Guards, Designation Strips, Designation Labels, Velcro ties and a detailed installation guide.

GigaBIX Connector

The **GigaBIX Connector** is the core component of the GigaBIX Multi System. Its symmetrical construction allows termination of high-performance cables on one side and GigaBIX Cross-Connect Wires or GigaBIX Patch Cords on the other. Each GigaBIX Connector is equipped with 50 double-ended Insulation Displacement Connection (IDC) clips for terminating plastic insulated solid copper conductors without stripping. The connector is built with two staggered rows of IDC clips enclosed in a three-layer construction of fire-retardant plastic wafers. The GigaBIX Connectors have color-coded edges, separation marks and a keying feature that prevents connector insertion in the wrong orientation. The GigaBIX Connector offers exceptional performance that goes Beyond Category 6 which makes it the ideal choice for gigabit cabling networks.

GigaBIX Mount

The **GigaBIX Mount** for wall installations holds 12 GigaBIX Connectors and is designed to accommodate up to 144 high-performance cables when used in a top-to-bottom cross-connect layout.

The **GigaBIX Rack Mount Panel** allows for customizing rack mount installations for data, voice or multimedia installations. This panel can accommodate up to 8 GigaBIX Connectors, for a total of 48 terminations of 4-pair UTP cables, or up to 4 GigaBIX/MediaFlex Adapters for a total of 48 multimedia ports.

GigaBIX Wire Guard

The **GigaBIX Wire Guards** are plastic strips that snap behind the GigaBIX Connectors after termination to provide strain relief to the twisted pairs. They come as part of the GigaBIX Termination Kits and can also be ordered separately as replacement components.

GigaBIX Designation Strip

The **GigaBIX Designation Strips** are plastic strips that snap between the GigaBIX Connectors to apply the designation labels. They come as part of the GigaBIX Termination Kits and can also be ordered separately as replacement components. (See the LabelFlex section for designation labels.)

GigaBIX/MediaFlex Adapter

The **GigaBIX/MediaFlex Adapter** allows for mixed media installation within the expanded GigaBIX Multi family of connectivity. The GigaBIX/MediaFlex Adapter can accommodate a variety of MediaFlex inserts including UTP and multimedia inserts to customize multimedia installation in Telecommunications Rooms, Equipment Rooms, or Consolidation Points.

Description	Belden Part Number
GigaBIX Multi System	
Termination Kits	
GigaBIX Termination Kit, 72-port	AX101470
GigaBIX Termination Kit, 300-pair	AX101471
GigaBIX Rack Mount Termination Kit, 48-port	AX101985
Basic Components	
GigaBIX Connector, 6-port	AX101447
GigaBIX Connector, 25-pair	AX101448
GigaBIX Mount, 12-connector	AX101472
GigaBIX Rack Mount Panel, 48-port	AX101986
GigaBIX Wire Guard	AX101486
GigaBIX Designation Strip	AX101483
GigaBIX/MediaFlex Adapter	AX101987

These products are in the process of being assessed for RoHS compliance. Please check our Web Site for the most current RoHS status.



GigaBIX Multi System

Patch Cords and Cross-Connect Wire

AX101945 GigaBIX PS6+ Patch Cord, BIX-BIX, 4 ft.



AX101951 GigaBIX PS6+ Patch Cord, BIX-8MOD, 4 ft.



24570521 GigaBIX Cross-connect Wire, 4-pair

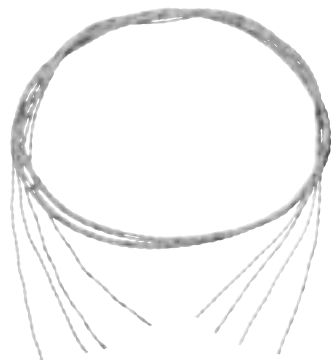

GigaBIX Patch Cords

GigaBIX Patch Cords allow for high-density connections, coupled with flexibility for cost-effective installation and administration. Plug-and-go installation and rearrangement of patch cords do not require any special tools or training. GigaBIX Patch Cords are available in two different configurations: BIX-BIX patch cord configurations for easy cross-connection between equipment and distribution fields, and BIX-8MOD patch cord configurations to easily interconnect equipment utilizing 8-position modular jacks directly into GigaBIX Connectors in the distribution field.

The **GigaBIX PS6+ Patch Cords** are 4-pair 23 AWG UTP cords. They are used in GigaBIX Multi System as part of a Belden IBDN System 2400 and System 4800LX, providing a channel bandwidth of 250 MHz and 300 MHz respectively.

The **GigaBIX PS5E Patch Cords** are used in the GigaBIX Multi System as part of a Belden IBDN System 1200, providing outstanding channel bandwidth of 160 MHz.

Description	Belden Part Number		
	BIX-BIX	BIX-8MOD T568A-ISDN	BIX-8MOD T568B-ALT

GigaBIX Multi System

PS6+ Patch Cords			
4 ft. (1.2 m)	AX101945	AX101951	AX101957
6 ft. (1.8 m)	AX101946	AX101952	AX101958
8 ft. (2.4 m)	AX101947	AX101953	AX101959
10 ft. (3.0 m)	AX101948	AX101954	AX101960
15 ft. (4.6 m)	AX101949	AX101955	AX101961
25 ft. (7.6 m)	AX101950	AX101956	AX101962
PS5E Patch Cords			
4 ft. (1.2 m)	AX101963	AX101969	AX101975
6 ft. (1.8 m)	AX101964	AX101970	AX101976
8 ft. (2.4 m)	AX101965	AX101971	AX101977
10 ft. (3.0 m)	AX101966	AX101972	AX101978
15 ft. (4.6 m)	AX101967	AX101973	AX101979
25 ft. (7.6 m)	AX101968	AX101974	AX101980

These products are in the process of being assessed for RoHS compliance. Please check our Web Site for the most current RoHS status.

GigaBIX Cross-Connect Wire

GigaBIX Cross-Connect Wire is intended for use between GigaBIX cross-connect fields in a Telecommunications Room or in a Main Cross-Connect Frame. Using GigaBIX Cross-Connect Wire allows for very flexible and cost-effective installations. The cut-to-length jumper eliminates need for slack management and guarantees permanent installation aesthetics. The GigaBIX Cross-Connect Wire offers transmission performance that goes Beyond Category 6 providing additional margin to support Gigabit applications.

Color Code: White/Blue, White/Orange, White/Green, White/Brown.

Description	Belden Part Number
-------------	--------------------

GigaBIX Multi System

Cross-Connect Wire	
4-pair, 1000 ft. (305 m), Spool	24570521
4-pair, 1000 ft. (305 m), Spool-in-Box	24577B15

These products are in the process of being assessed for RoHS compliance. Please check our Web Site for the most current RoHS status.



GigaBIX Multi System

Cable Management Accessories

AX102154 GigaBIX Color-Coded Clip



GigaBIX Colored Service Clips

The **GigaBIX Colored Service Clip** is a single-pair plastic clip that snaps on the GigaBIX connectors to visually identify various services when using GigaBIX Cross-Connect Wire.

AX101469 GigaBIX Cable Management Module



GigaBIX Cable Management Module

The **GigaBIX Cable Management Module** is designed to be used with a wall mount solution. The accessory allows all terminated cables to be brought from the same side (top or bottom) in a high-density GigaBIX installation (4-mount stack). The modules are stackable side-to-side and top-to-bottom with alignment features to ease installation. The modules can be used horizontally to create a horizontal management channel for more flexibility in a side-to-side patching layout using GigaBIX Patch Cords.

AX101468 GigaBIX Patch Cord Organizer and AX101521 GigaBIX Patch Cord Organizer Cover

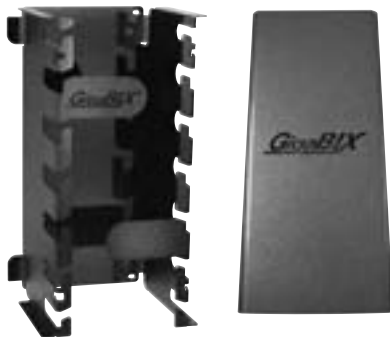

GigaBIX Patch Cord Organizer

The **GigaBIX Patch Cord Organizer** is designed to be used with a wall mount solution. The Patch Cord Organizer is a metal trough that interlocks with GigaBIX Mounts to create a vertical management channel for GigaBIX Patch Cords. The Patch Cord Organizer has six (6) openings per side to nicely dress the patch cords while clearing the labeling area on the GigaBIX Mount. The organizer can be assembled over Cable Management Modules in large patch cord installations. A Patch Cord Organizer Cover can be purchased separately to hide the patch cords and give a very professional and high-tech look to the installation.

GigaBIX Horizontal Channel Plate

GigaBIX Horizontal Channel Plates are metal plates that attach to the Patch Cord Organizers to create a horizontal management channel for GigaBIX Patch Cords. The plates are used in pairs and are designed to keep patch cords inside the horizontal channel.

AX101520 GigaBIX Horizontal Channel Plate



GigaBIX Management Ring

The **GigaBIX Management Ring** is a plastic ring that interlocks with the GigaBIX Mounts to create a high-density wall mount cross-connect system. The rings are assembled in systems when using cross-connect wire and have a capacity of 450 GigaBIX Cross-Connect Wires (1800-pairs total).

AX101478 GigaBIX Management Ring



Description	Belden Part Number
-------------	--------------------

GigaBIX Multi System

Cable Management Accessories	
GigaBIX Color-Coded Clip, Gray	AX102146
GigaBIX Color-Coded Clip, Almond	AX102147
GigaBIX Color-Coded Clip, White	AX102148
GigaBIX Color-Coded Clip, Black	AX102149
GigaBIX Color-Coded Clip, Orange	AX102150
GigaBIX Color-Coded Clip, Red	AX102151
GigaBIX Color-Coded Clip, Yellow	AX102152
GigaBIX Color-Coded Clip, Green	AX102153
GigaBIX Color-Coded Clip, Blue	AX102154
GigaBIX Color-Coded Clip, Purple	AX102155
GigaBIX Color-Coded Clip, Brown	AX102156
GigaBIX Cable Management Module	AX101469
GigaBIX Patch Cord Organizer	AX101468
GigaBIX Patch Cord Organizer, Cover	AX101521
GigaBIX Horizontal Channel Plate	AX101520
GigaBIX Management Ring	AX101478

These products are in the process of being assessed for RoHS compliance. Please check our Web Site for the most current RoHS status.

GigaBIX Multi System

Cable Management Accessories

GigaBIX Distribution Frame & Accessories

GigaBIX Distribution Frames provide a compact mounting unit for large cross-connect installations of data or voice services.

The **GigaBIX Distribution Frame** can accommodate up to (16) 12-connector GigaBIX Mounts, eight on the equipment side and eight on the distribution side. The GigaBIX Distribution Frame has a capacity of 1152 ports or 4800 pairs. It is backwards compatible with BIX Mounts (QMBIX12E) and can be used to continue a row of BIX Distribution Frames (QFBIX24E).

The **GigaBIX Frame End Kit** consists of eight (8) cable trays and eight (8) distribution rings plus appropriate mounting hardware. One kit is required to support GigaBIX Cross-Connect Wires on the sides of a single-frame installation or on the end frames of a multi-frame installation.

The **GigaBIX Overhead Kit** consists of two (2) metal bars and four (4) “J” bolts plus appropriate mounting hardware to support cable ladder (not included) running over a row of GigaBIX Distribution Frames.

Description	Belden Part Number
-------------	--------------------

GigaBIX Multi System

Cable Management Accessories	
Distribution Frame, 1152 ports/4800 pairs	AX102073
Frame End Kit	AX102082
Frame Overhead Kit	AX102145

These products are in the process of being assessed for RoHS compliance. Please check our Web Site for the most current RoHS status.

AX102073 GigaBIX Distribution Frame

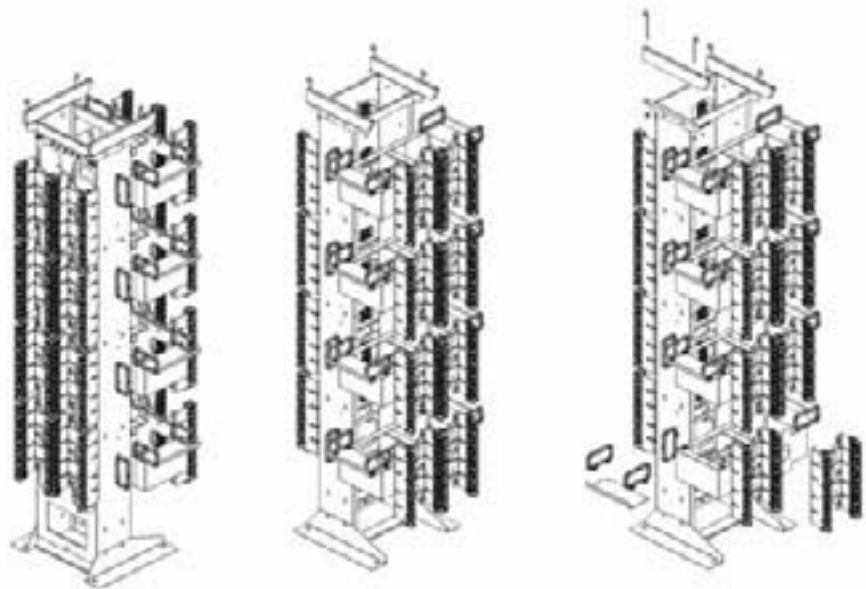

BIX Cross-Connect System

Distribution Connectors, Multiplying Connectors and Modular Jack Connectors

A0393146 QCBIX1A4 Connector



A0266827 QCBIX5A Multiplying Connector

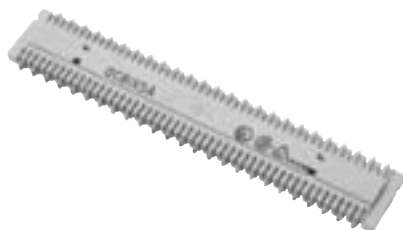

AX100798 BIX Modular Jack Connector

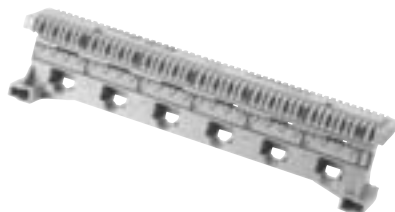

BIX Distribution Connector

The **BIX Distribution Connector** is a 25-pair connector. The connector's symmetrical construction allows termination of cables on one side and cross-connect jumper wires or BIX Patch Cords on the other. Each BIX connector is equipped with 50 double-ended Insulation Displacement Connection (IDC) clips for terminating plastic insulated solid copper conductors without stripping and pair splitters on each side of the connector facilitate wire insertion.

BIX Multiplying Connector

BIX Multiplying Connectors are used to generate multiple outputs from a single input. Construction of these connectors is identical to that of BIX Distribution Connectors, except for the IDC clips which are bridged. BIX Multiplying Connectors are typically used in voice applications.

The QCBIX2A Connector is built using 24 sets of bridged clips (2 clips each). It is used to terminate various facilities where multiples of 2 are required.

The QCBIX5A Connector is built using 10 sets of bridged clips (5 clips each). It is used for multiple jumper connections to the same equipment.

The QCBIX7A Connector is built using 10 sets of bridged clips (four 2-clip and six 7-clip bridged arrangements). It is primarily intended for use with 1A type key telephone systems. Each connector can terminate up to three lines of key equipment providing service to as many as seven key telephone sets per line.

BIX Modular Jack Connector

BIX Modular Jack Connectors provide a fast and flexible method to manage small-to-medium cross-connect installations. These connectors are built with a BIX connector pre-wired to standard modular jacks. They allow front-access termination and patching.

The NXXCBMC6U Connector is a 6-port, 8-position modular connector used for data applications. It exceeds all Category 5e channel requirements when used with PS5E Modular Cords in a Belden IBDN 1200 System.

QCBIX36-type Connectors are used mostly for voice applications. The QCBIX36D connector is a 6-port, 8-position modular connector. It is pre-wired to USOC 8-wire wiring scheme specifications. The QCBIX36C connector is an 8-port, 6-position modular connector. It is pre-wired to USOC 6-wire wiring scheme specifications. The QCBIX36B connector is a 12-port, 6-position modular connector. It is pre-wired to USOC 4-wire wiring scheme specifications.

Description	Belden Part Number
-------------	--------------------

BIX Cross-Connect System

Distribution Connector

BIX Distribution Connector, 5-pair Marking	A0266828
BIX Distribution Connector, 4-pair Marking	A0393146

Multiplying Connector

BIX Multiplying Connector, QCBIX2A, 25-pair, 12x2-pair	A0269923
BIX Multiplying Connector, QCBIX5A, 25-pair, 5x5-pair	A0266827
BIX Multiplying Connector, QCBIX7A, 25-pair, 2x2-pair & 3x7-pair	A0269925

Modular Jack Connector

BIX Modular Jack Connector, NXXCBMC6U, 6-port, PS5E, T568A/B Coded	AX100798
BIX Modular Jack Connector, QCBIX36D, 6-port, USOC, 8-pin	A0341173
BIX Modular Jack Connector, QCBIX36C, 8-port, USOC, 6-pin	A0330864
BIX Modular Jack Connector, QCBIX36B, 12-port, USOC, 4-pin	A0330863

These products are in the process of being assessed for RoHS compliance. Please check our Web Site for the most current RoHS status.

BIX Cross-Connect System

Mounts, Covers and Wire Management Accessories

A0340836 QMBIX12E BIX Mount, 300-pair



A0284798 QMBIX10C BIX Mount, 50-pair

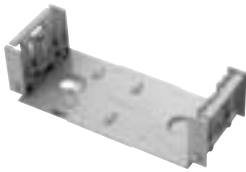

A0277853 QMBIX31A 50-pair Mount with Locking Cover



A0285986 Locking Cover for 250-pair Mount



A0276396 BIX Cover, QMBIX10A, Stand-alone installation, Locking



A0270168 Distribution Ring



BIX Mount

BIX Mounts are basic components used in building a cross-connect system. They can accept BIX Distribution, Multiplying or Modular Jack Connectors. The 300 and 250-pair mounts can be wall-mounted or installed on BIX Frames. These mounts feature an interlocking design allowing them to be stacked for larger cross-connect installations.

The **BIX 50-pair Mount** is typically used in small cross-connect installations. Also available is a 50-pair mount with cover that is sold as an assembly and is typically used in small cross-connect installations where security and/or dust protection is required.

BIX Cover

BIX Covers can be used to restrict access of cross-connect installations for better protection and security. Two sizes are available to suit either the QMBIX12E 300-pair mount or the QMBIX10A 250-pair mount. The two locking covers used in wall or frame-mounted installations are molded with translucent plastic allowing visual inspection. Also available are two covers used exclusively in stand-alone QMBIX10A 250-pair mount installations: one locking, the other non-locking—both have four cable entries, one at each corner.

Distribution Ring

The **Distribution Ring** is used in wall mount installations providing a cross-connect channel for jumper wires, patch cords and cables. The Distribution Ring interlocks with the QMBIX12E or QMBIX10A mounts, providing proper spacing and alignment.

Description	Belden Part Number
BIX Cross-Connect System	
BIX Mount	
BIX Mount, QMBIX12E (300-pair)	A0340836
BIX Mount, QMBIX10A (250-pair)	A0270164
BIX Mount, QMBIX10C (50-pair)	A0284798
BIX Mount with Cover	
BIX Mount with Cover, (Locking), 50-pair	A0277853
BIX Mount with Cover, (Snap-on), 50-pair	A0277854
BIX Locking Cover	
BIX Locking Cover, for QMBIX12E (300-pair)	A0340838
BIX Locking Cover, for QMBIX10A (250-pair)	A0285986
BIX Cover	
BIX Cover, QMBIX10A, Stand-alone installation, locking	A0276396
BIX Cover, QMBIX10A, Stand-alone installation, non-locking	A0276394
Distribution Ring	
Distribution Ring	A0270168

These products are in the process of being assessed for RoHS compliance. Please check our Web Site for the most current RoHS status.

BIX Cross-Connect System

BIX Distribution Frames, Universal BIX-PAC and Trunk Access Blocks

A0340837 BIX Frame



A0321776 Universal BIX-PAC Version 10-10

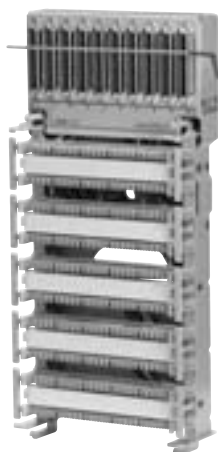

A0318897 BIX PAC Enclosure



A0327326 BIX Trunk Access Block

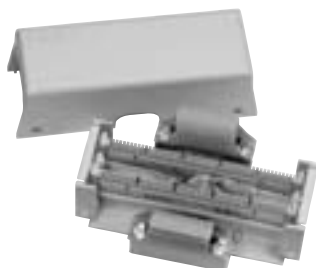

BIX Distribution Frame

BIX Distribution Frames provide a compact mounting unit for large cross-connect installations. The QFBIX24E BIX Frame can accommodate up to 16 QMBIX12E 300-pair mounts, eight on the vertical side and eight on the horizontal side. The QFBIX24E BIX Frame has a capacity of 4800-pair. The QFBIX24A BIX Frame can accommodate up to 16 QMBIX10A 250-pair mounts, eight on the vertical side and eight on the horizontal side. The QFBIX24A BIX Frame has a capacity of 4000-pair.

The BIX Frame End Kit consists of eight cable trays and eight distribution rings plus appropriate mounting hardware. One kit is required to support cross-connect wires on the sides of the shelves in a single-frame installation or on the end frames of a multi-frame installation.

The Distribution Rings are plastic rings used to manage cross-connect wires.

Universal BIX-PAC

The Universal BIX-PAC provides a fast, factory-wired, pre-tested and easy-to-install method of terminating wiring for the voice environment. A typical application for this product is in the main distribution terminal system or the riser terminal system, where it can provide connectivity and cross-connection for up to 250 pairs. The units come equipped with up to 10 QCBIX1A Connectors and 10 fifty-pin type telco connectors for the termination of connectorized cables. Also available is a BIX-PAC Enclosure, which is a fire-retardant polystyrene structural foam box that can house one BIX-PAC. The enclosure has a snap-on cover and removable panels for cable entry on top, bottom and sides.

BIX Trunk Access Block

BIX Trunk Access Blocks provide a fast, factory-wired, pre-tested and easy-to-install method for demarcation or testing points on customer premises. Typical applications are in the building entrance system or the main distribution terminal system, where the demarcation point between the network provider and the customer equipment usually can be found.

Description	Belden Part Number
BIX Cross-Connect System	
BIX Distribution Frame	
BIX Distribution Frame, 4800-pair (4 Shelves for 16 Mounts, 300-pair)	A0340837
BIX Distribution Frame, 4000-pair (4 Shelves for 16 Mounts, 250-pair)	A0275511
BIX Distribution Frame Accessories	
BIX Distribution Frame Accessories, End Kit (4 Shelves)	A0275512*
BIX Distribution Frame Accessories, Distribution Ring	P0596540*
Universal BIX-PAC	
Universal BIX-PAC, 10-8, 8 RJ21X Female to 8 QCBIX1A Connectors	A0321775
Universal BIX-PAC, 10-10, 10 RJ21X Female to 10 QCBIX1A Connectors	A0321776
BIX PAC Enclosure	
BIX PAC Enclosure, Gray	A0318897
BIX Trunk Access Block	
BIX Trunk Access Block, 1 RJ21X Female to 1 QCBIX1A Connector	A0327325
BIX Trunk Access Block, 2 RJ21X Female to 2 QCBIX1A Connector	A0327326

*Eight Distribution Rings come as part of the BIX Distribution Frame End Kit. Additional Distribution Rings can be ordered separately. Use (1) end kit per row of frames.

These products are in the process of being assessed for RoHS compliance. Please check our Web Site for the most current RoHS status.



BIX Cross-Connect System

BIX Patch Cords and B-Plus Cross-Connect Wire

A0410494 BIX Patch Cord, BIX-BIX, 2-pair

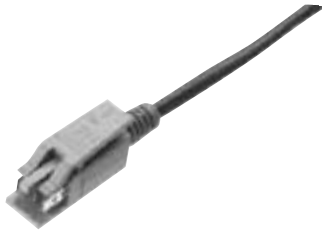

A0410469 BIX Patch Cord, BIX-BIX, 1-pair



22208260 B-Plus Cross-Connect Wire



BIX Patch Cords

BIX Patch Cords allow for high-density connections, coupled with flexibility for cost-effective installation and administration. Installation and rearrangement of patch cords do not require any special tools or training. BIX Patch Cord plugs terminate directly into QCBIX1A/1A4 connectors.

B-Plus Cross-Connect Wire

B-Plus Cross-Connect Wire is intended primarily for use between incoming cables and station equipment in a Telecommunications Room or at a Main Cross-Connect.

Z Cross-Connect Wire is intended primarily for use in voice applications such as cross-connecting PBX or Key Telephone system equipment to backbone or horizontal distribution cables.

Description	Belden Part Number
-------------	--------------------

BIX Cross-Connect System

BIX Patch Cord

BIX Patch Cord, BIX-BIX, 2-pair, 1.2 m (4 ft.)	A0410494
BIX Patch Cord, BIX-BIX, 1-pair, 1.2 m (4 ft.)	A0410469
BIX Patch Cord, BIX-BIX, 2-pair, 2.1 m (7 ft.)	A0410495
BIX Patch Cord, BIX-BIX, 1-pair, 2.1 m (7 ft.)	A0410471
BIX Patch Cord, BIX-BIX, 2-pair, 3.0 m (10 ft.)	A0410496
BIX Patch Cord, BIX-BIX, 1-pair, 3.0 m (10 ft.)	A0410473
BIX Patch Cord, BIX-BIX, 2-pair, 4.6 m (15 ft.)	A0410497
BIX Patch Cord, BIX-BIX, 1-pair, 4.6 m (15 ft.)	A0410475
BIX Patch Cord, BIX-BIX, 1-pair, 7.6 m (25 ft.)	A0410493

For 4-pair connections, please see the GigaBIX Patch Cord section.

B-Plus Cross-Connect Wire

24 AWG, 1-pair, Wh/Bl, 305 m (1000 ft.), K-Carton	22208250
24 AWG, 1-pair, Wh/Bl, 305 m (1000 ft.), Spool (S77)	22208253
24 AWG, 2-pair, Wh/Bl/Wh/Or, 305 m (1000 ft.), K-Carton	22208260
24 AWG, 2-pair, Wh/Gr/Wh/Or, 305 m (1000 ft.), K-Carton	22208231
24 AWG, 3-pair, Wh/Bl/Wh/Or/Wh/Gr, 152 m (500 ft.), K-Carton	22208265
24 AWG, 3-pair, Wh/Bl/Wh/Or/Wh/Gr, 200 m, K-Carton	22208235
24 AWG, 4-pair, Wh/Bl/Wh/Or/Wh/Gr/Wh/Br, 152 m (500 ft.), K-Carton	22208270

Z Cross-Connect Wire

Z Cross-Connect Wire, 24 AWG, 1-pair, Bl/Ye, 300 m (984 ft.), Spool	22208010
Z Cross-Connect Wire, 24 AWG, 1-pair, Bl/Rd, 300 m (984 ft.), Spool	22208067

These products are in the process of being assessed for RoHS compliance. Please check our Web Site for the most current RoHS status.

BIX Cross-Connect System

BIX Tools, Testing Tools, Accessories and Designation Strip

A0270165 BIX Connecting Tool

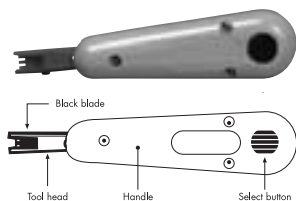

Tool in CUT position Tool in NO CUT position



C0054642 Tool Pouch



A0270166 BIX Test Probe



A0270172 Special Service Guard



A0325493 Bridging Clip



P0660798 BIX Wire Retainer



C0039222 BIX Cable Tie

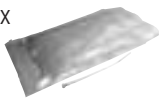

A0352331 19 in. Rack Bracket Kit



A0270169 BIX Designation Strip



BIX Connecting Tool

The **BIX Connecting Tool** is the only tool required to terminate cables, pigtails or jumper wires on all GigaBIX and BIX connection products. The BIX Connecting Tool is a spring-activated hand tool. A single forward movement will seat the wire into the BIX IDC clip and cut off the excess wire. The tool will terminate 22-26-AWG plastic insulated solid copper conductors. A separate leather BIX Tool Pouch to carry and protect the BIX Tool can be ordered.

BIX Test Probe

The **BIX Test Probe** is a single-pair probe that clips onto the termination clip of BIX Distribution or BIX Modular Jack Connectors to facilitate testing.

BIX Accessories

The **BIX Special Service Guard** is a single-pair red plastic clip used to identify a connection within a BIX distribution field that requires special attention prior to any maintenance work.

The **BIX Bridging Clip** is a single-pair clip used to bridge single-pair connections of two BIX connectors.

The **BIX Wire Retainer** is a plastic extrusion that fits over the terminated wires on a BIX Connector to prevent them from being pulled out of the IDC contacts. It can be used to secure a permanent connection on either side of a BIX Connector.

This **19 in. Rack Bracket Kit** provides the hardware for BIX Mount installation into a 19 in. rack. This kit comes complete with two mounting bars, four screws for rack mounting, four screws for BIX Mount assemblies and an installation guide.

BIX Cable Ties are used for securing wire bundles to the BIX Connector.

BIX Designation Strip

The **BIX Designation Strip** is designed to be used in conjunction with all BIX Mounts and BIX Connectors. It snaps in between two connectors and provides space for self adhesive BIX labels. The strip is made of white fire-retardant plastic, with ridges on the top and bottom for easy alignment and placement of designation labels. (See the LabelFlex section for designation labels.)

Description	Belden Part Number
BIX Cross-Connect System	
BIX Tools	
BIX Connecting Tool	A0270165
Tool Pouch	C0054642
BIX Test Probe	
BIX Test Probe, 1-pair, 1/pack	A0270166
BIX Accessories	
BIX Special Service Guard, 1-pair, Red, 50/pack	A0270172
BIX Bridging Clip, 1-pair, Gray, 50/pack	A0325091
BIX Bridging Clip, 1-pair, White, 50/pack	A0325493
BIX Wire Retainer, 100/pack	P0660798
19 in. Rack Bracket Kit, 2 bars/pack	A0352331
BIX Cable Tie, 100/pack	C0039222
BIX Designation Strip	
BIX Designation Strip, White, 50/pack	A0270169

These products are in the process of being assessed for RoHS compliance. Please check our Web Site for the most current RoHS status.

110 Cross-Connect System

110 Cross-Connect Kits, 110 Connecting Blocks, 110 Wall Mount Frame Kits and 110 Wiring Blocks

AX100694 110 Cross-Connect Kit, 100-pair

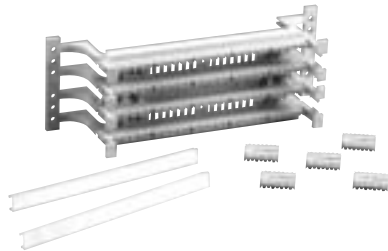

AX100696 110 Cross-Connect Kit, 300-pair

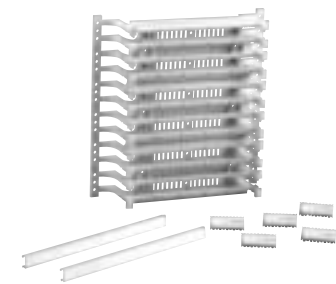

AX100707 110 Connecting Block, 4-pair



AX100708 110 Connecting Block, 5-pair

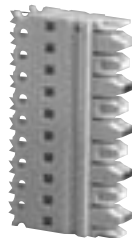

AX100697 110 Wall Mount Frame Kit, 300-pair

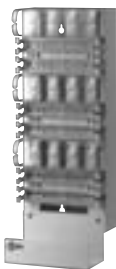

AX100692 Wiring Block, 300-pair

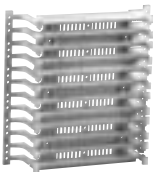

AX100691 Wiring Block, 100-pair



110 Cross-Connect Kit

110 Cross-Connect Kits contain all material required to terminate distribution or equipment cables into a 110 Cross-Connect System. Kits consist of one Wiring Block (100-pair or 300-pair) with legs, Connecting Blocks (4-pair or 5-pair), Designation Strips and Labels.

110 Connecting Block

The **110 Connecting Blocks** are modular connectors equipped with double-sided Insulation Displacement Connection (IDC) clips that are used to terminate plastic insulated solid copper conductors in 110 Wiring Blocks. The color-coded connecting blocks are available in 4-pair and 5-pair configurations. These blocks are compatible with other existing 110 Cross-Connect Systems.

110 Wall Mount Frame Kit

110 Wall Mount Frame Kits simplify planning, organizing and implementation of wall mounted cross-connect systems. They are available in 300-pair and 900-pair configurations making them ideal for small telecommunications room installations. Kits consist of wiring blocks and cable management troughs to be mounted on a cable channel. Kits include all components required to complete a 110 Cross-Connect installation with either 4-pair or 5-pair connecting blocks.

110 Wiring Block

110 Wiring Blocks are rigid plastic indexing strip assemblies designed to hold and align wires prior to terminating 110 Connecting Blocks. 110 Wiring Blocks are available in 100-pair and 300-pair configurations with legs and 100-pair without legs. 110 Wiring Blocks are compatible with 22 to 26 AWG wires and accept 4-pair or 5-pair Connecting Blocks. They are specially designed to simplify data cabling installations. A deeper channel and open slots in the base allow cable to be brought close to the termination point. These blocks are compatible with other existing 110 Cross-Connect Systems.

Description	Belden Part Number
110 Cross-Connect System	
110 Cross-Connect Kit	
110 Cross-Connect Kit, 100-pair, with 4-pair Connecting Blocks	AX100693
110 Cross-Connect Kit, 100-pair, with 5-pair Connecting Blocks	AX100694
110 Cross-Connect Kit, 300-pair, with 4-pair Connecting Blocks	AX100695
110 Cross-Connect Kit, 300-pair, with 5-pair Connecting Blocks	AX100696
110 Connecting Block	
110 Connecting Block, 110C4, 4-pair	AX100707
110 Connecting Block, 110C5, 5-pair	AX100708
110 Wall Mount Frame Kit	
110 Wall Mount Frame Kit, 300-pair, with 4-pair Connecting Blocks	AX100697
110 Wall Mount Frame Kit, 300-pair, with 5-pair Connecting Blocks	AX100698
110 Wall Mount Frame Kit, 900-pair, with 4-pair Connecting Blocks	AX100699
110 Wall Mount Frame Kit, 900-pair, with 5-pair Connecting Blocks	AX100700
110 Wiring Block	
110 Wiring Block, 100-pair, without legs	AX100690
110 Wiring Block, 100-pair, with legs	AX100691
110 Wiring Block, 300-pair, with legs	AX100692

The 110 Cross-Connect System is not available in all countries.

These products are in the process of being assessed for RoHS compliance. Please check our Web Site for the most current RoHS status.

110 Cross-Connect System

110 Designation Strip and Management Accessories

AX100721 110 Designation Strip



110 Designation Strip

The **110 Designation Strip** is designed to be used in conjunction with all 110 Wiring Blocks. It snaps in between two rows of 110 Connecting Blocks and provides space to insert a designation label. The strip is made of clear PVC.

AX100705 Cable Management Trough

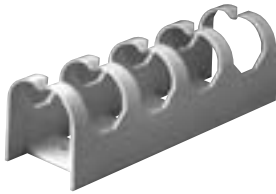

110 Management Accessories

Cable Management Troughs are utilized as channels positioned between wiring blocks for horizontal or vertical dressing of cross-connect wires and patch cords. They are available with and without mounting legs.

Cable Management Rings are used for management of cross-connect wires and cables in 110 Cross-Connect Systems. They can be mounted directly onto a plywood backboard between columns of wiring blocks. They are available in two different sizes.

Wall Mount Cable Management Frames are pre-assembled vertical cable managers that are used between 110 Wall Mount Frame Kits for vertical management of patch cords. They simplify planning and installation of 110 Cross-Connect Systems. They are available in two sizes to use with 300-pair and 900-pair Wall Mount Frame Kits.

AX100706 Cable Management Trough with Legs

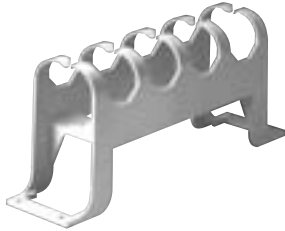

Description	Belden Part Number
-------------	--------------------

110 Cross-Connect System

110 Designation Strip	
110 Designation Strip	AX100721
110 Management Accessories	
Cable Management Trough, without legs	AX100705
Cable Management Trough, with legs	AX100706
Cable Management Ring, Small 144.8 mm (5.7 in.)	AX100703
Cable Management Ring, Large 216 mm (8.5 in.)	AX100704
Wall Mount Cable Management Frame, 300-pair	AX100701
Wall Mount Cable Management Frame, 900-pair	AX100702

AX100703 Cable Management Ring

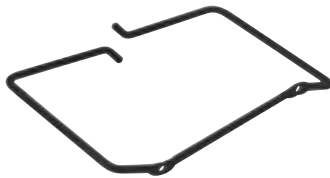

The 110 Cross-Connect System is not available in all countries.

These products are in the process of being assessed for RoHS compliance. Please check our Web Site for the most current RoHS status.

AX100701 Wall Mount Cable Management Frame, 300-pair



110 Cross-Connect System

110 Patch Cords

AX300001 PS5E 110 Patch Cord, 110-110, 4-pair



AX300010 PS5E 110 Patch Cord, 110-8MOD, 4-pair



AX300013 110 Patch Cord, 110-110, 2-pair



110 Patch Cord

110 Patch Cords allow for high density connections in a 110 Cross-Connect System. 110 Patch Cord rearrangements do not require any special tools or training thus providing flexibility for cost-effective installation and administration. 110 Patch Cords are available in two different configurations. 110-110 patch cord configurations are used for easy cross-connection between equipment and distribution fields.

110-8MOD patch cord configurations are used to easily interconnect equipment utilizing 8-position modular jacks directly into 110C4/C5 connecting blocks in the distribution field. PS5E 110 Patch Cords offer Category 5e performance. These patch cords are compatible with other existing 110 Cross-Connect systems.

110 Patch Cord Connector

110 Patch Cord Connectors are available in 1, 2 and 4-pair configurations for field assembly of Category 5 patch cords. They can terminate plastic insulated stranded copper conductors 24 AWG.

Description	Belden Part Number
110 Cross-Connect System	
110 Patch Cord	
110 Patch Cord, PS5E 110-110, 4-pair, 1.2 m (4 ft.)	AX300001
110 Patch Cord, PS5E 110-110, 4-pair, 1.8 m (6 ft.)	AX300002
110 Patch Cord, PS5E 110-110, 4-pair, 2.4 m (8 ft.)	AX300025
110 Patch Cord, PS5E 110-110, 4-pair, 3.0 m (10 ft.)	AX300026
110 Patch Cord, PS5E 110-110, 4-pair, 6.1 m (20 ft.)	AX300027
110 Patch Cord, PS5E 110-8MOD, 4-pair, T568A, 1.2 m (4 ft.)	AX300010
110 Patch Cord, PS5E 110-8MOD, 4-pair, T568A, 1.8 m (6 ft.)	AX300009
110 Patch Cord, PS5E 110-8MOD, 4-pair, T568A, 2.4 m (8 ft.)	AX300029
110 Patch Cord, PS5E 110-8MOD, 4-pair, T568A, 3.0 m (10 ft.)	AX300030
110 Patch Cord, PS5E 110-8MOD, 4-pair, T568A, 6.1 m (20 ft.)	AX300032
110 Patch Cord, PS5E 110-8MOD, 4-pair, T568B, 1.2 m (4 ft.)	AX300008
110 Patch Cord, PS5E 110-8MOD, 4-pair, T568B, 1.8 m (6 ft.)	AX300005
110 Patch Cord, PS5E 110-8MOD, 4-pair, T568B, 2.4 m (8 ft.)	AX300011
110 Patch Cord, PS5E 110-8MOD, 4-pair, T568B, 3.0 m (10 ft.)	AX300034
110 Patch Cord, PS5E 110-8MOD, 4-pair, T568B, 6.1 m (20 ft.)	AX300017
110 Patch Cord, 110-110, 2-pair, 1.2 m (4 ft.)	AX300013
110 Patch Cord, 110-110, 2-pair, 1.8 m (6 ft.)	AX300014
110 Patch Cord, 110-110, 2-pair, 2.4 m (8 ft.)	AX300015
110 Patch Cord, 110-110, 2-pair, 3.0 m (10 ft.)	AX300037
110 Patch Cord, 110-110, 2-pair, 6.1 m (20 ft.)	AX300038
110 Patch Cord, 110-110, 1-pair, 0.6 m (2 ft.)	AX300039
110 Patch Cord, 110-110, 1-pair, 1.2 m (4 ft.)	AX300006
110 Patch Cord, 110-110, 1-pair, 1.8 m (6 ft.)	AX300007
110 Patch Cord, 110-110, 1-pair, 2.4 m (8 ft.)	AX300012
110 Patch Cord, 110-110, 1-pair, 3.0 m (10 ft.)	AX300021
110 Patch Cord, 110-110, 1-pair, 6.1 m (20 ft.)	AX300040
110 Patch Cord Connector	
110 Patch Cord Connector, 4-pair	AX100711
110 Patch Cord Connector, 2-pair	AX100710
110 Patch Cord Connector, 1-pair	AX100709

The 110 Cross-Connect System is not available in all countries. Other lengths are available, please contact Customer Service for further details.

These products are in the process of being assessed for RoHS compliance. Please check our Web Site for the most current RoHS status.

Labels

LabelFlex

AX101537 LabelFlex Labels



LabelFlex Automated Labeling Solution

The LabelFlex solution is aimed at simplifying network management. Using the labeling system (software and label types), the installer can rapidly produce quality, application specific labels for most Belden IBDN products in a fraction of the time taken by traditional methods.

The range of Belden IBDN products covered by the labeling system is:

- GigaBIX & BIX Cross-Connect Systems
- BIX Modular Jack Connectors
- 110 Cross-Connect System
- GigaFlex PS6+ Patch Panels
- Flex Patch Panels
- Workstation Outlets
- MediaFlex Faceplates series
- Cable Applications, 4-pair and 25-pair
- ID Tubes
- PS5E HD Patch Panels

Description	Belden Part Number
Labels for MediaFlex Faceplates	
Almond/Silver, 30 labels/sheet, 10 sheets/pack	AX101820
White, 30 labels/sheet, 10 sheets/pack	AX101821
Labels for BIX and GigaBIX	
Gray, 15 labels/sheet, 5 sheets/pack	AX101532
White, 15 labels/sheet, 5 sheets/pack	AX101533
Orange, 15 labels/sheet, 5 sheets/pack	AX101534
Red, 15 labels/sheet, 5 sheets/pack	AX101535
Yellow, 15 labels/sheet, 5 sheets/pack	AX101536
Green, 15 labels/sheet, 5 sheets/pack	AX101537
Blue, 15 labels/sheet, 5 sheets/pack	AX101538
Purple, 15 labels/sheet, 5 sheets/pack	AX101539
Brown, 15 labels/sheet, 5 sheets/pack	AX101540
Silver, 15 labels/sheet, 5 sheets/pack	AX101541
Labels for BIX Modular Jack Connector	
Gray, 28 labels/sheet, 5 sheets/pack	AX101542
White, 28 labels/sheet, 5 sheets/pack	AX101543
Orange, 28 labels/sheet, 5 sheets/pack	AX101544
Red, 28 labels/sheet, 5 sheets/pack	AX101545
Yellow, 28 labels/sheet, 5 sheets/pack	AX101546
Green, 28 labels/sheet, 5 sheets/pack	AX101547
Blue, 28 labels/sheet, 5 sheets/pack	AX101548
Purple, 28 labels/sheet, 5 sheets/pack	AX101549
Brown, 28 labels/sheet, 5 sheets/pack	AX101550
Silver, 28 labels/sheet, 5 sheets/pack	AX101584
Labels for Patch Panels, Outlets and Cables	
Labels for Flex Patch Panels, White, 28 labels/sheet, 5 sheets/pack	AX101551
Labels for Workstation Faceplates, White, 80 labels/sheet, 25 sheets/pack	AX101552
Labels for Workstation Single Port ID, White, 450 labels/sheet, 5 sheets/pack	AX101553
Labels for HD Patch Panels, White, 18 labels/sheet, 5 sheets/pack	AX101554
Labels for GigaFlex PS6+ Patch Panels, White, 28 labels/sheet, 5 sheets/pack	AX101626
Labels for 4-pair cables, Gray, 48 labels/sheet, 25 sheets/pack	AX101555
Labels for 25-pair cables, White, 24 labels/sheet, 25 sheets/pack	AX101556
Labels for 110 Cross-Connect	
Gray, 18 labels/sheet, 5 sheets/pack	AX101557
White, 18 labels/sheet, 5 sheets/pack	AX101558
Orange, 18 labels/sheet, 5 sheets/pack	AX101559
Red, 18 labels/sheet, 5 sheets/pack	AX101560
Yellow, 18 labels/sheet, 5 sheets/pack	AX101561
Green, 18 labels/sheet, 5 sheets/pack	AX101562
Blue, 18 labels/sheet, 5 sheets/pack	AX101563
Purple, 18 labels/sheet, 5 sheets/pack	AX101564
Brown, 18 labels/sheet, 5 sheets/pack	AX101565
Labels for ID Tubes	
3.1 in. long, White, 32 labels/sheet, 5 sheets/pack	AX101566
4.4 in. long, White, 30 labels/sheet, 5 sheets/pack	AX101567
7.4 in. long, White, 19 labels/sheet, 5 sheets/pack	AX101568
Software	
Automated LabelFlex Advanced Software, 1 CD/pack	AX101569

These products are in the process of being assessed for RoHS compliance. Please check our Web Site for the most current RoHS status.



Patch Panels

GigaFlex PS6+ Patch Panels Category 6

AX101613 GigaFlex PS6+ Patch Panel, 2U, 48-port



GigaFlex PS6+ Patch Panel

The **GigaFlex PS6+ Patch Panel** is a fully loaded patch panel using black GigaFlex PS6+ Modules. The unmatched performance of the GigaFlex PS6+ Module exceeds all parameters specified in the Category 6 standard. All performance characteristics including NEXT, FEXT, Attenuation and Return Loss have been set to guarantee transmission performance up to 300 MHz and a data-rate of up to 4.8 Gb/s.

Description	Belden Part Number
-------------	--------------------

Patch Panels

GigaFlex PS6+ Patch Panel

GigaFlex PS6+ Patch Panel, 1U, 24-port, Gray	AX101612
GigaFlex PS6+ Patch Panel, 1U, 24-port, Black	AX101611
GigaFlex PS6+ Patch Panel, 2U, 48-port, Gray	AX101614
GigaFlex PS6+ Patch Panel, 2U, 48-port, Black	AX101613

These products are in the process of being assessed for RoHS compliance. Please check our Web Site for the most current RoHS status.

Patch Panels

PS5E HD Patch Panels Category 5E,
PS5E BIX Patch Panels Category 5E and Flex Patch Panels

AX100465 PS5E HD Patch Panel, 1U, 24-port



AX100473 PS5E HD Patch Panel, 2U, 48-port



AX100506 BIX Patch Panel, 2U, 24-port



AX101456 Flex Patch Panel

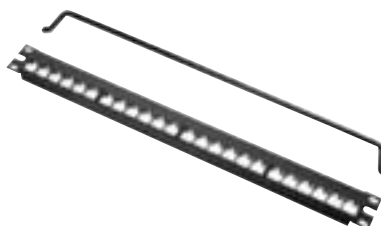

PS5E HD Patch Panel

The **Universal PS5E HD Patch Panels** Series includes a variety of product styles, sizes and wiring configurations. PS5E HD Patch Panels are robust and installer-friendly products by design, combining punch down connectors with standard modular jacks. They are available in both BIX and 110 Insulation Displacement Connection (IDC) options. A color-coded icon labeling system can be used to tag each patch panel port and simplify network management (ordered separately). PS5E HD Patch Panels offer Category 5E performance.

PS5E BIX Patch Panel

The **PS5E BIX Patch Panel** is a medium density panel, 24-port in 2 rack space units, for easier installation and cable management than high density panels. The PS5E BIX Patch Panel is a robust and installer-friendly product by design, combining BIX punch down connectors with standard modular jacks. The patch panel features built-in wire management to secure cable bundles and to control and maintain patch cord bend radius. A color-coded icon labeling system can be used to tag each patch panel port and simplify network management (ordered separately). The PS5E BIX Patch Panel offers Category 5E performance.

Flex Patch Panel

Flex Patch Panels provide a flexible and versatile termination solution for telecommunications room rack-mounted installations. The panels can be custom configured in the field to suit practically any particular configuration. Flex Patch Panels are compatible with GigaFlex and EZ-MDVO modules as well as MDVO-style Multimedia modules. Modules are ordered separately.

Description	Belden Part Number
Patch Panels	
PS5E HD Patch Panel	
PS5E HD-BIX Patch Panel, 1U, 24-port, Gray, T568A/B	AX100464
PS5E HD-BIX Patch Panel, 1U, 24-port, Black, T568A/B	AX100465
PS5E HD-BIX Patch Panel, 2U, 48-port, Gray, T568A/B	AX100472
PS5E HD-BIX Patch Panel, 2U, 48-port, Black, T568A/B	AX100473
PS5E HD-110 Patch Panel, 1U, 24-port, Black, T568B/A	AX100452
PS5E HD-110 Patch Panel, 2U, 48-port, Black, T568B/A	AX100454
The PS5E HD-110 Patch Panel is not available in all countries. Other configurations are available, please contact Customer Service for further details.	
PS5E BIX Patch Panel	
PS5E BIX Patch Panel, 2U, 24-port, Gray, T568A-ISDN	AX100505
PS5E BIX Patch Panel, 2U, 24-port, Black, T568A-ISDN	AX100506
Flex Patch Panel	
Flex Patch Panel, 1U, 24-port, Gray	AX101571
Flex Patch Panel, 1U, 24-port, Black	AX101456
Flex Patch Panel, 2U, 48-port, Gray	AX101573
Flex Patch Panel, 2U, 48-port, Black	AX101458

These products are in the process of being assessed for RoHS compliance. Please check our Web Site for the most current RoHS status.

Patch Panels

PS5E HD Patch Boxes Category 5E, Connector Modules and Identification Accessories

AX100284 HD Patch Box, Closed



AX100284 HD Patch Box, Open



AX100282 MDVO Patch Box



AX100461 HD-110 Universal Connector Module

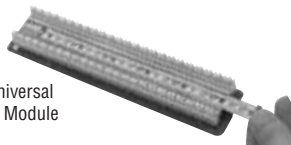

AX100458 HD-BIX Universal Connector Module

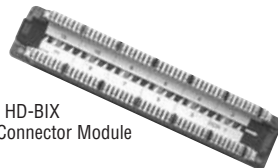

AX100599 PS5E BIX Connector Module, Front



AX100599 PS5E BIX Connector Module, Back



AX100435 Color-Coded Icon Kit

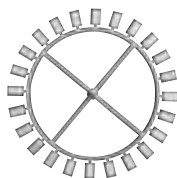

AX101093 Clear ID Tubes



PS5E HD Patch Box

The **PS5E HD Patch Boxes** are available in BIX and 110 configurations and hold one 12-port universal connector module in a compact and robust metal enclosure. The patch box features a hinged cover and support brackets to secure cables and maintain patch cord bend radius. A color-coded icon labeling system can be used to tag each patch panel port and simplify network management (ordered separately) All performance parameters, including NEXT, Attenuation and Return Loss are designed to meet the Category 5E Cabling standard.

An **MDVO Patch Box** is also available that can be custom configured in the field using up to 12 GigaFlex, EZ-MDVO or MDVO Multimedia Modules. Modules are ordered separately.

PS5E HD-BIX Universal Connector Module

The **PS5E HD Universal Connector Module** is a 12-port UTP Module with a BIX or 110 termination interface that is used as a replacement module in the PS5E HD Patch Panels and Patch Boxes.

PS5E BIX Connector Module

The **PS5E BIX Connector Module** is a 2-port UTP Module with BIX termination interface that is used as a replacement module in the PS5E BIX Patch Panel 24-port.

Color-Coded Icon Kit

Color-Coded Icons can be used to tag each outlet port as data or voice and simplify network management. The snap-on icons can be used with PS5E HD Patch Panels, PS5E HD Patch Boxes, PS5E BIX Patch Panels, MediaFlex GigaFlex Inserts, PS5E DVO Workstation Outlets. They cannot be used with any of the Interface or MDVO plates, adapters or boxes.

Clear Plastic Identification Tubes

The **Clear Plastic ID Tubes** are new and improved plastic tubes designed to be used primarily in conjunction with the PS5E HD BIX and 110 Patch Panels and Patch Boxes. The tubes are made of clear fire-retardant plastic, with double-sided adhesive on one side. They are available in three different lengths for easy compatibility with 4, 6 or 12-port openings of the patch panels. They are sold in bags of 100 units only. The bags contain 100 ID tubes and 100 white labels.

Description	Belden Part Number
Patch Panels	
PS5E HD-BIX Patch Box	
PS5E HD-BIX Patch Box, 12-port, Gray, T568A/B	AX100283
PS5E HD-BIX Patch Box, 12-port, Black, T568A/B	AX100284
PS5E HD-110 Patch Box, 12-port, Black, T568B/A	AX100491
The PS5E HD-110 Patch Box is not available in all countries.	
MDVO Patch Box	
MDVO Patch Box, 12-port, Gray	AX100281
MDVO Patch Box, 12-port, Black	AX100282
PS5E HD-BIX Universal Connector Module	
PS5E HD-BIX Universal Connector Module, Universal wiring 12-port, T568A/B	AX100458
PS5E HD-110 Universal Connector Module, Universal wiring 12-port, T568B/A	AX100461
The PS5E HD-110 Universal Connector Module is not available in all countries.	
PS5E BIX Connector Module	
PS5E BIX Connector Module, 2-port, T568A-ISDN	AX100599
Color-Coded Icon Kit	
Color-Coded Icon Kit, Gray, 12 data, 6 voice, 6 blank icons	AX100435
Color-Coded Icon Kit, Almond, 12 data, 6 voice, 6 blank icons	AX100436
Color-Coded Icon Kit, White, 12 data, 6 voice, 6 blank icons	AX100437
Color-Coded Icon Kit, Black, 12 data, 6 voice, 6 blank icons	AX100438
Color-Coded Icon Kit, Orange, 12 data, 6 voice, 6 blank icons	AX100439
Color-Coded Icon Kit, Red, 12 data, 6 voice, 6 blank icons	AX100440
Color-Coded Icon Kit, Yellow, 12 data, 6 voice, 6 blank icons	AX100441
Color-Coded Icon Kit, Green, 12 data, 6 voice, 6 blank icons	AX100442
Color-Coded Icon Kit, Blue, 12 data, 6 voice, 6 blank icons	AX100443
Color-Coded Icon Kit, Purple, 12 data, 6 voice, 6 blank icons	AX100444
Color-Coded Icon Kit, Brown, 12 data, 6 voice, 6 blank icons	AX100445
Clear Plastic Identification Tubes	
Clear Plastic Identification Tubes, 188 mm (7.4 in.), HDBIX/110	AX101093
Clear Plastic Identification Tubes, 112 mm (4.4 in.), MDVO Patch Box	AX101094
Clear Plastic Identification Tubes, 79 mm (3.1 in.), MDVO, 4-port	AX101095

These products are in the process of being assessed for RoHS compliance. Please check our Web Site for the most current RoHS status.



Workstation Outlets

GigaFlex PS6+ Modules Category 6

AX101067 GigaFlex PS6+Module

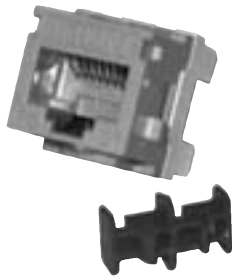

GigaFlex PS6+ Module

The **GigaFlex PS6+ Module** is a punch down UTP connector based on a patented Encapsulated Lead Frame technology ensuring excellent long-term reliability as well as extremely stable transmission performance. The unmatched Beyond Cat6 performance exceeds all parameters specified in the Category 6 standard. All performance characteristics have been set to guarantee transmission performance up to 300 MHz and a data-rate of up to 4.8 Gb/s.

The GigaFlex PS6+ is the module of choice for terminating UTP cables into the MediaFlex and Interface Outlet Series. It can also be mixed and matched with a wide variety of MDVO adapters, boxes and patch panels to suit practically any installation configuration for workstation outlet, consolidation point and telecommunications room applications.

A keystone-style is also available for terminating UTP cables into keystone-style mounting hardware. It can be easily snapped into simple sheet metal cut-outs (panel mounting) for installation into consolidation point or multi-user custom-built devices.

Also available is the GigaFlex PS6+ Module, Clipsal-style which is fully compatible with Clipsal faceplates and mounting hardware.

Description	Belden Part Number		
	MDVO-Style	Keystone-Style	Clipsal-Style

Workstation Outlets

GigaFlex PS6+ Module			
T568A/B, Gray	AX101063	AX101318	AX101340
T568A/B, Almond	AX101064	AX101319	AX101341
T568A/B, White	AX101065	AX101320	AX101342
T568A/B, Black	AX101066	AX101321	AX101343
T568A/B, Orange	AX101067	AX101322	AX101344
T568A/B, Red	AX101068	AX101323	AX101345
T568A/B, Yellow	AX101069	AX101324	AX101346
T568A/B, Green	AX101070	AX101325	AX101347
T568A/B, Blue	AX101071	AX101326	AX101348
T568A/B, Purple	AX101072	AX101327	AX101349
T568A/B, Brown	AX101073	AX101328	AX101350
T568A/B, Ivory	AX102563		

These products are in the process of being assessed for RoHS compliance. Please check our Web Site for the most current RoHS status.

Workstation Outlets

GigaFlex PS5E Modules Category 5E and Flex Modules, USOC-coded

AX101051 GigaFlex PS5E Module



AX101037 Flex Module, USOC-coded



GigaFlex PS5E Module

The **GigaFlex PS5E Module** is a punch down UTP connector based on a patented Encapsulated Lead Frame technology ensuring excellent long term reliability as well as extremely stable transmission performance. The PS5E-rated performance exceeds all requirements specified in the Category 5e standard. All performance parameters including NEXT, FEXT, Attenuation and Return Loss have been set to guarantee transmission performance up to 160 MHz and a data-rate of up to 1.2 Gb/s.

The GigaFlex PS5E is the module of choice for terminating UTP cables into the MediaFlex and Interface Outlet Series. It can also be mixed and matched with a wide variety of MDVO adapters, boxes and patch panels to suit practically any installation configuration for workstation outlet, consolidation point and telecommunications room applications.

A keystone-style is also available for terminating UTP cables into keystone-style mounting hardware. It can be easily snapped into simple sheet metal cut-outs (panel mounting) for installation into consolidation point or multi-user custom-built devices.

Flex Module, USOC-coded

The **Flex Module USOC-coded** is a punch down UTP connector that has a narrower plug entrance and a USOC 6-pin color code in the back. These modules are used for voice applications and are designed to prevent connecting the computer into the analog phone jack, which may cause damages to the electronics.

The Flex Module is the module of choice for voice applications in the MediaFlex and Interface Outlet Series. It can also be mixed and matched with a wide variety of MDVO adapters, boxes and patch panels to suit practically any installation configuration for workstation outlet, consolidation point and telecommunications rooms applications.

Description	Belden Part Number	
	MDVO-Style	Keystone-Style

Workstation Outlets

GigaFlex PS5E Module		
T568A/B, Gray	AX101044	AX101307
T568A/B, Almond	AX101045	AX101308
T568A/B, White	AX101046	AX101309
T568A/B, Black	AX101047	AX101310
T568A/B, Orange	AX101048	AX101311
T568A/B, Red	AX101049	AX101312
T568A/B, Yellow	AX101050	AX101313
T568A/B, Green	AX101051	AX101314
T568A/B, Blue	AX101052	AX101315
T568A/B, Purple	AX101053	AX101316
T568A/B, Brown	AX101054	AX101317
T568A/B, Ivory	AX102564	
Flex Module, USOC-coded, 6-position		
Gray	AX101033	
Almond	AX101034	
White	AX101035	
Black	AX101036	
Orange	AX101037	
Red	AX101038	
Yellow	AX101039	
Green	AX101040	
Blue	AX101041	
Purple	AX101042	
Brown	AX101043	
Ivory	AX102565	

These products are in the process of being assessed for RoHS compliance. Please check our Web Site for the most current RoHS status.



Workstation Outlets

EZ-MDVO PS5E Modules Category 5E and EZ-MDVO Modules, USOC-coded

AX100654 EZ-MDVO PS5E Module



AX100177 EZ-MDVO Module, USOC-coded

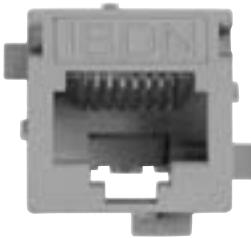

EZ-MDVO PS5E Module

The **EZ-MDVO Module** is built with a patented lead frame design and encapsulated insulation displacement contacts, ensuring reliable connections and performance well above Category 5E standards. The EZ-MDVO module termination cap is what is so unique about this product. It allows for a simple and fast “press-fit” installation while ensuring consistent wire termination every time it is snap-locked. The module termination cap is color-coded to facilitate wire arrangement and speed up installation time. The termination cap is printed with the T568A/B color-codes. The EZ-MDVO Modules can be mixed and matched with a wide variety of MediaFlex, Interface and MDVO-style faceplates, adapters and boxes to suit practically any installation configuration for workstation outlet installations.

A keystone-style is also available for terminating UTP cables into keystone-style mounting hardware. It can be easily snapped into simple sheet metal cut-outs (panel mounting) for installation into consolidation point or multi-user custom-built devices. Clipsal-style EZ-MDVO Modules are available for installations using commercially available Clipsal faceplates and HPM-style EZ-MDVO Modules are available for installations using commercially available HPM faceplates.

EZ-MDVO Module, USOC-coded

The **EZ-MDVO Module USOC-coded** has a narrower plug entrance and is designed to be used for voice applications. These modules prevent connecting the computer into the analog phone jack, which may cause damages to the electronics. Also available is the EZ-MDVO Module, USOC-coded keystone style.

Description	Belden Part Number			
	MDVO-Style	Keystone-Style	Clipsal-Style	HPM-Style

Workstation Outlets

EZ-MDVO PS5E Module				
T568A/B coded, Gray	AX100645	AX100577	AX100678	AX100667
T568A/B coded, Almond	AX100646	AX100578	AX100679	AX100668
T568A/B coded, White	AX100647	AX100579	AX100680	AX100669
T568A/B coded, Black	AX100648	AX100580	AX100681	AX100670
T568A/B coded, Orange	AX100649	AX100581	AX100682	AX100671
T568A/B coded, Red	AX100650	AX100582	AX100683	AX100672
T568A/B coded, Yellow	AX100651	AX100583	AX100684	AX100673
T568A/B coded, Green	AX100652	AX100584	AX100685	AX100674
T568A/B coded, Blue	AX100653	AX100585	AX100686	AX100675
T568A/B coded, Purple	AX100654	AX100586	AX100687	AX100676
T568A/B coded, Brown	AX100655	AX100587	AX100688	AX100677
EZ-MDVO Module, USOC-coded, 6 position				
Gray	AX100171	AX100588		
Almond	AX100172	AX100589		
White	AX100173	AX100590		
Black	AX100174	AX100591		
Orange	AX100175	AX100592		
Red	AX100176	AX100593		
Yellow	AX100177	AX100594		
Green	AX100178	AX100595		
Blue	AX100179	AX100596		
Purple	AX100180	AX100597		
Brown	AX100181	AX100598		

These products are in the process of being assessed for RoHS compliance. Please check our Web Site for the most current RoHS status.

Workstation Outlets

MediaFlex Faceplate Kits and MediaFlex Plates

AX101786 MediaFlex Faceplate Kit, 6-port

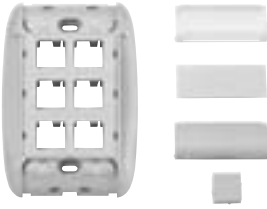

AX101779 MediaFlex Faceplate Kit, 2-port



AX101785 MediaFlex Faceplate Kit, 4-port

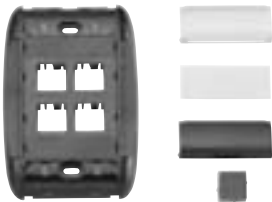

AX101748 MediaFlex Plate, Single Gang



AX101869 MediaFlex Plate, Double Gang



MediaFlex Faceplate Kit

MediaFlex Plates and Inserts snap together to create a full line of modular workstation outlets. This product line, called the MediaFlex Modular Outlet Series, has been designed with the help of industrial designers as well as other professionals in the industry in order to combine flexibility, ease of use and high-tech aesthetics for work area installations.

Even though the MediaFlex series is a modular outlet system, ease and flexibility in ordering and inventory management are also considered with the offering of pre-configured faceplate kits (includes plate, flush MDVO-style inserts, filler inserts, MDVO blank, labeling window covers, labeling paper and all necessary mounting screws).

MediaFlex Plate

MediaFlex Plates are one part of the comprehensive line of plates and inserts that snap together to create a full line of modular workstation outlets.

MediaFlex Plates can be mounted over standard NEMA type outlet boxes and rings to provide support for a variety of MediaFlex Adapters and Inserts. The fully modular construction combined with the front access design provides extensive configuration flexibility for current and future network needs. MediaFlex Plates are available in Single gang and Double gang configurations.

The Double gang faceplate comes with a stand-off ring included in the package. This ring allows for easy mounting with virtually any industry electrical box or mud/adaptor rings, therefore providing added installation flexibility.

Each plate has the capacity of up to 6 ports per Single gang and 12 ports per Double gang.

Description	Belden Part Number		
	2-Port Flush	4-Port Flush	6-Port Flush

Workstation Outlets

MediaFlex Faceplate Kit			
Gray	AX101778	AX101782	AX101786
Almond	AX101779	AX101783	AX101787
Elec. White	AX101780	AX101784	AX101788
Black	AX101781	AX101785	AX101789
White	AX102621	AX102622	AX102623
Ivory	AX102566	AX102567	AX102568

Description	Belden Part Number	
	Single Gang	Double Gang

MediaFlex Plate		
Gray	AX101745	AX101869
Almond	AX101746	AX101870
Elec. White	AX101747	AX101871
Black	AX101748	AX101872
White	AX102608	AX102609
Ivory	AX102569	AX102570

These products are in the process of being assessed for RoHS compliance. Please check our Web Site for the most current RoHS status.

Workstation Outlets

MediaFlex Adapter Boxes and MediaFlex Inserts

AX101874 MediaFlex Adapter Box, Double Gang

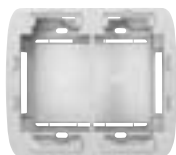

MediaFlex Surface Adapter Box

MediaFlex Surface Adapter Boxes are one part of the comprehensive line of plates and inserts that snap together to create a full line of modular workstation outlets.

MediaFlex Surface Adapter Boxes can be mounted over standard NEMA type outlet boxes and rings to provide support for the MediaFlex plates. The MediaFlex Surface Adapter Boxes are available as a Double gang configuration. The Double gang box allows more room for cable management and bend radius control.

Description	Belden Part Number					
	Gray	Almond	Elec. White	Black	White	Ivory

Workstation Outlets

MediaFlex Adapter Box						
Single Gang	AX102480	AX102481	AX102482	AX102483	AX102484	AX102485
Double Gang	AX101873	AX101874	AX101875	AX101876	AX102610	AX102571

AX101756 MediaFlex MDVO (style) Insert, 2-port, Angled



MediaFlex Insert

MediaFlex Inserts provide optimum flexibility in configuring multimedia workstation outlets that respond to any present or future network needs. MediaFlex MDVO-style Inserts along with MediaFlex Filler Inserts and MediaFlex GigaFlex Inserts allow for the easy configuration of outlets. All inserts are front loaded and easily snapped in and out of the MediaFlex Plates for simple installation and maintenance.

MediaFlex MDVO-style Inserts are available in a 2-port configuration in both Flush and Angled versions. They are compatible with all GigaFlex and MDVO Modules (EZ-MDVO and Multimedia). The inserts are two units high for the flush version and three units high for the angled version. Therefore three flush inserts or two angled inserts are required to fully populate a Single gang MediaFlex Plate.

MediaFlex GigaFlex Inserts are available in a 2-port configuration in both PS5E (Category 5E) and PS6+ (Beyond Category 6) performance levels. The inserts are two units high, therefore three inserts can be used to fully populate a Single gang MediaFlex Plate making up a 6-port outlet.

MediaFlex Filler Inserts are used to fill the unused spaces in low density workstation outlets. They are available in one unit and two unit sizes.

AX101752 MediaFlex MDVO (style) Insert, 2-port, Flush

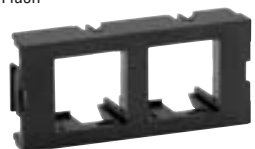

Description	Belden Part Number	
	Flush	Angled

Workstation Outlets

MediaFlex MDVO (style) Insert		
2-port, Gray, bag of 10 units	AX101749	AX101753
2-port, Almond, bag of 10 units	AX101750	AX101754
2-port, Elec. White, bag of 10 units	AX101751	AX101755
2-port, Black, bag of 10 units	AX101752	AX101756
2-port, White, bag of 10 units	AX102612	AX102613
2-port, Ivory, bag of 10 units	AX102572	AX102573

AX101760 MediaFlex Filler Insert, 1-unit



Description	Belden Part Number	
	PS6+	PS5E

MediaFlex GigaFlex Insert		
2-port, Gray	AX101765	AX101769
2-port, Almond	AX101766	AX101770
2-port, Elec. White	AX101767	AX101771
2-port, Black	AX101768	AX101772
2-port, Ivory	AX102574	AX102575

AX101764 MediaFlex Filler Insert, 2-unit



AX101768 PS6+ MediaFlex GigaFlex Insert, 2-port



Description	Belden Part Number	
	1-Unit	2-Unit

MediaFlex Filler Insert		
Gray, bag of 10 units	AX101757	AX101761
Almond, bag of 10 units	AX101758	AX101762
Elec. White, bag of 10 units	AX101759	AX101763
Black, bag of 10 units	AX101760	AX101764
White, bag of 10 units	AX102614	AX102615
Ivory, bag of 10 units	AX102576	AX102577

These products are in the process of being assessed for RoHS compliance. Please check our Web Site for the most current RoHS status.



Workstation Outlets

MediaFlex Inserts (continued)

and Accessories

AX101878 MediaFlex RCA Insert, 3-port, Angled



AX101882 MediaFlex SVHS Insert, 1-port, Angled



AX101886 MediaFlex SVGA Insert, 1-port, Angled



AX101937 MediaFlex SC Duplex Insert, Angled

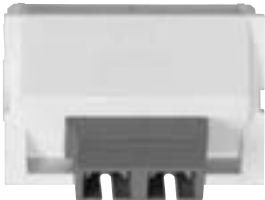

AX101777 Labeling Window Cover



AX101790 Dust Cover



MediaFlex Multimedia Insert

MediaFlex Multimedia Inserts provide optimum flexibility in configuring multimedia workstation outlets that respond to any present or future network needs. MediaFlex Multimedia Inserts along with other MediaFlex Inserts allow for easy configuration of outlets. All inserts are front loaded and easily snapped in and out of the MediaFlex Plates for easy installation and maintenance.

MediaFlex Multimedia inserts include the following products:

- 3-Port RCA insert with IDC termination
- SVHS insert with IDC termination, and feedthrough
- SVGA (DB15) insert with IDC termination
- SC Duplex inserts in MM and SM

MediaFlex Multimedia Inserts are available in Angled versions only in order to allow for proper management of cable bend radius. The inserts are three units high, therefore two inserts are required to fully populate a Single gang faceplate and four inserts will fully populate a Double gang faceplate.

Labeling Window Cover/Dust Cover

MediaFlex Accessories include Labeling Window Covers used with the MediaFlex faceplates and Dust Covers used with the MediaFlex GigaFlex Inserts. Dust Covers can also be used with standard GigaFlex and EZ-MDVO UTP Modules.

Description	Belden Part Number
MediaFlex Multimedia Insert	
3-port RCA, Gray	AX101877
3-port RCA, Almond	AX101878
3-port RCA, Elec. White	AX101879
3-port RCA, Black	AX101880
3-port RCA, White	AX102616
3-port RCA, Ivory	AX102578
1-port SVHS, Gray	AX101881
1-port SVHS, Almond	AX101882
1-port SVHS, Elec. White	AX101883
1-port SVHS, Black	AX101884
1-port SVHS, White	AX102617
1-port SVHS, Ivory	AX102579
1-port SVGA, Gray	AX101885
1-port SVGA, Almond	AX101886
1-port SVGA, Elec. White	AX101887
1-port SVGA, Black	AX101888
1-port SVGA, White	AX102618
1-port SVGA, Ivory	AX102580
SVGA Feedthrough, Gray	AX102334
SVGA Feedthrough, Almond	AX102335
SVGA Feedthrough, Elec. White	AX102336
SVGA Feedthrough, Black	AX102337
SVGA Feedthrough, White	AX102630
SVGA Feedthrough, Ivory	AX102581
SC Duplex Single-mode, Gray	AX101935
SC Duplex Single-mode, Almond	AX101936
SC Duplex Single-mode, Elec. White	AX101937
SC Duplex Single-mode, Black	AX101938
SC Duplex Single-mode, White	AX102619
SC Duplex Single-mode, Ivory	AX102649
SC Duplex Multimode, Gray	AX101939
SC Duplex Multimode, Almond	AX101940
SC Duplex Multimode, Elec. White	AX101941
SC Duplex Multimode, Black	AX101942
SC Duplex Multimode, White	AX102620
SC Duplex Multimode, Ivory	AX102650
MediaFlex Accessories	
Window Cover, Clear, bag of 25 units	AX101773
Window Cover, Gray, bag of 25 units	AX101774
Window Cover, Almond, bag of 25 units	AX101775
Window Cover, Elec. White, bag of 25 units	AX101776
Window Cover, Black, bag of 25 units	AX101777
Dust Cover, Clear, bag of 50 units	AX101790

These products are in the process of being assessed for RoHS compliance. Please check our Web Site for the most current RoHS status.

Workstation Outlets

MDVO Faceplates Flush and Angled

A0405257 MDVO Faceplate, 1-port



A0405294 MDVO Faceplate, 8-port

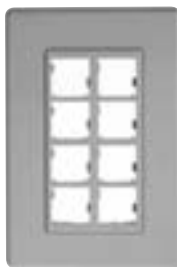

A0620807 MDVO Faceplate, 12-port



A0645267 MDVO Angled Entry Faceplate, shown here with modules



MDVO Faceplate, Flush

MDVO Faceplates flush combine ease of use and aesthetics in work area installations. The Single gang faceplates are available in 1-port and 8-port configurations, Double gang faceplates are configured for 12-ports. The Single gang faceplates can fit over the Interface Surface Adapter Boxes for surface mount installations.

MDVO faceplates are suitable for use with EZ-MDVO and MDVO Multimedia Modules.

MDVO Angled Entry Faceplate

The **MDVO Angled Entry Faceplate** offers better patch cord protection than traditional faceplates and optimizes patch cord bend radius control. The MDVO Angled Entry Faceplate can accept up to four EZ-MDVO or MDVO Multimedia Modules. The faceplate can be attached to standard electrical boxes or wall-mounting hardware for flush-mount installations. The faceplate can also fit over the Interface Surface Adapter Box for surface mount installations.

Description	Belden Part Number
-------------	--------------------

Workstation Outlets

MDVO Faceplate	
Flush, 1-port, Single Gang, Gray	A0405255
Flush, 1-port, Single Gang, Almond	A0405256
Flush, 1-port, Single Gang, White	A0405257
Flush, 1-port, Single Gang, Black	A0405258
Flush, 1-port, Single Gang, Ivory	AX102585
Flush, 8-port, Single Gang, Gray	A0405294
Flush, 8-port, Single Gang, Almond	A0405295
Flush, 8-port, Single Gang, White	A0405296
Flush, 8-port, Single Gang, Black	A0405298
Flush, 8-port, Single Gang, Ivory	AX102586
Flush, 12-port, Double Gang, Gray	A0620806
Flush, 12-port, Double Gang, Almond	A0620807
Flush, 12-port, Double Gang, White	A0620808
Flush, 12-port, Double Gang, Black	A0620809
Flush, 12-port, Double Gang, Ivory	AX102587
MDVO Angled Entry Faceplate	
4-port, Gray	A0645267
4-port, Almond	A0645268
4-port, White	A0645269
4-port, Black	A0645270
4-port, Ivory	AX102588

These products are in the process of being assessed for RoHS compliance. Please check our Web Site for the most current RoHS status.

Workstation Outlets

Interface Plate and Surface Adapter Boxes

AX101431 Interface Plate, 2-port, shown here with modules



AX101438 Interface Plate, 4-port, shown here with modules



AX101441 Interface Plate, 6-port, shown here with modules



AX101474 Interface/MDVO Surface Adapter Box



Interface Plate, Flush

Interface Plates combine flexibility and ease of use in work area installations. They are designed to accept the EZ-MDVO and GigaFlex UTP modules as well as all the MDVO Multimedia Modules. The Interface Plates are available in Single gang and can accept up to 6 modules. They also have labeling capabilities using built-in labeling windows. The faceplates can be attached to standard electrical boxes or wall-mounting hardware for flush-mount installations. The faceplates can also fit over the Interface Adapter Boxes for surface mount installations.

Interface/MDVO Surface Adapter Box

The **Interface/MDVO Surface Adapter Box** allows surface mounting of Interface Plates as well as MDVO Flush and Angled entry faceplates. The box can be mounted on any flat surface or can be attached to standard electrical boxes or wall-mounting hardware for additional storage space.

Description	Belden Part Number
-------------	--------------------

Workstation Outlets

Interface Plate	
Flush, 2-port, Gray	AX101431
Flush, 2-port, Almond	AX101432
Flush, 2-port, White	AX101433
Flush, 2-port, Black	AX101434
Flush, 2-port, Ivory	AX102582
Flush, 4-port, Gray	AX101435
Flush, 4-port, Almond	AX101436
Flush, 4-port, White	AX101437
Flush, 4-port, Black	AX101438
Flush, 4-port, Ivory	AX102583
Flush, 6-port, Gray	AX101439
Flush, 6-port, Almond	AX101440
Flush, 6-port, White	AX101441
Flush, 6-port, Black	AX101442
Flush, 6-port, Ivory	AX102584

Interface/MDVO Surface Adapter Box	
Single Gang, Gray	AX101474
Single Gang, Almond	AX101475
Single Gang, White	AX101476
Single Gang, Black	AX101477
Single Gang, Ivory	AX102589

These products are in the process of being assessed for RoHS compliance. Please check our Web Site for the most current RoHS status.

Workstation Outlets

MDVO Adapters

A0645271 MDVO Side Entry Box, shown here with modules



AX100311 MDVO 106 Adapter, 4-port, shown here with modules

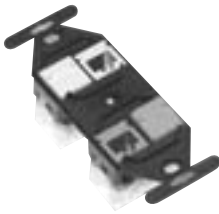

A0409654 MDVO Deco Adapter, shown here with modules



AX100925 MDVO Modular Furniture Adapter, 4-port, shown here with modules



MDVO Adapters

All MDVO Adapters are compatible with GigaFlex, EZ-MDVO and MDVO Multimedia Modules.

The MDVO Side Entry Box can be easily mounted directly on the wall, as well as on modular furniture panels, baseboards and utility poles. The compact size of the box allows secure installation in confined areas such as behind a desk or underneath a workstation.

The MDVO 106 Adapters are designed for installations using standard NEMA electrical-style faceplates also referred to as 106-type or duplex wall plates.

The MDVO Deco Adapter is designed for installations using Decora style wall plates.

MDVO Modular Furniture Adapters are the ideal outlet adapters for open office furniture applications. They can be snapped into any standard opening, in modular furniture settings.

Description	Belden Part Number
-------------	--------------------

Workstation Outlets

MDVO Adapters	
MDVO Side Entry Box, 2-port, Gray	A0645271
MDVO Side Entry Box, 2-port, Almond	A0645272
MDVO Side Entry Box, 2-port, White	A0645273
MDVO Side Entry Box, 2-port, Black	A0645274
MDVO Side Entry Box, 2-port, Ivory	AX102590
MDVO 106 Adapter, 2-port, Gray	AX100304
MDVO 106 Adapter, 2-port, Almond	AX100305
MDVO 106 Adapter, 2-port, White	AX100306
MDVO 106 Adapter, 2-port, Black	AX100307
MDVO 106 Adapter, 2-port, Ivory	AX102591
MDVO 106 Adapter, 4-port, Gray	AX100308
MDVO 106 Adapter, 4-port, Almond	AX100309
MDVO 106 Adapter, 4-port, White	AX100310
MDVO 106 Adapter, 4-port, Black	AX100311
MDVO 106 Adapter, 4-port, Ivory	AX102592
MDVO Deco Adapter, 3-port, Gray	A0409651
MDVO Deco Adapter, 3-port, Almond	A0409652
MDVO Deco Adapter, 3-port, White	A0409653
MDVO Deco Adapter, 3-port, Black	A0409654
MDVO Deco Adapter, 3-port, Ivory	AX102593
MDVO Modular Furniture Adapter, 3-port, Gray	A0407071
MDVO Modular Furniture Adapter, 3-port, Almond	A0407072
MDVO Modular Furniture Adapter, 3-port, White	A0407073
MDVO Modular Furniture Adapter, 3-port, Black	A0407074
MDVO Modular Furniture Adapter, 3-port, Ivory	AX102648
MDVO Modular Furniture Adapter, 4-port, Gray	AX100925
MDVO Modular Furniture Adapter, 4-port, Almond	AX100926
MDVO Modular Furniture Adapter, 4-port, White	AX100927
MDVO Modular Furniture Adapter, 4-port, Black	AX100928
MDVO Modular Furniture Adapter, 4-port, Ivory	AX102594

These products are in the process of being assessed for RoHS compliance. Please check our Web Site for the most current RoHS status.

Workstation Outlets

Stainless Steel Faceplate

AX102007 2-port Stainless Steel SG Faceplate
Keystone-style, shown here with modules



AX102012 6-port Stainless Steel DG Faceplate
Keystone-style, shown here with modules



Stainless Steel Faceplate

Belden's **Stainless Steel Faceplates** are ideal for labs, sanitary, medical, and harsh environment type applications.

They are designed to accept Keystone-style modules. The Stainless Steel Faceplates are available as Single Gang and Double Gang, and can accept up to 12 modules. A studded version designed to support a wall phone is also offered. Stainless Steel Faceplates can be attached to standard NEMA type outlet boxes or wall-mounting hardware for flush-mount installation. Stainless Steel Faceplates are cULus Listed.

Please note : For use only with Keystone-style modules such as GigaFlex PS6+, GigaFlex PS5E and EZ-MDVO Modules.

Description	Belden Part Number
-------------	--------------------

Workstation Outlets

Stainless Steel Faceplate	
1-Port Stainless Steel SG Faceplate - Keystone-style studded for Phone	AX102005
1-Port Stainless Steel SG Faceplate - Keystone-style	AX102006
2-Port Stainless Steel SG Faceplate - Keystone-style	AX102007
3-Port Stainless Steel SG Faceplate - Keystone-style	AX102008
4-Port Stainless Steel SG Faceplate - Keystone-style	AX102009
6-Port Stainless Steel SG Faceplate - Keystone-style	AX102010
4-Port Stainless Steel DG Faceplate - Keystone-style	AX102011
6-Port Stainless Steel DG Faceplate - Keystone-style	AX102012
12-Port Stainless Steel DG Faceplate - Keystone-style	AX102013

These products are in the process of being assessed for RoHS compliance. Please check our Web Site for the most current RoHS status.

Workstation Outlets

European Style Faceplates and Inserts

AX101372-73 European “6C” Style Faceplates and AX101377-75-76 European “6C” Inserts

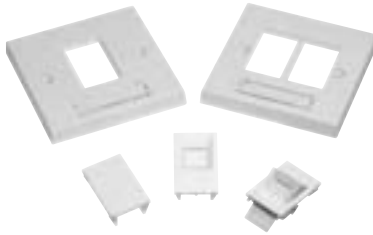

European “6C” Style Faceplate

The European “6C” Style faceplates and Inserts are designed to accept the GigaFlex and EZ-MDVO UTP Modules.

They include a shutter to protect the module against dust and other contaminants.

French Style Faceplate

The French Style Faceplates are designed to accept the EZ-MDVO and GigaFlex UTP modules as well as all the MDVO multimedia modules. The faceplates can be attached to standard 45 mm x 45 mm boxes or mounting hardware for flush-mount installations.

AX101413-14 French Style Faceplates

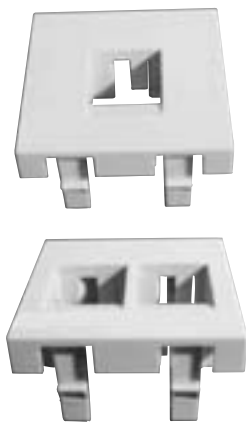

AX101415-16 French Style Faceplates

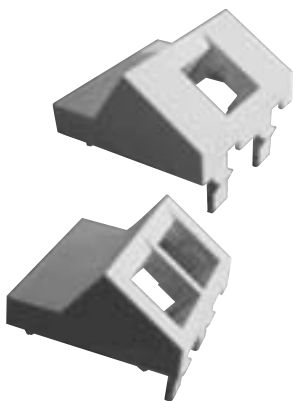

Description	Belden Part Number
-------------	--------------------

Workstation Outlets

European “6C” Style Faceplate	
European “6C” Style Faceplate, Single Gang, Single Aperture, White	AX101372
European “6C” Style Faceplate, Single Gang, Dual Aperture, White	AX101373
European “6C” Style Faceplate, Double Gang, Quad Aperture, White	AX101374
European “6C” Shuttered Module Holder, 1-port, Flush, White	AX101375
European “6C” Shuttered Module Holder, 1-port, Angled, White	AX101376
European “6C” Blank Insert, White	AX101377
French Style Faceplate	
1-port, Flush, White	AX101413
2-port, Flush, White	AX101414
1-port, Angled, White	AX101415
2-port, Angled, White	AX101416

These products are in the process of being assessed for RoHS compliance. Please check our Web Site for the most current RoHS status.

Workstation Outlets

MDVO Multimedia Outlet Boxes, Multi-User Outlet Boxes and Multi-User Adapter Strips

A0643205 MDVO Multimedia Outlet Box, shown here as terminated

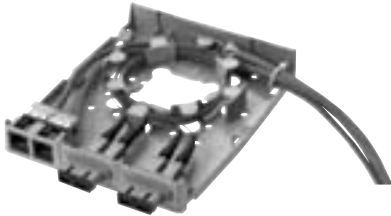

AX100222 Multi-User Outlet Box, shown here with modules



AX100223 MDVO Adapter Strip, 12-port



MDVO Multimedia Outlet Box

The **MDVO Multimedia Outlet Box** brings unique versatility for multimedia work area installations. The box design provides cable management and helps maintain cable bend radius. The outlet box's low profile design and side-entry offers better protection for patch cords. The outlet box can accept up to six EZ-MDVO, GigaFlex or MDVO Multimedia Modules or three SC Duplex adapters.

The MDVO Multimedia Outlet Box can be mounted directly on the wall or attached to standard electrical boxes. Included with the MDVO Multimedia box are three SC Duplex Mounting bezels and three MDVO Adapters.

Multi-User Outlet Box

The **Multi-User Outlet Box** is a versatile box that can be used in many different applications. The outlet box can accommodate up to 24 connections of any type, UTP, fiber or coax. The outlet box is ideal for use as a multi-user telecommunications assembly, or simply as a high-density multimedia telecommunications outlet. The Multi-User Outlet Box can also be used as a wall mounted patch panel in confined areas, such as shallow rooms and cabinets.

Multi-User Adapter Strips

The Multi-User Outlet Box design allows for mixed media installations with a choice of connection strips. The box can accept either one or two 12-port **MDVO Adapter Strips, PS5E HD Connector Module Strips (BIX or 110)**, or a combination of both for a maximum of 24 connections.

Description	Belden Part Number
Workstation Outlets	
MDVO Multimedia Outlet Box	
6-port, Gray	A0643205
6-port, Almond	A0643206
6-port, White	A0643207
6-port, Black	A0643208
6-port, Ivory	AX102595
Multi-User Outlet Box	
24-port, Gray	AX100219
24-port, Almond	AX100220
24-port, White	AX100221
24-port, Black	AX100222
Multi-User Adapter Strips	
MDVO Adapter Strip, 12-port, Empty, Black	AX100223
PS5E HD-BIX Connector Module Strip, Universal Wiring 12-port, T568A/B	AX100224
PS5E HD-110 Connector Module Strip, Universal Wiring 12-port, T568B/A	AX100494

These products are in the process of being assessed for RoHS compliance. Please check our Web Site for the most current RoHS status.

Workstation Outlets

MDVO Multimedia Modules

A0407005 MDVO SC Fiber Module

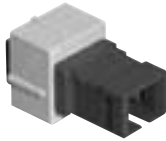

A0649254 SC Duplex Adapter



A0407010 MDVO ST Compatible Fiber Module



AX101467 MDVO MTRJ Fiber Module



A0406997 MDVO BNC Coaxial Module



A0406999 MDVO Video F Coaxial Module



MDVO Multimedia Module

MDVO Multimedia Modules address audio/video and fiber applications. Fiber modules are available for LC Duplex, SC Simplex, ST Compatible multimode and MT-RJ multimode & single-mode connections. The SC Duplex Adapter is a fiber adapter sleeve with flanges that mounts into the SC Duplex mounting bezel (included in the MDVO Multimedia Outlet box). Audio/video modules are available for SVHS, RCA, BNC and Video F connections.

Description	Belden Part Number				
	Gray	Almond	White	Black	Ivory

Workstation Outlets

MDVO Multimedia Module					
LC Duplex Multimode	AX102209	AX102210	AX102211	AX102619	
LC Duplex Single-mode	AX102213	AX102214	AX102215	AX102216	
SC Simplex, Multimode	A0407003	A0407004	A0407005	A0407006	AX102596
SC Duplex Adapter, Multimode	A0649254				
ST Compatible, Multimode	A0407007	A0407008	A0407009	A0407010	AX102597
MT-RJ, Multimode	AX101467				
MT-RJ, Single-mode, Blue	AX101466				

Description	Belden Part Number				
	Gray Holder	Almond Holder	White Holder	Black Holder	Ivory Holder
Coaxial, BNC	A0406995	A0406996	A0406997	A0406998	AX102598
Coaxial, Video F	A0406999	A0407000	A0407001	A0407002	AX102599
RCA, feedthru, White insert	AX101823	AX101824	AX101825	AX101826	AX102601
RCA, feedthru, Yellow insert	AX101827	AX101828	AX101829	AX101830	AX102602
RCA, feedthru, Red insert	AX101831	AX101832	AX101833	AX101834	AX102603
RCA, feedthru, Black insert	AX101835	AX101836	AX101837	AX101838	AX102604
SVHS, feedthrough	AX101839	AX101840	AX101841	AX101842	AX102605
3.5mm Stereo	AX102624	AX102625	AX102626	AX102627	AX102628

Custom multimedia connectors are also available, please contact Customer Service for more details.

These products are in the process of being assessed for RoHS compliance. Please check our Web Site for the most current RoHS status.

Workstation Outlets

PS5E BIX DVO Outlets and Double Gang Outlet

PS5E BIX DVO Outlets



AX100601 PS5E BIX DVO Module



AX100613 DVO Faceplate, 3-port



AX100640 DVO Faceplate, 4-port



PS5E BIX DVO Outlet

The **PS5E BIX DVO Workstation Outlets** are robust and installer-friendly products, combining punch-down connectors with standard modular jacks. The outlet's unique, completely enclosed housing protects the connectors and allows the wires to be front-terminated on BIX Insulation Displacement Connectors (IDC). The snap-on cover plate allows easy access and eliminates visible mounting screws.

PS5E BIX DVO Workstation Outlets offer headroom over the Category 5e cabling standard.

PS5E BIX DVO Double Gang Outlet

PS5E BIX DVO Double Gang Workstation Outlets offer high capacity outlet configuration options in the work area. They are created by combining **PS5E BIX DVO Connector Modules and DVO Double Gang Faceplates**.

Each faceplate can accept up to two connector modules. A color-coded icon labeling system can be used to tag each outlet port and simplify network management.

Description	Belden Part Number		
	1-Port	2-Port	4-Port

Workstation Outlets

PS5E BIX DVO Outlets			
Surface, T568A-ISDN, Gray	AX100382	AX100390	AX100398
Surface, T568A-ISDN, Almond	AX100383	AX100391	AX100399
Surface, T568A-ISDN, White	AX100384	AX100392	AX100400
Surface, T568A-ISDN, Black	AX100385	AX100393	AX100401
Surface, T568B-ALT, Gray	AX100386	AX100394	AX100402
Surface, T568B-ALT, Almond	AX100387	AX100395	AX100403
Surface, T568B-ALT, White	AX100388	AX100396	AX100404
Surface, T568B-ALT, Black	AX100389	AX100397	AX100405
Flush, T568A-ISDN, Gray	AX100334	AX100342	AX100350
Flush, T568A-ISDN, Almond	AX100335	AX100343	AX100351
Flush, T568A-ISDN, White	AX100336	AX100344	AX100352
Flush, T568A-ISDN, Black	AX100337	AX100345	AX100353
Flush, T568B-ALT, Gray	AX100338	AX100346	AX100354
Flush, T568B-ALT, Almond	AX100339	AX100347	AX100355
Flush, T568B-ALT, White	AX100340	AX100348	AX100356
Flush, T568B-ALT, Black	AX100341	AX100349	AX100357

Description	Belden Part Number			
	T568A-ISDN	T568B-ALT	3-Port	4-Port

PS5E BIX DVO Double Gang Outlet				
PS5E BIX DVO Connector Module, Flush, 1-port, Gray	AX100601	AX100604		
PS5E BIX DVO Connector Module, Flush, 2-port, Gray	AX100602	AX100605		
DVO Double Gang Faceplate, Flush, Gray			AX100613	AX100640
DVO Double Gang Faceplate, Flush, Almond			AX100614	AX100641
DVO Double Gang Faceplate, Flush, White			AX100615	AX100642
DVO Double Gang Faceplate, Flush, Black			AX100616	AX100643

These products are in the process of being assessed for RoHS compliance. Please check our Web Site for the most current RoHS status.



Workstation Outlets

Outlet Accessories

A0405538 MDVO Blank Insert



MDVO Blank Insert

MDVO Blank Inserts can be used in any MediaFlex outlets, Interface plates, MDVO faceplates, adapters or boxes to fill in unused ports.

AX102022 Colored Bezel



Colored Bezel

The **Colored Bezels** are plastic inserts that fit over the face of GigaFlex and EZ-MDVO Modules to modify their color. They are particularly useful in installations where the churn rate is high and color identification of outlets is critical (ex.: segmented network with security levels). They also contribute to simplifying the management of the cabling infrastructure by using only one color of module for Moves, Adds and Changes (MACs).

AX100196 ID Tab



ID Tab

ID Tabs are color-coded identification caps that can be inserted over the GigaFlex and EZ-MDVO Modules. The ID tabs are available as blank, data or voice coded. They are available in eleven colors to facilitate identification and to match modern office decor.

The flexible identification cap also acts as a protective cover eliminating exposure to dust and other contaminants when the module is not in use.

Description	Belden Part Number
-------------	--------------------

Workstation Outlets

MDVO Blank Insert

Gray	A0405536
Almond	A0405537
White	A0405538
Black	A0405539
Electric White	AX102607
Ivory	AX102600

Colored Bezel

Gray	AX102014
Almond	AX102015
White	AX102016
Black	AX102017
Orange	AX102018
Red	AX102019
Yellow	AX102020
Green	AX102021
Blue	AX102022
Purple	AX102023
Brown	AX102024
Ivory	AX102606

Description	Belden Part Number		
	Blank	Data	Voice

ID Tab

Gray	AX100182	AX100193	AX100204
Almond	AX100183	AX100194	AX100205
White	AX100184	AX100195	AX100206
Black	AX100185	AX100196	AX100207
Orange	AX100186	AX100197	AX100208
Red	AX100187	AX100198	AX100209
Yellow	AX100188	AX100199	AX100210
Green	AX100189	AX100200	AX100211
Blue	AX100190	AX100201	AX100212
Purple	AX100191	AX100202	AX100213
Brown	AX100192	AX100203	AX100214

These products are in the process of being assessed for RoHS compliance. Please check our Web Site for the most current RoHS status.

Workstation Outlets

Tools

AX100749 GigaFlex Connecting Tool



GigaFlex Connecting Tool

The **GigaFlex Connecting Tool** is a no-impact connecting tool used to terminate cables, pigtails or cross-connect wires on any GigaFlex Module or 110 product. The GigaFlex Tool is a spring-activated hand tool. A single forward movement will seat the wire into the IDC clip and cut off the excess wire. The tool will terminate 22, 24 and 26-AWG plastic insulated solid copper conductors.

1797B Cable Preparation Tool



Bonded-Pair Cable Preparation Tool

The **Bonded-Pair Cable Preparation Tool** makes it faster and easier to prepare cables for connector termination. This tool is ideal for use with Belden's DataTwist® 350, MediaTwist®, and DataTwist® 600e Bonded-Pair cables, providing special features that help separate twisted pairs. It can also be used to prepare any nonbonded-pair cable for installation.

AX101852 Termination Station



Termination Station

The **Termination Station** is an ergonomically designed holder that provides stability to the GigaFlex Module during the termination process. The station has pockets with locking features that steadily holds either MDVO-style or Keystone-style GigaFlex Modules or MediaFlex Inserts during pair placement and wire termination. Cable retainers on each end of the station will secure and hold cables during the pair placements process. The flat bottom surface will provide the required stability to safely terminate the modules. The tool is made of very durable plastic and its low profile makes it an easy tool to use and carry.

Outlet Release Tool

The **Outlet Release Tool** is a very convenient tool for servicing the MediaFlex and Interface outlets. Its bent tip allows for easy front removal of MediaFlex inserts, especially when used in Angled Entry plates. It is also very useful to extract GigaFlex Modules from miscellaneous mounting hardware and to remove the protective cap for GigaFlex Module re-termination.

AX101185 Outlet Release Tool



Description	Belden Part Number
-------------	--------------------

Workstation Outlets

Tools	
GigaFlex Connecting Tool	AX100749
Bonded-Pair Cable Preparation Tool	1797B
Termination Station	AX101852
Outlet Release Tool	AX101185

These products are in the process of being assessed for RoHS compliance. Please check our Web Site for the most current RoHS status.

Modular Cords

GigaFlex PS6+ Modular Cords and GigaFlex PS6+ Bonded Modular Cords Enhanced Category 6

AX350061 GigaFlex PS6+ Modular Cord



GigaFlex PS6+ Modular Cord

The **GigaFlex PS6+ Modular Cords** are 4-pair 23 AWG UTP modular cords designed for use with the Belden IBDN Systems 2400 and 4800LX, providing channel bandwidths of 250 MHz and 300 MHz, respectively. The GigaFlex PS6+ Modular Cords have been designed to provide a mated-connection performance that exceeds the Category 6 requirements.

The GigaFlex PS6+ Modular Cord's patented design, with a very small footprint, makes them fully compatible with any of the highest density hubs with RJ45 jack connections.

Description	Belden Part Number					
	Blue	White	Gray	Green	Red	Yellow

Modular Cords

GigaFlex PS6+ Modular Cord, CMR 4-pair, 23 AWG solid, T568A/B-T568A/B						
0.6 m (2 ft.)	AX350037	AX350043	AX350049	AX350055	AX350061	AX350067
1.2 m (4 ft.)	AX350038	AX350044	AX350050	AX350056	AX350062	AX350068
2.1 m (7 ft.)	AX350039	AX350045	AX350051	AX350057	AX350063	AX350069
3.0 m (10 ft.)	AX350040	AX350046	AX350052	AX350058	AX350064	AX350070
4.6 m (15 ft.)	AX350041	AX350047	AX350053	AX350059	AX350065	AX350071
7.6 m (25 ft.)	AX350042	AX350048	AX350054	AX350060	AX350066	AX350072
4-pair, 23 AWG solid, T568A/B-open						
4.6 m (15 ft.)	AX350160					
7.6 m (25 ft.)	AX350161					
10.6 m (35 ft.)	AX350162					
15.0 m (50 ft.)	AX350163					

These products are in the process of being assessed for RoHS compliance. Please check our Web Site for the most current RoHS status.

AX380014 GigaFlex PS6+ Bonded Modular Cord



GigaFlex PS6+ Bonded Modular Cords

The **GigaFlex PS6+ Bonded Modular Cords** are 4-pair 24 AWG Bonded-Pair UTP modular cords designed for use with the Belden IBDN Systems 2400 and 4800LX, providing channel bandwidths of 250 MHz and 300 MHz, respectively. The GigaFlex PS6+ Bonded Modular Cords have been designed to provide a mated-connection performance that exceeds the Category 6 requirements.

The GigaFlex PS6+ Bonded Modular Cord's patented design, with a very small footprint, makes them fully compatible with the highest density hubs, with any RJ45 jack connections. The special cord design offers increased stability in crosstalk and impedance performance to support the many moves, adds and changes performed in the lifetime of the system.

Description	Belden Part Number			
	Blue	Gray	White	Yellow

Modular Cords

GigaFlex PS6+ Bonded Mod. Cord, CMR, 4-pr, Bonded 24 AWG solid, T568A/B-T568A/B				
1.2 m (4 ft.)	AX380014	AX380026	AX380050	AX380056
2.1 m (7 ft.)	AX380015	AX380027	AX380051	AX380057
3.0 m (10 ft.)	AX380016	AX380028	AX380052	AX380058
4.6 m (15 ft.)	AX380017	AX380029	AX380053	AX380059
7.6 m (25 ft.)	AX380018	AX380030	AX380054	AX380060

These products are in the process of being assessed for RoHS compliance. Please check our Web Site for the most current RoHS status.

Modular Cords

GigaFlex PS5E Modular Cords and GigaFlex PS5E VoIP Cords Category 5E

AX350013 GigaFlex PS5E Modular Cord



GigaFlex PS5E Modular Cord

The **GigaFlex PS5E Modular Cords** are 4-pair 24 AWG UTP modular cords that are designed for use with the Belden IBDN Plus Cabling System and the Belden IBDN System 1200 providing channel bandwidths of 100 MHz and 160 MHz, respectively.

The GigaFlex PS5E Modular Cord's patented design features a very small footprint, making them fully compatible with the highest density hubs which use RJ45 jack connections. The GigaFlex PS5E Modular Cords have been designed to provide a mated-connection performance that exceeds the Category 5e standard.

Description	Belden Part Number					
	Blue	White	Gray	Green	Red	Yellow

Modular Cords

GigaFlex PS5E Mod. Cord, CMR 4-pr, 24 AWG stranded, T568A/B-T568A/B						
0.6 m (2 ft.)	AX350001	AX350007	AX350013	AX350019	AX350025	AX350031
1.2 m (4 ft.)	AX350002	AX350008	AX350014	AX350020	AX350026	AX350032
2.1 m (7 ft.)	AX350003	AX350009	AX350015	AX350021	AX350027	AX350033
3.0 m (10 ft.)	AX350004	AX350010	AX350016	AX350022	AX350028	AX350034
4.6 m (15 ft.)	AX350005	AX350011	AX350017	AX350023	AX350029	AX350035
7.6 m (25 ft.)	AX350006	AX350012	AX350018	AX350024	AX350030	AX350036

AX330015 GigaFlex PS5E VoIP Modular Cord



VoIP Modular Cord features very short body RJ 45 phone connector on other end

GigaFlex PS5E VoIP Modular Cords

The **GigaFlex PS5E VoIP Modular Cords** are 4-pair 24 AWG UTP modular cords that are designed for use with the Belden IBDN Plus Cabling System and the Belden IBDN System 1200 providing channel bandwidths of 100 MHz and 160 MHz, respectively. The GigaFlex PS5E VoIP Modular Cord is designed for use with VoIP phones that can not accommodate standard booted patch cords which would make the phone unstable or difficult to wall mount. The GigaFlex PS5E VoIP Modular Cord is designed with a regular booted RJ 45 plug on one end (at the wall) and a bootless very short body RJ 45 plug on the other end (at the phone). The GigaFlex PS5E VoIP Modular Cords meet all the enhanced Category 5 modular cord requirements as per the Category 5e standard, and are completely backward compatible with Category 5 jacks. The GigaFlex PS5E VoIP Modular Cords have been designed to provide a mated-connection performance that exceeds the Category 5e standard. The GigaFlex PS5E VoIP Modular Cord product line encompass CMR-rated cords.

Description	Belden Part Number					
	Blue	White	Gray	Green	Red	Yellow

Modular Cords

GigaFlex PS5E VoIP Mod.Cord, CMR, 4-pair, 24 AWG stranded,T568A/B-T568A/B						
0.6 m (2 ft.)	AX330013	AX330049	AX330025	AX330019	AX330043	AX330055
1.2 m (4 ft.)	AX330014	AX330050	AX330026	AX330020	AX330044	AX330056
2.1 m (7 ft.)	AX330015	AX330051	AX330027	AX330021	AX330045	AX330057
3.0 m (10 ft.)	AX330016	AX330052	AX330028	AX330022	AX330046	AX330058
4.6 m (15 ft.)	AX330017	AX330053	AX330029	AX330023	AX330047	AX330059
7.6 m (25 ft.)	AX330018	AX330054	AX330030	AX330024	AX330048	AX330060

These products are in the process of being assessed for RoHS compliance. Please check our Web Site for the most current RoHS status.

Modular Cords

Category 5e Modular Cords

Category 5e Modular Cord



Category 5e Modular Cord

Category 5e Modular Cords are made of plenum and riser rated 24 AWG patch cable.

Description	Belden Part Number					
	Blue	Green	Red	White	Yellow	Gray

Modular Cords

Cat. 5e Modular Cord, CMR, 4-pair, 24 AWG stranded, T568A/B-T568A/B

0.6 m (2 ft.)	23518027	23528027	23538027	23548027	23568027	23598027
1.2 m (4 ft.)	23518047	23528047	23538047	23548047	23568047	23598047
2.1 m (7 ft.)	23518077	23528077	23538077	23548077	23568077	23598077
3.0 m (10 ft.)	23518107	23528107	23538107	23548107	23568107	23598107
4.6 m (15 ft.)	23518157	23528157	23538157	23548157	23568157	23598157
7.6 m (25 ft.)	23518257	23528257	23538257	23548257	23568257	23598257

Cat. 5e X-Over Cord, 4-pair, 24 AWG stranded, T568A-T568B X-Over

2.1 m (7 ft.)	23598074
4.6 m (15 ft.)	23598154
7.6 m (25 ft.)	23598254

Description	Belden Part Number	
	CMR	CMP

Modular Cords

Cat. 5e Modular Cord, Gray, 4-pair, 24 AWG solid, T568A/B-T568A/B

2.1 m (7 ft.)	23498077	23338077
3.0 m (10 ft.)	23498107	23398107
7.6 m (25 ft.)	23498257	23398257
15.0 m (50 ft.)	23498507	23398507
20.1 m (66 ft.)	23498667	23398667

Cat. 5e Pigtails, Gray, 4-pair, 24 AWG solid, T568A/B-open

3.0 m (10 ft.)	23498105	—
4.6 m (15 ft.)	23498155	—
7.6 m (25 ft.)	23498255	23398255
10.6 m (35 ft.)	23498355	23398355
15.0 m (50 ft.)	23498505	23398505

These products are in the process of being assessed for RoHS compliance. Please check our Web Site for the most current RoHS status.

Network Connectivity Products

Media Converters, Transceivers & Hubs and Network Tester

Media Converters

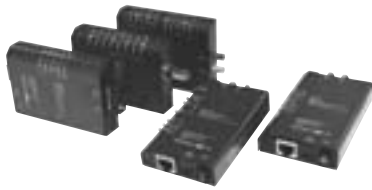

AX-1912 Media Converter Rack

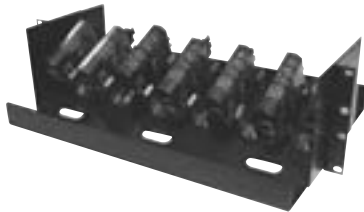

AX050, 70 and 80 Transceivers and AX-509 Ethernet Hub

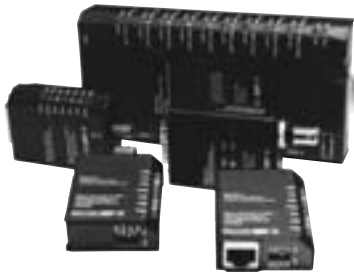

AX-110BT Realtime 10/100 Base-TX Ethernet Network Test Unit



Media Converters for Ethernet and Fast Ethernet

Media Converters enable the connection of dissimilar network cabling types, while maintaining the same network speed. A legacy Thinnet segment can be connected to a 10Base-T Hub or switch port with a AX-200 Converter or, link two different 10Base-T networks together over a multimode fiber optic link with a pair of AX-270s. Connect a legacy Thinnet segment over fiber with the AX-280 converter. The AX-5270 can be used for interbuilding links or attached to a fiber backbone.

Transceivers and Ethernet Hubs

The AX-50, 70 and 80 Transceivers enable the connection of a legacy AUI port to 10Base-T, Thinnet, or Fiber Optic media. The transceiver is powered from the host and requires no external power supply.

The AX-509 Ethernet Hub has an AUI port which accepts UTP, Fiber Optic or BNC transceivers. Specified for use by many U.S. Government Agencies. Includes a 110v/12v power supply.

Realtime 10/100 Base-TX Ethernet Network Test Unit

The AX-110BT Realtime 10/100 Base-TX Ethernet Network Test Unit is a cost effective way to quickly determine a network's operating condition. Plug the unit's patch cord into the tester then into any open RJ-45 jack in an office, cubicle or conference room. Immediately see if the jack is a live network node capable of either 100 Mb/s or 10 Mb/s. Next check patch cord continuity and polarity. Connect the downlink to a PC to check NIC card link, speed and full or half duplex capabilities. Connect the uplink to a hub or switch port to verify link and speed.

Description	Belden Part Number
Network Connectivity Products	
Media Converter	
10Base-T/10Base2, RJ-45 to BNC	AX-200
10Base-T/10Base-FL, RJ-45 to ST-Compatible fiber connectors	AX-270
10Base2/10Base-FL, BNC to ST-Compatible fiber connectors	AX-280
100Base-TX/100Base-FX, SC-Compatible fiber connectors	AX-5270SC
100Base-TX/100Base-FX, ST-Compatible fiber connectors	AX-5270ST
Media Converter Rack	
Holds up to 12 converters and multi lead power supplies, 19 in. rack-mount ready	AX-1912-MCR
Power Supply, 4-lead 110v/12v, powers up to 4 converters	AX-270P4U
Power Supply, 8-lead 110v/12v, powers up to 8 converters	AX-270P8U
Transceivers and Ethernet Hubs	
UTP Transceiver, 10Base-T, AUI to RJ-45, side port	AX-50
UTP Transceiver, 10Base-T, AUI to RJ-45, rear port	AX-50R
Fiber Transceiver, 10Base-FL, AUI to ST-Compatible	AX-70
Thinnet Transceiver, 10Base2, AUI to BNC	AX-80
Ethernet Hub with 8 RJ-45 10Base-T ports and 1 AUI port	AX-509
Network Tester	
Realtime 10/100 Base-TX Ethernet Network Test Unit	AX-110BT

These products are in the process of being assessed for RoHS compliance. Please check our Web Site for the most current RoHS status.

Line Protection and Bonding & Grounding

IDC 4-pair Protector Modules, PPCI Ground Wires, Bond Clamp and Accessories

AX100826 Cat-5e, 4-pair Protector

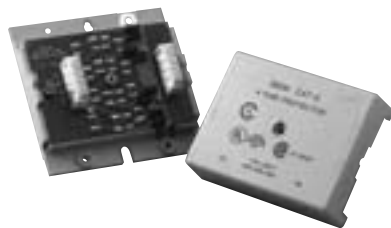

IDC 4-pair Protector Module

The **IDC 4-pair Protector Module** is a high-performance Category 5e, solid-state protection for Local Area Networks. Protects sensitive electronic workstations, network equipment, and cables from damage caused by transient voltage surges. Provides 100% protection with easy-to-install BIX or 110 IDC termination in a convenient 4-pair module.

Description	Belden Part Number
Line Protection	
IDC 4-pair Protector Module	
IDC Protector Module, Category 5e, 4-pair, BIX Protector, 1/pack	AX100826
IDC Protector Module, Category 5e, 4-pair, 110 Protector, 1/pack	AX100827

PPCI Ground Wire

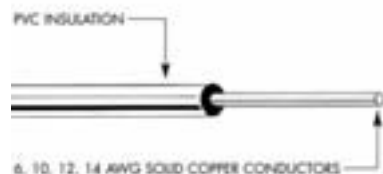

PPCI Ground Wire

PPCI Ground Wire consists of 6, 10, 12 and 14 AWG Solid annealed copper conductors individually insulated with polyvinyl chloride compound.

X9905753 Bond Clamp



Bond Clamp

The **Bond Clamps** are used to attach the cable shield to the ground via Ground Wire. They are recommended for use with Riser Cables and Outside Plant Cables. The bond clamps consist of heavy plates and a securing nut with an integral spring washer. The plates are curved to conform to the contours of the cable. The upper plate has “teeth” which penetrate the polyethylene cable jacket and align with the perforations in the lower plate. The lower plate has burred perforations that penetrate into the metallic sheath of the cable.

Accessories

A **Six-position Ground Bracket** is used to terminate and ground up to 5 cable sheaths. The sixth position on the bracket is used to provide the ground return to the Distribution Terminal and is not available to ground a cable.

Two **Ground Wire Clips** on each side of the ground wire are required to ground one cable.

AX100226 Six-position Ground Bracket



Description	Belden Part Number
-------------	--------------------

Bonding & Grounding

PPCI Ground Wire	
PPCI Ground Wire, 6 AWG, Black, 75 m (246 ft.), Coil	22214348
PPCI Ground Wire, 10 AWG, Black, 50 m (164 ft.), Coil	22214500
PPCI Ground Wire, 12 AWG, Almond, 50 m (164 ft.), Coil	22214700
PPCI Ground Wire, 14 AWG, Olive Gray, 75 m (246 ft.), Coil	22214900

X9908359 6 AWG Ground Wire Clip



Bond Clamp	
Bond Clamp, QCF1A 19 mm (0.75 in.) cable and above	X9905753
Bond Clamp, QCF2A 19 mm (0.75 in.) cable and below	X9905754
Accessories	
Bond Clamp Accessories, Six-position Ground Bracket	AX100226
Bond Clamp Accessories, 6 AWG Ground Wire Clip	X9908359

These products are in the process of being assessed for RoHS compliance. Please check our Web Site for the most current RoHS status.

DataTwist® 600e UTP Cable

TIA/EIA-568-B.2-1, Category 6
Enhanced Category 6 Bonded-Pair Cables

Certified System Cable

Description	Part No.	UL NEC/ C(UL) CEC Type	No. of Pairs	Standard Lengths		Standard Unit Wt.		Nominal OD		Max. DCR (Ω/100m)	Max. DCR Unbal. (%)	Max. Cap. Unbal. (pF/100m)	Freq. (MHz)	Max. Atten. (dB/100m)	Min. PSUM NEXT (dB)	Min. PSUM ACR (dB/100m)	Min. PSUM ELFEXT (dB/100m)	Input Imped. (Ω)	Min. RL (dB)
				Ft.	m	Lbs.	kg	Inch	mm										

23 AWG Bonded-Pairs Solid Bare Copper Conductors • Patented E-Spline Center Member • Rip Cord • See Color Code Chart (below)

Non-Plenum • Polyolefin Insulation • PVC Jacket (Available in Red, Orange, Yellow, Green, Blue, Black, White or Gray)

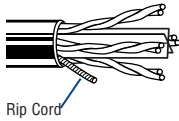
	7851A	NEC: CMR CEC: CMR	4	1000	304.8	38.0	17.2	.227	5.77	8.2	3.0	65.6	1	1.9	80.3	78.5	70.8	100±12	20.0							
				A-1000	A-304.8	47.0	21.3	x	x											10	5.7	65.3	59.6	50.8	100±12	25.0
								.315	8.00											31.25	10.2	57.9	47.7	40.9	100±15	25.0
																				62.5	14.7	53.4	38.7	34.9	100±15	25.0
																				100	18.9	50.3	31.4	30.8	100±15	25.0
																				155	23.9	47.5	23.5	27.0	100±15	22.8
																				200	27.5	45.8	18.3	24.8	100±15	21.7
																				250	31.2	44.3	13.2	22.8	100±20	20.5
																				350	37.7	40.2	4.5	19.9	100±22	19.8
																				400	40.6	39.3	0.6	18.8	100±22	19.5
																				500	46.2	37.8	>0*	16.8	100±22	18.4
																				550	48.8	37.2	—	16.0	100±22	18.0
																				600	51.4	36.6	—	15.2	100±22	17.6

Third party verified to TIA/EIA-568-B.2-1, Category 6
U.S. Patents 5,606,151; 5,734,126; 5,789,711 and 6,297,454-B1
Jacket sequentially marked at 2 ft. intervals. Features Descending Length Marking.

Non-Plenum • Polyolefin Insulation • Gray Haloarrest® Jacket

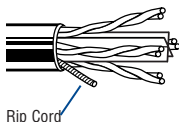
	7851NH	NEC: CMP CEC: CMP	4	1000	304.8	39.0	17.7	.241	6.12	8.2	3.0	65.6	1	1.9	80.3	78.5	70.8	100±12	20.0							
				A-1000	A-304.8	48.0	21.8	x	x											10	5.7	65.3	59.6	50.8	100±12	25.0
								.329	8.36											31.25	10.2	57.9	47.7	40.9	100±15	25.0
																				62.5	14.7	53.4	38.7	34.9	100±15	25.0
																				100	18.9	50.3	31.4	30.8	100±15	25.0
																				155	23.9	47.5	23.5	27.0	100±15	22.8
																				200	27.5	45.8	18.3	24.8	100±15	21.7
																				250	31.2	44.3	13.2	22.8	100±20	20.5
																				350	37.7	40.2	4.5	19.9	100±22	19.8
																				400	40.6	39.3	0.6	18.8	100±22	19.5
																				500	46.2	37.8	>0*	16.8	100±22	18.4
																				550	48.8	37.2	—	16.0	100±22	18.0
																				600	51.4	36.6	—	15.2	100±22	17.6

Third party verified to TIA/EIA-568-B.2-1, Category 6
U.S. Patents 5,606,151; 5,734,126; 5,789,711 and 6,297,454-B1
Jacket sequentially marked at 1 meter intervals. Features Descending Length Marking.

Plenum • FEP Teflon® Insulation • Flamarrest® Jacket (Available in Red, Orange, Yellow, Green, Blue, Black, White or Gray)

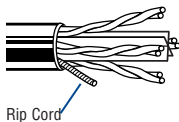
	7852A	NEC: CMP CEC: CMP	4	1000	304.8	40.0	18.1	.218	5.54	8.2	3.0	65.6	1	1.9	80.3	78.5	70.8	100±12	20.0							
				A-1000 †	A-304.8	49.0	22.2	x	x											10	5.7	65.3	59.6	50.8	100±12	25.0
								.290	7.37											31.25	10.2	57.9	47.7	40.9	100±15	25.0
																				62.5	14.7	53.4	38.7	34.9	100±15	25.0
																				100	18.9	50.3	31.4	30.8	100±15	25.0
																				155	23.9	47.5	23.5	27.0	100±15	22.8
																				200	27.5	45.8	18.3	24.8	100±15	21.7
																				250	31.2	44.3	13.2	22.8	100±20	20.5
																				350	37.7	40.2	4.5	19.9	100±22	19.8
																				400	40.6	39.3	0.6	18.8	100±22	19.5
																				500	46.2	37.8	>0*	16.8	100±22	18.4
																				550	48.8	37.2	—	16.0	100±22	18.0
																				600	51.4	36.6	—	15.2	100±22	17.6

† A-1000 ft. put-up not available in Red.

Third party verified to TIA/EIA-568-B.2-1, Category 6
U.S. Patents 5,606,151; 5,734,126; 5,789,711 and 6,297,454-B1
Jacket sequentially marked at 2 ft. intervals. Features descending Length marking.

ACR = Attenuation Crosstalk Ratio • DCR = DC Resistance • ELFEXT = Equal Level Far-end Crosstalk • NEXT = Near-end Crosstalk • PSUM = Power Sum • RL = Return Loss • UTP = Unshielded Twisted Pair(s)

*PSUM ACR >0 is guaranteed to 460 MHz

 Not RoHS compliant at time of printing. Please check with Belden Technical Support for current compliance information at 1-800-BELDEN-1.

DataTwist 600e: Beyond Category 6

Belden® DataTwist 600e data cable is a revolutionary UTP cable engineered specifically to perform well beyond Category 6 standards. While Category 6 cable is specified only to 250 MHz, DataTwist 600e is the only Cat 6 UTP cable in the industry fully characterized with guaranteed performance to 600 MHz. So users have far more headroom to compensate for unforeseen factors that can inhibit the performance of a cabling system today...and protection of their technology investment for the future.

Handy Cable Preparation Tool Speeds Installation Of Bonded-Pair Cables

You know the high performance benefits of using data cables featuring Belden's unique Bonded-Pair technology. The Belden Cable Preparation Tool (1797B) now makes it faster and easier than ever to prepare cables for connector termination providing special features that help separate twisted pairs. The Cable Preparation Tool is packed with every spool of DataTwist 600e. See page 15.40 for more information.



Color Codes: DataTwist 600e

Pair No.	Color Combination
1	White/Blue Stripe & Blue
2	White/Orange Stripe & Orange
3	White/Green Stripe & Green
4	White/Brown Stripe & Brown

Teflon is a DuPont trademark.

GigaFlex 4800LX Cable Series

ANSI/TIA/EIA-568-B.2-1, Category 6

Enhanced Category 6 Nonbonded-pair Cables

Certified System Cable

Description	Part No.	UL NEC/ C(UL) CEC Type	No. of Pairs	Standard Lengths		Standard Unit Wt.		Nominal OD		Max. DCR (Ω/100m)	Max. DCR Unbal. (%)	Max. Cap. Unbal. (pF/100m)	Freq. (MHz)	Max. Atten. (dB/100m)	Min. PSUM NEXT (dB)	Min. PSUM ACR (dB/100m)	Min. PSUM ELFEXT (dB/100m)	Input Imped. (Ω)	Min. RL (dB)
				Ft.	m	Lbs.	kg	Inch	mm										

23 AWG Solid Bare Copper Conductors • Twisted Pairs • Central Cross Web Filler • Rip Cord • See Color Code Chart (below)

Non-Plenum • Polyolefin Insulation • PVC Jacket

White - Reel	24586385	NEC:	4	1000	304.8	29.1	13.2	.245	6.22	6.6	3.0	50	0.772	1.7	80.0	78.3	74.0	100±12	—
Blue - Reel	24586985	CMR											1.0	1.8	78.3	76.5	71.8	100±12	20.0
		CEC:											4.0	3.4	69.3	65.9	59.7	100±12	23.0
		CMR											8.0	4.8	64.8	60.0	53.7	100±12	25.0
													10.0	5.3	63.3	58.0	51.8	100±12	25.0
													16.0	6.8	60.3	53.5	47.7	100±12	25.0
													20.0	7.6	58.8	51.2	45.7	100±12	25.0
													25.0	8.5	57.3	48.8	43.8	100±15	24.6
													31.25	9.6	55.9	46.3	41.9	100±15	24.2
													62.5	13.8	51.4	37.6	35.8	100±15	23.0
			100.0	17.8	48.3	30.5	31.8	100±15	22.1										
			200.0	26.2	43.8	17.6	25.7	100±15	20.9										
			250.0	29.7	42.3	12.6	23.8	100±20	20.5										
			300.0	33.0	41.2	8.2	22.2	100±20	20.2										
			350.0	36.1	40.2	4.1	20.9	100±22	19.9										
			400.0	39.0	39.3	0.3	19.7	100±22	19.7										
			450.0 [Ⓟ]	41.8	38.5	-3.3	18.7	100±22	19.5										
			500.0 [Ⓟ]	44.5	37.8	-6.7	17.8	100±22	19.3										
			550.0 [Ⓟ]	47.1	37.2	-9.9	16.9	100±22	19.1										

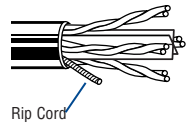

Jacket sequentially marked at 2 ft. intervals.
Featuring Descending Length Marking.
Third party verified to TIA/EIA-568-B.2-1, Category 6

Non-Plenum • Polyolefin Insulation - LSZH Polymer Alloy

Purple - Reel	24588085	NEC:	4	1000	304.8	31.1	14.1	.246	6.10	6.6	3.0	50	0.772	1.7	80.0	78.3	74.0	100±12	—
		CMR											1.0	1.8	78.3	76.5	71.8	100±12	20.0
		CEC:											4.0	3.4	69.3	65.9	59.7	100±12	23.0
		CMR											8.0	4.8	64.8	60.0	53.7	100±12	25.0
													10.0	5.3	63.3	58.0	51.8	100±12	25.0
													16.0	6.8	60.3	53.5	47.7	100±12	25.0
													20.0	7.6	58.8	51.2	45.7	100±12	25.0
													25.0	8.5	57.3	48.8	43.8	100±15	24.6
													31.25	9.6	55.9	46.3	41.9	100±15	24.2
													62.5	13.8	51.4	37.6	35.8	100±15	23.0
			100.0	17.8	48.3	30.5	31.8	100±15	22.1										
			200.0	26.2	43.8	17.6	25.7	100±15	20.9										
			250.0	29.7	42.3	12.6	23.8	100±20	20.5										
			300.0	33.0	41.2	8.2	22.2	100±20	20.2										
			350.0	36.1	40.2	4.1	20.9	100±22	19.9										
			400.0	39.0	39.3	0.3	19.7	100±22	19.7										
			450.0 [Ⓟ]	41.8	38.5	-3.3	18.7	100±22	19.5										
			500.0 [Ⓟ]	44.5	37.8	-6.7	17.8	100±22	19.3										
			550.0 [Ⓟ]	47.1	37.2	-9.9	16.9	100±22	19.1										

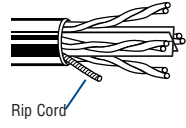

Jacket sequentially marked at 2 ft. intervals.
Featuring Descending Length Marking.
Third party verified to TIA/EIA-568-B.2-1, Category 6

Plenum • 100% FEP Insulation - LSZH Polymer Alloy

White - Reel	24587385	NEC:	4	1000	304.8	30.7	13.9	.229	5.81	6.6	3.0	50	0.772	1.7	80.0	78.3	74.0	100±12	—
Blue - Reel	24587985	CMP											1.0	1.8	78.3	76.5	71.8	100±12	20.0
		CEC:											4.0	3.4	69.3	65.9	59.7	100±12	23.0
		CMP											8.0	4.8	64.8	60.0	53.7	100±12	25.0
													10.0	5.3	63.3	58.0	51.8	100±12	25.0
													16.0	6.8	60.3	53.5	47.7	100±12	25.0
													20.0	7.6	58.8	51.2	45.7	100±12	25.0
													25.0	8.5	57.3	48.8	43.8	100±15	24.6
													31.25	9.6	55.9	46.3	41.9	100±15	24.2
													62.5	13.8	51.4	37.6	35.8	100±15	23.0
			100.0	17.8	48.3	30.5	31.8	100±15	22.1										
			200.0	26.2	43.8	17.6	25.7	100±15	20.9										
			250.0	29.7	42.3	12.6	23.8	100±20	20.5										
			300.0	33.0	41.2	8.2	22.2	100±20	20.2										
			350.0	36.1	40.2	4.1	20.9	100±22	19.9										
			400.0	39.0	39.3	0.3	19.7	100±22	19.7										
			450.0 [Ⓟ]	41.8	38.5	-3.3	18.7	100±22	19.5										
			500.0 [Ⓟ]	44.5	37.8	-6.7	17.8	100±22	19.3										
			550.0 [Ⓟ]	47.1	37.2	-9.9	16.9	100±22	19.1										

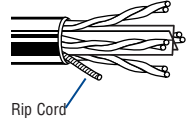

Jacket sequentially marked at 2 ft. intervals.
Featuring Descending Length Marking.
Third party verified to TIA/EIA-568-B.2-1, Category 6

ACR = Attenuation Crosstalk Ratio • DCR = DC Resistance • ELFEXT = Equal Level Far-end Crosstalk • NEXT = Near-end Crosstalk • PSUM = Power Sum • RL = Return Loss • UTP = Unshielded Twisted Pair(s)
Ⓟ Values provided for information only.

Color Codes: GigaFlex 4800LX

Pair No.	Color Combination
1	White/Blue Stripe & Blue
2	White/Orange Stripe & Orange
3	White/Green Stripe & Green
4	White/Brown Stripe & Brown

MediaTwist® UTP Cable

TIA/EIA-568-B.2-1, Category 6

Enhanced Category 6 Bonded-Pair Cables

Certified System Cable

Description	Part No.	UL NEC/ C(UL) CEC Type	No. of Pairs	Standard Lengths		Standard Unit Wt.		Nominal OD		Max. DCR (Ω/100m)	Max. DCR Unbal. (%)	Max. Cap. Unbal. (pF/100m)	Freq. (MHz)	Max. Atten. (dB/100m)	Min. PSUM NEXT (dB)	Min. PSUM ACR (dB/100m)	Min. PSUM ELFEXT (dB/100m)	Input Imped. (Ω)	Min. RL (dB)
				Ft.	m	Lbs.	kg	Inch	mm										

23 AWG Bonded-Pairs Solid Bare Copper Conductor • Rip Cord • See Color Code Chart (below)

Non-Plenum • Polyolefin Insulation • PVC Jacket (Blue, Red, Yellow, Orange, Green, Gold, Purple, White, Black or Gray)

Part No.	UL NEC/ C(UL) CEC Type	No. of Pairs	Standard Lengths (Ft./m)	Standard Unit Wt. (Lbs./kg)	Nominal OD (Inch/mm)	Max. DCR (Ω/100m)	Max. DCR Unbal. (%)	Max. Cap. Unbal. (pF/100m)	Freq. (MHz)	Max. Atten. (dB/100m)	Min. PSUM NEXT (dB)	Min. PSUM ACR (dB/100m)	Min. PSUM ELFEXT (dB/100m)	Input Imped. (Ω)	Min. RL (dB)									
1872A	NEC:	4	1000 A-1000*	304.8 A-304.8	37.0 16.8	.365 x	9.27 x	9.0	3.0	49.2	1	1.9	72.3	70	64.8	100±12	20.0							
	CMR																	4	3.7	63.3	59	52.8	100±12	23.0
	CEC:																	8	5.3	58.8	53	46.7	100±12	24.5
	CMR																	10	5.9	57.3	51	44.8	100±12	25.0
																		16	7.5	54.3	46	40.7	100±12	25.0
																		25	9.5	51.4	42	36.8	100±15	24.3
																		31.25	10.6	49.9	39	34.9	100±15	23.6
																		62.5	15.4	45.4	30	28.9	100±15	21.5
																		100	19.8	42.3	25	24.8	100±15	21.0
																		155	25.1	39.5	14	20.9	100±15	21.0
																		200	29.0	37.8	10	18.8	100±15	21.0
																		250	32.8	36.3	3	16.8	100±20	18.0
	300	35.2	35.2	>0	15.2	100±20	18.0																	
	350	39.8	34.2	—	13.9	100±22	17.0																	
	400 [†]	43.0	—	—	—	100±32	14.0																	
	500 [†]	49.0	—	—	—	100±32	14.0																	

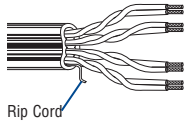

*A-1000 ft. put-up not available in Black.
 Features Descending Length Marking.
 Jacket sequentially marked at 2 ft. intervals.
 U.S. Patents 5,606,151; 5,734,126; 5,821,467
 Third party verified to TIA/EIA-568-B.2-1, Category 6

Plenum • FEP Teflon® Insulation • Flamarrest® Jacket (Blue, Natural, Gray, Red, Yellow, Orange, Green, Gold, Purple, White or Black)

Part No.	UL NEC/ C(UL) CEC Type	No. of Pairs	Standard Lengths (Ft./m)	Standard Unit Wt. (Lbs./kg)	Nominal OD (Inch/mm)	Max. DCR (Ω/100m)	Max. DCR Unbal. (%)	Max. Cap. Unbal. (pF/100m)	Freq. (MHz)	Max. Atten. (dB/100m)	Min. PSUM NEXT (dB)	Min. PSUM ACR (dB/100m)	Min. PSUM ELFEXT (dB/100m)	Input Imped. (Ω)	Min. RL (dB)									
1874A	NEC:	4	1000 A-1000**	304.8 A-304.8	37.0 17.2	.365 x	9.27 x	9.0	3.0	49.2	1	1.9	72.3	70	64.8	100±12	20.0							
	CMR																	4	3.7	63.3	59	52.8	100±12	23.0
	CEC:																	8	5.3	58.8	53	46.7	100±12	24.5
	CMR																	10	5.9	57.3	51	44.8	100±12	25.0
																		16	7.5	54.3	46	40.7	100±12	25.0
																		25	9.5	51.4	42	36.8	100±15	24.3
																		31.25	10.6	49.9	39	34.9	100±15	23.6
																		62.5	15.4	45.4	30	28.9	100±15	21.5
																		100	19.8	42.3	25	24.8	100±15	21.0
																		155	25.1	39.5	14	20.9	100±15	21.0
																		200	29.0	37.8	10	18.8	100±15	21.0
																		250	32.8	36.3	3	16.8	100±20	18.0
	300	35.2	35.2	>0	15.2	100±20	18.0																	
	350	39.8	34.2	—	13.9	100±22	17.0																	
	400 [†]	43.0	—	—	—	100±32	14.0																	
	500 [†]	49.0	—	—	—	100±32	14.0																	

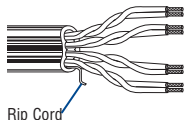

**A-1000 ft. put-up not available in Black.
 Features Descending Length Marking.
 Jacket sequentially marked at 2 ft. intervals.
 U.S. Patents 5,606,151; 5,734,126; 5,821,467
 Third party verified to TIA/EIA-568-B.2-1, Category 6

ACR = Attenuation Crosstalk Ratio • DCR = DC Resistance • ELFEXT = Equal Level Far-end Crosstalk • NEXT = Near-end Crosstalk • PSUM = Power Sum • RL = Return Loss • UTP = Unshielded Twisted Pair(s)
[†]Values provided for information only.

⚠ Not RoHS compliant at time of printing. Please check with Belden Technical Support for current compliance information at 1-800-BELDEN-1.

Color Codes: MediaTwist

Pair No.	Color Combination
1	White/Blue Stripe & Blue
2	White/Orange Stripe & Orange
3	White/Green Stripe & Green
4	White/Brown Stripe & Brown

Teflon is a DuPont trademark.

Get the Bonded-Pairs Cable Preparation Tool
 See page 15.40 for details.
 (Part No. 1797B)

GigaFlex 2400 Cable Series

TIA/EIA-568-B.2-1, Category 6

Enhanced Category 6 Nonbonded-pair Cables

Certified System Cable

Description	Part No.	UL NEC/ C(UL) CEC Type	No. of Pairs	Standard Lengths		Standard Unit Wt.		Nominal OD		Max. DCR (Ω/100m)	Max. DCR Unbal. (%)	Max. Cap. Unbal. (pF/100m)	Freq. (MHz)	Max. Atten. (dB/100m)	Min. PSUM NEXT (dB)	Min. PSUM ACR (dB/100m)	Min. PSUM ELFEXT (dB/100m)	Input Imped. (Ω)	Min. RL (dB)
				Ft.	m	Lbs.	kg	Inch	mm										

24 AWG Solid Bare Copper Conductors • Twisted Pairs • Rip Cord • See Color Code Chart (below)

Non-Plenum • Polyolefin Insulation • PVC Jacket																			
White, Reel-in-Box	24566315	NEC:	4	1000	304.8	26.0	11.8	.214	5.44	9.38	5.0	330	0.772	1.8	75.0	73.2	70.0	100±15	19.7
Blue, Reel-in-Box	24566915	CMR											1.0	2.0	73.3	71.3	67.8	100±15	20.0
White, Reel	24566345	CEC:											4.0	3.7	64.3	60.6	55.8	100±15	23.0
Blue, Reel	24566945	CMR											8.0	5.2	59.8	54.6	49.7	100±15	24.5
													10.0	5.8	58.3	52.5	47.8	100±15	25.0
													16.0	7.4	55.2	47.9	43.7	100±15	25.0
													20.0	8.3	53.8	45.5	41.8	100±15	25.0
													25.0	9.3	52.3	43.1	39.8	100±15	24.3
													31.25	10.4	50.9	40.5	37.9	100±15	23.6
													62.5	15.0	46.4	31.4	31.9	100±15	21.5
													100.0	19.3	43.3	24.0	27.8	100±15	20.1
													200.0	28.3	38.8	10.5	21.8	100±22	18.0
													250.0	32.1	37.3	5.3	19.8	100±32	17.3
													300.0 [Ⓢ]	35.6	36.1	0.5	18.3	100±32	16.8
													350.0 [Ⓢ]	38.9	35.1	-3.7	16.9	100±32	16.3
													400.0 [Ⓢ]	42.0	34.3	-7.7	15.8	100±32	15.9
													450.0 [Ⓢ]	45.0	33.5	-11.5	14.7	100±32	15.5

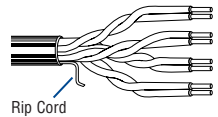

Jacket sequentially marked at 2 ft. intervals.
Featuring Descending Length Marking.
Third party verified to TIA/EIA-568-B.2-1, Category 6

Non-Plenum • Polyolefin Insulation - LSZH Polymer Alloy																			
Purple, Reel	24568005	NEC:	4	1000	304.8	28.0	12.7	.214	5.44	9.38	5.0	330	0.772	1.8	75.0	73.2	70.0	100±15	19.7
		CMR											1.0	2.0	73.3	71.3	67.8	100±15	20.0
		CEC:											4.0	3.7	64.3	60.6	55.8	100±15	23.0
		CMR											8.0	5.2	59.8	54.6	49.7	100±15	24.5
													10.0	5.8	58.3	52.5	47.8	100±15	25.0
													16.0	7.4	55.2	47.9	43.7	100±15	25.0
													20.0	8.3	53.8	45.5	41.8	100±15	25.0
													25.0	9.3	52.3	43.1	39.8	100±15	24.3
													31.25	10.4	50.9	40.5	37.9	100±15	23.6
													62.5	15.0	46.4	31.4	31.9	100±15	21.5
													100.0	19.3	43.3	24.0	27.8	100±15	20.1
													200.0	28.3	38.8	10.5	21.8	100±22	18.0
													250.0	32.1	37.3	5.3	19.8	100±32	17.3
													300.0 [Ⓢ]	35.6	36.1	0.5	18.3	100±32	16.8
													350.0 [Ⓢ]	38.9	35.1	-3.7	16.9	100±32	16.3
													400.0 [Ⓢ]	42.0	34.3	-7.7	15.8	100±32	15.9
													450.0 [Ⓢ]	45.0	33.5	-11.5	14.7	100±32	15.5

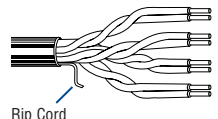

Jacket sequentially marked at 2 ft. intervals.
Featuring Descending Length Marking.
Third party verified to TIA/EIA-568-B.2-1, Category 6

Plenum • 100% FEP Insulation • Low-Smoke PVC Jacket																			
White, Reel-in-Box	24567315	NEC:	4	1000	304.8	24.0	10.9	.210	5.33	9.38	5.0	330	0.772	1.8	75.0	73.2	70.0	100±15	19.7
Blue, Reel-in-Box	24567915	CMP											1.0	2.0	73.3	71.3	67.8	100±15	20.0
White, Reel	24567345	CEC:											4.0	3.7	64.3	60.6	55.8	100±15	23.0
Blue, Reel	24567945	CMP											8.0	5.2	59.8	54.6	49.7	100±15	24.5
													10.0	5.8	58.3	52.5	47.8	100±15	25.0
													16.0	7.4	55.2	47.9	43.7	100±15	25.0
													20.0	8.3	53.8	45.5	41.8	100±15	25.0
													25.0	9.3	52.3	43.1	39.8	100±15	24.3
													31.25	10.4	50.9	40.5	37.9	100±15	23.6
													62.5	15.0	46.4	31.4	31.9	100±15	21.5
													100.0	19.3	43.3	24.0	27.8	100±15	20.1
													200.0	28.3	38.8	10.5	21.8	100±22	18.0
													250.0	32.1	37.3	5.3	19.8	100±32	17.3
													300.0 [Ⓢ]	35.6	36.1	0.5	18.3	100±32	16.8
													350.0 [Ⓢ]	38.9	35.1	-3.7	16.9	100±32	16.3
													400.0 [Ⓢ]	42.0	34.3	-7.7	15.8	100±32	15.9
													450.0 [Ⓢ]	45.0	33.5	-11.5	14.7	100±32	15.5

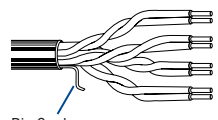

Jacket sequentially marked at 2 ft. intervals.
Featuring Descending Length Marking.
Third party verified to TIA/EIA-568-B.2-1, Category 6

ACR = Attenuation Crosstalk Ratio • DCR = DC Resistance • ELFEXT = Equal Level Far-end Crosstalk • NEXT = Near-end Crosstalk • PSUM = Power Sum • RL = Return Loss • UTP = Unshielded Twisted Pair(s)
*Values provided for information only.

Color Codes: GigaFlex 2400

Pair No.	Color Combination
1	White/Blue Stripe & Blue
2	White/Orange Stripe & Orange
3	White/Green Stripe & Green
4	White/Brown Stripe & Brown



DataTwist® 350 UTP Cable

TIA/EIA-568-B.2, Category 5e

Enhanced Category 5e Bonded-Pair Cables

Certified System Cable

Description	Part No.	UL NEC/ C(UL) CEC Type	No. of Pairs	Standard Lengths		Standard Unit Wt.		Nominal OD		Max. DCR (Ω/100m)	Max. DCR Unbal. (%)	Max. Cap. Unbal. (pF/100m)	Freq. (MHz)	Max. Atten. (dB/100m)	Min. PSUM NEXT (dB)	Min. PSUM ACR (dB/100m)	Min. PSUM ELFEXT (dB/100m)	Input Imped. (Ω)	Min. RL (dB)
				Ft.	m	Lbs.	kg	Inch	mm										

24 AWG Bonded-Pairs Solid Bare Copper Conductors • Rip Cord • See Color Code Chart (below)

Non-Plenum • Polyolefin Insulation • PVC Jacket (Red, Orange, White, Black, Yellow, Green, Blue, Purple, Light Gray or Gray)

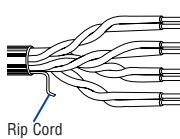
	1700A	NEC:	4	U-1000	U-304.8	22.0	10.0	.200	5.08	9.0	3.0	66.0	1	2.0	65.3	63.3	60.8	100±12	20.0							
		CM		1000 †	304.8	22.0	10.0													4	4.0	56.3	52.3	48.8	100±12	23.0
		CEC:		1640 †	500.0	36.1	16.4													8	5.7	51.8	46.1	42.7	100±12	24.5
		CM		3000 †	914.4	63.0	28.6													10	6.4	50.3	43.9	40.8	100±12	25.0
				3280 †	1000.0	72.2	32.8													16	8.1	47.3	39.1	36.7	100±12	25.0
																				25	10.3	44.3	34.1	32.8	100±15	24.3
																				31.25	11.6	42.9	31.3	30.9	100±15	23.6
																				62.5	16.8	38.4	21.6	24.9	100±15	21.5
																				100	21.7	35.3	17.1	20.8	100±15	20.1
																				155	27.7	32.5	4.7	16.9	100±18	19.0
							200	32.0	30.8	3.0	14.7	100±18	19.0													
							250	36.4	29.3	—	12.8	100±20	18.0													
							350	44.3	27.2	—	9.9	100±22	17.0													
	1702A*	NEC:	2x4	1000 *	304.8	45.0	20.4	.200	5.08																	
		CM		1640 *	500.0	73.8	33.5			x	x															
		CEC:							.415	10.54																
		CM																								
	1700R	NEC:		4	U-1000 ††	U-304.8	22.0	10.0	.204	5.18																
		CMR			1000 ††	304.8	22.0	10.0																		
		CEC:			3000 ††	914.4	63.0	28.6																		
		CMR																								

*1702A is Siamese version of 1700A and is available in Blue or Light Gray only.

†1000 ft. put-up not available in Gray. 3000 ft. put-up available in Red, Blue, White or Lt. Gray only. 1640 ft. available in Lt. Gray or Blue only. 3280 ft. available in Lt. Gray only.

††1700R is not available in Black nor Medium Gray. 3000 ft. put-up available in Red, Blue, Purple, White or Light Gray only.

Third party verified to TIA/EIA-568-B.2, Category 5e

Jacket sequentially marked at 2 ft. intervals. Features Descending Length Marking. • U.S. Patents 5,606,151 and 5,734,126

Plenum • FEP Teflon® Insulation • Flamarrest® Jacket (Available in Red, Orange, Gray, Yellow, Green, Blue, Purple, Natural or Black)

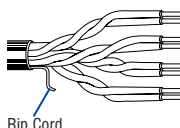
	1701A	NEC:	4	U-1000	U-304.8	23.0	10.5	.195	4.95	9.0	3.0	66.0	1	2.0	65.3	63.3	60.8	100±12	20.0							
		CMP		1000	304.8	24.0	10.9													4	4.0	56.3	52.3	48.8	100±12	23.0
		CEC:		3000 †	914.4	69.0	31.3													8	5.7	51.8	46.1	42.7	100±12	24.5
		CMP																		10	6.4	50.3	43.9	40.8	100±12	25.0
																				16	8.1	47.3	39.1	36.7	100±12	25.0
																				25	10.3	44.3	34.1	32.8	100±15	24.3
																				31.25	11.6	42.9	31.3	30.9	100±15	23.6
																				62.5	16.8	38.4	21.6	24.9	100±15	21.5
																				100	21.7	35.3	17.1	20.8	100±15	20.1
																				155	27.7	32.5	4.7	16.9	100±18	19.0
							200	32.0	30.8	3.0	14.7	100±20	19.0													
							250	36.4	29.3	—	12.8	100±20	18.0													
							350	44.3	27.2	—	9.9	100±22	17.0													
	1703A**	NEC:	2x4	1000 ††	304.8	46.0	20.9	.195	4.95																	
		CMP							x	x																
		CEC:							.405	10.29																
		CMP																								

**1703A is Siamese version of 1701A.

†3000 ft. put-up available in Blue or Natural only.

††1000 ft. put-up available in Blue or Natural only.

Third party verified to TIA/EIA-568-B.2, Category 5e

Jacket sequentially marked at 2 ft. intervals. Features Descending Length Marking. • U.S. Patents 5,606,151 and 5,734,126

Plenum • FEP Teflon Insulation • FEP Jacket (Available in Blue or White)

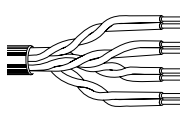
	1701LC	NEC:	4	U-1000	U-304.8	23.0	10.5	.187	4.75	9.0	3.0	66.0	1	2.0	65.3	63.3	60.8	100±12	20.0							
		Limited Combustible FHC 25/50		1000	304.8	24.0	10.9													4	4.0	56.3	52.3	48.8	100±12	23.0
		CMP																		8	5.7	51.8	46.1	42.7	100±12	24.5
		CEC:																		10	6.4	50.3	43.9	40.8	100±12	25.0
		CMP																		16	8.1	47.3	39.1	36.7	100±12	25.0
																				25	10.3	44.3	34.1	32.8	100±15	24.3
																				31.25	11.6	42.9	31.3	30.9	100±15	23.6
																				62.5	16.8	38.4	21.6	24.9	100±15	21.5
																				100	21.7	35.3	17.1	20.8	100±15	20.1
																				155	27.7	32.5	4.7	16.9	100±18	19.0
							200	32.0	30.8	3.0	14.7	100±20	19.0													
							250	36.4	29.3	—	12.8	100±20	18.0													
							350	44.3	27.2	—	9.9	100±22	17.0													

1701LC does not have a rip cord.

Third party verified to TIA/EIA-568-B.2, Category 5e

Jacket sequentially marked at 2 ft. intervals. Features Descending Length Marking. • U.S. Patents 5,606,151 and 5,734,126

ACR = Attenuation Crosstalk Ratio • DCR = DC Resistance • ELFEXT = Equal Level Far-end Crosstalk • NEXT = Near-end Crosstalk • PSUM = Power Sum • RL = Return Loss • UTP = Unshielded Twisted Pair(s)

Color Codes: DataTwist 350

Pair No.	Color Combination
1	White/Blue Stripe & Blue
2	White/Orange Stripe & Orange
3	White/Green Stripe & Green
4	White/Brown Stripe & Brown

Get the Bonded-Pairs Cable Preparation Tool

See page 15.40 for details.

(Part No. 1797B)



Teflon is a DuPont trademark.



GigaFlex 1200 Cable Series

TIA/EIA-568-B.2, Category 5E
Enhanced Category 5 Nonbonded-pair Cables

Certified System Cable

Description	Part No.	UL NEC/ C(UL) CEC Type	No. of Pairs	Standard Lengths		Standard Unit Wt.		Nominal OD		Max. DCR (Ω/100m)	Max. DCR Unbal. (%)	Max. Cap. Unbal. (pF/100m)	Freq. (MHz)	Max. Atten. (dB/100m)	Min. PSUM NEXT (dB)	Min. PSUM ACR (dB/100m)	Min. PSUM ELFEXT (dB/100m)	Input Imped. (Ω)	Min. RL (dB)
				Ft.	m	Lbs.	kg	Inch	mm										

24 AWG Solid Bare Copper Conductors • Twisted Pairs • Rip Cord • See Color Code Chart (below)

Non-Plenum • Polyolefin Insulation • PVC Jacket																			
White, Box	24570166	NEC:	4	1000	304.8	24.0	10.9	.186	4.72	9.38	5.0	330	0.772	1.8	69.0	67.2	63.0	100±15	—
Blue, Box	24570161	CMR											1.0	2.0	67.3	65.3	60.8	100±15	20.0
White, Reel	24570460	CEC:											4.0	4.0	58.3	54.3	48.7	100±15	23.0
Blue, Reel	24570452	CMR											8.0	5.7	53.8	48.1	42.7	100±15	24.5
													10.0	6.3	52.3	46.0	40.8	100±15	25.0
													16.0	8.1	49.3	41.2	36.7	100±15	25.0
													20.0	9.1	47.8	38.7	34.7	100±15	25.0
													25.0	10.2	46.3	36.1	32.8	100±15	24.3
													31.25	11.5	44.9	33.4	30.9	100±15	23.6
													62.5	16.7	40.4	23.7	24.8	100±15	21.5
													100.0	21.6	37.3	15.7	20.8	100±15	20.1
													200.0 [▲]	31.9	32.8	0.9	14.7	100±22	18.0
													250.0 [▲]	36.3	31.3	-4.9	12.8	100±22	17.3
													300.0 [▲]	40.3	30.2	-10.2	11.2	100±22	16.8
													350.0 [▲]	44.2	29.2	-15.0	9.9	100±22	16.3

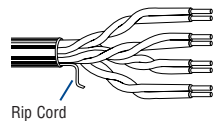

Jacket sequentially marked at 2 ft. intervals.
Featuring Descending Length Marking.
Third party verified to TIA/EIA-568-B.2, Category 5e

Non-Plenum • Polyolefin Insulation - LSZH Polymer Alloy																			
Purple	24570157	NEC:	4	1000	304.8	25.0	11.3	.198	5.03	9.38	5.0	330	0.772	1.8	69.0	67.2	63.0	100±15	—
		CMR											1.0	2.0	67.3	65.3	60.8	100±15	20.0
		CEC:											4.0	4.0	58.3	54.3	48.7	100±15	23.0
		CMR											8.0	5.7	53.8	48.1	42.7	100±15	24.5
													10.0	6.3	52.3	46.0	40.8	100±15	25.0
													16.0	8.1	49.3	41.2	36.7	100±15	25.0
													20.0	9.1	47.8	38.7	34.7	100±15	25.0
													25.0	10.2	46.3	36.1	32.8	100±15	24.3
													31.25	11.5	44.9	33.4	30.9	100±15	23.6
													62.5	16.7	40.4	23.7	24.8	100±15	21.5
													100.0	21.6	37.3	15.7	20.8	100±15	20.1
													200.0 [▲]	31.9	32.8	0.9	14.7	100±22	18.0
													250.0 [▲]	36.3	31.3	-4.9	12.8	100±22	17.3
													300.0 [▲]	40.3	30.2	-10.2	11.2	100±22	16.8
													350.0 [▲]	44.2	29.2	-15.0	9.9	100±22	16.3

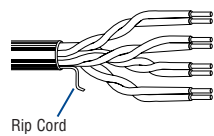

Jacket sequentially marked at 2 ft. intervals.
Featuring Descending Length Marking.
Third party verified to TIA/EIA-568-B.2, Category 5e

Plenum • Dual Insulation: Polyolefin / FEP • Low-Smoke PVC Jacket																			
White, Box	24570810	NEC:	4	1000	304.8	22.0	9.98	.188	4.78	9.38	5.0	330	0.772	1.8	69.0	67.2	63.0	100±15	—
Blue, Box	24570800	CMP											1.0	2.0	67.3	65.3	60.8	100±15	20.0
White, Reel	24570808	CEC:											4.0	4.0	58.3	54.3	48.7	100±15	23.0
Blue, Reel	24570812	CMP											8.0	5.7	53.8	48.1	42.7	100±15	24.5
													10.0	6.3	52.3	46.0	40.8	100±15	25.0
													16.0	8.1	49.3	41.2	36.7	100±15	25.0
													20.0	9.1	47.8	38.7	34.7	100±15	25.0
													25.0	10.2	46.3	36.1	32.8	100±15	24.3
													31.25	11.5	44.9	33.4	30.9	100±15	23.6
													62.5	16.7	40.4	23.7	24.8	100±15	21.5
													100.0	21.6	37.3	15.7	20.8	100±15	20.1
													200.0 [▲]	31.9	32.8	0.9	14.7	100±22	18.0
													250.0 [▲]	36.3	31.3	-4.9	12.8	100±22	17.3
													300.0 [▲]	40.3	30.2	-10.2	11.2	100±22	16.8
													350.0 [▲]	44.2	29.2	-15.0	9.9	100±22	16.3

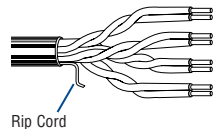

Jacket sequentially marked at 2 ft. intervals.
Featuring Descending Length Marking.
Third party verified to TIA/EIA-568-B.2, Category 5e

ACR = Attenuation Crosstalk Ratio • DCR = DC Resistance • ELFEXT = Equal Level Far-end Crosstalk • NEXT = Near-end Crosstalk • PSUM = Power Sum • RL = Return Loss • UTP = Unshielded Twisted Pair(s)

[▲] Values provided for information only.

Color Codes: GigaFlex 1200

Pair No.	Color Combination
1	White/Blue Stripe & Blue
2	White/Orange Stripe & Orange
3	White/Green Stripe & Green
4	White/Brown Stripe & Brown



DataTwist® 6 UTP Cable

TIA/EIA-568-B.2-1, Category 6 Nonbonded-Pair Cables

Description	Part No.	UL NEC/ C(UL) CEC Type	No. of Pairs	Standard Lengths		Standard Unit Wt.		Nominal OD		Max. DCR (Ω/100m)	Max. DCR Unbal. (%)	Max. Cap. Unbal. (pF/100m)	Freq. (MHz)	Max. Atten. (dB/100m)	Min. PSUM NEXT (dB)	Min. PSUM ACR (dB/100m)	Min. PSUM ELFEXT (dB/100m)	Input Imped. (Ω)	Min. RL (dB)
				Ft.	m	Lbs.	kg	Inch	mm										

23 AWG Solid Bare Copper Conductors • Twisted Pairs • Central Rod Filler • Rip Cord • See Color Code Chart (below)

Non-Plenum • Polyolefin Insulation • PVC Jacket (Available in Red, Orange, Yellow, Green, Blue, Purple, Gray, White or Black)

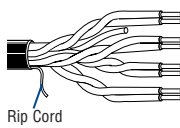
 <p>Rip Cord</p>	7881A	NEC: CMR CEC: CMR	4	1000	304.8	30.0	13.6	.241	6.12	8.2	5.0	330	1	2.0	72.3	70.3	64.8	100±15	20.0
				A-1000	A-304.8	33.0	15.0						10	6.0	57.3	51.3	44.8	100±15	25.0
													20	8.5	52.8	44.3	38.8	100±15	25.0
													31.25	10.7	49.9	39.2	34.9	100±15	23.6
													62.5	15.4	45.4	30.0	28.9	100±15	21.5
													100	19.8	42.3	22.5	24.8	100±15	20.1
													200	29.0	37.8	8.8	18.8	100±22	18.0
													250	32.8	36.3	3.5	16.8	100±32	17.3

Jacket sequentially marked at 2 ft. intervals.
Features Descending Length Marking.
Third party verified to TIA/EIA-568-B.2-1, Category 6

Plenum • Dual FRPO/FEP Insulation • Flamarrest® Jacket (Avail. in Red, Orange, Yellow, Green, Blue, Purple, Gray, Natural or Black)

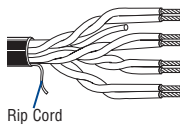
 <p>Rip Cord</p>	7882A	NEC: CMP CEC: CMP	4	1000	304.8	29.0	13.2	.224	5.69	8.2	5.0	330	1	2.0	72.3	70.3	64.8	100±15	20.0
				A-1000	A-304.8	32.0	14.5						10	6.0	57.3	51.3	44.8	100±15	25.0
													20	8.5	52.8	44.3	38.8	100±15	25.0
													31.25	10.7	49.9	39.2	34.9	100±15	23.6
													62.5	15.4	45.4	30.0	28.9	100±15	21.5
													100	19.8	42.3	22.5	24.8	100±15	20.1
													200	29.0	37.8	8.8	18.8	100±22	18.0
													250	32.8	36.3	3.5	16.8	100±32	17.3

Jacket sequentially marked at 2 ft. intervals.
Features Descending Length Marking.
Third party verified to TIA/EIA-568-B.2-1, Category 6

ACR = Attenuation Crosstalk Ratio • BC = Bare Copper • DCR = DC Resistance • ELFEXT = Equal Level Far-end Crosstalk • FEP = Fluorinated Ethylene Propylene • FRPO = Flame-retardant Polyolefin • NEXT = Near-end Crosstalk • PSUM = Power Sum • RL = Return Loss • UTP = Unshielded Twisted Pair(s)

For either T568-A or T568-B configurations.

Color Codes: DataTwist 6

Pair No.	Color Combination
1	White/Blue Stripe & Blue
2	White/Orange Stripe & Orange
3	White/Green Stripe & Green
4	White/Brown Stripe & Brown

DataTwist 6 Limited Combustible UTP Cable

TIA/EIA 568-B.2-1, Category 6

Enhanced Category 6 Bonded-Pair Cables

Description	Part No.	UL NEC/ C(UL) CEC Type	No. of Pairs	Standard Lengths		Standard Unit Wt.		Nominal OD		Max. DCR (Ω/ 100m)	Max. DCR Unbal. (%)	Max. Cap. Unbal. (pF/ 100m)	Freq. (MHz)	Max. Atten. (dB/ 100m)	Min. PSUM NEXT (dB)	Min. PSUM ACR (dB/ 100m)	Min. PSUM ELFEXT (dB/ 100m)	Input Imped. (Ω)	Min. RL (dB)
				Ft.	m	Lbs.	kg	Inch	mm										

23 AWG Bonded-Pairs • Solid Bare Copper Conductors • Twisted Pairs • Central Rod Filler • Rip Cord • See Color Code Chart (below)

Plenum • FEP Teflon® Insulation • FEP Jacket (Available in Light Blue or White)

Part No.	UL NEC/ C(UL) CEC Type	No. of Pairs	Standard Lengths (Ft./m)	Standard Unit Wt. (Lbs./kg)	Nominal OD (Inch/mm)	Max. DCR (Ω/100m)	Max. DCR Unbal. (%)	Max. Cap. Unbal. (pF/100m)	Freq. (MHz)	Max. Atten. (dB/100m)	Min. PSUM NEXT (dB)	Min. PSUM ACR (dB/100m)	Min. PSUM ELFEXT (dB/100m)	Input Imped. (Ω)	Min. RL (dB)							
7813LC	NEC: Limited Combustible FHC 25/50 CMP CEC: CMP	4	1000	304.8	35.0	15.89	.214	5.44	8.2	5.0	330	1	2.0	72.3	70.3	64.8	100±15	20.0				
			U-1000	U-304.8	33.0	14.98																

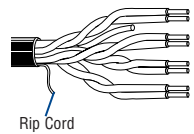

Jacket sequentially marked at 2 ft. intervals.
Features Descending Length Marking.
Third party verified to TIA/EIA 568-B.2-1, Category 6
U.S. Patents 5,606,151 and 5,734,126

ACR = Attenuation Crosstalk Ratio • ELFEXT = Equal Level Far-end Crosstalk • FEP = Fluorinated Ethylene Propylene • NEXT = Near-end Crosstalk • RL = Return Loss • UTP = Unshielded Twisted Pair(s)
Teflon is a DuPont trademark.

Color Codes: DataTwist 6 LC

Pair No.	Color Combination
1	White/Blue Stripe, Blue
2	White/Orange Stripe, Orange
3	White/Green Stripe, Green
4	White/Brown Stripe, Brown



DataTwist® 5e+ UTP Cable

TIA/EIA-568-B.2, Category 5e

Enhanced Category 5e Nonbonded-Pair Cables

Description	Part No.	UL NEC/ C(UL) CEC Type	No. of Pairs	Standard Lengths		Standard Unit Wt.		Nominal OD		Max. DCR (Ω/100m)	Max. DCR Unbal. (%)	Max. Cap. Unbal. (pF/100m)	Freq. (MHz)	Max. Atten. (dB/100m)	Min. PSUM NEXT (dB)	Min. PSUM ACR (dB/100m)	Min. PSUM ELFEXT (dB/100m)	Input Imped. (Ω)	Min. RL (dB)
				Ft.	m	Lbs.	kg	Inch	mm										

24 AWG Solid Bare Copper Conductors • Twisted Pairs • Rip Cord • See Color Code Chart (below)

Non-Plenum • Polyolefin Insulation • PVC Jacket (Available in Red, Orange, Yellow, Green, Blue, Gray or White)

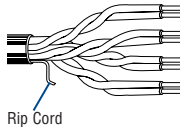
	1500A	NEC:	4	1000	304.8	23.0	10.4	.190	4.83	9.0	3.0	200	1	2.0	65.3	63.3	60.8	100±12	20.0			
		CM		A-1000	A-304.8	26.0	11.8								4	4.0	56.3	52.3	48.7	100±12	23.0	
		CEC:														8	5.7	51.8	46.1	42.7	100±12	24.5
		CM														10	6.4	50.3	43.9	40.8	100±12	25.0
																16	8.1	47.3	39.1	36.7	100±12	25.0
																25	10.3	44.3	34.1	32.8	100±15	24.3
																31.25	11.6	42.9	31.3	30.9	100±15	23.6
																62.5	16.8	38.4	21.6	24.9	100±15	21.5
																100	21.7	35.3	17.1	20.8	100±15	20.1
																155	27.7	32.5	4.7	16.9	100±18	19.0
													200	32.0	30.8	3.0	14.7	100±20	19.0			
													250	36.4	29.3	—	12.8	100±20	18.0			
													350	44.3	27.2	—	9.9	100±22	17.0			
	1500R	NEC:	4	1000	304.8	24.0	10.9	.194	4.93													
		CMR		A-1000	A-304.8	27.0	12.3															
		CEC:																				
		CMR																				

Jacket sequentially marked at 2 ft. intervals
 Features Descending Length Marking.
 Third party verified to TIA/EIA-568-B.2, Category 5e

Plenum • Dual FRPO/FEP Insulation • Flamarrest® Jacket (Avail. in Red, Orange, Yellow, Green, Blue, Gray, White or Natural)

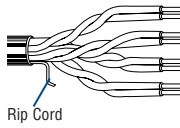
	1501A	NEC:	4	1000†	304.8	23.0	10.4	.190	4.83	9.0	3.0	200	1	2.0	65.3	63.3	60.8	100±12	20.0			
		CMP		A-1000	A-304.8	26.0	11.8								4	4.0	56.3	52.3	48.7	100±12	23.0	
		CEC:														8	5.7	51.8	46.1	42.7	100±12	24.5
		CMP														10	6.4	50.3	43.9	40.8	100±12	25.0
																16	8.1	47.3	39.1	36.7	100±12	25.0
																25	10.3	44.3	34.1	32.8	100±15	24.3
																31.25	11.6	42.9	31.3	30.9	100±15	23.6
																62.5	16.8	38.4	21.6	24.9	100±15	21.5
																100	21.7	35.3	17.1	20.8	100±15	20.1
																155	27.7	32.5	4.7	16.9	100±18	19.0
													200	32.0	30.8	3.0	14.7	100±20	19.0			
													250	36.4	29.3	—	12.8	100±20	18.0			
													350	44.3	27.2	—	9.9	100±22	17.0			

†1000 ft. put-up not available in Red.
 Jacket sequentially marked at 2 ft. intervals
 Features Descending Length Marking.
 Third party verified to TIA/EIA-568-B.2, Category 5e

ACR = Attenuation Crosstalk Ratio • DCR = DC Resistance • ELFEXT = Equal Level Far-end Crosstalk • FEP = Fluorinated Ethylene Propylene • FRPO = Flame-retardant Polyolefin • NEXT = Near-end Crosstalk • PSUM = Power Sum • RL = Return Loss • UTP = Unshielded Twisted Pair(s)

Color Codes: DataTwist 5e+

Pair No.	Color Combination
1	White/Blue Stripe & Blue
2	White/Orange Stripe & Orange
3	White/Green Stripe & Green
4	White/Brown Stripe & Brown

Teflon is a DuPont trademark.

Get the Bonded-Pairs Cable Preparation Tool

See page 15.40 for details.
(Part No. 1797B)



DataTwist 350 Composite UTP Cable

ANSI/TIA/EIA 568-B.2, Category 5e

Banana Peel® Jacketless Cables

Description	Part No.	UL NEC/ C(UL) CEC Type	No. of Pairs	Standard Lengths		Standard Unit Wt.		Nominal OD		Max. DCR (Ω/100m)	Max. DCR Unbal. (%)	Max. Cap. Unbal. (pF/100m)	Freq. (MHz)	Max. Atten. (dB/100m)	Min. PSUM NEXT (dB)	Min. PSUM ACR (dB/100m)	Min. PSUM ELFEXT (dB/100m)	Input Imped. (Ω)	Min. RL (dB)
				Ft.	m	Lbs.	kg	Inch	mm										

24 AWG Bonded-Pairs • Solid Bare Copper Conductors • Spline Filler • Rip Cord • See Color Code Chart (below)

Non-Plenum • Polyolefin Insulation • PVC Inner Jacket (Available in Light Blue or Gray) • **No Overall Jacket**

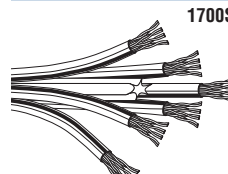
	1700S6	NEC:	24	500	152.4	77.5	35.19	.204	5.18	9.0	3.0	66.0	1	2.0	65.3	63.3	60.8	100±12	20.0	
		CMR:		1000	304.8	149.0	67.65	Bundled:						10	6.4	50.3	43.9	40.8	100±12	25.0
		CEC:						.600		15.24				16	8.1	47.3	39.1	36.7	100±12	25.0
		CMG:												31.25	11.6	42.9	31.3	30.9	100±15	23.6
														62.5	16.8	38.4	21.6	24.9	100±15	21.5
														100	21.7	35.3	17.1	20.8	100±15	20.1
														200	32.0	30.8	3.0	14.7	100±20	19.0
													250	36.4	29.3	>0.0	12.8	100±20	18.0	
													350	44.3	27.2	—	9.9	100±22	17.0	

Bundled version of 1700R.
 U.S. Patents 5,606,151; 5,734,126; 7,049,523.
 Individual leg is third party verified to ANSI/TIA/EIA 568-B.2, Category 5e

Plenum • FEP Insulation • Flamarrest® Inner Jacket (Available in Blue or Natural) • **No Overall Jacket**

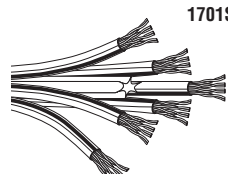
	1701S6	NEC:	24	500	152.4	81.5	37.00	.195	4.95	9.0	3.0	66.0	1	2.0	65.3	63.3	60.8	100±12	20.0	
		CMP:		1000	304.8	157.0	71.28	Bundled:						10	6.4	50.3	43.9	40.8	100±12	25.0
		CEC:						.600		15.24				16	8.1	47.3	39.1	36.7	100±12	25.0
		CMP:												31.25	11.6	42.9	31.3	30.9	100±15	23.6
														62.5	16.8	38.4	21.6	24.9	100±15	21.5
														100	21.7	35.3	17.1	20.8	100±15	20.1
														200	32.0	30.8	3.0	14.7	100±20	19.0
													250	36.4	29.3	>0.0	12.8	100±20	18.0	
													350	44.3	27.2	—	9.9	100±22	17.0	

Bundled version of 1701A.
 U.S. Patents 5,606,151; 5,734,126; 7,049,523.
 Individual leg is third party verified to ANSI/TIA/EIA 568-B.2, Category 5e

UTP = Unshielded Twisted Pair(s) • NEXT = Near-end Crosstalk • ACR = Attenuation Crosstalk Ratio • ELFEXT = Equal Level Far-end Crosstalk • RL = Return Loss

Color Codes: DT 350 Composite

Pair No.	Color Combination
1	White/Blue Stripe & Blue
2	White/Orange Stripe & Orange
3	White/Green Stripe & Green
4	White/Brown Stripe & Brown



DataTwist® 5e UTP Cable

TIA/EIA-568-B.2, Category 5e Nonbonded-Pair Cables

Description	Part No.	UL NEC/ C(UL) CEC Type	No. of Pairs	Standard Lengths		Standard Unit Wt.		Nominal OD		Max. DCR (Ω/ 100m)	Max. DCR Unbal. (%)	Max. Cap. Unbal. (pF/ 100m)	Freq. (MHz)	Max. Atten. (dB/ 100m)	Min. PSUM NEXT (dB)	Min. PSUM ACR (dB/ 100m)	Min. PSUM ELFEXT (dB/ 100m)	Input Imped. (Ω)	Min. RL (dB)
				Ft.	m	Lbs.	kg	Inch	mm										

24 AWG Solid Bare Copper Conductors • Twisted Pairs • Rip Cord • See Color Code Chart (below)

Non-Plenum • Polyolefin Insulation • PVC Jacket (Available in Dark Gray or Blue)

	1588A	NEC:	2	U-1000	U-304.8	14.0	6.4	.183	4.65	9.38	5.0	330	1	2.0	62.3	60.3	60.8	100±15	20.0
		CM		1000	304.8	15.0	6.8												
		CEC:		1640†	500.0	24.6	11.2												
		CM																	
	1588R	NEC:	2	U-1000††	U-304.8	14.0	6.4	.183	4.65	9.38	5.0	330	1	2.0	62.3	60.3	60.8	100±15	20.0
		CMR		1000††	304.8	15.0	6.8												
		CEC:																	
		CMR																	

†1640 ft. put-up available in Dark Gray only.

††U-1000 ft. and 1000 ft. put-ups available in Blue only

Jacket sequentially marked at 2 ft. intervals. Third party verified to TIA/EIA-568-B.2, Category 5e

Non-Plenum • Polyolefin Insulation • PVC Jacket (Available in White, Black, Gray, Blue, Red, Orange, Yellow, Green or Pink)

	1583A	NEC:	4	U-1000	U-304.8	21.0	9.5	.195	4.95	9.38	3.0	330	1	2.0	62.3	60.3	60.8	100±15	20.0
		CM		1000	304.8	21.0	9.5												
		CEC:		1640†	500.0	34.4	15.7												
		CM		3000†	914.4	63.0	28.6												
	1583R	NEC:	4	U-1000††	U-304.8	22.0	10.0	.197	5.00	9.38	3.0	330	1	2.0	62.3	60.3	60.8	100±15	20.0
		CMR		1000††	304.8	22.0	10.0												
		CEC:		3000††	914.4	63.0	28.6												
		CMR																	

†1640 ft. put-up available in Dark Gray or Blue only. 3000 ft. put-up available in Dark Gray, White or Blue only.

††1583R is not available in Black. 3000 ft. put-ups available in Dark Gray, White or Blue only.

Jacket sequentially marked at 2 ft. intervals. Third party verified to TIA/EIA-568-B.2, Category 5e

Non-Plenum • Polyolefin Insulation • Fluorescent Pink PVC Jacket

	DataBrite® 1583B	NEC:	4	U-1000	U-304.8	19.0	8.6	.195	4.95	9.38	3.0	330	1	2.0	62.3	60.3	60.8	100±15	20.0
		CMR		1000	304.8	20.0	9.1												
		CEC:																	
		CMR																	

Jacket sequentially marked at 2 ft. intervals. Third party verified to TIA/EIA-568-B.2, Category 5e

Non-Plenum • Polyolefin Insulation • UV Resistant PVC Jacket (Available in Gray, White or Ivory)

	Indoor/Outdoor 1594A	NEC:	4	U-1000	U-304.8	26.0	11.8	.220	5.58	9.38	3.0	330	1	2.0	62.3	60.3	60.8	100±15	20.0
		CMR/CMX																	
		CEC:																	
		CMR/CMX																	

Jacket sequentially marked at 2 ft. intervals. Third party verified to TIA/EIA-568-B.2, Category 5e

Outside Plant • Polyolefin Insulation • Black Gel-filled Polyethylene Jacket

	Outdoor 7997A		4	1000	304.8	38.0	17.2	.251	6.38	8.90	3.0	66.0	1	2.0	68.3	66.3	64.8	100±15	20.0

Jacket sequentially marked at 2 ft. intervals. Third party verified to TIA/EIA-568-B.2, Category 5e

ACR = Attenuation Crosstalk Ratio • DCR = DC Resistance • ELFEXT = Equal Level Far-end Crosstalk • NEXT = Near-end Crosstalk • PSUM = Power Sum • RL = Return Loss • UTP = Unshielded Twisted Pair(s)

Color Codes: DataTwist 5e

Pair No.	Color Combination
1	White/Blue Stripe & Blue
2	White/Orange Stripe & Orange
3	White/Green Stripe & Green
4	White/Brown Stripe & Brown



DataTwist® 5e UTP Cable

TIA/EIA-568-B.2, Category 5e Nonbonded-Pair Cables

Description	Part No.	UL NEC/ C(UL) CEC Type	No. of Pairs	Standard Lengths		Standard Unit Wt.		Nominal OD		Max. DCR (Ω/100m)	Max. DCR Unbal. (%)	Max. Cap. Unbal. (pF/100m)	Freq. (MHz)	Max. Atten. (dB/100m)	Min. PSUM NEXT (dB)	Min. PSUM ACR (dB/100m)	Min. PSUM ELFEXT (dB/100m)	Input Imped. (Ω)	Min. RL (dB)
				Ft.	m	Lbs.	kg	Inch	mm										

24 AWG Solid Bare Copper Conductors • Twisted Pairs • Rip Cord • See Color Code Chart (below)

Plenum • FEP Teflon® Insulation • Flamarrest® Jacket (Available in Natural or Blue)

Description	Part No.	UL NEC/ C(UL) CEC Type	No. of Pairs	Standard Lengths		Standard Unit Wt.		Nominal OD		Max. DCR (Ω/100m)	Max. DCR Unbal. (%)	Max. Cap. Unbal. (pF/100m)	Freq. (MHz)	Max. Atten. (dB/100m)	Min. PSUM NEXT (dB)	Min. PSUM ACR (dB/100m)	Min. PSUM ELFEXT (dB/100m)	Input Imped. (Ω)	Min. RL (dB)
				Ft.	m	Lbs.	kg	Inch	mm										
 <p>Rip Cord</p>	1590A	NEC: CMP CEC: CMP FT6	2	1000	304.8	16.0	7.3	.175	4.44	9.38	5.0	330	1	2.0	62.3	60.3	60.8	100±15	20.0
				10	6.5	47.3	49.2	40.8	100±15	25.0									
				16	8.2	44.3	40.8	36.7	100±15	25.0									
				31.25	11.7	39.9	36.0	30.9	100±15	23.6									
				62.5	17.0	35.4	28.2	24.8	100±15	21.5									
				100	22.0	32.3	19.0	20.8	100±15	20.1									
200	32.0	27.8	10.3	14.7	100±25	15.0													

Jacket sequentially marked at 2 ft. intervals. Third party verified to TIA/EIA-568-B.2, Category 5e

Plenum • FEP Teflon® Insulation • Flamarrest® Jacket (Red, Orange, Yellow, Green, Gray, White, Black, Pink, Natural or Blue)

Description	Part No.	UL NEC/ C(UL) CEC Type	No. of Pairs	Standard Lengths		Standard Unit Wt.		Nominal OD		Max. DCR (Ω/100m)	Max. DCR Unbal. (%)	Max. Cap. Unbal. (pF/100m)	Freq. (MHz)	Max. Atten. (dB/100m)	Min. PSUM NEXT (dB)	Min. PSUM ACR (dB/100m)	Min. PSUM ELFEXT (dB/100m)	Input Imped. (Ω)	Min. RL (dB)
				Ft.	m	Lbs.	kg	Inch	mm										
 <p>Rip Cord</p>	1585A	NEC: CMP CEC: CMP FT6	4	U-1000	U-304.8	23.0	10.5	.198	5.03	9.38	3.0	330	1	2.0	62.3	60.3	60.8	100±15	20.0
				1000	304.8	24.0	10.9	4	4.1	53.3	49.2	48.7	100±15	23.0					
				3000†	914.6	69.0	31.4	10	6.5	47.3	40.8	40.8	100±15	25.0					
				16	8.2	44.3	36.0	36.7	100±15	25.0									
				31.25	11.7	39.9	28.2	30.9	100±15	23.6									
				62.5	17.0	35.4	19.0	24.8	100±15	21.5									
100	22.0	32.3	10.3	20.8	100±15	20.1													
200	32.0	27.8	1.0	14.7	100±25	15.0													

†3000 ft. put-up available in Natural or Blue only. Jacket sequentially marked at 2 ft. intervals. Third party verified to TIA/EIA-568-B.2, Category 5e

Plenum • FEP Teflon Insulation • Fluorescent Pink Flamarrest Jacket

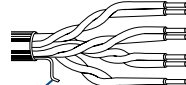
Description	Part No.	UL NEC/ C(UL) CEC Type	No. of Pairs	Standard Lengths		Standard Unit Wt.		Nominal OD		Max. DCR (Ω/100m)	Max. DCR Unbal. (%)	Max. Cap. Unbal. (pF/100m)	Freq. (MHz)	Max. Atten. (dB/100m)	Min. PSUM NEXT (dB)	Min. PSUM ACR (dB/100m)	Min. PSUM ELFEXT (dB/100m)	Input Imped. (Ω)	Min. RL (dB)
				Ft.	m	Lbs.	kg	Inch	mm										
 <p>Rip Cord</p>	DataBrite® 1585B	NEC: CMP CEC: CMP FT6	4	1000	304.8	24.0	10.9	.197	5.00	9.38	3.0	330	1	2.0	62.3	60.3	60.8	100±15	20.0
				10	6.5	47.3	40.8	40.8	100±15	25.0									
				16	8.2	44.3	36.0	36.7	100±15	25.0									
				31.25	11.7	39.9	28.2	30.9	100±15	23.6									
				62.5	17.0	35.4	19.0	24.8	100±15	21.5									
				100	22.0	32.3	10.3	20.8	100±15	20.1									
200	32.0	27.8	1.0	14.7	100±25	15.0													

Jacket sequentially marked at 2 ft. intervals. Third party verified to TIA/EIA-568-B.2, Category 5e

Plenum • FEP Teflon Insulation • FEP Jacket (Available in Blue or White)

Description	Part No.	UL NEC/ C(UL) CEC Type	No. of Pairs	Standard Lengths		Standard Unit Wt.		Nominal OD		Max. DCR (Ω/100m)	Max. DCR Unbal. (%)	Max. Cap. Unbal. (pF/100m)	Freq. (MHz)	Max. Atten. (dB/100m)	Min. PSUM NEXT (dB)	Min. PSUM ACR (dB/100m)	Min. PSUM ELFEXT (dB/100m)	Input Imped. (Ω)	Min. RL (dB)
				Ft.	m	Lbs.	kg	Inch	mm										
 <p>Rip Cord</p>	1585LC	NEC: Limited Combustible FHC 25/50 CEC: CMP FT6	4	U-1000	U-304.8	23.0	10.5	.195	4.95	9.38	3.0	330	1	2.0	62.3	60.3	60.8	100±15	20.0
				1000	304.8	23.0	10.5	4	4.1	53.3	49.2	48.7	100±15	23.0					
				10	6.5	47.3	40.8	40.8	100±15	25.0									
				16	8.2	44.3	36.0	36.7	100±15	25.0									
				31.25	11.7	39.9	28.2	30.9	100±15	23.6									
				62.5	17.0	35.4	19.0	24.8	100±15	21.5									
100	22.0	32.3	10.3	20.8	100±15	20.1													
200	32.0	27.8	1.0	14.7	100±25	15.0													

Jacket sequentially marked at 2 ft. intervals. No rip cord. Third party verified to TIA/EIA-568-B.2, Category 5e

Patch Cable • 24 AWG Stranded (7x32) Bare Copper Conductors • Twisted Pairs • RJ-45 Compatible* • See Color Code Chart (below)

Non-Plenum • Polyolefin Insulation • PVC Jacket (Available in Red, Orange, Yellow, Green, Blue, Purple, Light Gray, White or Black)

Description	Part No.	UL NEC/ C(UL) CEC Type	No. of Pairs	Standard Lengths		Standard Unit Wt.		Nominal OD		Max. DCR (Ω/100m)	Max. DCR Unbal. (%)	Max. Cap. Unbal. (pF/100m)	Freq. (MHz)	Max. Atten. (dB/100m)	Min. PSUM NEXT (dB)	Min. PSUM ACR (dB/100m)	Min. PSUM ELFEXT (dB/100m)	Input Imped. (Ω)	Min. RL (dB)
				Ft.	m	Lbs.	kg	Inch	mm										
 <p>Rip Cord</p>	Patch Cable 1592A	NEC: CM CEC: CM FT1	4	U-1000	U-304.8	22.0	10.0	.213	5.41	9.38	3.0	330	1	2.5	62.3	—	60.8	100±15	20.0
				1000	304.8	23.0	10.5	4	4.9	53.3	—	48.7	100±15	23.0					
				10	7.8	47.3	—	40.8	100±15	25.0									
				16	9.9	44.3	—	36.7	100±15	25.0									
				31.25	14.1	39.9	—	30.9	100±15	23.6									
				62.5	20.4	35.4	—	24.8	100±15	21.5									
100	26.4	32.3	—	20.8	100±15	20.1													
200	38.9	27.8	—	14.7	100±25	15.0													

*RJ-45 compatible for either T568-A or T568-B configurations. Jacket sequentially marked at 2 ft. intervals. Third party verified to TIA/EIA-568-B.2, Category 5e Patch

ACR = Attenuation Crosstalk Ratio • DCR = DC Resistance • ELFEXT = Equal Level Far-end Crosstalk • FEP = Fluorinated Ethylene Propylene • NEXT = Near-end Crosstalk • PSUM = Power Sum • RL = Return Loss • UTP = Unshielded Twisted Pair(s)

Color Codes: DataTwist 5e

Pair No.	Color Combination
1	White/Blue Stripe & Blue
2	White/Orange Stripe & Orange
3	White/Green Stripe & Green
4	White/Brown Stripe & Brown

Teflon is a DuPont trademark.



For more information, contact Belden Technical Support: 1-800-BELDEN-1 • www.belden.com

IBDN Plus 25-Pair Cat5E UTP Cable

TIA/EIA-568-B.2, Category 5E

Enhanced Category 5 Nonbonded-pair Cables

Description	Part No.	UL NEC/ C(UL) CEC Type	No. of Pairs	Standard Lengths		Standard Unit Wt.		Nominal OD		Max. DCR (Ω/100m)	Max. DCR Unbal. (%)	Max. Cap. Unbal. (pF/100m)	Freq. (MHz)	Max. Atten. (dB/100m)	Min. PSUM NEXT (dB)	Min. PSUM ELFEXT (dB/100m)	Input Imped. (Ω)	Min. RL (dB)
				Ft.	m	Lbs.	kg	Inch	mm									

24 AWG Solid Bare Copper Conductors • Twisted Pairs • Rip Cord • See Color Code Chart (below)

Non-Plenum • Polyolefin Insulation • Gray PVC Jacket

Gray, Reel	24576125	NEC: 25 CMR CEC: CMR	25	1000	304.8	119	54.0	.490	12.45	9.38	—	330	0.772	1.8	64.0	63.0	102±15	19.4
													1.0	2.0	62.3	63.8	100±15	20.0
													4.0	4.1	53.3	48.8	100±15	23.0
													8.0	15.8	48.8	42.7	100±15	24.5
													10.0	16.5	47.3	40.8	100±15	25.0
													16.0	8.2	44.2	36.7	100±15	25.0
													20.0	9.3	42.8	34.8	100±15	25.0
													25.0	10.4	41.3	32.8	100±15	24.3
													31.25	11.7	39.9	30.9	100±15	23.6
													62.5	17.0	35.4	24.9	100±15	21.5
													100.0	22.0	32.3	20.8	100±15	20.1

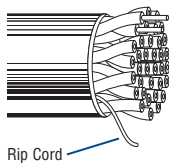

Jacket sequentially market at 2 ft. intervals.
Third party verified to TIA/EIA-568-B.2, Category 5e

Plenum • FEP Insulation • Gray Low-smoke PVC Jacket

Gray, Reel	24577125	NEC: 25 CMP CEC: CMP	25	1000	304.8	127	57.6	.430	10.90	9.38	—	330	0.772	1.8	64.0	63.0	102±15	19.4
													1.0	2.0	62.3	63.8	100±15	20.0
													4.0	4.1	53.3	48.8	100±15	23.0
													8.0	15.8	48.8	42.7	100±15	24.5
													10.0	16.5	47.3	40.8	100±15	25.0
													16.0	8.2	44.2	36.7	100±15	25.0
													20.0	9.3	42.8	34.8	100±15	25.0
													25.0	10.4	41.3	32.8	100±15	24.3
													31.25	11.7	39.9	30.9	100±15	23.6
													62.5	17.0	35.4	24.9	100±15	21.5
													100.0	22.0	32.3	20.8	100±15	20.1

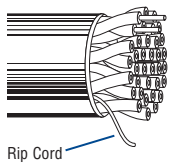

Jacket sequentially market at 2 ft. intervals.
Third party verified to TIA/EIA-568-B.2, Category 5e

ACR = Attenuation Crosstalk Ratio • DCR = DC Resistance • ELFEXT = Equal Level Far-end Crosstalk • NEXT = Near-end Crosstalk • PSUM = Power Sum • RL = Return Loss • UTP = Unshielded Twisted Pair(s)

**Color Codes:
IBDN Plus 25-Pair Cat5**

Pair No.	Tip	Ring
1	White	Blue
2	White	Orange
3	White	Green
4	White	Brown
5	White	Slate
6	Red	Blue
7	Red	Orange
8	Red	Green
9	Red	Brown
10	Red	Slate
11	Black	Blue
12	Black	Orange
13	Black	Green
14	Black	Brown
15	Black	Slate
16	Yellow	Blue
17	Yellow	Orange
18	Yellow	Green
19	Yellow	Brown
20	Yellow	Slate
21	Violet	Blue
22	Violet	Orange
23	Violet	Green
24	Violet	Brown
25	Violet	Slate



IBDN Plus 25-Pair Cat5 UTP Cable

TIA/EIA-568-A, Category 5

Category 5 Nonbonded-pair Cables

Description	Part No.	UL NEC/ C(UL) CEC Type	No. of Pairs	Standard Lengths		Standard Unit Wt.		Nominal OD		Max. DCR (Ω/100m)	Max. DCR Unbal. (%)	Max. Cap. Unbal. (pF/100m)	Freq. (MHz)	Max. Atten. (dB/100m)	Min. PSUM NEXT (dB)	Input Imped. (Ω)	Min. SRL (dB)
				Ft.	m	Lbs.	kg	Inch	mm								

24 AWG Solid Bare Copper Conductors • Twisted Pairs • Rip Cord • See Color Code Chart (below)

Non-Plenum • Polyolefin Insulation • Blue PVC Jacket

Blue, Reel	24572238	NEC:	25	1000	304.8	118.0	53.5	4.90	124.5	9.38	5.0	330	0.772	1.8	64.0	102±15	—
Blue, Reel	24572250	CMR	25	492	150.0								1.0	2.1	62.0	100±15	23
Blue,, Reel	24572260	CEC:	25	500	152.4								4.0	4.3	53.0	100±15	23
		CMR											8.0	5.9	48.0	100±15	23
													10.0	6.6	47.0	100±15	23
													16.0	8.2	44.0	100±15	23
													20.0	9.2	42.0	100±15	23
													25.0	10.5	41.0	100±15	22
													31.25	11.8	40.0	100±15	21
													62.5	17.1	35.0	100±15	18
													100.0	22.0	32.0	100±15	16

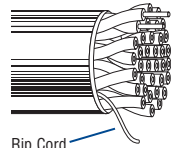

Rip Cord

Jacket sequentially market at 2 ft. intervals.
Third party verified to TIA/EIA-568-A, Category 5

Plenum • 100% FEP Insulation • Gray Low-Smoke PVC Jacket

Gray, Reel	24572351	NEC:	25	328	100.0	118.0	53.5	4.90	124.5	9.38	5.0	330	0.772	1.8	64.0	102±15	—
Gray, Reel	24572352	CMP	25	984	300.0								1.0	2.1	62.0	100±15	23
Gray, Reel	24572353	CEC:	25	1000	304.8								4.0	4.3	53.0	100±15	23
		CMP											8.0	5.9	48.0	100±15	23
													10.0	6.6	47.0	100±15	23
													16.0	8.2	44.0	100±15	23
													20.0	9.2	42.0	100±15	23
													25.0	10.5	41.0	100±15	22
													31.25	11.8	40.0	100±15	21
													62.5	17.1	35.0	100±15	18
													100.0	22.0	32.0	100±15	16

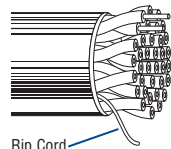

Rip Cord

Jacket sequentially market at 2 ft. intervals.
Third party verified to TIA/EIA-568-A, Category 5

ACR = Attenuation Crosstalk Ratio • DCR = DC Resistance • ELFEXT = Equal Level Far-end Crosstalk • NEXT = Near-end Crosstalk • PSUM = Power Sum • RL = Return Loss • UTP = Unshielded Twisted Pair(s)

**Color Codes:
IBDN Plus 25-Pair Cat5**

Pair No.	Tip	Ring
1	White	Blue
2	White	Orange
3	White	Green
4	White	Brown
5	White	Slate
6	Red	Blue
7	Red	Orange
8	Red	Green
9	Red	Brown
10	Red	Slate
11	Black	Blue
12	Black	Orange
13	Black	Green
14	Black	Brown
15	Black	Slate
16	Yellow	Blue
17	Yellow	Orange
18	Yellow	Green
19	Yellow	Brown
20	Yellow	Slate
21	Violet	Blue
22	Violet	Orange
23	Violet	Green
24	Violet	Brown
25	Violet	Slate



Data Grade Armored Riser 25-Pair UTP Cable

TIA/EIA-568-A, Category 5

Category 5 Nonbonded-pair Cables

Description	Part No.	UL NEC/ C(UL) CEC Type	No. of Pairs	Standard Lengths		Standard Unit Wt.		Nominal OD		Max. DCR (Ω/100m)	Max. DCR Unbal. (%)	Max. Cap. Unbal. (pF/100m)	Freq. (MHz)	Max. Atten. (dB/100m)	Min. PSUM NEXT (dB)	Input Imped. (Ω)	Min. SRL (dB)
				Ft.	m	Lbs.	kg	Inch	mm								

24 AWG Solid Bare Copper Conductors • Twisted Pairs • Rip Cord • See Color Code Chart (below)

Non-Plenum • Flame Retardant Polymer Insulation • ALVYAN Sheath • PVC Jacket

Gray, Reel	25500027	NEC:	25	8200	2500	205.0	93.0	0.62	15.70	9.38	—	328	0.772	1.8	64.0	102±15	—
Gray, Reel	25500028	CMR	25	Cut Length													
		CEC:															
		CMR															
													1.0	2.1	62.3	100±15	23
													4.0	4.3	53.3	100±15	23
													8.0	5.9	48.8	100±15	23
													10.0	6.6	47.3	100±15	23
													16.0	8.2	44.3	100±15	23
													20.0	9.2	42.8	100±15	23
													25.0	10.5	41.3	100±15	22
													31.25	11.8	40.9	100±15	21
													62.5	17.1	35.4	100±15	18
													100.0	22.0	32.3	100±15	16

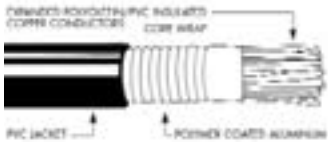

Jacket sequentially marked at 2 ft. intervals.
 Featuring Descending Length Marking.
 Third party verified to TIA/EIA-568-A, Category 5

ACR = Attenuation Crosstalk Ratio • DCR = DC Resistance • ELFEXT = Equal Level Far-end Crosstalk • NEXT = Near-end Crosstalk • PSUM = Power Sum • RL = Return Loss • UTP = Unshielded Twisted Pair(s)

Color Codes: Data Grade Riser

Pair No.	Tip	Ring
1	White	Blue
2	White	Orange
3	White	Green
4	White	Brown
5	White	Slate
6	Red	Blue
7	Red	Orange
8	Red	Green
9	Red	Brown
10	Red	Slate
11	Black	Blue
12	Black	Orange
13	Black	Green
14	Black	Brown
15	Black	Slate
16	Yellow	Blue
17	Yellow	Orange
18	Yellow	Green
19	Yellow	Brown
20	Yellow	Slate
21	Violet	Blue
22	Violet	Orange
23	Violet	Green
24	Violet	Brown
25	Violet	Slate

DataTwist® 5 UTP Cable

TIA/EIA-568-A, Category 5 Nonbonded-Pair Cables

Description	Part No.	UL NEC/ C(UL) CEC Type	No. of Pairs	Standard Lengths		Standard Unit Wt.		Nominal OD		Max. DCR (Ω/100m)	Max. DCR Unbal. (%)	Max. Cap. Unbal. (pF/100m)	Freq. (MHz)	Max. Atten. (dB/100m)	Min. PSUM NEXT (dB)	Fitted Input Imped. (Ω)	Min. SRL (dB)
				Ft.	m	Lbs.	kg	Inch	mm								

24 AWG Solid Bare Copper Conductors • Twisted Pairs • Rip Cord • See Color Code Chart (below)

Non-Plenum • Polyolefin Insulation • PVC Jacket (Available in Light Gray or Blue)

Part No.	UL NEC/ C(UL) CEC Type	No. of Pairs	Standard Lengths (Ft./m)	Standard Unit Wt. (Lbs./kg)	Nominal OD (Inch/mm)	Max. DCR (Ω/100m)	Max. DCR Unbal. (%)	Max. Cap. Unbal. (pF/100m)	Freq. (MHz)	Max. Atten. (dB/100m)	Min. PSUM NEXT (dB)	Fitted Input Imped. (Ω)	Min. SRL (dB)
1864A	NEC: CMR CEC: CMR FT4	25	1000 / 304.8	144.0 / 65.4	.526 / 13.36	9.38	5.0	330	1	2.0	62.3	100±15	23.0
									10	6.5	47.3	100±15	23.0
									16	8.2	44.3	100±15	23.0
									31.25	11.7	39.9	100±15	21.1
									62.5	17.0	35.4	100±15	18.0
									100	22.0	32.3	100±15	16.0

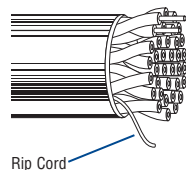

Rip Cord

Jacket sequentially marked at 2 ft. intervals.
Third party verified to TIA/EIA-568-A, Category 5

Plenum • FEP Teflon® Insulation • FEP Jacket (Available in Blue Tint or White Tint)

Part No.	UL NEC/ C(UL) CEC Type	No. of Pairs	Standard Lengths (Ft./m)	Standard Unit Wt. (Lbs./kg)	Nominal OD (Inch/mm)	Max. DCR (Ω/100m)	Max. DCR Unbal. (%)	Max. Cap. Unbal. (pF/100m)	Freq. (MHz)	Max. Atten. (dB/100m)	Min. PSUM NEXT (dB)	Fitted Input Imped. (Ω)	Min. SRL (dB)
1871A	NEC: CMP CEC: CMP	25	1000 / 304.8	131.0 / 59.5	.430 / 10.92	9.38	5.0	330	1	2.0	62.3	100±15	23.0
									10	6.5	47.3	100±15	23.0
									16	8.2	44.3	100±15	23.0
									31.25	11.7	39.9	100±15	21.1
									62.5	17.0	35.4	100±15	18.0
									100	22.0	32.3	100±15	16.0

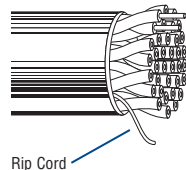

Rip Cord

Jacket sequentially marked at 2 ft. intervals.
Third party verified to TIA/EIA-568-A, Category 5

DCR = DC Resistance • NEXT = Near-end Crosstalk • PSUM = Power Sum • SRL = Structural Return Loss • UTP = Unshielded Twisted Pair(s)

Color Codes: 1864A

Pair	Color Combination
1	White & Blue
2	White & Orange
3	White & Green
4	White & Brown
5	White & Gray
6	Red & Blue
7	Red & Orange
8	Red & Green
9	Red & Brown
10	Red & Gray
11	Black & Blue
12	Black & Orange
13	Black & Green

Pair	Color Combination
14	Black & Brown
15	Black & Gray
16	Yellow & Blue
17	Yellow & Orange
18	Yellow & Green
19	Yellow & Brown
20	Yellow & Gray
21	Purple & Blue
22	Purple & Orange
23	Purple & Green
24	Purple & Brown
25	Purple & Gray

Color Codes: 1871A

Pair	Color Combination
1	White/Blue Stripe & Blue
2	White/Orange Stripe & Orange
3	White/Green Stripe & Green
4	White/Brown Stripe & Brown
5	White/Gray Stripe & Gray
6	Red/Blue Stripe & Blue
7	Red/Orange Stripe & Orange
8	Red/Green Stripe & Green
9	Red/Brown Stripe & Brown
10	Red/Gray Stripe & Gray
11	Black/Blue Stripe & Blue
12	Black/Orange Stripe & Orange
13	Black/Green Stripe & Green

Pair	Color Combination
14	Black/Brown Stripe & Brown
15	Black/Gray Stripe & Gray
16	Yellow/Blue Stripe & Blue
17	Yellow/Orange Stripe & Orange
18	Yellow/Green Stripe & Green
19	Yellow/Brown Stripe & Brown
20	Yellow/Gray Stripe & Gray
21	Purple/Blue Stripe & Blue
22	Purple/Orange Stripe & Orange
23	Purple/Green Stripe & Green
24	Purple/Brown Stripe & Brown
25	Purple/Gray Stripe & Gray

Teflon is a DuPont trademark.



For more information, contact Belden Technical Support: 1-800-BELDEN-1 • www.belden.com

IBDN Plus UTP Cable

TIA/EIA-568-A, Category 5

Category 5 Nonbonded-pair Cables

Description	Part No.	UL NEC/ C(UL) CEC Type	No. of Pairs	Standard Lengths		Standard Unit Wt.		Nominal OD		Max. DCR (Ω/100m)	Max. DCR Unbal. (%)	Max. Cap. Unbal. (pF/100m)	Freq. (MHz)	Max. Atten. (dB/100m)	Min. PSUM NEXT (dB)	Min. PSUM ACR (dB/100m)	Input Imped. (Ω)	Min. SRL (dB)
				Ft.	m	Lbs.	kg	Inch	mm									

24 AWG Solid Bare Copper Conductors • Twisted Pairs • Rip Cord • See Color Code Chart (below)

Non-Plenum • Polyolefin Insulation • PVC Jacket

White, Box	24570086	NEC:	4	1000	304.8	10.9	24.0	.186	4.72	9.38	5.0	330	0.772	1.8	64.0	62.2	—	—
Blue, Box	24570036	CMR											1.0	2.0	62.3	60.3	100±15	23.0
		CEC:											4.0	4.1	53.3	49.2	100±15	23.0
		CMR											8.0	5.8	48.8	43.0	100±15	23.0
													10.0	6.5	47.3	40.8	100±15	23.0
													16.0	8.2	44.3	36.0	100±15	23.0
													20.0	9.3	42.8	33.5	100±15	23.0
													25.0	10.4	41.3	30.9	100±15	22.0
													31.25	11.7	39.9	28.2	100±15	21.1
													62.5	17.0	35.4	18.4	100±15	18.1
													100.0	22.0	32.3	10.3	100±15	16.0
													155.0 [▶]	28.1	29.5	1.4	100±15	14.1

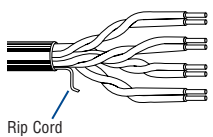

Jacket sequentially marked at 2 ft. intervals.
Featuring Descending Length Marking.
Third party verified to TIA/EIA-568-A, Category 5

Non-Plenum • Polyolefin Insulation • LSZH Polymer Alloy

Purple, Box	24570152	NEC:	4	1000	304.8	11.3	25.0	.198	5.03	9.38	5.0	330	0.772	1.8	64.0	62.2	—	—
		CMR											1.0	2.0	62.3	60.3	100±15	23.0
		CEC:											4.0	4.1	53.3	49.2	100±15	23.0
		CMR											8.0	5.8	48.8	43.0	100±15	23.0
													10.0	6.5	47.3	40.8	100±15	23.0
													16.0	8.2	44.3	36.0	100±15	23.0
													20.0	9.3	42.8	33.5	100±15	23.0
													25.0	10.4	41.3	30.9	100±15	22.0
													31.25	11.7	39.9	28.2	100±15	21.1
													62.5	17.0	35.4	18.4	100±15	18.1
													100.0	22.0	32.3	10.3	100±15	16.0
													155.0 [▶]	28.1	29.5	1.4	100±15	14.1

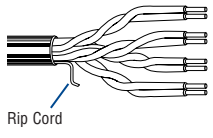

Jacket sequentially marked at 2 ft. intervals.
Featuring Descending Length Marking.
Third party verified to TIA/EIA-568-A, Category 5

Plenum • Dual Insulation: Polyolefin/FEP • Low-Smoke PVC Jacket

White, Box	24570700	NEC:	4	1000	304.8	9.98	22.0	.188	4.78	9.38	5.0	330	0.772	1.8	64.0	62.2	—	—
Blue, Box	24570750	CMP											1.0	2.0	62.3	60.3	100±15	23.0
		CEC:											4.0	4.1	53.3	49.2	100±15	23.0
		CMP											8.0	5.8	48.8	43.0	100±15	23.0
													10.0	6.5	47.3	40.8	100±15	23.0
													16.0	8.2	44.3	36.0	100±15	23.0
													20.0	9.3	42.8	33.5	100±15	23.0
													25.0	10.4	41.3	30.9	100±15	22.0
													31.25	11.7	39.9	28.2	100±15	21.1
													62.5	17.0	35.4	18.4	100±15	18.1
													100.0	22.0	32.3	10.3	100±15	16.0
													155.0 [▶]	28.1	29.5	1.4	100±15	14.1

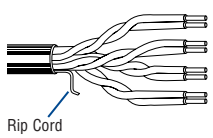

Jacket sequentially marked at 2 ft. intervals.
Featuring Descending Length Marking.
Third party verified to TIA/EIA-568-A, Category 5

ACR = Attenuation Crosstalk Ratio • DCR = DC Resistance • ELFEXT = Equal Level Far-end Crosstalk • NEXT = Near-end Crosstalk • PSUM = Power Sum • RL = Return Loss • UTP = Unshielded Twisted Pair(s)

[▶]Values provided for information only.

Color Codes: IBDN Plus

Pair No.	Color Combination
1	White/Blue Stripe & Blue
2	White/Orange Stripe & Orange
3	White/Green Stripe & Green
4	White/Brown Stripe & Brown



DataTwist® 3 UTP Cable

TIA/EIA-568-A, Category 3 Nonbonded-Pair Cables

Description	Part No.	UL NEC/ C(UL) CEC Type	No. of Pairs	Standard Lengths		Standard Unit Weight		Nominal OD		Nominal DCR (Cond.)	Nom. Imped. (Ω)	Nominal Capacitance		Freq. (MHz)	Min. NEXT (dB)	Maximum Attenuation	
				Ft.	m	Lbs.	kg	Inch	mm			* pF/Ft.	* pF/m			(dB/1000')	(dB/100m)

24 AWG Solid Bare Copper Conductors • Twisted Pairs • See Color Code Chart (below)

Non-Plenum • Polyolefin Insulation • Gray PVC Jacket

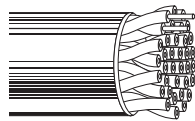

1227A1	NEC:	2	U-1000	U-304.8	13.0	6.0	.173	4.39	28.0Ω/M'	100	19.0	62.3	1	41.0	7.8	2.56
	CMR												4	32.0	17.0	5.58
	CEC:												10	26.0	30.0	9.71
	CMR												16	23.0	40.0	13.10
1229A1	NEC:	4	U-1000	U-304.8	22.0	10.0	.197	5.00								
	CMR															
	CEC:															
CMR																
1232A1	NEC:	25†	1000	304.8	104.0	47.2	.399	10.14								
	CMR															
	CEC:															
CMR																

Jacket sequentially marked at 2 ft. intervals.
Third party verified to TIA/EIA-568-A, Category 3

Plenum • Low-Smoke PVC Insulation • White Low-Smoke PVC Jacket

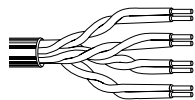

1243A2	NEC:	2	U-1000	U-304.8	14.0	6.4	.170	4.32	28.0Ω/M'	100	19.0	62.3	1	41.0	7.8	2.56
	CMP												4	32.0	17.0	5.58
	CEC:												10	26.0	30.0	9.71
	CMP												16	23.0	40.0	13.10
1245A2	NEC:	4	U-1000	U-304.8	23.0	10.4	.200	5.08								
	CMP															
	CEC:															
CMP																

Jacket sequentially marked at 2 ft. intervals.
Third party verified to TIA/EIA-568-A, Category 3

DCR = DC Resistance • NEXT = Near-end Crosstalk • UTP = Unshielded Twisted Pair(s)

*Capacitance between conductors
† 25-pair NEXT is Power Sum tested.

Not RoHS compliant at time of printing. Please check with Belden Technical Support for current compliance information at 1-800-BELDEN-1.

Color Codes: DataTwist 3

Pair No.	Color Combination	Pair No.	Color Combination
1	White/Blue Stripe & Blue/White Stripe	14	Black/Brown Stripe & Brown/Black Stripe
2	White/Orange Stripe & Orange/White Stripe	15	Black/Gray Stripe & Gray/Black Stripe
3	White/Green Stripe & Green/White Stripe	16	Yellow/Blue Stripe & Blue/Yellow Stripe
4	White/Brown Stripe & Brown/White Stripe	17	Yellow/Orange Stripe & Orange/Yellow Stripe
5	White/Gray Stripe & Gray/White Stripe	18	Yellow/Green Stripe & Green/Yellow Stripe
6	Red/Blue Stripe & Blue/Red Stripe	19	Yellow/Brown Stripe & Brown/Yellow Stripe
7	Red/Orange Stripe & Orange/Red Stripe	20	Yellow/Gray Stripe & Gray/Yellow Stripe
8	Red/Green Stripe & Green/Red Stripe	21	Purple/Blue Stripe & Blue/Purple Stripe
9	Red/Brown Stripe & Brown/Red Stripe	22	Purple/Orange Stripe & Orange/Purple Stripe
10	Red/Gray Stripe & Gray/Red Stripe	23	Purple/Green Stripe & Green/Purple Stripe
11	Black/Blue Stripe & Blue/Black Stripe	24	Purple/Brown Stripe & Brown/Purple Stripe
12	Black/Orange Stripe & Orange/Black Stripe	25	Purple/Gray Stripe & Gray/Purple Stripe
13	Black/Green Stripe & Green/Black Stripe		

D-Inside and D-Flex Plenum UTP Cable

TIA/EIA-568-A and CSA T529-95, Category 3

Category 3 Nonbonded-pair Cables

Description	Part No.	UL NEC/ C(UL) CEC Type	No. of Pairs	Standard Lengths		Standard Unit Wt.		Nominal OD		Max. DCR (Ω/100m)	Max. DCR Unbal. (%)	Max. Cap. Unbal. (pF/100m)	Freq. (MHz)	Max. Atten. (dB/100m)	Min. NEXT (dB)	Input Imped. (Ω)	Min. SRL (dB)
				Ft.	m	Lbs.	kg	Inch	mm								

24 AWG Solid Bare Copper Conductors • Twisted Pairs • Rip Cord • See Color Code Chart (below)

Non-Plenum • Polyvinyl Chloride Insulation • Olive Gray Low-Smoke PVC Jacket

Olive Gray, Box	24501922	NEC:	2	2500	762.0	11.0	4.99	0.13	3.30	9.38	5.0	262	0.772	2.2	43.0	—	—
Olive Gray, Box	24501934	CMR	3	1500	457.2	15.0	6.80	0.15	3.90				1.0	2.6	41.0	100±15	12.0
Olive Gray, Box	24501941	CEC:	4	1000	304.8	18.0	8.16	0.17	4.30				4.0	5.6	32.0	100±15	12.0
Olive Gray, Box	24501950	CMR	4	1500	457.2	18.0	8.16	0.17	4.30				8.0	8.5	28.0	100±15	12.0
Olive Gray, Reel	24501947		4	1000	304.8	18.0	8.16	0.17	4.30				10.0	9.7	26.0	100±15	12.0
													16.0	13.1	23.0	100±15	10.0

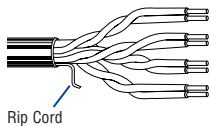

Jacket sequentially marked at 2 ft. intervals.
Featuring Descending Length Marking.
Third party verified to TIA/EIA-568-A, Category 3

Plenum • Low Smoke Polyvinyl Chloride Insulation • Olive Gray Low-Smoke Jacket

Olive Gray, Box	24571097	NEC:	3	1500	457.2	16.0	7.26	0.16	4.06	9.38	5.0	262	0.772	2.2	43.0	—	—
Olive Gray, Box	24571111	CMP	4	1000	304.8	19.0	8.62	0.19	4.70				1.0	2.6	41.0	100±15	12.0
Olive Gray, Box	24571112	CEC:	4	1500	457.2	19.0	8.62	0.19	4.70				4.0	5.6	32.0	100±15	12.0
Olive Gray, Reel	24571110	CMP	4	1000	304.8	19.0	8.62	0.19	4.70				8.0	8.5	28.0	100±15	12.0
													10.0	9.7	26.0	100±15	12.0
													16.0	13.1	23.0	100±15	10.0

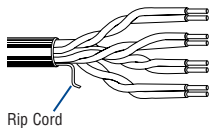

Jacket sequentially marked at 2 ft. intervals.
Featuring Descending Length Marking.
Third party verified to TIA/EIA-568-A, Category 3

ACR = Attenuation Crosstalk Ratio • DCR = DC Resistance • ELFEXT = Equal Level Far-end Crosstalk • NEXT = Near-end Crosstalk • RL = Return Loss • UTP = Unshielded Twisted Pair(s)

Color Codes: D-Inside and D-Flex

Pair No.	Color Combination
1	White/Blue Stripe & Blue/White Stripe
2	White/Orange Stripe & Orange/White Stripe
3	White/Green Stripe & Green/White Stripe
4	White/Brown Stripe & Brown/White Stripe



D-Series Multipair UTP Cable

TIA/EIA-568-A and CSA T529-95, Category 3

Category 3 Nonbonded-pair Cables

Description	Part No.	UL NEC/ C(UL) CEC Type	No. of Pairs	Standard Lengths		Standard Unit Wt.		Nominal OD		Max. DCR (Ω/100m)	Max. DCR Unbal. (%)	Max. Cap. Unbal. (pF/100m)	Freq. (MHz)	Max. Atten. (dB/100m)	Min. PSUM NEXT (dB)	Input Imped. (Ω)	Min. SRL (dB)
				Ft.	m	Lbs.	kg	Inch	mm								

24 AWG Solid Bare Copper Conductors • Twisted Pairs • Rip Cord • See Color Code Chart (below)

Non-Plenum • Semi-Rigid Polyvinyl Chloride Insulation • Olive Gray PVC Jacket																	
Olive Gray, Reel	24501829	NEC:	6	1000	304.8	28.0	12.7	0.21	5.3	—	8.8	262	0.772	2.2	43.0	100±15	12.0
Olive Gray, Reel	24501837	CMR	12	1000	304.8	50.0	22.7	0.28	7.1				1.0	2.6	41.0	100±15	12.0
Olive Gray, Reel	24501848	CEC:	16	984	300.0	64.0	29.0	0.32	8.0				4.0	5.6	32.0	100±15	12.0
Olive Gray, Reel	24501858	CMR	25	1000	304.8	100.0	45.4	0.39	10.0				8.0	8.5	28.0	100±15	12.0
Olive Gray, Reel	24501877		50	1000	304.8	194.0	87.0	0.53	13.4				10.0	9.7	26.0	100±15	12.0
Olive Gray, Reel	24501887		75	2083	635.0	279.0	126.6	0.63	16.0				16.0	13.1	23.0	100±15	10.0
Olive Gray, Reel	24501897		100	1575	480.0	365.0	165.6	0.72	18.2								
Olive Gray, Reel	24501906		200	900	274.3	703.0	318.9	0.99	25.1								

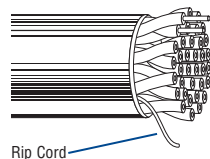

Rip Cord

Jacket sequentially marked at 2 ft. intervals. Featuring Descending Length Marking. Third party verified to TIA/EIA-568-A, Category 3

Plenum • Low Smoke Polyvinyl Chloride Insulation • Low-Smoke PVC Jacket (Gray or Translucent)																	
Translucent, Reel	24571221	NEC:	25	1500	457.2	107.0	48.5	0.42	10.7	—	8.8	262	0.772	2.2	43.0	100±15	12.0
Gray, Reel	24571235	CMP	50	1000	304.8	211.0	95.7	0.49	12.4				1.0	2.6	41.0	100±15	12.0
Gray, Reel	24571250	CEC:	100	1500	457.2	415.0	188.2	0.72	18.3				4.0	5.6	32.0	100±15	12.0
Gray, Reel	24571265	CMP	200	1000	304.8	874.0	396.4	1.04	26.3				8.0	8.5	28.0	100±15	12.0
Gray, Reel	24571266		300	1000	304.8	1234.0	559.7	1.27	32.3				10.0	9.7	26.0	100±15	12.0

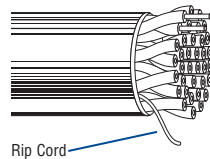

Rip Cord

Jacket sequentially marked at 2 ft. intervals. Featuring Descending Length Marking. Third party verified to TIA/EIA-568-A, Category 3

ACR = Attenuation Crosstalk Ratio • DCR = DC Resistance • ELFEXT = Equal Level Far-end Crosstalk • NEXT = Near-end Crosstalk • PSUM = Power Sum • RL = Return Loss • UTP = Unshielded Twisted Pair(s)

Color Codes: D-Series Multipair

Pair No.	Tip	Ring
1	White/Blue	Blue/White
2	White/Orange	Orange/White
3	White/Green	Green/White
4	White/Brown	Brown/White
5	White/Slate	Slate/White
6	Red/Blue	Blue/Red
7	Red/Orange	Orange/Red
8	Red/Green	Green/Red
9	Red/Brown	Brown/Red
10	Red/Slate	Slate/Red
11	Black/Blue	Blue/Black
12	Black/Orange	Orange/Black
13	Black/Green	Green/Black

Pair No.	Tip	Ring
14	Black/Brown	Brown/Black
15	Black/Slate	Slate/Black
16	Yellow/Blue	Blue/Yellow
17	Yellow/Orange	Orange/Yellow
18	Yellow/Green	Green/Yellow
19	Yellow/Brown	Brown/Yellow
20	Yellow/Slate	Slate/Yellow
21	Violet/Blue	Blue/Violet
22	Violet/Orange	Orange/Violet
23	Violet/Green	Green/Violet
24	Violet/Brown	Brown/Violet
25	Violet/Slate	Slate/Violet



Riser Multipair Armored UTP Cable

TIA/EIA-568-A and CSA T529-95, Category 3

Category 3 Nonbonded-pair Cables

Description	Part No.	UL NEC/ C(UL) CEC Type	No. of Pairs	Standard Lengths		Standard Unit Wt.		Nominal OD		Max. DCR ($\Omega/100m$)	Max. DCR Unbal. (%)	Max. Cap. Unbal. (pF/100m)	Freq. (MHz)	Max. Atten. (dB/100m)	Min. PSUM NEXT (dB)	Input Imped. (Ω)	Min. SRL (dB)
				Ft.	m	Lbs.	kg	Inch	mm								

24 AWG Solid Bare Copper Conductors • Twisted Pairs • Rip Cord • See Color Code Chart (below)

Non-Plenum • Dual Insulation: Polyolefin/PVC • ALVYAN Sheath • Gray PVC Jacket

Gray, Reel	22713010	NEC:	25	Variable Length	132.0	59.9	0.47	11.9	—	8.8	262	0.772	2.2	43.0	102±15	12.0
Gray, Reel	22713020	CMR	50	Variable Length	239.0	108.4	0.66	16.7				1.0	2.6	41.0	102±15	12.0
Gray, Reel	22713030	CEC:	100	Variable Length	421.0	191.0	0.85	21.5				4.0	5.6	32.0	102±15	12.0
Gray, Reel	22713035	CMR	105	Variable Length	610.0	276.7	0.99	25.3				8.0	8.5	28.0	102±15	12.0
Gray, Reel	22713040		200	Variable Length	766.0	347.5	1.10	28.0				10.0	9.7	26.0	102±15	12.0
Gray, Reel	22713045		250	Variable Length	940.0	426.4	1.22	31.0				16.0	13.1	23.0	102±15	10.0
Gray, Reel	22713050		300	Variable Length	1111.0	503.9	1.32	33.5								
Gray, Reel	22713060		400	Variable Length	1453.0	659.1	1.50	38.0								
Gray, Reel	22713070		600	Variable Length	2146.0	973.4	1.84	46.8								
Gray, Reel	22713080		900	Variable Length	3204.0	1453.3	2.25	57.1								
Gray, Reel	22713090		1200	Variable Length	4216.0	1912.3	2.56	65.1								

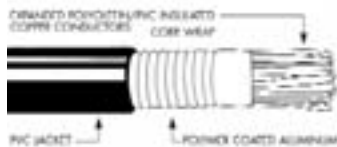

Jacket sequentially marked at 2 ft. intervals.
Third party verified to TIA/EIA-568-A, Category 3

ACR = Attenuation Crosstalk Ratio • DCR = DC Resistance • ELFEXT = Equal Level Far-end Crosstalk • NEXT = Near-end Crosstalk • PSUM = Power Sum • RL = Return Loss • UTP = Unshielded Twisted Pair(s)

Color Codes: Riser Multipair

Pair No.	Tip	Ring	Binder group
1	White	Blue	White/Blue
2	White	Orange	White/Orange
3	White	Green	White/Green
4	White	Brown	White/Brown
5	White	Slate	White/Slate
6	Red	Blue	Red/Blue
7	Red	Orange	Red/Orange
8	Red	Green	Red/Green
9	Red	Brown	Red/Brown
10	Red	Slate	Red/Slate
11	Black	Blue	Black/Blue
12	Black	Orange	Black/Orange
13	Black	Green	Black/Green
14	Black	Brown	Black/Brown
15	Black	Slate	Black/Slate
16	Yellow	Blue	Yellow/Blue
17	Yellow	Orange	Yellow/Orange
18	Yellow	Green	Yellow/Green
19	Yellow	Brown	Yellow/Brown
20	Yellow	Slate	Yellow/Slate
21	Violet	Blue	Violet/Blue
22	Violet	Orange	Violet/Orange
23	Violet	Green	Violet/Green
24	Violet	Brown	Violet/Brown
25	Violet	Slate	Violet/Slate



DataTwist® 5e ScTP Cable

TIA/EIA-568-B.2, Category 5e Nonbonded-Pair Cables

Description	Part No.	UL NEC/ C(UL) CEC Type	No. of Pairs	Standard Lengths		Standard Unit Wt.		Nominal OD		Max. DCR (Ω/100m)	Max. DCR Unbal. (%)	Max. Cap. Unbal. (pF/100m)	Freq. (MHz)	Max. Atten. (dB/100m)	Min. PSUM NEXT (dB)	Min. PSUM ACR (dB/100m)	Min. PSUM ELFEXT (dB/100m)	Input Imped. (Ω)	Min. RL (dB)
				Ft.	m	Lbs.	kg	Inch	mm										

24 AWG Solid Bare Copper Conductors • Twisted Pairs • Overall Beldfoil® Shield • Drain Wire* • RJ-45 Compatible • See Color Code Chart (below)

Non-Plenum • Polyolefin Insulation • PVC Jacket (Available in Red, Orange, Yellow, Green, Blue, Gray or Black)

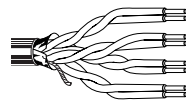
Description	Part No.	UL NEC/ C(UL) CEC Type	No. of Pairs	Standard Lengths		Standard Unit Wt.		Nominal OD		Max. DCR (Ω/100m)	Max. DCR Unbal. (%)	Max. Cap. Unbal. (pF/100m)	Freq. (MHz)	Max. Atten. (dB/100m)	Min. PSUM NEXT (dB)	Min. PSUM ACR (dB/100m)	Min. PSUM ELFEXT (dB/100m)	Input Imped. (Ω)	Min. RL (dB)
				Ft.	m	Lbs.	kg	Inch	mm										
	1533R	NEC: CMR CEC: CMR CMR	4	1000	304.8	34.0	15.5	.260	6.60	9.38	3.0	330	1	2.0	62.3	60	60.8	100±15	20.0
				A-1000	A-304.8	37.0	16.8	4	4.1	53.3	49	48.7	100±15	23.0					
				1640†	500.0	57.4	26.1	8	5.8	48.8	43	42.7	100±15	24.5					
				10	6.5	47.3	41	40.8	100±15	25.0									
				16	8.2	44.3	36	36.7	100±15	25.0									
				20	9.3	42.8	34	34.7	100±15	25.0									
				25	10.4	41.3	31	32.8	100±15	24.3									
				31.25	11.7	39.9	28	30.9	100±15	23.6									
				62.5	17.0	35.4	18	24.8	100±15	21.5									
				100	22.0	32.3	10	20.8	100±15	20.1									

†1640 ft. put-up available in Gray only.

Shield is bonded to jacket inner wall for electrical stability.

Jacket sequentially marked at 2 ft. intervals. • Third party verified to TIA/EIA-568-B.2, Category 5e

Non-Plenum • Polypropylene Insulation (Color Code: See Chart Below) • Black Low-Smoke, Zero-Halogen Jacket

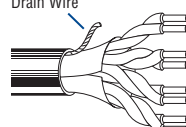
Description	Part No.	UL NEC/ C(UL) CEC Type	No. of Pairs	Standard Lengths		Standard Unit Wt.		Nominal OD		Max. DCR (Ω/100m)	Max. DCR Unbal. (%)	Max. Cap. Unbal. (pF/100m)	Freq. (MHz)	Max. Atten. (dB/100m)	Min. PSUM NEXT (dB)	Min. PSUM ACR (dB/100m)	Min. PSUM ELFEXT (dB/100m)	Input Imped. (Ω)	Min. RL (dB)
				Ft.	m	Lbs.	kg	Inch	mm										
	1300SB <small>new</small>	NEC: CMG-LS CEC: CMG-LS FT4 Limited Smoke	4	1000	304.8	35.0	15.9	.260	6.60	9.3	3.0	330	1	2.0	62.3	60	60.8	100±15	20.0
				A-1000	A-304.8	37.0	16.8	4	4.1	53.3	49	48.7	100±15	23.0					
				10	6.5	47.3	41	40.8	100±15	24.5									
				16	8.2	44.3	36	36.7	100±15	25.0									
				20	9.3	42.8	34	34.7	100±15	25.0									
				25	10.4	41.3	31	32.8	100±15	24.3									
				31.25	11.7	39.9	28	30.9	100±15	23.6									
				62.5	17.0	35.4	18	24.8	100±15	21.5									
				100	22.0	32.3	10	20.8	100±15	20.1									

LSZH and ABS Type Approved

Jacket sequentially marked at 2 ft. intervals.

Plenum • FEP Teflon® Insulation • Flamarrest® Jacket (Available in Red, Orange, Yellow, Green, Blue, Gray, Black or Natural)

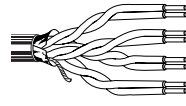
Description	Part No.	UL NEC/ C(UL) CEC Type	No. of Pairs	Standard Lengths		Standard Unit Wt.		Nominal OD		Max. DCR (Ω/100m)	Max. DCR Unbal. (%)	Max. Cap. Unbal. (pF/100m)	Freq. (MHz)	Max. Atten. (dB/100m)	Min. PSUM NEXT (dB)	Min. PSUM ACR (dB/100m)	Min. PSUM ELFEXT (dB/100m)	Input Imped. (Ω)	Min. RL (dB)
				Ft.	m	Lbs.	kg	Inch	mm										
	1533P	NEC: CMP CEC: CMP CMP	4	1000	304.8	35.0	15.9	.235	6.00	9.38	3.0	330	1	2.0	62.3	60	60.8	100±15	20.0
				A-1000	A-304.8	38.0	17.2	4	4.1	53.3	49	48.7	100±15	23.0					
				10	6.5	47.3	41	40.8	100±15	24.5									
				16	8.2	44.3	36	36.7	100±15	25.0									
				20	9.3	42.8	34	34.7	100±15	25.0									
				25	10.4	41.3	31	32.8	100±15	24.3									
				31.25	11.7	39.9	28	30.9	100±15	23.6									
				62.5	17.0	35.4	18	24.8	100±15	21.5									
				100	22.0	32.3	10	20.8	100±15	20.1									

Shield is bonded to jacket inner wall for electrical stability.

Jacket sequentially marked at 2 ft. intervals.

Third party verified to TIA/EIA-568-B.2, Category 5e

ACR = Attenuation Crosstalk Ratio • DCR = DC Resistance • ELFEXT = Equal Level Far-end Crosstalk • NEXT = Near-end Crosstalk • PSUM = Power Sum • RL = Return Loss
ScTP = Screened (Overall Foil) Twisted Pair(s)

*Drain wire is 24 AWG stranded tinned copper.

Color Codes: DataTwist 5e ScTP

Pair No.	Color Combination
1	White/Blue Stripe & Blue
2	White/Orange Stripe & Orange
3	White/Green Stripe & Green
4	White/Brown Stripe & Brown

Teflon is a DuPont trademark.



For more information, contact Belden Technical Support: 1-800-BELDEN-1 • www.belden.com

DataTwist® 5 ScTP Cable

TIA/EIA-568-A, Category 5 Nonbonded-Pair Cables

Description	Part No.	UL NEC/ C(UL) CEC Type	No. of Pairs	Standard Lengths		Standard Unit Wt.		Nominal OD		Max. DCR (Ω/ 100m)	Max. DCR Unbal. (%)	Max. Cap. Unbal. (pF/ 100m)	Freq. (MHz)	Max. Atten. (dB/ 100m)	Min. PSUM NEXT (dB)	Input Imped. (Ω)	Min. SRL (dB)
				Ft.	m	Lbs.	kg	Inch	mm								

24 AWG Solid Bare Copper Conductors • Twisted Pairs • Overall Beldfoil® Shield • Drain Wire* • RJ-45 Compatible • See Color Code Chart (below)

Non-Plenum • Polyolefin Insulation • PVC Jacket (Available in Red, Orange, Yellow, Green, Blue, Purple or Light Gray)

Part No.	UL NEC/ C(UL) CEC Type	No. of Pairs	Standard Lengths (Ft./m)	Standard Unit Wt. (Lbs./kg)	Nominal OD (Inch/mm)	Max. DCR (Ω/ 100m)	Max. DCR Unbal. (%)	Max. Cap. Unbal. (pF/ 100m)	Freq. (MHz)	Max. Atten. (dB/ 100m)	Min. PSUM NEXT (dB)	Input Imped. (Ω)	Min. SRL (dB)			
1624R	NEC:	4	1000	304.8	33.0	15.0	.260	6.60	9.38	3.0	300	1	2.0	62.3	100±15	23.0
	CMR	A-1000	A-304.8	36.0	16.3							4	4.1	53.3	100±15	23.0
	CEC:	1640†	500.0	54.1	24.7							8	5.8	48.8	100±15	23.0
	CMR											10	6.5	47.3	100±15	23.0
												16	8.2	44.3	100±15	23.0
												20	9.3	42.8	100±15	23.0
												25	10.4	41.3	100±15	22.0
												31.25	11.7	39.9	100±15	21.1
												65.5	17.0	35.4	100±15	18.0
												100	22.0	32.3	100±15	16.0

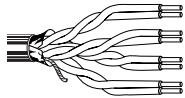

†1640 ft. put-up available in Gray only.
Shield is bonded to jacket inner wall for electrical stability.
Jacket sequentially marked at 2 ft. intervals. • Third party verified to TIA/EIA-568-A, Category 5

Plenum • FEP Teflon® Insulation • Flamarrest® Jacket (Available in Red, Orange, Yellow, Green, Blue, Purple, Gray or Natural)

Part No.	UL NEC/ C(UL) CEC Type	No. of Pairs	Standard Lengths (Ft./m)	Standard Unit Wt. (Lbs./kg)	Nominal OD (Inch/mm)	Max. DCR (Ω/ 100m)	Max. DCR Unbal. (%)	Max. Cap. Unbal. (pF/ 100m)	Freq. (MHz)	Max. Atten. (dB/ 100m)	Min. PSUM NEXT (dB)	Input Imped. (Ω)	Min. SRL (dB)			
1624P	NEC:	4	1000	304.8	32.0	14.5	.230	5.84	9.38	3.0	300	1	2.0	62.3	100±15	23.0
	CMP	A-1000††	A-304.8	35.0	15.9							4	4.1	53.3	100±15	23.0
	CEC:											8	5.8	48.8	100±15	23.0
	CMP											10	6.5	47.3	100±15	23.0
												16	8.2	44.3	100±15	23.0
												20	9.3	42.8	100±15	23.0
												25	10.4	41.3	100±15	22.0
												31.25	11.7	39.9	100±15	21.1
												65.5	17.0	35.4	100±15	18.0
												100	22.0	32.3	100±15	16.0

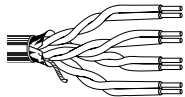

††A-1000 ft. put-up available in Yellow, Blue, Gray or Natural only.
Shield is bonded to jacket inner wall for electrical stability.
Jacket sequentially marked at 2 ft. intervals.
Third party verified to TIA/EIA-568-A, Category 5

DCR = DC Resistance • NEXT = Near-end Crosstalk • PSUM = Power Sum • RL = Return Loss • ScTP = Screened (Overall Foil) Twisted Pair(s)

*Drain wire is 24 AWG stranded tinned copper on 1624R and 24 AWG solid tinned copper on 1624P.

Color Codes: DataTwist 5 ScTP

Pair No.	Color Combination
1	White/Blue Stripe & Blue
2	White/Orange Stripe & Orange
3	White/Green Stripe & Green
4	White/Brown Stripe & Brown



DataTwist® 5 ScTP Cable

TIA/EIA-568-TSB 36, Category 5 Nonbonded-Pair Cables

Description	Part No.	UL NEC/ C(UL) CEC Type	No. of Pairs	Standard Lengths		Standard Unit Wt.		Nominal OD		Max. DCR (Ω / 100m)	Max. DCR Unbal. (%)	Max. Cap. Unbal. (pF/ 100m)	Freq. (MHz)	Max. Atten. (dB/ 100m)	Min. NEXT (dB)	Input Imped. (Ω)	Min. RL (dB)
				Ft.	m	Lbs.	kg	Inch	mm								

24 AWG Solid Bare Copper Conductors • Twisted Pairs • Overall Beldfoil® Shield • Drain Wire • Rip Cord • See Color Code Chart (below)

Non-Plenum • Polyolefin Insulation • PVC Jacket (Available in Gray or Blue)

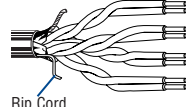
 <p>Rip Cord</p>	1633A NEC: CM CEC: CM	4	U-1000	U-304.8	30.0	13.6	.260	6.60	9.38	5.0	330	4	4.1	53.0	100±15	N/A			
			1000	304.8	32.0	14.5								10	6.5	47.0	100±15	N/A	
															16	8.2	44.0	100±15	N/A
															31.25	11.7	40.0	100±15	N/A
															62.5	17.0	35.0	100±15	N/A
															100	22.0	32.0	100±15	N/A

Not compatible with RJ-11/12/45 connectors.
 Jacket sequentially marked at 2 ft. intervals.
 Third party verified to TIA/EIA-568-TSB 36, Category 5

Non-Plenum • Dual • Polyolefin Insulation • Gray PVC Jacket with Polarity Rib

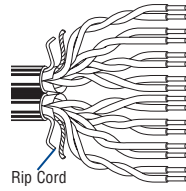
 <p>Rip Cord</p>	1668A NEC: CM CEC: CM	2x4	1000	304.8	70.0	31.8	.518	13.16	9.38	5.0	330	4	4.1	53.0	100±15	N/A			
			1640	500.0	109.9	49.9	x	x						10	6.5	47.0	100±15	N/A	
									.254	6.45					16	8.2	44.0	100±15	N/A
															31.25	11.7	40.0	100±15	N/A
															62.5	17.0	35.0	100±15	N/A
															100	22.0	32.0	100±15	N/A

Not compatible with RJ-11/12/45 connectors.
 Jacket sequentially marked at 2 ft. intervals.
 Third party verified to TIA/EIA-568-TSB 36, Category 5 (Leg 1 & 2). A polarity rib is applied to one leg.

DCR = DC Resistance • NEXT = Near-end Crosstalk • PSUM = Power Sum • RL = Return Loss • ScTP = Screened (Overall Foil) Twisted Pair(s)

Color Codes: DataTwist 5 ScTP

Pair No.	Color Combination
1	White/Blue Stripe & Blue
2	White/Orange Stripe & Orange
3	White/Green Stripe & Green
4	White/Brown Stripe & Brown

VideoTwist® 6 UTP Cable for RGB Video

TIA/EIA-568-B.2-1, Category 6 Bonded-Pair Cables

Description	Part No.	UL NEC/ C(UL) CEC Type	No. of Pairs	Standard Lengths		Standard Unit Wt.		Nominal OD		Max. DCR (Ω/ 100m)	Max. DCR Unbal. (%)	Max. Cap. Unbal. (pF/ 100m)	Freq. (MHz)	Max. Atten. (dB/ 100m)	Min. PSUM NEXT (dB)	Min. PSUM ACR (dB/ 100m)	Min. PSUM ELFEXT (dB/ 100m)	Input Imped. (Ω)	Min. RL (dB)
				Ft.	m	Lbs.	kg	Inch	mm										

23 AWG Bonded-Pairs Solid BC Conductors • Twisted Pairs • Rip Cord • See Color Code Chart (below)

Non-Plenum • Polypropylene Insulation • PVC Jacket

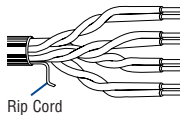
 <p>Rip Cord</p>	7989R	NEC:	4	1000	304.8	32.0	14.5	.365	9.27	9.0	3.0	49.2	1	2.0	72.3	70.3	64.8	100±15	20.0
		CMR		1640	500.0	52.5	23.8		x	x			4	3.8	63.3	59.5	52.7	100±15	23.0
		CEC:							.165	.412			10	6.0	57.3	51.3	44.8	100±15	25.0
		CMG											16	7.6	54.3	46.7	40.7	100±15	25.0
													31.25	10.7	49.9	39.2	34.9	100±15	23.6
													62.5	15.4	45.4	30.0	28.8	100±15	21.5
													100	19.8	42.3	22.5	24.8	100±15	20.1
													200	29.0	37.8	8.8	18.7	100±22	18.0
													250	32.8	36.3	3.5	16.8	100±32	17.3

Jacket sequentially marked at 2 ft. intervals. Third party verified to TIA/EIA-568-B.2, Category 6

Plenum • FEP Insulation • Flamarrest® Jacket

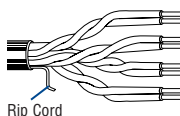
 <p>Rip Cord</p>	7989P	NEC:	4	1000	304.8	38.0	17.2	.365	9.27	9.0	3.0	49.2	1	2.0	72.3	70.3	64.8	100±15	20.0
		CMP		1640	500.0	62.3	28.3		x	x			4	3.8	63.3	59.5	52.7	100±15	23.0
		CEC:							.165	.412			10	6.0	57.3	51.3	44.8	100±15	25.0
		CMP											16	7.6	54.3	46.7	40.7	100±15	25.0
													31.25	10.7	49.9	39.2	34.9	100±15	23.6
													62.5	15.4	45.4	30.0	28.8	100±15	21.5
													100	19.8	42.3	22.5	24.8	100±15	20.1
													200	29.0	37.8	8.8	18.7	100±22	18.0
													250	32.8	36.3	3.5	16.8	100±32	17.3

Jacket sequentially marked at 2 ft. intervals. Third party verified to TIA/EIA-568-B.2-1, Category 6

ACR = Attenuation Crosstalk Ratio • BC = Bare Copper • DCR = DC Resistance • ELFEXT = Equal Level Far-end Crosstalk • NEXT = Near-end Crosstalk • PSUM = Power Sum • RL = Return Loss • UTP = Unshielded Twisted Pair(s)

Color Codes: VideoTwist 6 RGB

Pair No.	Color Combination
1	White/Blue Stripe & Blue
2	White/Orange Stripe & Orange
3	White/Green Stripe & Green
4	White/Brown Stripe & Brown



DataTwist® 5e UTP Cable for RGB Video

TIA/EIA-568-B.2, Category 5e Bonded and Nonbonded-Pair Cables

Description	Part No.	UL NEC/ C(UL) CEC Type	No. of Pairs	Standard Lengths		Standard Unit Wt.		Nominal OD		Max. DCR (Ω/ 100m)	Max. DCR Unbal. (%)	Max. Cap. Unbal. (pF/ 100m)	Freq. (MHz)	Max. Atten. (dB/ 100m)	Min. PSUM NEXT (dB)	Min. PSUM ACR (dB/ 100m)	Min. PSUM ELFEXT (dB/ 100m)	Input Imped. (Ω)	Min. RL (dB)
				Ft.	m	Lbs.	kg	Inch	mm										

Low Skew 24 AWG Bonded Pairs Solid BC Conductors • Twisted Pairs • Skew 9.0ns/100m nom. • Rip Cord • See Color Code Chart

Non-Plenum • Polyolefin Insulation • Green PVC Jacket

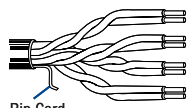
 <p>Rip Cord</p>	7988R	NEC: CMR CEC: CMG	4	U-1000 U-1640	U-304.8 U-500.0	22.0 36.1	10.0 16.4	.204	5.18	9.0	3.0	66.0	1 4 10 16 31.25 62.5 100 200	2.0 4.1 6.5 8.2 11.7 17.0 22.0 32.4	65.3 53.3 47.3 44.3 39.9 35.4 32.3 27.8	60.3 49.2 40.8 36.0 28.2 18.4 10.3 1.0	60.8 48.7 40.8 36.7 30.9 24.8 20.8 14.7	100±15 100±15 100±15 100±15 100±15 100±15 100±15 100±25	20.0 23.0 25.0 25.0 23.6 21.5 20.1 15.0
---	--------------	----------------------------	---	------------------	--------------------	--------------	--------------	------	------	-----	-----	------	---	--	--	---	--	--	--

Jacket sequentially marked at 2 ft. intervals. Third party verified to TIA/EIA-568-B.2, Category 5e

Plenum • FEP Insulation • Green Flamarrest® Jacket

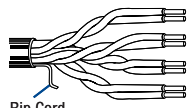
 <p>Rip Cord</p>	7988P	NEC: CMP CEC: CMP	4	U-1000 U-1640	U-304.8 U-500.0	23.0 37.7	10.4 17.1	.193	4.90	9.0	3.0	66.0	1 4 10 16 31.25 62.5 100 200	2.0 4.1 6.5 8.2 11.7 17.0 22.0 32.4	65.3 53.3 47.3 44.3 39.9 35.4 32.3 27.8	60.3 49.2 40.8 36.0 28.2 18.4 10.3 1.0	60.8 48.7 40.8 36.7 30.9 24.8 20.8 14.7	100±15 100±15 100±15 100±15 100±15 100±15 100±15 100±25	20.0 23.0 25.0 25.0 23.6 21.5 20.1 15.0
---	--------------	----------------------------	---	------------------	--------------------	--------------	--------------	------	------	-----	-----	------	---	--	--	---	--	--	--

Jacket sequentially marked at 2 ft. intervals. Third party verified to TIA/EIA-568-B.2, Category 5e

ACR = Attenuation Crosstalk Ratio • BC = Bare Copper • DCR = DC Resistance • ELFEXT = Equal Level Far-end Crosstalk • NEXT = Near-end Crosstalk • PSUM = Power Sum • RL = Return Loss • UTP = Unshielded Twisted Pair(s)

Color Codes: DataTwist 5e RGB

Pair No.	Color Combination
1	White/Blue Stripe & Blue
2	White/Orange Stripe & Orange
3	White/Green Stripe & Green
4	White/Brown Stripe & Brown



MediaTwist® and DataTwist® 6 UTP Patch Cables

TIA/EIA-568-B.2-1, Category 6

Enhanced Category 6 Bonded-Pair Cables

Description	Part No.	UL NEC/ C(UL) CEC Type	No. of Pairs	Standard Lengths		Standard Unit Wt.		Nominal OD		Max. DCR (Ω/100m)	Max. DCR Unbal. (%)	Max. Cap. Unbal. (pF/100m)	Freq. (MHz)	Max. Atten. (dB/100m)	Min. PSUM NEXT (dB)	Min. PSUM ACR (dB/100m)	Min. PSUM ELFEXT (dB/100m)	Input Imped. (Ω)	Min. RL (dB)
				Ft.	m	Lbs.	kg	Inch	mm										

Patch Cables • 24 AWG Bonded-Pairs Stranded (7x32) Tinned Copper Conductor • RJ-45 Compatible • See Color Code Chart (below)▲

Non-Plenum • Polyolefin Insulation • PVC Jacket (Yellow, Green, Blue, Purple, Light Gray, Gray, White or Black)

Part No.	UL NEC/C(UL) CEC Type	No. of Pairs	1000†	304.8	31.0	14.1	.365	9.27	9.0	3.0	49.2	1	1.9	72.3	70	64.8	100±12	20.0	
1875GB	CMR	4	A-1000††	A-304.8	32.0	14.5	x	x				4	3.7	63.3	59	52.8	100±12	23.0	
	CEC:												8	5.3	58.8	53	46.7	100±12	24.5
	CMR												10	5.9	57.3	51	44.8	100±12	25.0
													16	7.5	54.3	46	40.7	100±12	25.0
													25	9.5	51.4	42	36.8	100±15	24.3
													31.25	10.6	49.9	39	34.9	100±15	23.6
													62.5	15.4	45.4	30	28.9	100±15	21.5
													100	19.8	42.3	25	24.8	100±15	21.0
													155	25.1	39.5	14	20.9	100±15	21.0
													200	29.0	37.8	10	18.8	100±15	21.0
													250	32.8	36.3	3	16.8	100±20	18.0
											300	35.2	35.2	>0	15.2	100±20	18.0		
											350	39.8	34.2	—	13.9	100±22	17.0		
											400	43.0	—	—	—	100±32	14.0		
											500	49.0	—	—	—	100±32	14.0		

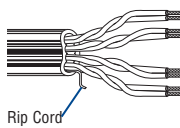

†1000 ft. put-up not available in Purple.
 ††A-1000 ft. put-up not available in Black.
 U.S. Patents 5,606,151; 5,734,126; 5,763,823 and 5,821,467
 Third party verified to TIA/EIA-568-B.2-1, Category 6 Patch

Patch Cables • 24 AWG Solid BC Conductors • Twisted Pairs • Central Slit-Film Filler • RJ-45 Compatible* • See Color Code Chart (below)▲

Non-Plenum • Polyolefin Insulation • PVC Jacket (Available in Red, Orange, Yellow, Green, Blue, Purple, Gray, White or Black)

Part No.	UL NEC/C(UL) CEC Type	No. of Pairs	1000	304.8	24.0	10.9	.205	5.21	9.38	5.0	330	1	2.4	72.3	69.9	64.8	100±15	20.0	
7883A	CM	4										10	7.1	57.3	50.2	44.8	100±15	25.0	
	CEC:												20	10.2	52.8	42.6	38.8	100±15	25.0
	CM												31.25	12.8	49.9	37.1	34.9	100±15	23.6
													62.5	18.5	45.4	26.9	28.9	100±15	21.5
													100	23.8	42.3	18.5	24.8	100±15	20.1
													200	34.8	37.8	3.0	18.8	100±22	18.0
											250	39.4	36.3	—	16.8	100±32	17.3		

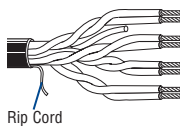

Jacket sequentially marked at 2 ft. intervals.
 Third party verified to TIA/EIA-568-B.2-1, Category 6 Patch

ACR = Attenuation Crosstalk Ratio • DCR = DC Resistance • ELFEXT = Equal Level Far-end Crosstalk • NEXT = Near-end Crosstalk • PSUM = Power Sum • RL = Return Loss • UTP = Unshielded Twisted Pair(s)

Color Codes: MediaTwist Patch (1875GB)

Pair No.	Color Combination
1	White/Brown Stripe & Brown
2	White/Blue Stripe & Blue
3	White/Green Stripe & Green
4	White/Orange Stripe & Orange

*Color rotation available for T568-A or T568-B wiring schemes.

Color Codes: DataTwist 6 Patch (7883A)

Pair No.	Color Combination
1	White/Blue Stripe & Blue
2	White/Orange Stripe & Orange
3	White/Green Stripe & Green
4	White/Brown Stripe & Brown

*Color rotation available for T568-A or T568-B wiring schemes.

Handy Cable Preparation Tool for Bonded-Pairs

See page 15.40 for details.

(Part No. 1797B)



DataTwist® 350 UTP Patch Cable

TIA/EIA-568-B.2, Category 5e

Enhanced Category 5e Bonded-Pair Cables

Description	Part No.	UL NEC/ C(UL) CEC Type	No. of Pairs	Standard Lengths		Standard Unit Wt.		Nominal OD		Max. DCR (Ω/ 100m)	Max. DCR Unbal. (%)	Max. Cap. Unbal. (pF/ 100m)	Freq. (MHz)	Max. Atten. (dB/ 100m)	Min. PSUM NEXT (dB)	Min. PSUM ACR (dB/ 100m)	Min. PSUM ELFEXT (dB/ 100m)	Input Imped. (Ω)	Min. RL (dB)
				Ft.	m	Lbs.	kg	Inch	mm										

24 AWG Bonded-Pairs Stranded (7x32) Tinned Copper Conductors • RJ-45 Compatible • See Color Code Chart (below)

Non-Plenum • Polyolefin Insulation • PVC Jacket (Available in Red, Orange, Yellow, Green, Blue, Purple, Black or Gray)

Part No.	UL NEC/ C(UL) CEC Type	No. of Pairs	Standard Lengths (Ft./m)	Standard Unit Wt. (Lbs./kg)	Nominal OD (Inch/mm)	Max. DCR (Ω/100m)	Max. DCR Unbal. (%)	Max. Cap. Unbal. (pF/100m)	Freq. (MHz)	Max. Atten. (dB/100m)	Min. PSUM NEXT (dB)	Min. PSUM ACR (dB/100m)	Min. PSUM ELFEXT (dB/100m)	Input Imped. (Ω)	Min. RL (dB)							
1752A	NEC: CM CEC: CM	4	U-1000	U-304.8	24.0	10.9	.220	5.59	9.0	3.0	66.0	1	2.4	65.3	62.9	60.8	100±12	20.0				
			1000	304.8	26.0	11.8																

Jacket sequentially marked at 2 ft. intervals.
 U.S. Patents 5,606,151; 5,734,126 and 5,763,823
 Third party verified to TIA/EIA-568-B.2, Category 5e Patch

ACR = Attenuation Crosstalk Ratio • DCR = DC Resistance • ELFEXT = Equal Level Far-end Crosstalk • NEXT = Near-end Crosstalk • PSUM = Power Sum • RL = Return Loss • UTP = Unshielded Twisted Pair(s)

Color Codes: DataTwist 350 Patch

Pair No.	Color Combination
1	White/Blue Stripe & Blue
2	White/Orange Stripe & Orange
3	White/Green Stripe & Green
4	White/Brown Stripe & Brown

Get the Bonded-Pairs Cable Preparation Tool
 See page 15.40 for details.
 (Part No. 1797B)



IEEE 802.3 • ISO/IEC 8802.3 10Base2 and 10Base5 Trunk Cables — Thinnet and Thicknet

Description	Part No.	UL NEC/ C(UL) CEC Type	Standard Lengths		Standard Unit Weight		Conductor (stranding) Diameter Nom. DCR	Nominal Core OD		Shielding Materials Nom. DCR	Nominal OD		Nom. Imp. (Ω)	Nom. Vel. of Prop.	Nominal Capacitance		Nominal Attenuation		
			Ft.	m	Lbs.	kg		Inch	mm		Inch	mm			pF/Ft.	pF/m	MHz	dB/ 100 Ft.	dB/ 100m

Thinnet 10Base2 • 20 AWG Stranded (19x32) .037" Tinned Copper Conductors • Duobond® II + Tinned Copper Braid Shield (93% Coverage)

Non-Plenum • Ethernet • Foam HDPE Insulation • Gray PVC Jacket																							
UL AWM Style 1354 (30V 60°C)		9907	NEC:	500	152.4	12.5	5.7	20 AWG (19x32)	.102	2.59	Duobond II + 93% Tinned Copper Braid	.185	4.70	50	80%	25.4	83.3	1	.43	1.4			
CL2, CM			U-1000	U-304.8	25.0	11.4													10	1.30	4.3		
CEC:			1000	304.8	25.0	11.4														50	2.90	9.5	
CM			1640	500.0	41.0	18.6														100	4.20	13.8	
			2500	762.0	62.5	28.4														200	6.10	20.0	
			3280	1000.0	82.0	37.3														400	8.90	29.2	
													For Plenum versions of 9907, see 89907 or 82907.		700	12.10	39.7	900	13.90	45.6	1000	14.80	48.6

DEC Part No. 17-01248-00

Plenum Ethernet • Foam FEP Insulation • Natural Flamarrest® Jacket																						
300V 75°C		82907	NEC:	500†	152.4	12.5	5.7	20 AWG (19x32)	.095	2.41	Duobond II + 93% Tinned Copper Braid	.160	4.06	50	80%	25.4	83.3	1	.43	1.4		
CL2P,			U-1000	U-304.8	23.0	10.9													10	1.30	4.3	
CMP:			1000†	304.8	24.0	10.9														50	2.90	9.5
CEC:			2500†	762.0	57.5	26.1														100	4.20	13.8
CMP																				200	6.10	20.0
																				400	9.20	30.2
													700	12.90	42.3	900	15.00	49.2	1000	16.00	52.5	

Plenum Ethernet • Foam FEP Insulation • Gray Fluorocopolymer Jacket

300V 150°C		89907†	NEC:	500†	152.4	12.5	5.7	20 AWG (19x32)	.095	2.41	Duobond II + 93% Tinned Copper Braid	.160	4.06	50	80%	25.4	83.3	1	.43	1.4		
CL2P,			1000†	304.8	24.0	10.9													10	1.30	4.3	
CMP:			2500†	762.0	60.0	27.3														50	2.90	9.5
CEC:																				100	4.20	13.8
CMP																				200	6.10	20.0
																				400	9.20	30.2
													700	12.90	42.3	900	15.00	49.2	1000	16.00	52.5	

DEC Part No. 17-01246-00

Suitable for Outdoor and Direct Burial applications.

Thicknet 10Base5 • 12 AWG Solid .086" Bare Copper Conductor • Duobond IV* Quad Shield (100% Coverage)

Non-Plenum • Ethernet • Foam Polyethylene Insulation • Yellow PVC Jacket																										
UL AWM Style 1478 (30V 60°C)		9880	NEC:	500	152.4	66.0	30.0	12 AWG (solid)	.243	6.17	Duobond IV (Duobond II + 94% TC Braid + Duofoil® + 90% TC Braid)	.405	10.29	50	78%	26.0	85.0	1	.19▲	.62						
CL2, CM			1000	304.8	131.0	59.5													5	.37▲	1.21					
CEC:			1640	500.0	219.8	99.9														10	.52▲	1.71				
CM																				50	1.20▲	3.94				
																				100	1.70▲	5.58				
																				200	2.55▲	8.37				
													For Plenum version of 9880, see 89880.		400	3.90▲	12.80	700	5.50▲	18.10	900	6.50▲	21.30	1000	6.90▲	22.60

DEC Part No. 17-00451-00

Ring-band stripes marked every 2.5 meters to aid users in tap placement.

Plenum Ethernet • Foam FEP Insulation • Orange Fluorocopolymer Jacket																								
150°C		89880	NEC:	1000†	304.8	134.0	60.9	12 AWG (solid)	.245	6.22	Duobond IV (Duobond II + 94% TC Braid + Duofoil® + 90% TC Braid)	.375	9.53	50	78%	26.0	85.0	1	.18	.59				
CL2P,			1640†	500.0	224.7	102.1													5	.37▲	1.21			
CMP:																				10	.52▲	1.71		
CEC:																				50	1.15	3.77		
CMP																				100	1.65	5.41		
																				200	2.45	8.04		
													400	3.80	12.50	700	5.60	18.40	900	6.80	22.30	1000	7.20	23.60

DEC Part No. 17-00324-00

Suitable for Outdoor and Direct Burial applications.

Ring-band stripes marked every 2.5 meters to aid users in tap placement.

DCR = DC Resistance • HDPE = High-density Polyethylene • TC = Tinned Copper

* Duobond IV = Duobond II (100% coverage) + tinned copper braid (90% coverage) + Duofoil® (100% coverage) + tinned copper braid (90% coverage).

Plenum version is Duobond II (100% coverage) + tinned copper braid (94% coverage) + Duofoil (100% coverage) + tinned copper braid (90% coverage).

† Spools are one piece, but length may vary ±10% from length shown.

▲Maximum Attenuation

Not RoHS compliant at time of printing. Please check with Belden Technical Support for current compliance information at 1-800-BELDEN-1.

IEEE 802.3 • ISO/IEC 8802.3 10Base5

Transceiver Cables

Description	Part No.	UL NEC/ C(UL) CEC Type	No. of Pairs	Color Code	Standard Lengths		Standard Unit Wt.		Conductor (stranding) Nom. DCR	Shielding Materials Nom. DCR	Nominal OD		Drain Wire	Nom. Imp. (Ω)	Nom. Vel. of Prop.	Nominal Capacitance			
					Ft.	m	Lbs.	kg			Inch	mm				* pF/Ft.	* pF/m	** pF/Ft.	** pF/m

28 and 24 AWG Stranded TC Conductors • Twisted Pairs • Overall Polyester Isolation Tape + Duofoil® + TC Braid Shield (92% Coverage) • Drain Wire

Non-Plenum • Polypropylene Insulation • Light Gray PVC Jacket

UL AWM Style 2919 (30V 80°C)	9903	NEC: CMG CEC: CMG CMG	4	Gray/White, Yellow/Orange, Blue/Green, Black/Red	500 1000	152.4 304.8	21.5 43.0	9.8 19.5	3 Pair: 28 AWG (7x36) TC 65.0Ω/M' 213.0Ω/km 1 Pair: 24 AWG (7x32) TC 24.0Ω/M' 78.7Ω/km Each Pair Individually Beldfoil® Shielded	Polyester Isolation Tape + Duofoil® + 92% Tinned Copper Braid 9.5Ω/km	.250 6.35	24 AWG Stranded Tinned Copper	78*	66%	19.7	64.6	34.8	114.2
------------------------------	-------------	-----------------------------	---	--	-------------	----------------	--------------	-------------	--	--	--------------	-------------------------------	-----	-----	------	------	------	-------

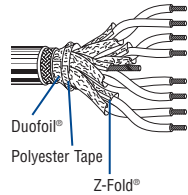

*3 Pairs

20 AWG Stranded (7x28) TC Conductors • Twisted Pairs • Overall Polyester Isolation Tape + Duofoil + TC Braid Shield (95% Coverage) • Drain Wire

Non-Plenum • Datalene® Insulation • Light Gray PVC Jacket

UL AWM Style 2919 (30V 80°C)	9901	NEC: CL2, CM CEC: CM CM	4	Gray/White, Yellow/Orange, Blue/Green, Black/Red	500 1000	152.4 304.8	53.5 106.0	24.3 48.2	20 AWG (7x28) Tinned Copper Each Pair Individually Beldfoil® Shielded 10.5Ω/M' 34.4Ω/km	Polyester Isolation Tape + Duofoil® + 95% Tinned Copper Braid 6.6Ω/km	.415 10.54	22 AWG Stranded Tinned Copper	78	78%	16.7	54.8	29.5	96.8
------------------------------	-------------	-------------------------------	---	--	-------------	----------------	---------------	--------------	--	--	---------------	-------------------------------	----	-----	------	------	------	------

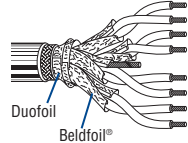

For Plenum version of 9901, see 89901.

DEC Part No. 17-01320-00

UL AWM Style 2919 (30V 80°C)	9902	NEC: CL2, CM CEC: CM CM	5	Gray/White, Yellow/Orange, Blue/Green, Red/Brown, Red/Black	500 1000	152.4 304.8	76.0 145.0	34.5 65.9	20 AWG (7x28) Tinned Copper Each Pair Individually Beldfoil® Shielded 10.5Ω/M' 34.4Ω/km	Polyester Isolation Tape + Duofoil® + 95% Tinned Copper Braid 5.4Ω/km	.495 12.58	20 AWG Stranded Tinned Copper	78	78%	16.7	54.8	29.5	96.8
------------------------------	-------------	-------------------------------	---	---	-------------	----------------	---------------	--------------	--	--	---------------	-------------------------------	----	-----	------	------	------	------

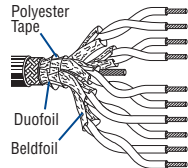

Plenum • FEP Teflon® Insulation†† • Light Gray Fluorocopolymer (PVDF) Jacket

150°C	89901	NEC: CMP CEC: CMP CMP	4	Gray/White, Yellow/Orange, Blue/Green, Red/Black	500†† 1000††	152.4 304.8	51.5 104.0	23.4 47.3	20 AWG (7x28) Tinned Copper Each Pair Individually Beldfoil® Shielded 10.5Ω/M' 34.4Ω/km	Polyester Isolation Tape + Duofoil® + 95% Tinned Copper Braid 4.9Ω/km	.370 9.40	22 AWG Stranded Tinned Copper	78	78%	16.7	54.8	29.5	96.8
-------	--------------	-----------------------------	---	--	-----------------	----------------	---------------	--------------	--	--	--------------	-------------------------------	----	-----	------	------	------	------

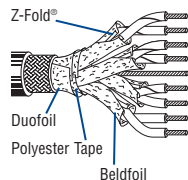

††Foam FEP (data pairs) and solid FEP (power pair).
DEC Part No. 17-01319-00 • Suitable for Outdoor and Direct Burial applications.

DCR = DC Resistance • TC = Tinned Copper

* Capacitance between conductors.

**Capacitance between one conductor and other conductors connected to shield.

†† Spools are one piece, but length may vary ±10% from length shown.

⚠ Not RoHS compliant at time of printing. Please check with Belden Technical Support for current compliance information at 1-800-BELDEN-1.

Teflon is a DuPont trademark.



For more information, contact Belden Technical Support: 1-800-BELDEN-1 • www.belden.com

IEEE 802.3 • Ethernet 10Base5

Transceiver Cables

Description	Part No.	UL NEC/ C(UL) CEC Type	No. of Pairs	Color Code	Standard Lengths		Standard Unit Wt.		Conductor (stranding) Nom. DCR	Shielding Materials Nom. DCR	Nominal OD		Drain Wire	Nom. Imp. (Ω)	Nom. Vel. of Prop.	Nominal Capacitance			
					Ft.	m	Lbs.	kg			Inch	mm				* pF/Ft.	* pF/m	** pF/Ft.	** pF/m

20 AWG Stranded (7x28) .038" TC Cond. • Twisted Pairs • Beldfoil® (100% Coverage) + Polyester Tape + TC Braid Shield (95% Cov.) • Drain Wire

Non-Plenum • Ethernet • Datalene® Insulation • Light Blue PVC Jacket

UL AWM Style 2919 (30V 80°C)	9892	NEC: CM, CL2 CEC: CM	4	Gray/White, Yellow/Orange, Blue/Green, Black/Red	500 1000	152.4 304.8	51.5 101.0	23.4 45.9	20 AWG (7x28) .038" Tinned Copper 9.5Ω/M' 31.2Ω/km	Polyester Isolation Tape + 95% Tinned Copper Braid 1.9Ω/M' 6.2Ω/km	.398 10.1	22 AWG (7x30) Tinned Copper	78 78%	16.7	54.8	29.5	96.8
------------------------------	-------------	-------------------------	---	--	-------------	----------------	---------------	--------------	--	--	--------------	-----------------------------------	-----------	------	------	------	------

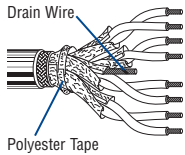

20 AWG Stranded (7x28) .038" TC Conductors • Twisted Pairs • Beldfoil® Inner + Overall Duofoil® (100% Coverage) + TC Braid Shield (95% Cov.)

Plenum • Ethernet • Foam FEP Insulation (Data) • Solid FEP Insulation (Power) • Brown Fluorocopolymer Jacket

UL AWM Style 2919 (30V 80°C)	89892	NEC: CMP CEC: CMP	4	Gray/White, Yellow/Orange, Blue/Green, Red/Black	500 1000	152.4 304.8	50.0 101.0	22.7 45.9	20 AWG (7x28) .038" Tinned Copper 9.5Ω/M' 31.2Ω/km	Polyester Isolation Tape + Duofoil® + 95% Tinned Copper Braid 1.5Ω/M' 4.9Ω/km	.359 9.1	22 AWG (7x30) Tinned Copper	78 78%	16.7	54.8	29.5	96.8
------------------------------	--------------	----------------------	---	--	-------------	----------------	---------------	--------------	--	---	-------------	-----------------------------------	-----------	------	------	------	------

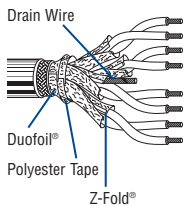

20 and 22 AWG Stranded TC Conductors • Twisted Pairs • Beldfoil® Inner Shield (100% Coverage) + Overall TC Braid Shield (95% Coverage)

Non-Plenum • Ethernet • Foam HDPE (22 AWG) and PVC (20 AWG) Insulation • Light Blue PVC Jacket

UL AWM Style 2919 (30V 80°C)	9891	NEC: CM CEC: CM	4	Black/White, Yellow/Orange, Blue/Green, Gray/Purple	100 500 1000	30.4 152.4 304.8	7.4 36.0 70.0	3.7 16.3 16.3	3 Pair: (7x28) 22 AWG (7x30) 14.7Ω/M' 48.23Ω/km Foam HDPE Insulation 1 Pair: 20 AWG (7x28) TC 9.5Ω/M' 31.1Ω/km PVC Insulation	Each Pair Individually Shielded, Overall Duofoil + 95% Tinned Copper Braid Beldfoil® TC 1.8Ω/M' 5.9Ω/km	.316 8.0	22 AWG (7x30) Tinned Copper	78* 78%*	16.7*	54.8*	29.5*	96.8*
------------------------------	-------------	--------------------	---	---	--------------------	------------------------	---------------------	---------------------	--	--	-------------	-----------------------------------	-------------	-------	-------	-------	-------

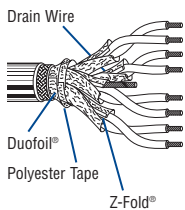

*3 Pairs

DCR = DC Resistance • HDPE = High-density Polyethylene • TC = Tinned Copper



* Capacitance between conductors.

**Capacitance between one conductor and other conductors connected to shield.

⚠ Not RoHS compliant at time of printing. Please check with Belden Technical Support for current compliance information at 1-800-BELDEN-1.

IEEE 802.4 MAP & Mini-MAP • IEEE 802.7

Broadband Coaxial Cables

Description	Part No.	UL NEC/ C(UL) CEC Type	Standard Lengths		Standard Unit Weight		Conductor (stranding) Diameter Nom. DCR	Nominal Core OD		Shielding Materials Nom. DCR	Nominal OD		Nom. Imp. (Ω)	Nom. Vel. of Prop.	Nominal Capacitance		Nominal Attenuation			
			Ft.	m	Lbs.	kg		Inch	mm		Inch	mm			pF/Ft.	pF/m	MHz	dB/ 100 Ft.	dB/ 100m	
RG-6/U Type • 18 AWG Solid Bare Copper-covered Steel Conductor • Duobond® IV* Quad Shield (100% Coverage)																				
Non-Plenum • Gas-injected Foam Polyethylene Insulation • Gray PVC Jacket																				
	3131A	NEC:	1000 **	304.8	41.0	18.6	18 AWG	.180	4.57	Duobond IV	.300	7.62	75	82%	16.2	53.1	1	.35	1.2	
		CL2R,	2500 †	762.2	102.5	46.5	(solid)			Quad Shield								2	.38	1.3
		CMR					.040"			3.6Ω/M'								5	.45	1.5
		CEC:					BCCS			11.8Ω/km								10	.59	1.9
		CMG					28.0Ω/M'											20	.86	2.8
							91.8Ω/km											50	1.37	4.5
																		100	1.97	6.5
																		200	2.82	9.3
																		300	3.48	11.4
																		400	4.04	13.3
Tap marks every 2.6 meters to aid users in installation.																				
Plenum • Foam FEP Insulation • Gray Fluorocopolymer Jacket																				
	3132A	NEC:	1000 **	304.8	36.0	16.4	18 AWG	.170	4.32	Duobond IV	.274	6.96	75	82%	16.3	53.5	1	.36	1.2	
		CMP					(solid)			Quad Shield								2	.38	1.3
		CEC:					.040"			3.6Ω/M'								5	.50	1.6
		CMP					BCCS			11.8Ω/km								10	.65	2.1
							28.0Ω/M'											20	.95	3.1
							91.8Ω/km											50	1.50	4.9
																		100	2.12	7.0
																		200	2.99	9.8
																		300	3.66	12.0
																		400	4.23	13.9
Tap marks every 2.6 meters to aid users in installation. Suitable for Outdoor and Direct Burial applications.																				

BCCS = Bare Copper Covered Steel • DCR = DC Resistance

*Duobond IV Quad Shield = Duobond + 60% aluminum braid + Duofoil® + 40% aluminum braid.

†Spools are one piece, but length may vary ±10% from length shown.

**1000' exact 1 pc.

 Not RoHS compliant at time of printing. Please check with Belden Technical Support for current compliance information at 1-800-BELDEN-1.

IEEE 802.4 MAP & Mini-MAP • IEEE 802.7

Broadband Coaxial Cables

Description	Part No.	UL NEC/ C(UL) CEC Type	Standard Lengths		Standard Unit Weight		Conductor (stranding) Diameter Nom. DCR	Nominal Core OD		Shielding Materials Nom. DCR	Nominal OD		Nom. Imp. (Ω)	Nom. Vel. of Prop.	Nominal Capacitance		Nominal Attenuation		
			Ft.	m	Lbs.	kg		Inch	mm		Inch	mm			pF/Ft.	pF/m	MHz	dB/100 Ft.	dB/100m
RG-11/U Type • 14 AWG Solid Bare Copper-covered Steel Conductor • Duobond IV* Quad Shield (100% Coverage)																			
Non-Plenum • Gas-injected Foam Polyethylene Insulation • Gray PVC Jacket																			
	3094A	NEC:	500 **	152.4	31.0	14.1	14 AWG	.280	7.11	Duobond IV	.407	10.34	75	82%	16.2	53.1	1	.16	.5
		CL2R,	1000 **	304.8	62.0	28.2	(solid)			Quad Shield							2	.18	.6
		CMR,	2000 †	609.6	122.0	55.3	.064"			1.5Ω/M'							5	.26	.9
		CEC:					BCCS			4.9Ω/km							10	.38	1.2
		CMG					11.0Ω/M'										20	.55	1.8
							36.1Ω/km										50	.83	2.7
																	100	1.17	3.8
																	200	1.60	5.3
																	300	1.99	6.6
																	400	2.30	7.6
Tap marks every 2.6 meters to aid users in installation.																			
Plenum • Foam FEP Insulation • Gray Fluorocopolymer Jacket																			
150°C	3095A	NEC:	1000 **	304.8	76.0	34.5	14 AWG	.280	7.11	Duobond IV	.387	9.83	75	82%	16.5	54.1	1	.17	.6
		CMP					(solid)			Quad Shield							2	.22	.7
		CEC:					.064"			3.9Ω/M'							5	.28	.9
		CMP					BCCS			12.8Ω/km							10	.40	1.3
							11.0Ω/M'										20	.60	2.0
							36.1Ω/km										50	1.20	3.9
																	100	1.70	5.6
																	200	2.50	8.2
																	300	3.04	10.0
																	400	3.50	11.5
Tap marks every 2.6 meters to aid users in installation.																			
Suitable for Outdoor and Direct Burial applications.																			

BCCS = Bare Copper Covered Steel • DCR = DC Resistance

*Duobond IV Quad Shield = Duobond + 60% aluminum braid + Duofoil® + 40% aluminum braid.

†Spools are one piece, but length may vary ±10% from length shown.

**500' & 1000' exact 1 pc.

 Not RoHS compliant at time of printing. Please check with Belden Technical Support for current compliance information at 1-800-BELDEN-1.

IEEE 802.5; ISO/IEC 8802.5

IBM Cabling System

Types 1A and 1

Description	Part No.	UL NEC/ C(UL) CEC Type	No. of Pairs	Standard Lengths		Standard Unit Wt.		Nominal OD		AWG (stranding) Diameter Nom. DCR	Shielding	Nom. Imped. (Ω)	Nominal Capacitance		Freq. (MHz)	Maximum Attenuation		Min. NEXT	
				Ft.	m	Lbs.	kg	Inch	mm				* pF/Ft.	* pF/m		(dB/ 1000')	(dB/ 100m)	(dB/ 3280')	(dB/ 1000m)

IBM Type 1A • 22 AWG Solid BC Conductors • Each Pair Individually Beldfoil® Shielded + Overall TC Braid Shield (65% Coverage) • Rip Cord

Non-Plenum • Flame-retardant Foam Polyethylene Insulation • Black PVC Jacket

IBM Part No. 9688	NEC:	2	500 [†]	152.4	26.5	12.0	.296	7.52	22	100%	150	8.5	27.9	4	6.7	2.2	58.0	58.0
4716748	CMG:		1000 [†]	304.8	50.0	22.7	x	x	(solid)	Beldfoil				16	13.4	4.4	50.4	50.4
33G2772	CEC:		2000 [†]	609.8	102.0	46.3	.431	10.95	BC	Each Pair				100	37.5	12.3	38.5	38.5
	CMG:		3600 [†]	1097.6	190.8	86.5			.026"	+ 65%				300	65.2	21.4	31.3	31.3
									16.7Ω/M'	TC Braid				100 ^{††}	40.8	13.4	—	—
									54.7Ω/km	Overall				300 ^{††}	71.0	23.3	—	—
														600 ^{††}	100.3	32.9	—	—

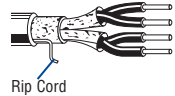

Rip Cord

Meets IEEE 802.5 and TIA/EIA-568-A specifications, ETL verified. For Token Ring (4/16 Mbps), FDDI over copper, and video applications. IBM qualified Type 1A Media cable for use in IBM Cabling Systems. For Non-suffix "A" Type IBM Product, see 1634A below.

Plenum • Foam FEP Teflon® Insulation • Black Flamarrest® Jacket

IBM Part No. 82688	NEC:	2	1000 [†]	304.8	47.0	21.4	.248	6.30	22	100%	150	8.5	27.9	4	6.7	2.2	58.0	58.0
4716749	CMP:						x	x	(solid)	Beldfoil				16	13.4	4.4	50.4	50.4
33G8220	CEC:						.348	8.84	BC	Each Pair				100	37.5	12.3	38.5	38.5
	CMP:								.026"	+ 65%				300	65.2	21.4	31.3	31.3
									16.7Ω/M'	TC Braid				100 ^{††}	40.8	13.4	—	—
									54.7Ω/km	Overall				300 ^{††}	71.0	23.3	—	—
														600 ^{††}	100.3	32.9	—	—

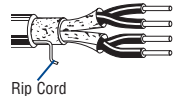

Rip Cord

Meets IEEE 802.5 and TIA/EIA-568-A specifications, ETL verified. IBM qualified Type 1A Media cable for use in IBM Cabling Systems. For Token Ring (4/16 Mbps), FDDI over copper, and video applications.

IBM Type 1 • 22 AWG Solid BC Conductors • Each Pair Individually Beldfoil Shielded + Overall TC Braid Shield (65% Coverage) • Rip Cord

Non-Plenum • Flame-retardant Foam Polyethylene Insulation • Black PVC Jacket

IBM Part No. 1634A	NEC:	2	1000 [†]	304.8	50.0	22.7	.296	7.52	22	100%	150	8.5	27.9	4	6.7	2.2	58.0	58.0
4716748	CMG:		2000 [†]	609.8	102.0	46.4	x	x	(solid)	Beldfoil				16	13.4	4.4	40.0	40.0
	CEC:		3600 [†]	1097.6	190.8	86.7	.431	10.95	BC	Each Pair								
	CMG:								.026"	+ 65%								
									17.4Ω/M'	TC Braid								
									57.1Ω/km	Overall								

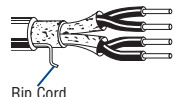

Rip Cord

Meets IEEE 802.5 and TIA/EIA-568-A specifications, ETL verified. For Token Ring (4/16 Mbps), FDDI over copper, and video applications. IBM qualified Type 1 Media cable for use in IBM Cabling Systems. For Suffix A counterpart see 9688 above.

DCR = DC Resistance • BC = Bare Copper • NEXT = Near-end Crosstalk • TC = Tinned Copper

* Capacitance between conductors

† Spools are one piece, but length may vary ±10% from length shown.

†† Common mode

⚠ Not RoHS compliant at time of printing. Please check with Belden Technical Support for current compliance information at 1-800-BELDEN-1.

Teflon is a DuPont trademark.



For more information, contact Belden Technical Support: 1-800-BELDEN-1 • www.belden.com

IEEE 802.5; ISO/IEC 8802.5

IBM Cabling System

Types 2A and 6A

Description	Part No.	UL NEC/ C(UL) CEC Type	No. of Pairs	Standard Lengths		Standard Unit Wt.		Nominal OD		AWG (stranding) Diameter Nom. DCR	Shielding	Nom. Imped. (Ω)	Nominal Capacitance		Freq. (MHz)	Maximum Attenuation		Min. NEXT	
				Ft.	m	Lbs.	kg	Inch	mm				* pF/Ft.	* pF/m		(dB/ 1000')	(dB/ 100m)	(dB/ 3280')	(dB/ 1000m)

IBM Type 2A • 22 AWG Solid Bare Copper Conductors • Each Pair Individually Beldfoil® Shielded + Overall TC Braid Shield (65% Coverage)

Non-Plenum • Flame-retardant Foam Polyethylene Insulation • Black PVC Jacket

IBM Part No. 9689	NEC: 6*	1000 [†]	304.8	80.0	36.4	.324	8.23	22	100%	150	8.5	27.9	1k**	.390	.128	—	—
4716739	CMG	3600 [†]	1097.6	298.8	135.8	x	x	(solid)	Beldfoil	@ 1MHz	(data)	(data)	4	6.7	2.2	58.0	58.0
33G2773	CEC: CMG					.466	11.84	BC	Each Pair	(data)			16	13.4	4.4	50.4	50.4
								.026"	+ 65%	600			100	37.5	12.3	38.5	38.5
								16.7Ω/M'	TC Braid	@ 1kHz			300	65.2	21.4	31.3	31.3
								54.7Ω/km	Overall	(voice)			100 ^{††}	40.8	13.4	—	—
									(data only)				300 ^{††}	71.0	23.3	—	—
													600 ^{††}	100.3	32.9	—	—

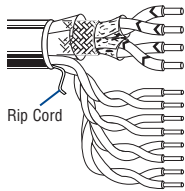

For Plenum version of 9689, see 82689.

IBM qualified Type 2A Media cable for use in IBM Cabling Systems.

Plenum • Foam FEP Teflon® Insulation • Black Flamarrest® Jacket

IBM Part No. 82689	NEC: 6*	1000 [†]	304.8	79.0	35.9	.324	8.23	22	100%	150	8.5	27.9	1k**	.390	.128	—	—
4716738	CMP					x	x	(solid)	Beldfoil	@ 1MHz	(data)	(data)	4	6.7	2.2	58.0	58.0
33G8221	CEC: CMP					.460	11.68	BC	Each Pair	(data)			16	13.4	4.4	50.4	50.4
								.026"	+ 65%	600			100	37.5	12.3	38.5	38.5
								16.7Ω/M'	TC Braid	@ 1kHz			300	65.2	21.4	31.3	31.3
								54.7Ω/km	Overall	(voice)			100 ^{††}	40.8	13.4	—	—
									(data only)				300 ^{††}	71.0	23.3	—	—
													600 ^{††}	100.3	32.9	—	—

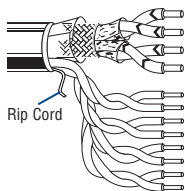

IBM qualified Type 2A Media cable for use in IBM Cabling Systems.

IBM Type 6A • 26 AWG Stranded (7x34) BC Conductors • Twisted Pairs • Beldfoil Shielded Pairs + Overall TC Braid Shield (65% Coverage)

Non-Plenum • Datalene® Insulation • Striated Black PVC Jacket

IBM Part No. 1215A	NEC: 2	1000 [†]	304.8	46.0	20.9	.325	8.26	26	100%	150	8.5	27.9	4	10	3.3	52.0	52.0
4716743	CL2, CM							(7x34)	Beldfoil				16	20	6.6	44.0	44.0
33G2775	CEC: CM							BC	Each Pair				100	57	18.7	33.0	33.0
								.019"	+ 65%				300	100	32.3	25.0	25.0
								38.7Ω/M'	TC Braid								
								127.0Ω/km	Overall								



IBM qualified Type 6A Office cable for use in IBM Cabling Systems.

BC = Bare Copper • DCR = DC Resistance • NEXT = Near-end Crosstalk • TC = Tinned Copper

* Capacitance between conductors

**Voice pairs (1 kHz); Data pairs (4–600 MHz)

† Spools are one piece, but length may vary ±10% from length shown.

†† Common mode

▲ (2) shielded Data-grade pairs; (4) unshielded Voice-grade media pairs

⚠ Not RoHS compliant at time of printing. Please check with Belden Technical Support for current compliance information at 1-800-BELDEN-1.

Teflon is a DuPont trademark.



For more information, contact Belden Technical Support: 1-800-BELDEN-1 • www.belden.com

IBM RISC System/6000

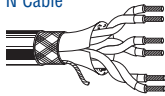
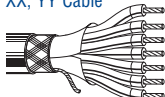
Description	Part No.	UL NEC/ C(UL) CEC Type	No. of Pairs/ Cond.	Standard Lengths		Standard Unit Wt.		Nominal OD		AWG (stranding) Material Nom. DCR	Shielding Material Nom. DCR	Nom. Imped. (Ω)	Nominal Capacitance			
				Ft.	m	Lbs.	kg	Inch	mm				* pF/Ft.	* pF/m	** pF/Ft.	** pF/m
28 AWG Stranded (7x36) Bare Copper Conductors • Twisted Pairs • Overall Beldfoil® Shielded + TC Braid Shield (65% Coverage) • TC Drain Wire																
Non-Plenum • Patented Step Polyolefin Insulation • Gray PVC Jacket (See RISC Color Code Chart below)																
IBM Part No. N Cable	1538A	NEC: CL2	3	U-1000 1000	U-304.8 304.8	24.0 25.0	10.9 11.4	.225	5.72	28 (7x36) Bare Copper 63.0Ω/M' 207.0Ω/km	Overall Beldfoil + 65% TC Braid 5.5Ω/M' 18.0Ω/km	120	12.0	39.4	21.5	70.5
																
RJ-45 compatible																
IBM Part No. XX, YY Cable	1540A	NEC: CL2	7/c	U-1000 1000	U-304.8 304.8	21.0 21.0	9.5 9.5	.190	4.83	28 (7x36) Bare Copper 63.0Ω/M' 207.0Ω/km	Overall Beldfoil + 65% TC Braid 7.2Ω/M' 23.6Ω/km	—	12.5	41.0	23.0	75.5
																
RJ-45 compatible																

DC = DC Resistance • TC = Tinned Copper

* Capacitance between conductors

** Capacitance between one conductor and other conductors connected to shield

Color Codes: IBM RISC System/6000

Cond.	Color	Pair No.	Color Combination
1st	White over Blue	1	White over Blue & Blue over White
2nd	White over Orange	2	White over Orange & Orange over White
3rd	White over Green	3	White over Green & Green over White
4th	White over Brown		
5th	White over Gray		
6th	White over Red		
7th	White over Yellow		

SCSI 25- and 34-Pair Cable

(Small Computer System Interface)

Description	Part No.	UL NEC/ C(UL) CEC Type	No. of Pairs	Standard Lengths		Standard Unit Weight		Nominal OD		AWG (stranding) Material Nom. DCR	Shielding Material Nom. DCR	Nom. Imped. (Ω)	Nom. Vel. of Prop.	Nominal Capacitance			
				Ft.	m	Lbs.	kg	Inch	mm					* pF/Ft.	* pF/m	** pF/Ft.	** pF/m

SCSI • 28 AWG Stranded (7x36) TC Conductors • Twisted Pairs • Overall Beldfoil® Shield + TC Braid Shield (85% Coverage) • See Color Code Chart (below)

Non-Plenum • Flame-retardant Polyolefin Insulation • Polypropylene Buffer Layer • Light Gray PVC Jacket

150V	1401A	NEC: CL2, CMG CEC: CMG	25	500 1000	152.4 304.8	51.5 101.0	23.4 45.9	.420	10.7	28 (7x36) TC 64.9Ω/M' 212.9Ω/km	Overall Beldfoil + 85% TC Braid 2.0Ω/M' 6.6Ω/km	120† 80††	66%	12.7	41.7	30.0	98.4
150V	1403A	NEC: CL2, CM CEC: CM	34	500 1000	152.4 304.8	71.5 139.0	32.5 63.2	.480	12.2	28 (7x36) TC 64.9Ω/M' 212.2Ω/km	Overall Beldfoil + 85% TC Braid 1.5Ω/M' 4.9Ω/km	120† 80††	66%	12.7	41.7	30.0	98.4

DCR = DC Resistance • TC = Tinned Copper

* Capacitance between conductors.

** Capacitance between one conductor and other conductors connected to shield.

† Differential mode impedance.

†† Single end mode termination impedance.

Color Codes: Modified Western Electric Standard

Pair No.	Color Combination	Pair No.	Color Combination	Pair No.	Color Combination	Pair No.	Color Combination
1	White/Blue Stripe & Blue/White Stripe	9	Red/Brown Stripe & Brown/Red Stripe	17	Yellow/Orange Stripe & Orange/Yellow Stripe	25	Purple/Gray Stripe & Gray/Purple Stripe
2	White/Orange Stripe & Orange/White Stripe	10	Red/Gray Stripe & Gray/Red Stripe	18	Yellow/Green Stripe & Green/Yellow Stripe	26	White & Blue
3	White/Green Stripe & Green/White Stripe	11	Black/Blue Stripe & Blue/Black Stripe	19	Yellow/Brown Stripe & Brown/Yellow Stripe	27	White & Orange
4	White/Brown Stripe & Brown/White Stripe	12	Black/Orange Stripe & Orange/Black Stripe	20	Yellow/Gray Stripe & Gray/Yellow Stripe	28	White & Green
5	White/Gray Stripe & Gray/White Stripe	13	Black/Green Stripe & Green/Black Stripe	21	Purple/Blue Stripe & Blue/Purple Stripe	29	White & Brown
6	Red/Blue Stripe & Blue/Red Stripe	14	Black/Brown Stripe & Brown/Black Stripe	22	Purple/Orange Stripe & Orange/Purple Stripe	30	White & Gray
7	Red/Orange Stripe & Orange/Red Stripe	15	Black/Gray Stripe & Gray/Black Stripe	23	Purple/Green Stripe & Green/Purple Stripe	31	Red & Blue
8	Red/Green Stripe & Green/Red Stripe	16	Yellow/Blue Stripe & Blue/Yellow Stripe	24	Purple/Brown Stripe & Brown/Purple Stripe	32	Red & Orange
						33	Red & Green
						34	Red & Brown





Commercial Networking: Optical Fiber

16

Table of Contents

Commercial Networking — Optical Fiber		Page No.
Introduction		16.2
Optical Fiber Connectivity Products		16.4–16.17
FiberExpress Connectors		16.4
Pre-Connectorized Assemblies		16.6
FiberExpress Secure/Keyed LC System		16.9
FiberExpress Manager		16.11
FiberExpress Patch Panels		16.12
FiberExpress Patch Panels Accessories		16.14
FiberExpress Outlets		16.15
Network Connectivity Products		16.17
Optical Fiber Cables		16.18–16.34
Fiber Cable Selection Guide		16.18
Interconnect Cable — Simplex & Duplex		16.19
Distribution Cable		16.20
Breakout Style Cable		16.22
Industrial Armored Cable		16.24
Tactical Cable		16.25
Ribbon Cable		16.26
Single Jacket, All Dielectric Cable		16.27
Double Jacket, Armored Cable		16.29
Double Jacket, Heavy-Duty Cable		16.30
Central Tube Cable		16.31
Micro Loose Tube Breakout Style Cable		16.33
TrayOptic® Heavy-Duty, All Dielectric Cable		16.34

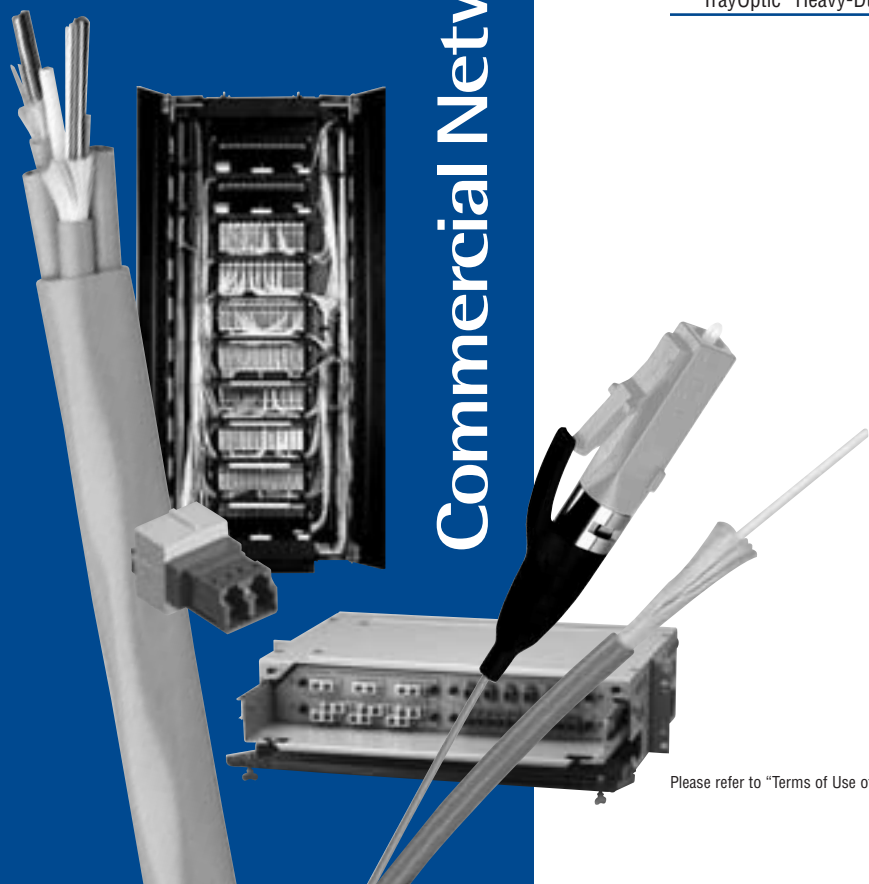

Introduction

Belden IBDN FiberExpress Systems

Optical fiber systems offer many benefits: high bandwidth and transmission speed, the potential for network growth, extended reach, fault tolerance, greater data security and support for Gigabit and multi-Gigabit protocols and networked applications. Beyond these traditional benefits, however, Belden offers the *FiberExpress* Solution, a complete end-to-end cabling system supporting both centralized and fiber-to-the-desk topologies, as well as backbone and campus cabling configurations. Our *FiberExpress* Solutions meet or exceed all applicable TIA/EIA, ISO/IEC and IEEE standards and offer:

- Reduced design complexities
- Greater deployment facility
- Quick installation
- Increased flexibility
- Cost effective pricing

Primary *FiberExpress* System Components

Key components of the *FiberExpress* Systems are summarized below and are found on the catalog pages that follow.

Optimax® Connectors

Optimax Connectors are a revolutionary field-installable optical fiber connector. The unique design of the patented mechanical splice body of Optimax incorporates a factory mounted fiber stub and a pre-polished ceramic ferrule. This technology consistently provides a fast, secure and reliable LC, SC or ST Compatible optical fiber termination for multimode or single-mode cable. All critical steps are performed in the factory, ensuring a superior quality connection every time.



The *FiberExpress* Manager

The *FiberExpress* Manager makes fiber management easier than ever before. Designed to streamline termination, connection and maintenance activities, the *FiberExpress* Manager uses a scalable, modular approach to adapt to a wide variety of situations. The total system provides extra high connection density while facilitating cable routing and patch cord management. The *FiberExpress* Manager is adaptable for almost all situations, traditional field termination or pre-terminated modules, which reduces design complexity and increases deployment efficiency.



Extended Reach Optical Fiber Cables

Extended Reach Optical Fiber Cables propel your network into the future of cable technology with our multimode *FiberExpress* FX300, FX600 or FX2000 series. These series were developed to meet the existing needs of networks at 1 Gb/s (Ethernet, 1000Base-SX and 1000Base-LX) and new networks at 10 Gb/s (Ethernet, 10GBase-S and 10GBase-LX4). These series offer better reach for laser-based systems. For 1 Gb/s Ethernet at 850 nm (VCSEL), the FX300 and FX600 series provide a range of 984 ft (300 m) and 1,968 ft (600 m), respectively. For 10 Gb/s Ethernet at 850 nm (VCSEL), the FX2000 series provide a range of 984 ft (300 m) for 10GBase-S where all of multimode series can offer a 984 ft (300 m) range at 1300 nm (laser) for 10GBase-LX4. All of this while assuring total compatibility with LED systems and FDDI fiber installation cables. Our single-mode cable offering enhances the options for longer distance support — up to 40 km — for any of the Gigabit Ethernet applications.



The *FiberExpress* Bar

The *FiberExpress* Bar is an extremely compact, modular and resilient linking panel. Resembling a power bar, it offers 6 or 12 fibers, pre-terminated with an SC, SC duplex, ST-compatible, LC, MT-RJ or FC connectors



and a cord terminated with a multi-fiber MPO connector — all of which are factory verified. The *FiberExpress* Bar can adapt to all kinds of properties or developments, and can serve as a consolidation or linking point. It's available in both single-mode and multimode media.

For the ultimate in quick, easy and reliable optical networking we also offer the *FiberExpress* Pre-connectorized System. Based on the concept of building blocks, the complete range of pre-terminated *FiberExpress* components bring flexibility to the design stage. The in-factory fabrication and verification of pre-terminated connections ensures the high-performance and high-quality of the product. These products are "plug and go" and their deployment requires no specialized tools — you can deploy 12 fibers in the same amount of time it takes to connect a power cord to a standard electrical plug. This pre-terminated technology will help to preserve the initial investment by its ability to be re-deployed while always ensuring quality results.

Quality Installation and Service

All Belden IBDN systems are designed, installed and field-tested by fully-trained and certified system contractors and integrators to further assure superior systems performance. They are also backed by a strict System Certification and Warranty Program.

System Certification and Warranty Program

The Belden IBDN Certification Program is a rigorous process that ensures that your Belden IBDN 'Certified' System is composed of Belden IBDN components, designed and installed by a factory-trained Certified System Vendor. Belden IBDN 'Certified' Systems are supported by a series of warranties that surpass conventional product warranties. Certification adds important end-to-end system performance guarantees and ensures full compliance with cabling industry standard specifications — even after system installation (Installable Performance®). A 25-year Product Warranty and a Lifetime Application Assurance program accompany each Belden IBDN 'Certified' System installation. These warranty programs include coverage for both parts and labor.

Fiber Channel Topology

FiberExpress® System Matrix	Page No.	Fiber-to-the-Desk (FTTD) and Centralized Fiber	Fiber Backbone (In-Building)	Fiber Backbone (Campus)	FiberExpress Pre-Terminated Solutions*
FiberExpress Cables					
Distribution & Breakout Cable Series Multimode and Single-mode	16.20– 16.23	●			●
Interconnect Cable Series Multimode and Single-mode	16.19	●			
Loose Tube (Campus) Cable Series MM, SM, Composite MM/SM	16.27– 16.34			●	●
Ribbon Cable Series Multimode and Single-mode	16.26	●	●	●	●
Cross-Connect Hardware in the Telecom Room					
FiberExpress Manager with FiberExpress Manager Connector Modules Multimode and Single-mode	16.11	●	●	●	●
FiberExpress Rack Mount Patch Panel with Universal Adapter Strips Multimode and Single-mode	16.12	●		●	●
FiberExpress Wall Mount Patch Panel with Universal Adapter Strips Multimode and Single-mode	16.13	●		●	●
FiberExpress Bar: Multimode and Single-mode	16.8	●	●	●	●
Patch Cords in the Telecom Room and at the Work Area					
FiberExpress Patch Cords: Multimode and Single-mode	16.6	●	●	●	●
Outlets at the Work Area					
MDVO® Multimedia Outlets with MDVO Multimedia Modules	16.16	●			
MediaFlex® Outlets with MediaFlex Multimedia Inserts	16.15	●			
FiberExpress Bar Multimode and Single-mode (as MUTOA)	16.8	●	●		
Fiber Connectivity					
Optimax® Connectors Multimode and Single-mode	16.4	●		●	●
Epoxy Field Mountable Connectors Multimode and Single-mode	16.5	●		●	●
Fiber Pigtails Multimode and Single-mode	16.8	●		●	●

MM = Multimode • SM = Single-mode

*FiberExpress Pre-terminated Solutions provide simple-to-install, high-performance fiber channels through custom length, high precision factory terminated cables and matching optical connectivity components.

FiberExpress Connectors

Optimax® Field Installable Connectors and Installation Tool Kits

AX101982 Optimax LC Connector



AX100029 with AX101794 Optimax SC Connector



A0408835 with AX101793 Optimax ST Compatible Connector



AX100947 Optimax Tool Kit



Optimax Field Installable Connector

The **Optimax Connectors** are reliable field installable optical fiber connectors that are easy to install. They do not require epoxy, curing or polishing. Their unique design incorporates a factory polished fiber stub in a splice mechanism which provides a fast, secure, and reliable termination on optical fiber cables. All critical steps are performed in the factory, ensuring a superior-quality connection every time. Only simple tools are required for installation, making Optimax a cost effective field termination.

Optimax Connectors are high-quality LC, SC and ST Compatible connectors that use a ceramic ferrule with a physical contact (PC) polish for Multimode and super physical contact (SPC) polish for Single-mode that ensures the best possible mating of optical fibers. Connectors are available for 62.5 or 50/125 μ m Multimode fiber and Single-mode fiber installations.

Optimax Installation Tool Kit

The **Optimax Installation Tool Kit** is packaged in a small convenient carrying case and includes an Optimax LC, SC and ST Compatible installation and training video, installation instructions and all the tools required to terminate 900 μ m buffered optical fiber and jacketed optical fiber.

The Optimax Installation Tool Kit has all the tools and supplies required to install both the Optimax LC, SC or ST Compatible Multimode and Single-mode connectors. Certain tool kit items can be purchased separately to accommodate installers already possessing basic optical fiber installation tools.

Description	Belden Part Number
-------------	--------------------

FiberExpress Connectors

Optimax Field Installable Connector	
LC 62.5 μ m, Multimode*	AX101981
LC 50 μ m, Multimode*	AX101982
LC Single-mode*	AX101983
SC 62.5 μ m, Multimode*	AX100029
SC 50 μ m, Multimode*	AX101077
SC Single-mode*	AX101792
ST Compatible 62.5 μ m, Multimode*	A0408835
ST Compatible 50 μ m, Multimode*	AX101075
ST Compatible Single-mode*	AX101791
LC Accessory Kit for jacketed fiber (2 mm boot and a crimp sleeve)	AX101984
SC Accessory Kit for jacketed fiber (3 mm boot, crimp sleeves, cord adapter)	AX101794
ST Accessory Kit for jacketed fiber (3 mm boot, crimp sleeves)	AX101793

Optimax Installation Tool Kit	
LC/SC/ST Compatible (includes installation tools, fiber cleaver, crimping tool, instruction manual, microscope, tweezers, alcohol wipes, marker, scissors, waste bottle, fiber stripper, cable stripper and Training Video)	AX100947
Basic (excludes fiber stripper & cleaver)	AX100949
Optimax LC Tool Kit Upgrade (includes LC installation tool, instructions manual, foam for the case)	AX102061

Optimax Individual Components	
Fiber Cleaver	A0408829
Installation Tool LC (does not include tool-clamp)	AX102062
Installation Tools ST Compatible and SC (includes tool-clamp)	A0403634
Microscope	AX100910
Refurbishing Materials (80 alcohol wipes and a black felt tip marker)	AX100951
Installation Instruction Manual, LC	AX102063
Installation Instruction Manual, SC	PX101318
Installation Instruction Manual, ST Compatible	PX101317
Installation & Training Video, CD (see literature ordering form on the web)	NOT0651
Crimp Tool complete with die	A0403641

These products are in the process of being assessed for RoHS compliance. Please check our Web Site for the most current RoHS status.

*For 900 μ m buffered fiber only. For Optimax Single-mode termination on jacketed fiber, please use the appropriate Accessory Kit.

FiberExpress Connectors

Epoxy Field Installable Connectors

A0390851 Optical Fiber Field Installable Epoxy Connector, ST Compatible



Epoxy Field Installable Connector

Epoxy Field Installable Connectors are available as Multimode and Single-mode ST Compatible and SC field installable connectors. They require heat-cured epoxy and polishing.

Both types have a ceramic ferrule. Each connector comes complete with all the parts necessary for termination of tight buffered fibers as well as jacketed fibers. Parts include crimp sleeves, boots, cord adapter and dust cap.

Description	Belden Part Number	
	Multimode	Single-mode

FiberExpress Connectors

Epoxy Field Installable Connector		
ST Compatible	A0390851	AX101412
SC Simplex	AX100919	AX101411
SC Duplex	AX100929	

These products are in the process of being assessed for RoHS compliance. Please check our Web Site for the most current RoHS status.

Pre-Connectorized Assemblies

FiberExpress Patch Cords

AX200057 Patch Cord Multimode SC Duplex (568SC)



FiberExpress Patch Cords

FiberExpress Duplex Patch Cord Assemblies are of the highest quality available. They are assembled and 100% optically tested in our factory prior to shipment. All patch cords are built with high-quality connectors and cables which guarantees superior performance and excellent reliability.

Description	Belden Part Number			
	Multimode, FX300, 62.5 μm	Multimode, FX600, 50 μm	Multimode, FX2000, 50 μm	Single-mode SPC

FiberExpress Pre-Connectorized Assemblies

Duplex Patch Cord				
ST-ST, 2 m (6 ft.)	70102419	AX200341	AX200799	AX200090
ST-ST, 3 m (10 ft.)	70102420	AX200459	AX200795	AX200091
ST-ST, 5 m (16 ft.)	70102447	AX200413	AX200800	AX200092
568SC-568SC, 2 m (6 ft.)	AX200056	AX200084	AX200603	AX200094
568SC-568SC, 3 m (10 ft.)	AX200057	AX200082	AX200589	AX200095
568SC-568SC, 5 m (16 ft.)	AX200058	AX200280	AX200624	AX200096
LC duplex-LC duplex, 2 m (6 ft.)	AX200517	AX200527	AX200664	AX200507
LC duplex-LC duplex, 3 m (10 ft.)	AX200518	AX200528	AX200665	AX200508
LC duplex-LC duplex, 5 m (16 ft.)	AX200519	AX200529	AX200666	AX200509
MTRJ-MTRJ, 2 m (6 ft.)	AX101122	AX101139	AX200801	AX101157
MTRJ-MTRJ, 3 m (10 ft.)	AX101123	AX101138	AX200802	AX101156
MTRJ-MTRJ, 5 m (16 ft.)	AX101125	AX101137	AX200803	AX101155
Hybrid Patch Cord				
568SC-ST, 3 m (10 ft.)	AX200060	AX200196	AX200900	AX200421
LC duplex-ST, 3 m (10 ft.)	AX200699	AX200695	AX200809	AX200698
LC duplex-568SC, 3 m (10 ft.)	AX200580	AX200581	AX200668	AX200667
MTRJ-ST, 3 m (10 ft.)	AX101133	AX101151	AX200810	AX101166
MTRJ-568SC, 3 m (10 ft.)	AX101128	AX101143	AX200797	AX101161
Single-ended (pigtailed)				
ST-open, 2 m (6 ft.)	70100390	AX200458	AX200811	AX200097
SC-open, 2 m (6 ft.)	70101714	AX200192	AX200653	AX200098
LC-open, 2 m (6 ft.)	AX200657	AX200658	AX200660	AX200659
MTRJ(m)-open, 3 m (10 ft.)	AX101366	AX101367	AX200812	AX101368

Also available as Simplex Patch Cords or custom assemblies, please contact Customer Service for more details.

These products are in the process of being assessed for RoHS compliance. Please check our Web Site for the most current RoHS status.

FiberExpress Pre-Connectorized Assemblies

Cable Assemblies

AX250105 MPO Cable Assembly



Multi-fiber Cable Assembly

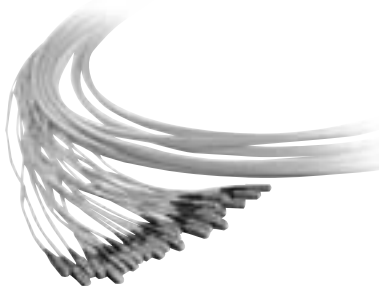

900 μm Fan-out Assembly

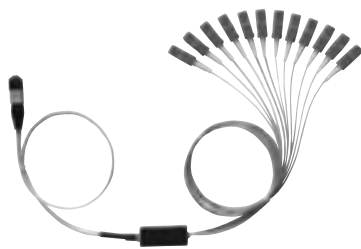

MPO Cable Assembly

MPO Cable Assemblies are multi-fiber cables using single MPO connectors 6, 8 and 12-fiber that are used to interconnect pre-terminated devices such as FiberExpress Pre-terminated Modules and FiberExpress Bars. Depending on the application, MPO Cable Assemblies can use Ribbon Cables or Loose Tube cables. MPO cables are available in lengths of up to 500 meters with a pulling-eye for ease of deployment.

Multi-fiber Cable Assembly

Multi-fiber Cable Assemblies are factory-terminated fiber cables of various constructions (distribution, breakout or ribbon) using simplex, duplex or multi-fiber connectors. They are available in configurations from 2-fiber up to 144-fiber with various kinds of fan-out constructions, lengths and geometry to suit virtually any application.

Description	Belden Part Number	
	Multimode, FX300, 62.5 μm	Multimode, FX600, 50 μm

FiberExpress Pre-Connectorized Assemblies

MPO Cable Assembly, FOMC, MPO(f)-MPO(f)		
1 pulling eye, OFNP, 12 fibers, 10 m (33 ft.)	AX250021	AX250345
1 pulling eye, OFNP, 12 fibers, 20 m (66 ft.)	AX250105	AX250376
1 pulling eye, OFNP, 12 fibers, 50 m (164 ft.)	AX250349	AX250065
1 pulling eye, OFNP, 12 fibers, 75 m (246 ft.)	AX250060	AX250066
1 pulling eye, OFNP, 12 fibers, 100 m (328 ft.)	AX250061	AX250067
		Multimode, FX2000, 50 μm
1 pulling eye, OFNP, 12 fibers, 10 m (33 ft.)	AX250457	AX250224
1 pulling eye, OFNP, 12 fibers, 20 m (66 ft.)	AX250412	AX250106
1 pulling eye, OFNP, 12 fibers, 50 m (164 ft.)	AX250387	AX250071
1 pulling eye, OFNP, 12 fibers, 75 m (246 ft.)	AX250413	AX250072
1 pulling eye, OFNP, 12 fibers, 100 m (328 ft.)	AX250458	AX250073
		Single-mode

Also available in 6 or 8-fiber MPO Cable Assemblies, please contact Customer Service for more details.

Multi-fiber Cable Assembly, MPO(m)-ST	
Multimode FX300, 62.5 μm, 12 fibers	NXC-RPML-PGPNNN-STPFBN-N-01.5
Multimode FX600, 50 μm, 12 fibers	NXC-RPNL-PGPNNN-STPFBN-N-01.5
Multimode FX2000, 50 μm, 12 fibers	NXC-RPFL-PGPNNN-STPFBN-N-01.5
Single-mode, 12 fibers	NXC-RPSL-PGANNN-STSFBN-N-01.5
Multi-fiber Cable Assembly, MPO(m)-SC	
Multimode FX300, 62.5 μm, 12 fibers	NXC-RPML-PGPNNN-SCPFBN-N-01.5
Multimode FX600, 50 μm, 12 fibers	NXC-RPNL-PGPNNN-SCPFBN-N-01.5
Multimode FX2000, 50 μm, 12 fibers	NXC-RPFL-PGPNNN-SCPFBN-N-01.5
Single-mode, 12 fibers	NXC-RPSL-PGANNN-SCSFBN-N-01.5
Multi-fiber Cable Assembly, MPO(m)-LC	
Multimode, FX300, 62.5 μm, 12 fibers	NXC-RPML-PGPNNN-LCPFBN-N-01.5
Multimode FX600, 50 μm, 12 fibers	NXC-RPNL-PGPNNN-LCPFBN-N-01.5
Multimode FX2000, 50 μm, 12 fibers	NXC-RPFL-PGPNNN-LCPFBN-N-01.5
Single-mode, 12 fibers	NXC-RPSL-PGANNN-LCSFBN-N-01.5
Multi-fiber Cable Assembly, MPO(m)-MTRJ(m)	
Multimode FX300, 62.5 μm, 12 fibers	NXC-RPML-PGPNNN-JBPFBN-N-01.5
Multimode FX600, 50 μm, 12 fibers	NXC-RPNL-PGPNNN-JBPFBN-N-01.5
Multimode FX2000, 50 μm, 12 fibers	NXC-RPFL-PGPNNN-JBPFBN-N-01.5
Single-mode, 12 fibers	NXC-RPSL-PGANNN-JBSFBN-N-01.5

These products are in the process of being assessed for RoHS compliance. Please check our Web Site for the most current RoHS status.

FiberExpress Pre-Connectorized Assemblies

FiberExpress Bar

AX250001 FiberExpress Bar 12ST



MX100154 FiberExpress MPO Adapter



FiberExpress Bar

The **FiberExpress Bar** consists of a custom length fiber cable with, at one end, a factory pre-terminated rugged mini patch panel and, at the other end, a factory installed multi-fiber MPO connector. The very compact fiber patch panel contains 6 or 12 factory-terminated and tested connectors in a variety of styles. The ruggedness of the FiberExpress Bar makes it an ideal candidate for disaster recovery, industrial applications and other fiber deployment in harsh environment.

FiberExpress Bar Accessories

The **MPO Adapter** is the sleeve that provides primary alignment and locking when connecting the two MPO connectors (male to female). It has a flange and a metal clip for panel mounting and it is included with each FiberExpress Bar (1m with male connector).

The **19 in. Rack Mount Housing** is a 1U metal panel that holds 1 FiberExpress Bar. It has a live hinge on the left-hand side and swings out giving access to the MPO connection and facilitate cable management and slack storage when used with the Slack Storage Tray.

The **Front Cover** is a smoked Plexiglas cover that protects the fiber cords connected to the FiberExpress Bar. It has 2 push rivets for positive locking and easy handling.

The **Slack Storage Tray** attaches to the back of the 19 in. Rack Mount Housing to facilitate cable management and slack storage. It has a storage capacity of 5 meters of 12-fiber ribbon cable.

The **Wall Mount Enclosure** can contain one FiberExpress Bar. It is made of heavy gauge steel and has a locking cover.

Description	Belden Part Number	
	Multimode, FX300, 62.5 μm	Multimode, FX600, 50 μm

FiberExpress Pre-Connectorized Assemblies

FiberExpress Bar		
12 ST type, MPO (m), 1 m	AX250001	AX250052
6 SC duplex, MPO (m), 12 fibers, 1 m	AX250005	AX250054
6 MT-RJ, MPO (m), 12 fibers, 1 m	AX250178	AX250179
12 LC, MPO (m), 1 m	AX250539	AX250540
	Multimode, FX2000, 50 μm	Single-mode
12 ST type, MPO (m), 1 m	AX250459	AX250009
6 SC duplex, MPO (m), 12 fibers, 1 m	AX250460	AX250011
6 MT-RJ, MPO (m), 12 fibers, 1 m	AX250461	AX250180
12 LC, MPO (m), 1 m	AX250541	AX250542

Also available for 6 fibers, please contact Customer Service for more details.

FiberExpress Bar Accessories	
MPO Adapter (6 or 12 fibers) included with each FiberExpress Bar (1 m - Male)	MX100154
19 in. Rack Mount Housing for FiberExpress Bar, Gray	AX100331
19 in. Rack Mount Housing for FiberExpress Bar, Black	AX100330
Front Cover for FiberExpress rack mount housing	AX100332
Slack Storage Tray for FiberExpress Bar, (capacity: 5 meters) including top cover, Gray	AX100329
Slack Storage Tray for FiberExpress Bar, (capacity: 5 meters) including top cover, Black	AX100328
Wall Mount Enclosure, can contain one bar, Black	AC200004

These products are in the process of being assessed for RoHS compliance. Please check our Web Site for the most current RoHS status.

FiberExpress Secure/Keyed LC System

Optimax Field Installable Connectors and Patch Cords & Pigtails

AX102197 Secure/Keyed LC Optimax



Secure/Keyed LC System

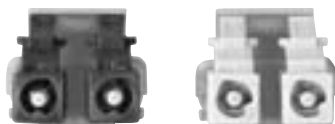

FiberExpress Secure/Keyed LC System

The **FiberExpress Secure/Keyed LC System** allows for physical segregation of networks segments in secure fiber cabling infrastructures. All Secure/Keyed LC products are available with 6 different keying options each carrying a different color to facilitate network administration. The keying detail inside the connector is totally tamper-resistant and cannot be re-produced inside a standard LC connector to violate the network security. All products comply with the FOCIS 10 standard and optical performance exceeds all industry standards for SFF connectors.

The **Secure/Keyed LC Optimax field installable connectors** are available in Multimode 50 µm laser-optimized and 62.5 µm fiber versions. They are high-quality connectors that use a ceramic ferrule with a physical contact (PC) polish for Multimode connectors.

The **Secure/Keyed LC Patch Cords and Pigtails** are offered in Multimode 62.5 µm (FX300), 50/125 µm (FX600) and laser-optimized 50/125 µm (FX2000) for the most demanding network performance.

Description	Belden Part Number					
	K1, Red	K2, Green	K3, Yellow	K4, Black	K5, Orange	K6, Blue

FiberExpress Secure/Keyed LC System

Secure/Keyed LC Optimax*						
Multimode 62.5 µm**	AX102203	AX102204	AX102205	AX102206	AX102207	AX102208
Multimode 50 µm**	AX102197	AX102198	AX102199	AX102200	AX102201	AX102202

**For 900 µm buffered fiber only. The same accessory kit (AX101984) is used for 2 mm jacketed cable connector termination as for our regular Optimax LC offering.

Secure/Keyed LC Duplex Patch Cord, KEYx-KEYx*						
2 m (6 ft.), Multimode FX300, 62.5 µm	AX201365	AX201366	AX201367	AX201368	AX201369	AX201370
2 m (6 ft.), Multimode FX600, 50 µm	AX201383	AX201384	AX201385	AX201386	AX201387	AX201388
2 m (6 ft.), Multimode FX2000, 50 µm	AX201401	AX201402	AX201403	AX201404	AX201405	AX201406
3 m (10 ft.), Multimode FX300, 62.5 µm	AX201371	AX201372	AX201373	AX201374	AX201375	AX201376
3 m (10 ft.), Multimode FX600, 50 µm	AX201389	AX201390	AX201391	AX201392	AX201393	AX201394
3 m (10 ft.), Multimode FX2000, 50 µm	AX201407	AX201408	AX201409	AX201410	AX201411	AX201412
5 m (16 ft.), Multimode FX300, 62.5 µm	AX201377	AX201378	AX201379	AX201380	AX201381	AX201382
5 m (16 ft.), Multimode FX600, 50 µm	AX201395	AX201396	AX201397	AX201398	AX201399	AX201400
5 m (16 ft.), Multimode FX2000, 50 µm	AX201413	AX201414	AX201415	AX201416	AX201417	AX201418

Secure/Keyed LC Duplex Hybrid Patch Cord, KEYx-LCD*						
2 m (6 ft.), Multimode FX300, 62.5 µm	AX201419	AX201420	AX201421	AX201422	AX201423	AX201424
2 m (6 ft.), Multimode FX600, 50 µm	AX201437	AX201438	AX201439	AX201440	AX201441	AX201442
2 m (6 ft.), Multimode FX2000, 50 µm	AX201455	AX201456	AX201457	AX201458	AX201459	AX201460
3 m (10 ft.), Multimode FX300, 62.5 µm	AX201425	AX201426	AX201427	AX201428	AX201429	AX201430
3 m (10 ft.), Multimode FX600, 50 µm	AX201443	AX201444	AX201445	AX201446	AX201447	AX201448
3 m (10 ft.), Multimode FX2000, 50 µm	AX201461	AX201462	AX201463	AX201464	AX201465	AX201466
5 m (16 ft.), Multimode FX300, 62.5 µm	AX201431	AX201432	AX201433	AX201434	AX201435	AX201436
5 m (16 ft.), Multimode FX600, 50 µm	AX201449	AX201450	AX201451	AX201452	AX201453	AX201454
5 m (16 ft.), Multimode FX2000, 50 µm	AX201467	AX201468	AX201469	AX201470	AX201471	AX201472

Secure/Keyed LC Duplex Hybrid Patch Cord, KEYx-SCD*						
2 m (6 ft.), Multimode FX300, 62.5 µm	AX201473	AX201474	AX201475	AX201476	AX201477	AX201478
2 m (6 ft.), Multimode FX600, 50 µm	AX201491	AX201492	AX201493	AX201494	AX201495	AX201496
2 m (6 ft.), Multimode FX2000, 50 µm	AX201509	AX201510	AX201511	AX201512	AX201513	AX201514
3 m (10 ft.), Multimode FX300, 62.5 µm	AX201479	AX201480	AX201481	AX201482	AX201483	AX201484
3 m (10 ft.), Multimode FX600, 50 µm	AX201497	AX201498	AX201499	AX201500	AX201501	AX201502
3 m (10 ft.), Multimode FX2000, 50 µm	AX201515	AX201516	AX201517	AX201518	AX201519	AX201520
5 m (16 ft.), Multimode FX300, 62.5 µm	AX201485	AX201486	AX201487	AX201488	AX201489	AX201490
5 m (16 ft.), Multimode FX600, 50 µm	AX201503	AX201504	AX201505	AX201506	AX201507	AX201508
5 m (16 ft.), Multimode FX2000, 50 µm	AX201521	AX201522	AX201523	AX201524	AX201525	AX201526

Secure/Keyed LC Pigtail, KEYx-open*						
2 m (6 ft.), Multimode FX300, 62.5 µm	AX201527	AX201528	AX201529	AX201530	AX201531	AX201532
2 m (6 ft.), Multimode FX600, 50 µm	AX201533	AX201534	AX201535	AX201536	AX201537	AX201538
2 m (6 ft.), Multimode FX2000, 50 µm	AX201539	AX201540	AX201541	AX201542	AX201543	AX201544

Other Patch Cord lengths and configurations may be available, please contact Customer Service for more details.

These products are in the process of being assessed for RoHS compliance. Please check our Web Site for the most current RoHS status. * Patent Pending.



FiberExpress Secure/Keyed LC System

Adapter Modules, Adapter Strips and FiberExpress Manager Modules

AX102098 Secure/Keyed LC Adapter Module

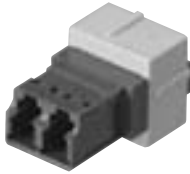

AX102124 Secure/Keyed LC Adapter Strip



AX102114 Secure/Keyed LC FiberExpress Manager Module

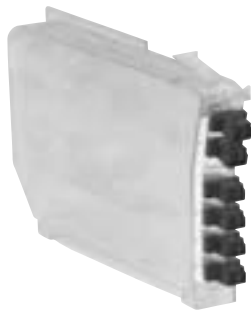

FiberExpress Secure/Keyed LC System

The **FiberExpress Secure/Keyed LC System** allows for physical segregation of networks segments in secure fiber cabling infrastructures. All Secure/Keyed LC products are available with 6 different keying options each carrying a different color to facilitate network administration. The keying detail inside the connector is totally tamper-resistant and cannot be re-produced inside a standard LC connector to violate the network security. All products comply with the FOCIS 10 standard and optical performance exceeds all industry standards for SFF connectors.

The **Secure/Keyed LC Adapter Modules and Adapter Strips** can be used in all mounting hardware for workstation area, Consolidation Point or Telecom Room applications.

The **Secure/Keyed LC FiberExpress Manager Modules** can be used in 19 and 23 inch *FiberExpress* Manager Shelves to provide a high-density management system of up to 1920 terminated fibers per rack.

Description	Belden Part Number					
	K1, Red	K2, Green	K3, Yellow	K4, Black	K5, Orange	K6, Blue
FiberExpress Secure/Keyed LC System						
Secure/Keyed LC Adapter Module*						
Gray holder	AX102089	AX102090	AX102091	AX102092	AX102093	AX102094
Almond holder	AX102095	AX102096	AX102097	AX102098	AX102099	AX102100
White holder	AX102101	AX102102	AX102103	AX102104	AX102105	AX102106
Black holder	AX102107	AX102108	AX102109	AX102110	AX102111	AX102112
Secure/Keyed LC FiberExpress Adapter Strip*						
12 fibers	AX102119	AX102120	AX102121	AX102122	AX102123	AX102124
24 fibers	AX102125	AX102126	AX102127	AX102128	AX102129	AX102130
Secure/Keyed LC FiberExpress Manager Module*						
12 fibers	AX102113	AX102114	AX102115	AX102116	AX102117	AX102118
24 fibers	AX102310	AX102311	AX102312	AX102313	AX102314	AX102315

* Patent Pending.

These products are in the process of being assessed for RoHS compliance. Please check our Web Site for the most current RoHS status.

FiberExpress Manager

Rack Components and Modules

AX100934 FiberExpress Manager Shelf



AX101943 FiberExpress Manager 1U Rack Mount Patch Panel



AX102032 FiberExpress Manager 1U Cable Management Accessory



AX101525 Connector Module Pre-terminated MPO-MT-RJ

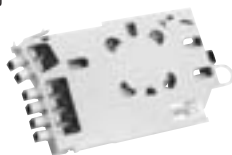

FiberExpress Manager Shelf

FiberExpress modules are rack-mounted using FiberExpress Manager Shelves. The shelves provide the total system with extra high connection density while facilitating cable routing and patch cord management. For 19- or 23-inch rack: 19 in. shelf holds up to 12 modules; 23 in. shelf holds up to 16 modules.

FiberExpress Manager 1U

The **FiberExpress Manager 1U Rack Mount Patch Panel** is a low-cost, compact assembly designed for interconnection or splicing of optical fiber cables, using up to three FiberExpress Manager Modules. The low-profile design minimizes rack space to only 45 mm (1.75 in.). An optional FiberExpress Manager 1U Cable Management Accessory is also available.

FiberExpress Manager Connector Module

The **Connector Module** is the basic building block of the FiberExpress Manager. It is designed with a unique release mechanism that allows it to slide from the shelf like a PC card, easing management of patch cords.

Description	Belden Part Number	
	Gray	Black
FiberExpress Manager		
FiberExpress Manager		
Shelf, 23 in., 10.9 kg (24 lb)	AX100934	AX100935
Shelf, 19 in., 8.2 kg (18 lb)	AX101084	AX101085
1U, Rack Mount Patch Panel, 19 in., 5 kg (11 lb)	AX101944	AX101943
1U, Cable Management Accessory, 19 in., 1 kg (2 lb)	AX102033	AX102032

Description	Belden Part Number					
	ST Type	SC Simplex	SC Duplex	SC Duplex (ST in)	LC	FC
FiberExpress Manager						
FiberExpress Manager Connector Module						
Metal Sleeve, Multimode, 6 fibers	AX101089		AX101092			
Zirconia Ceramic, Single-mode, 6 fibers	AX100936	AX100943	AX100944			
Metal Sleeve, Multimode, 12 fibers	AX101187		AX101714	AX101120	AX101528	
Zirconia Ceramic, Single-mode, 12 fibers	AX101186		AX101713	AX101119	AX101527	
Zirconia Ceramic, Single-mode, 12 UPC pigtails			AX101715			
Metal Sleeve, Multimode, 24 fibers					AX102306	
Zirconia Ceramic, Single-mode, 24 fibers					AX102305	
Zirconia Ceramic, Single-mode/Multimode, 6 fibers						AX100937
		Multimode 62.5 µm	Multimode 50 µm	Single-mode		
MPO(m)-ST type, 12 pre-terminated	AX101189		AX101190	AX101188		
MPO(m)-SC Duplex, 12 pre-terminated	AX101091		AX101114	AX101090		
MPO(m)-MT-RJ(m), 12 pre-terminated	AX101525		AX101526	AX101524		
MPO(m)-LC, 12 pre-terminated	AX101530		AX101531	AX101529		
MPO(m)-LC, 24 pre-terminated	AX102309		AX102308	AX102307		
MT-RJ, Beige, Multimode, 12 fibers						AX101096
MT-RJ, Blue, Single-mode, 12 fibers						AX101581

These products are in the process of being assessed for RoHS compliance. Please check our Web Site for the most current RoHS status.

FiberExpress Patch Panels

Rack Mount Patch Panels

AX100041 FiberExpress, 12/24 Port (1U)
Rack Mount Patch Panel



AX100069 FiberExpress, 24/48 Port (2U)
Rack Mount Patch Panel

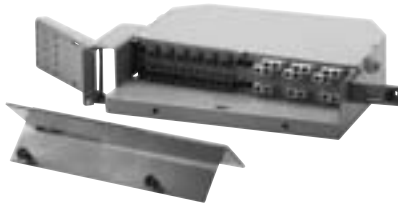

AX100078 FiberExpress (3U) Rack Mount Patch Panel



AX100115 FiberExpress, 48/96 Port (4U) Rack Mount
Patch Panel



FiberExpress Rack Mount Patch Panel 1U and 2U

The **FiberExpress 1U and 2U Rack Mount Patch Panels** are equipped with a special hinge that allows easy access to the rear of the patch panel without disturbing the optical fiber cable. A specially designed front panel allows connector protection and easy routing of optical fiber patch cords. The **FiberExpress** Rack Mount Patch Panels are also compatible with our 203 mm (8 in.) Splice Organizer Trays. This allows the optical fiber cable to be either terminated with fiber single-ended patch cords or field-installable connectors. The patch panels can be used with ST Compatible, SC, 568SC, FC, LC or MT-RJ adapters strips (ordered separately).

The **FiberExpress 1U Rack Mount Patch Panel** is a low-cost, compact assembly designed for interconnection or splicing of optical fiber cables, from 12 up to 48 fibers if MT-RJ or LC double density adapter strips are used. The low-profile design minimizes rack space to only 45 mm (1.75 in.). An optional smoked Plexiglass front cover is also available.

The **FiberExpress 2U Rack Mount Patch Panel** offers a high fiber capacity, 96 fibers if using double density MT-RJ or LC adapter strips. The **FiberExpress 2U** comes equipped with a smoked Plexiglass front cover that protects fiber connections while allowing for quick visual inspection.

FiberExpress Rack Mount Patch Panel 3U

The **FiberExpress 3U Rack Mount Patch Panel** can accommodate up to 96 optical fiber connections using MT-RJ or LC connectors. The connector panel is mounted on a sliding drawer for easy access to the back side (cable side) of the panel. The **FiberExpress 3U Rack Mount Patch Panel** can be used with either optical fiber single-ended patch cords or field-installable connectors. If optical single-ended patch cords are to be used, organizer trays are easily accessible via the removable front access pull-out drawer. (Trays must be ordered separately.)

The **FiberExpress 3U Rack Mount Patch Panel** is a compact cross-connect assembly for the termination of optical fiber cables. The low-profile design minimizes required rack space to 127 mm (5 in.). It is compatible with ST Compatible, SC, 568SC, MT-RJ, LC and FC adapters strips (ordered separately).

FiberExpress Rack Mount Patch Panel 4U

The **FiberExpress 4U Rack Mount Patch Panel** is an economical solution for the protection of optical fiber terminations and splices, up to 192 optical fibers if using MT-RJ or LC connectors. The connector panel, accepting the Universal Adapter Strips, is located inside the enclosure and swings out (left or right) to give easy access to the cable and splices.

The **FiberExpress 4U Rack Mount Patch Panel** is a compact Cross-Connect enclosure for the cross-connection, interconnection or splicing of optical fiber cables. The low-profile design minimizes required rack space to 178 mm (7 in.). It can be used with ST Compatible, SC, 568SC, MT-RJ, LC and FC adapters strips (ordered separately).

Description	Belden Part Number
FiberExpress Patch Panels	
FiberExpress Rack Mount Patch Panel 1U*	
Gray	AX100042
Black	AX100041
FiberExpress Rack Mount Patch Panel 2U*	
Gray	AX100069
Black	AX100068
FiberExpress Rack Mount Patch Panel 3U	
Gray	AX100078
Black	AX100077
FiberExpress Rack Mount Patch Panel 4U	
Gray	AX100115
Black	AX100116

If Single-ended patch cords are to be spliced to the fiber cable, don't forget to order Splice Organizer Trays or Kits. Both these, and the Universal Adapter Strips can be ordered in the **FiberExpress Accessories** section.

*IMPORTANT: The **FiberExpress 1U** accepts two (2) 203 mm (8 in.) splice trays.
The **2U** accepts four (4) 203 mm (8 in.) splice trays.

These products are in the process of being assessed for RoHS compliance. Please check our Web Site for the most current RoHS status.

FiberExpress Patch Panels

Rack Mount Accessories and Wall Mount Patch Panels

AX101800 127 mm (5 in.) Universal Offset Bracket Kit, for 19 in. and 23 in. Racks 1U

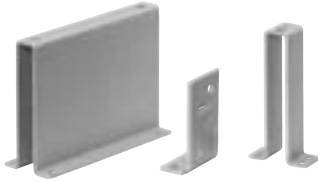

AX101802 23 in. Rack Universal Extension Bracket for 1U and 2U



AX100047 Right Side Cable Entry Bracket for 1U



AX100045 Front Cover for 1U



AX100543 Large Wall Mount



FiberExpress Rack Mount Patch Panels 1U and 2U Accessories

The accessories provide additional panel mounting flexibility for racks, cabinets and cable entry.

Description	Belden Part Number
FiberExpress Patch Panels	
Rack Mount Accessories (1U and 2U)	
127 mm (5 in.) Universal Offset Bracket Kit:	
for 19 in. and 23 in. racks (1U), Black	AX101799
for 19 in. and 23 in. racks (1U), Gray	AX101800
for 19 in. and 23 in. racks (2U), Black	AX101797
for 19 in. and 23 in. racks (2U), Gray	AX101798
23 in. Universal extension bracket, Black	AX101801
23 in. Universal extension bracket, Gray	AX101802
Right side cable entry bracket (1U), Black	AX100046
Right side cable entry bracket (1U), Gray	AX100047
Right side cable entry bracket (2U), Black	AX100073
Right side cable entry bracket (2U), Gray	AX100074
Front Cover (1U), Smoked Plexiglass	AX100045

FiberExpress Wall Mount Patch Panel

The FiberExpress Wall Mount Patch Panel Series is an economical solution for the protection of optical fiber terminations and splices in hostile environments.

Using the FiberExpress Universal Adapter Strips (ordered separately), the Wall Mount Patch Panels allow for flexible and customized patch panel design. They are compatible with most industry standard connections: ST Compatible, SC, 568SC, MT-RJ, LC and FC.

Available in gray and black, the FiberExpress Wall Mount Patch Panels have an ergonomic design, rugged construction and compact assemblies to effectively protect your optical fiber terminations and splices.

Description	Belden Part Number
FiberExpress Patch Panels	
Wall Mount	
Small, Gray	AX100496
Small, Black	AX100495
Medium, Gray	AX100541
Medium, Black	AX100540
Large, Gray	AX100543
Large, Black	AX100542

If optical Single-ended patch cords are to be spliced to the fiber cable, don't forget to order Splice Organizer Trays or Kits in FiberExpress Accessories section. Universal Adapter Strips can be ordered in FiberExpress Patch Panels section.

These products are in the process of being assessed for RoHS compliance. Please check our Web Site for the most current RoHS status.

AX100541 Medium Wall Mount



AX100495 Small Wall Mount



FiberExpress Patch Panels Accessories

Universal Optical Fiber Adapter Strips and Accessories

AX101729 Adapters loaded with 6 LC Duplex



AX100094 Adapters loaded with 3 SC Duplex



AX100066 Blank Strip



AX101100 Field Breakout Kit

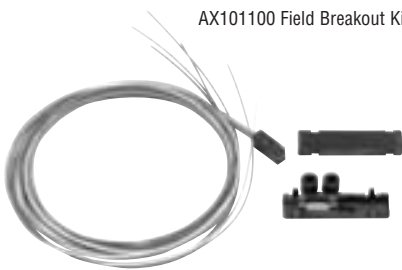

A0649869 Optical Fiber Splice Organizer Kits and Trays



AX100945 Flex Kit



AX101098 Splice Holder Kit

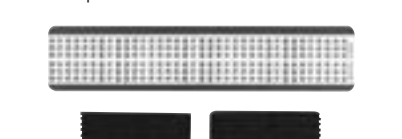

Optical Fiber Adapter Strips

Universal Optical Fiber Adapter Strips are pre-loaded with six (single density) or 12 (double density) adapter sleeves. Two types of adapter sleeves are available: Phosphor Bronze and Zirconia Ceramic. Adapter sleeves are used as the connecting interface between two optical fiber connectors.

A **Blank adapter strip** is also available and can be used with any FiberExpress Patch Panel to fill in unused adapter strip openings.

Optical Fiber Accessories

The Field Breakout Kit is designed to attach to one tube of a loose-tube cable. Each kit has either six or twelve 900 µm tubes that hold each of the coated fibers. For each end of the cable, one kit is needed for every tube. For example, a 12-fiber 62.5 µm cable contains two 6-fiber tubes. This cable would require four kits, two for each end.

Optical Fiber Splice Organizer Kits provide the accessories necessary for installing the FiberExpress Fiber Patch Panels, as well as other fiber terminals that accommodate the standard Belden organizer tray.

The Flex Kit contains tubes and manifolds designed to split cables into individual fiber strands, and is suitable for 6 fibers up to 12 fibers. It is necessary for use with loose tube cables or when the fiber cable count does not match the number of connections in the FiberExpress Manager Connector Module. The Flex Kit tubes help to maintain proper fiber bend radius. One kit is required per 12 modules (one 19 in. shelf).

A **Splice Holder Kit** can be used to hold fusion or mechanical splices. Each splice holder can handle up to 6 splices.

Description	Belden Part Number	
	Phosphor Bronze, Multimode	Zirconia Ceramic, Single-mode

FiberExpress Optical Fiber Adapter Strips

Single Density, Black		
Loaded with 6 ST Compatible Adapters	AX100088	AX100534
Loaded with 3 SC Duplex Adapters	AX100094	AX101407
Loaded with 6 SC Simplex Adapters	AX100092	AX100538
Loaded with 6 FC Adapters	AX100090	AX100536
Loaded with 6 LC Duplex Adapters	AX101729	AX101731
MT-RJ, loaded with 6 MT-RJ, Multimode/Single-mode	AX101115	
Double Density, Black		
Loaded with 12 ST Compatible Adapters	AX100080	AX100528
Loaded with 6 SC Duplex Adapters	AX100098	AX101409
Loaded with 12 SC Simplex Adapters	AX100084	AX100532
Loaded with 12 FC Adapters	AX100082	AX100530
Loaded with 12 LC Duplex Adapters	AX101741	AX101743
MT-RJ, loaded with 12 MT-RJ, Multimode/Single-mode	AX101117	
Blank Strip		
Black	AX100066	

FiberExpress Accessories

Optical Fiber Field Breakout Kit	
6 fibers, 1/pack	AX101100
12 fibers, 1/pack	AX101101
Optical Fiber Splice Organizer Kit	
Splice kit, tray, 203 mm (8 in.)	A0649869
Splice kit, tray, 305 mm (12 in.)	A0318904
Optical Fiber Splice Tray	
Fusion, 203 mm (8 in.)	A0335015
Fusion, 305 mm (12 in.)	A0316446
Universal (mechanical or fusion), 203 mm (8 in.)	AX100079
Universal (mechanical or fusion), 305 mm (12 in.)	A0394328
Tray cover, 203 mm (8 in.)	A0394331
Tray cover, 305 mm (12 in.)	A0394330
Flex Kit	AX100945
Splice Holder Kit	AX101098

These products are in the process of being assessed for RoHS compliance. Please check our Web Site for the most current RoHS status.



FiberExpress Outlets

MediaFlex Plates and Inserts

AX101869 MediaFlex Plate, Double Gang



AX101874 MediaFlex Adapter Box, Double Gang

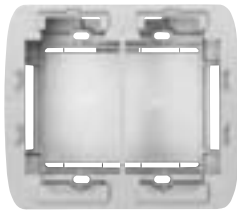

AX101756 MediaFlex MDVO (style) Insert, 2-port, Angled

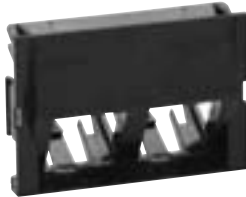

AX101937 MediaFlex SC Duplex Insert, Angled

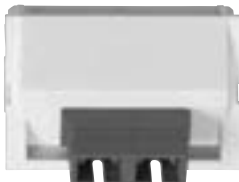

MediaFlex Plate

MediaFlex Plates are one part of the comprehensive line of plates and inserts that snap together to create a full line of modular workstation outlets.

MediaFlex Plates can be mounted over standard NEMA type outlet boxes and rings to provide support for a variety of MediaFlex Adapters and Inserts. The fully modular construction combined with the front access design provides extensive configuration flexibility for current and future network needs. MediaFlex Plates are available in Single Gang and Double Gang configurations.

The Double Gang faceplate comes with a stand-off ring included in the package. This ring allows for easy mounting with virtually any industry electrical box or mud/adaptor rings, therefore providing added installation flexibility.

Each plate has the capacity of up to 6 ports per Single Gang and 12 ports per Double Gang.

MediaFlex Adapter Box

MediaFlex Surface Adapter Boxes are one part of the comprehensive line of plates and inserts that snap together to create a full line of modular workstation outlets.

MediaFlex Surface Adapter Boxes can be mounted over standard NEMA type outlet boxes and rings to provide support for the MediaFlex plates. The MediaFlex Surface Adapter Boxes are available as a Double Gang configuration. The Double Gang box allows more room for cable management and bend radius control.

MediaFlex MDVO (style) Insert

MediaFlex MDVO-style Inserts are available in a 2-port configuration in both Flush and Angled versions. They are compatible with all GigaFlex and MDVO Modules (EZ-MDVO and Multimedia). The inserts are two units high for the flush version and three units high for the angled version. Therefore three flush inserts or two angled inserts are required to fully populate a Single Gang MediaFlex Plate.

MediaFlex Multimedia Insert

MediaFlex Multimedia Inserts provide optimum flexibility in configuring multimedia workstation outlets that respond to any present or future network needs. MediaFlex Multimedia Inserts along with other MediaFlex Inserts allow for easy configuration of outlets. All inserts are front loaded and easily snapped in and out of the MediaFlex Plates for easy installation and maintenance.

MediaFlex Multimedia Inserts are available in Angled versions only in order to allow for proper management of cable bend radius. The inserts are three units high, therefore two inserts are required to fully populate a Single Gang faceplate and four inserts will fully populate a Double Gang faceplate.

Description	Belden Part Number					
	Gray	Almond	Elec. White	Black	White	Ivory
FiberExpress Outlets						
MediaFlex Plate						
Single Gang	AX101745	AX101746	AX101747	AX101748	AX102608	AX102569
Double Gang	AX101869	AX101870	AX101871	AX101872	AX102609	AX102570
MediaFlex Adapter Box						
Single Gang	AX102480	AX102481	AX102482	AX102483	AX102484	AX102485
Double Gang	AX101873	AX101874	AX101875	AX101876	AX102610	AX102571
MediaFlex MDVO (style) Insert						
2-port, Flush, bag of 10 units	AX101749	AX101750	AX101751	AX101752	AX102612	AX102572
2-port, Angled, bag of 10 units	AX101753	AX101754	AX101755	AX101756	AX102613	AX102573
MediaFlex SC Duplex						
SC Duplex Single-mode	AX101935	AX101936	AX101937	AX101938	AX102619	AX102649
SC Duplex Multimode	AX101939	AX101940	AX101941	AX101942	AX102620	AX102650

These products are in the process of being assessed for RoHS compliance. Please check our Web Site for the most current RoHS status.



FiberExpress Outlets

MDVO Multimedia Outlet Boxes & Modules and Multi-User Outlet Boxes

A0643205 MDVO Multimedia Outlet Box, shown here as terminated

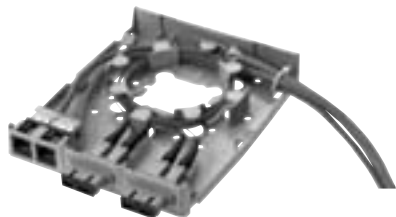

A0407005 MDVO SC Fiber Module

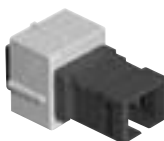

A0649254 SC Duplex Adapter



A0407010 MDVO ST Compatible Fiber Module



AX101467 MDVO MT-RJ Fiber Module



AX100222 Multi-User Outlet Box, shown here with modules



MDVO Multimedia Outlet Box

The **MDVO Multimedia Outlet Box** brings unique versatility for multimedia work area installations. The box design provides cable management and helps maintain cable bend radius. The outlet box's low profile design and side-entry offers better protection for patch cords. The outlet box can accept up to six EZ-MDVO, GigaFlex or MDVO Multimedia Modules or three SC Duplex adapters.

The MDVO Multimedia Outlet Box can be mounted directly on the wall or attached to standard electrical boxes. Included with the MDVO Multimedia box are three SC Duplex Mounting bezels and three MDVO Adapters.

MDVO Multimedia Modules

MDVO Multimedia Modules address audio/video and fiber applications. Fiber modules are available for LC Duplex, SC Simplex, ST Compatible multimode and MT-RJ multimode & single-mode connections. The SC Duplex Adapter is a fiber adapter sleeve with flanges that mounts into the SC Duplex mounting bezel (included in the MDVO Multimedia Outlet box). Audio/video modules are available for SVHS, RCA, BNC and Video F connections.

Multi-User Outlet Box

The **Multi-User Outlet Box** is a versatile box that can be used in many different applications. The outlet box can accommodate up to 24 connections of any type, UTP, fiber or coax. The outlet box is ideal for use as a multi-user telecommunications assembly, or simply as a high-density multimedia telecommunications outlet. The Multi-User Outlet Box can also be used as a wall mounted patch panel in confined areas, such as shallow rooms and cabinets.

Description	Belden Part Number			
	Gray	Almond	White	Black

FiberExpress Outlets

MDVO Multimedia Outlet Box				
6-port	A0643205	A0643206	A0643207	A0643208
Please note that SC Duplex adapters must be ordered separately (A0649254).				
MDVO Multimedia Module				
LC Duplex Multimode	AX102209	AX102210	AX102211	AX102212
LC Duplex Single-mode	AX102213	AX102214	AX102215	AX102216
SC Simplex, Multimode, Blue insert	A0407003	A0407004	A0407005	A0407006
SC Duplex Adapter, Multimode	A0649254			
ST Compatible, Multimode	A0407007	A0407008	A0407009	A0407010
MT-RJ, Multimode	AX101467			
MT-RJ, Single-mode, Blue	AX101466			

Custom multimedia connectors are also available, please contact Customer Service for more details.

Multi-User Outlet Box				
24-port	AX100219	AX100220	AX100221	AX100222

These products are in the process of being assessed for RoHS compliance. Please check our Web Site for the most current RoHS status.

Network Connectivity Products

Media Converters, Transceivers & Hubs and Network Tester

Media Converters

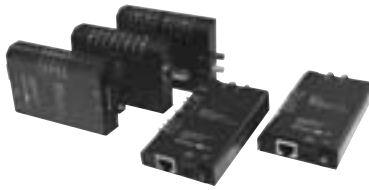

Media Converters for Ethernet and Fast Ethernet

Media Converters enable the connection of dissimilar network cabling types, while maintaining the same network speed. A legacy Thinnet segment can be connected to a 10Base-T Hub or switch port with an AX-200 Converter or, link two different 10Base-T networks together over a multimode fiber optic link with a pair of AX-270s. Connect a legacy Thinnet segment over fiber with the AX-280 converter. The AX-5270 can be used for interbuilding links or attached to a fiber backbone.

AX-1912 Media Converter Rack



Transceivers and Ethernet Hubs

The AX-50, 70 and 80 Transceivers enable the connection of a legacy AUI port to 10Base-T, Thinnet, or Fiber Optic media. The transceiver is powered from the host and requires no external power supply.

The AX-509 Ethernet Hub has an AUI port which accepts UTP, Fiber Optic or BNC transceivers. Specified for use by many U.S. Government Agencies. Includes a 110v/12v power supply.

AX050, 70 and 80 Transceivers and AX-509 Ethernet Hub

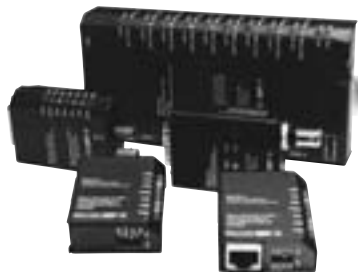

Realtime 10/100 Base-TX Ethernet Network Test Unit

The AX-110BT Realtime 10/100 Base-TX Ethernet Network Test Unit is a cost effective way to quickly determine a network's operating condition. Plug the unit's patch cord into the tester, then into any open RJ-45 jack in an office, cubicle or conference room. Immediately see if the jack is a live network node capable of either 100 Mb/s or 10 Mb/s. Next check patch cord continuity and polarity. Connect the downlink to a PC to check NIC card link, speed and full or half duplex capabilities. Connect the uplink to a hub or switch port to verify link and speed.

AX-110BT Realtime 10/100 Base-TX Ethernet Network Test Unit



Description	Belden Part Number
Network Connectivity Products	
Media Converter	
10Base-T/10Base2, RJ-45 to BNC	AX-200
10Base-T/10Base-FL, RJ-45 to ST-Compatible fiber connectors	AX-270
10Base2/10Base-FL, BNC to ST-Compatible fiber connectors	AX-280
100Base-TX/100Base-FX, SC-Compatible fiber connectors	AX-5270SC
100Base-TX/100Base-FX, ST-Compatible fiber connectors	AX-5270ST
Media Converter Rack	
Holds up to 12 converters and multi lead power supplies, 19 in. rack-mount ready	AX-1912-MCR
Power Supply, 4-lead 110v/12v, powers up to 4 converters	AX-270P4U
Power Supply, 8-lead 110v/12v, powers up to 8 converters	AX-270P8U
Transceivers and Ethernet Hubs	
UTP Transceiver, 10Base-T, AUI to RJ-45, side port	AX-50
UTP Transceiver, 10Base-T, AUI to RJ-45, rear port	AX-50R
Fiber Transceiver, 10Base-FL, AUI to ST-Compatible	AX-70
Thinnet Transceiver, 10Base2, AUI to BNC	AX-80
Ethernet Hub with 8 RJ-45 10Base-T ports and 1 AUI port	AX-509
Network Tester	
Realtime 10/100 Base-TX Ethernet Network Test Unit	AX-110BT

These products are in the process of being assessed for RoHS compliance. Please check our Web Site for the most current RoHS status.

Cable Selection Guide

Introduction

The Belden line of Optical Fiber Cables represents a new selection of the best optical fiber cable products offered by the consolidated resources of the Belden organization. The unmatched resources of Belden have now generated a complete line of indoor and outdoor cable products in tight buffered and loose tube constructions. This offering now expands the available applications for Belden optical fiber cable.

Customer Service

Most of our optical fiber cables are available from stock. Many of these are available off-the-shelf from distributors. If you have a new or unusual application, or you cannot find a optical fiber cable in this catalog section that meets your technical requirements, contact Technical Support at 1-800-BELDEN-1 for additional information.

Cable Selection Guide

Optical Fiber Selection

Type	Grade	Fiber Size (μ)	Standards Compliance	Link Length (m)	Data Rate (Gb)
Multimode	6	50/125	exceeds TIA/EIA-568-B.3-1 ISO 11801 OM3	500	10
	5	50/125	TIA/EIA-568-B.3-1 ISO 11801 OM3	300	10
	4	50/125	TIA/EIA-568-B.3	600	1
	3	62.5/125	TIA/EIA-568-B.3	1,000	1
	2	62.5/125	TIA/EIA-568-B.3	550	1
1 [▲]	62.5/125	FDDI grade [†]	—	—	—
Single-mode	—	—	ITU G.652.c/d ^{††}	—	—

[▲] Grade 1 fibers are available upon request.

[†] Used in most current cable plants, but not recommended for future installations, except as patch cordage

^{††} Low water peak fiber with advantages for CWDM applications

Color Code Charts

Jacket Color Chart

Cable Type	Jacket Color
Loose Tube & Outside Plant Cables	Black
Industrial Tray Cables	Orange
Tight Buffered Cables	
Grades 2,3,4	Orange
Grades 5,6	Aqua
Single-mode	Yellow

Nonstandard jacket colors are available upon request.

Fiber Sub-unit Color Code Chart*

Fiber/Tube No.	Color	Fiber/Tube No.	Color
1	Blue	7	Red
2	Orange	8	Black
3	Green	9	Yellow
4	Brown	10	Violet
5	Slate	11	Rose
6	White	12	Aqua

*Per EIA/TIA 598-A

Optical Specifications

Grade:	2	3	4	5	6	Single-mode Enhanced ⁶
Glass Type:	62.5/125μ	62.5/125μ	50/125μ	50/125μ	50/125μ	
Operating Wavelength (nm)	850/1300	850/1300	850/1300	850/1300	850/1300	1310/1550
Min. OFL ¹ Bandwidth (MHz-km)	200/500	200/500	500/500	1500/500	3000/500	—
Min. Laser ² Bandwidth (MHz-km)	220/500	385/500	510/500	2000/500	4000/500	—
Max. Attenuation Loose Tube (dB/km)	3.25/1.0	3.25/1.0	3.0/1.0	3.0/1.0	3.0/1.0	0.40/0.30
Max. Attenuation Tight Buffered ³ (dB/km)	3.50/1.25	3.50/1.25	3.50/1.25	3.50/1.25	3.50/1.25	0.80/0.50
100 Mb Fast Ethernet Min. Link Length (meters S/L ⁴)	300/2000	300/2000	300/2000	300/2000	300/2000	—/5000
1 Gb Ethernet Min. Link Length (meters S/L ⁴)	300/550	500/1000	600/600	1000 ⁵ /600	1000 ⁵ /600	—/5000
10 Gb Ethernet Min. Link Length (meters S/L ⁴)	35/300	35/300	85/300	300/300	500/300	—/10,000

¹ OFL = Overfilled Launch

² Effective Modal Bandwidth, determined by RML or DMD performance specifications

³ Max. Attenuation for Tight Buffered, Ribbon, Micro-Loose Tube and Loose Tube Plenum Cables

⁴ S/L = Short wavelength (850 nm) / Long wavelength (1310 nm)

⁵ >2000 meters for engineered links

⁶ Low water peak Single-Mode suitable for CWDM use complies with ITU G.652.c/d



Interconnect Cable — Simplex and Duplex

Tight Buffer — Riser & Plenum Rated

Applications

- Patch panels
- Workstation equipment connections
- Horizontal distribution in open office environments

Product Description

Interconnect Cables are designed for low fiber-count premises environments. They are small and very flexible, making them ideal for confined spaces. Their aesthetic appearance makes these cables suitable for use in open office environments. Available in 1 or 2 fibers. One sub-unit is marked to permit easy identification of transmit and receive fibers. Length markings to facilitate installation.

Jacket Material	PVC
Tight Buffer	PVC
Strength Member	Aramid Yarn
Color Code (Tight Buffer)	Per EIA/TIA 598-A, see page 10.2
Jacket Color	
Single-mode	Yellow
62.5/125 μm	Orange
50/125 μm / 1 Gbe	Orange
50/125 μm / 10 Gbe	Aqua

Ratings

Riser	
UL Type	OFNR
cUL Type	OFN FT4
Flame Resistance	UL 1666
Plenum	
UL Type	OFNP
cUL Type	OFN FT6
Flame Resistance	NFPA 262

Specifications

Temperature Range	
Storage	-40 to +70°C
Operating	-20 to +70°C
Crush Resistance (EIA-455-41)	200 N/cm
Impact Resistance (EIA-455-25)	20 Impacts @ 1.0 N-m
Cyclic Flexing (EIA-455-104)	2000 cycles, min.
Min. Bend Radius	
Installation	15 x OD
Long Term	10 x OD
Optical Specifications	See page 10.2

Fiber Bundle Detail

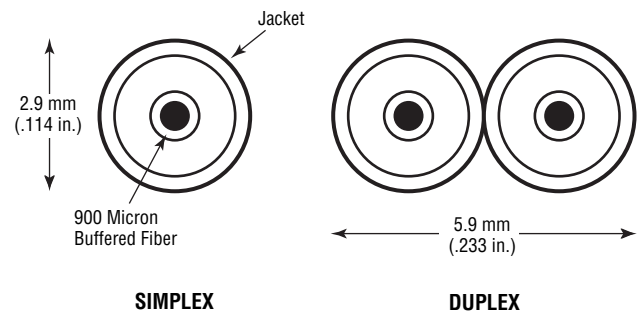

No. of Fibers	Belden Part Number				Outside Diameter		Weight		Max. Install Load	
	62.5 / 125μm Std. / 1 Gbe	50 / 125μm Std. / 1 Gbe	50 / 125μm 10 Gbe – 300M	Single-mode Enhanced	Inch	mm	Lbs./'1000'	kg/km	Lbs.	N

Interconnect Cable Series

Riser (NEC/CEC OFNR/OFN FT4)										
1	M97112	M9A001	M9C001	M9W001	0.114	2.9	6	9	90	400
2	M96915	M9A002	M9C002	M9W002	0.11 x 0.23	2.9 x 5.9	12	18	180	801
Plenum (NEC/CEC OFNP/OFN FT6)										
1	M98086	M9A003	M9C003	M9W003	0.114	2.9	6	9	90	400
2	M96919	M9A004	M9C004	M9W004	0.11 x 0.23	2.9 x 5.9	13	19	180	801

Distribution Cable

Tight Buffer — Indoor Riser, Plenum & LSZH Rated

Applications

- Low to high fiber count requirements
- In-building backbone
- Fiber-to-the-desk applications
- Computer room

Product Description

Flexible thermoplastic jacket provides excellent handling characteristics. Fibers and cable sub-units are color coded for easy identification. Length markings in meters for easy determination of cable length. Full dielectric construction, no grounding required. For Riser offering, MSHA approved cables are available.

Jacket Material	
Riser & Non-unitized Plenum	PVC
Unitized Plenum	PVDF
Low Smoke Zero Halogen	LSZH
Tight Buffer	
Riser & Plenum	PVC
Low Smoke Zero Halogen	LSZH
Strength Member	
	Aramid Yarn
Color Code (Tight Buffer)	
	Per EIA/TIA 598-A, see page 10.2
Jacket Color	
Single-mode	Yellow
62.5/125 μm	Orange (Green for LSZH only)
50/125 μm / 1 Gbe	Orange
50/125 μm / 10 Gbe	Aqua

Ratings

Riser	
UL Type	OFNR
cUL Type	OFN FT4
Flame Resistance	UL 1666
Plenum	
UL Type	OFNP
cUL Type	OFN FT6
Flame Resistance	NFPA 262
Low Smoke Zero Halogen	
UL Type	OFNR
cUL Type	OFN FT4
Flame Resistance	UL 1666

Specifications

Temperature Range	
Storage	-40 to +80°C
Operating	-20 to +70°C
Crush Resistance (EIA-455-41)	2000 N/cm
Impact Resistance (EIA-455-25)	2000 Impacts @ 1.6 N-m
Cyclic Flexing (EIA-455-104)	2000 cycles, min.
Min. Bend Radius	
Installation	15 x OD
Long Term	10 x OD
Optical Specifications	See page 10.2

Fiber Bundle Detail

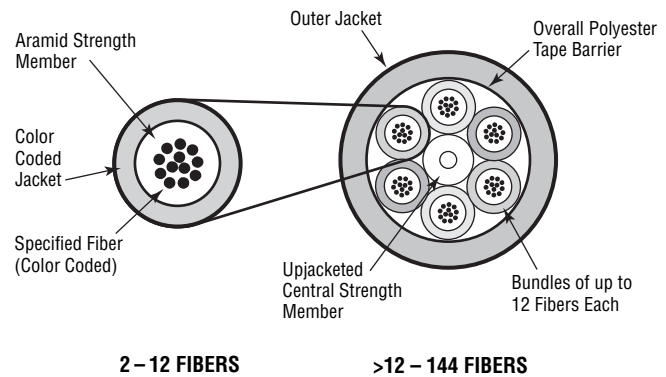

Distribution Cable

Tight Buffer — Indoor Riser, Plenum & LSZH Rated *(continued)*

No. of Fibers	Belden Part Number				Outside Diameter		Weight		Max. Install Load	
	62.5 / 125µm Std. / 1 Gbe	50 / 125µm Std. / 1 Gbe	50 / 125µm 10 Gbe – 300M	Single-mode Enhanced	Inch	mm	Lbs./1000'	kg/km	Lbs.	N

Distribution Cable Series

Riser (NEC/CEC OFNR/OFN FT4)

2	M9B037	M9A037	M9C037	M9W037	0.184	4.67	13	19	180	801
4	M9B038	M9A038	M9C038	M9W038	0.200	5.08	16	24	195	867
6	M9B039	M9A039	M9C039	M9W039	0.220	5.59	19	28	270	1201
8	M9B040	M9A040	M9C040	M9W040	0.235	5.97	22	33	270	1201
12	M9B042	M9A042	M9C042	M9W042	0.255	6.48	27	40	300	1334
24	M9B601*	M9A601*	M9C601*	M9W601*	0.325	8.26	42	63	390	1735
24	M9B602	M9A602	M9C602	M9W602	0.496	12.60	83	124	960	4270
36	M9B604	M9A604	M9C604	M9W604	0.644	16.36	137	204	1440	6405
48	M9B606	M9A606	M9C606	M9W606	0.627	15.93	131	195	945	4203
72	M9B609	M9A609	M9C609	M9W609	0.750	19.10	195	290	1350	6005
96	M9B622	M9A622	M9C622	M9W622	0.895	22.70	290	432	1983	8820
144	M9B619	M9A619	M9C619	M9W619	0.964	24.49	314	467	2745	12210

Composite Riser Cables

6xSM/12x62.5	M96992
12xSM/12x62.5	M96963
6xSM/12x50	M96909
12xSM/12x50	M96908

Plenum (NEC/CEC OFNP/OFN FT6)

2	M9B043	M9A043	M9C043	M9W043	0.184	4.67	14	21	180	801
4	M9B044	M9A044	M9C044	M9W044	0.174	4.42	13	19	195	867
6	M9B045	M9A045	M9C045	M9W045	0.190	4.83	16	24	270	1201
8	M9B046	M9A046	M9C046	M9W046	0.222	5.64	19	28	270	1201
12	M9B048	M9A048	M9C048	M9W048	0.225	5.72	22	33	300	1334
24	M9B611*	M9A611*	M9C611*	M9W611*	0.330	8.38	40	60	390	1735
24	M9B612	M9A612	M9C612	M9W612	0.493	12.52	89	132	1263	5618
36	M9B614	M9A614	M9C614	M9W614	0.594	15.09	134	199	1913	8509
48	M9B616	M9A616	M9C616	M9W616	0.599	15.21	131	195	1245	5538
72	M9B620	M9A620	M9C620	M9W620	0.754	19.15	197	293	2093	9310
96	M9B623	M9A623	M9C623	M9W623	0.904	22.96	268	399	2160	9608
144	M9B621	M9A621	M9C621	M9W621	1.047	26.59	365	543	3645	16213

Composite Plenum Cables

6xSM/6x62.5	M97174
6xSM/12x62.5	M97041
12xSM/12x62.5	M97219
6xSM/6x50	M97412
6xSM/12x50	M97411
12xSM/12x50	M96780

LSZH (NEC/CEC OFNR/OFN FT4)

2	M9B100	M9A100	M9C100	M9W100	0.184	4.67	15	22	180	800
4	M9B101	M9A101	M9C101	M9W101	0.200	5.08	17	25	195	867
6	M9B102	M9A102	M9C102	M9W102	0.220	5.59	21	31	270	1201
8	M9B103	M9A103	M9C103	M9W103	0.235	5.97	24	36	270	1201
12	M9B104	M9A104	M9C104	M9W104	0.255	6.48	29	43	300	1334
16	M9B105	M9A105	M9C105	M9W105	0.347	8.80	43	63	315	1400
24	M9B107	M9A107	M9C107	M9W107	0.386	9.80	54	79	450	2000
36	M9B111	M9A111	M9C111	M9W111	0.798	20.00	214	313	1619	7200
48	M9B112	M9A112	M9C112	M9W112	0.835	21.20	237	347	1619	7200
72	M9B114	M9A114	M9C114	M9W114	0.883	22.40	270	395	1619	7200
96	M9B116	M9A116	M9C116	M9W116	0.973	24.70	364	532	1619	7200
144	M9B120	M9A120	M9C120	M9W120	1.087	27.60	384	561	1619	7200

Construction for LSZH cables differs from the drawing. Alternative fiber counts are available.

*Single jacket design.



Breakout Style Cable

Tight Buffer — Indoor Riser, Plenum & LSZH Rated

Applications

- Low to medium fiber count requirements
- In-building backbone or horizontal deployment
- Office wiring
- Factory floor automation and harsh environment installations

Product Description

Full dielectric construction, no grounding required. Available with 2 to 36 fibers. Fiber subunits are color coded for easy identification. Length markings in meters for easy determination of cable length. For Riser offering, MSHA approved cables are available.

Outer Jacket Material	
Riser & Plenum	PVC
Plenum	PVDF
Low Smoke Zero Halogen	LSZH
Sub-unit Jacket Material	
Riser & Plenum	PVC
Low Smoke Zero Halogen	LSZH
Tight Buffer	
Riser & Plenum	PVC
Low Smoke Zero Halogen	LSZH
Strength Member	
	Aramid Yarn
Color Code (Tight Buffer)	
	Per EIA/TIA 598-A, see page 10.2
Jacket Color	
Single-mode	Yellow
62.5/125 μm	Orange (Green for LSZH only)
50/125 μm / 1 Gbe	Orange
50/125 μm / 10 Gbe	Aqua

Ratings

Riser	
UL Type	OFNR
cUL Type	OFN FT4
Flame Resistance	UL 1666
Plenum	
UL Type	OFNP
cUL Type	OFN FT6
Flame Resistance	NFPA 262
Low Smoke Zero Halogen	
UL Type	OFNR
cUL Type	OFN FT4
Flame Resistance	UL 1666

Specifications

Temperature Range	
Storage	-40 to +80°C
Operating	-20 to +70°C
Crush Resistance (EIA-455-41)	2000 N/cm
Impact Resistance (EIA-455-25)	2000 Impacts @ 1.6 N-m
Cyclic Flexing (EIA-455-104)	2000 cycles, min.
Min. Bend Radius	
Installation	15 x OD
Long Term	10 x OD
Optical Specifications	See page 10.2

Fiber Bundle Detail

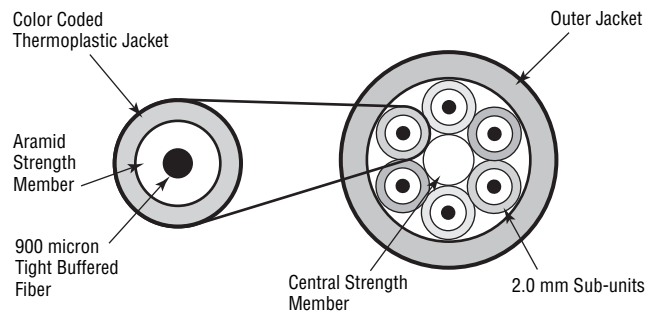

Breakout Style Cable

Tight Buffer — Indoor Riser, Plenum & LSZH Rated *(continued)*

No. of Fibers	Belden Part Number				Outside Diameter		Weight		Max. Install Load	
	62.5 / 125µm Std. / 1 Gbe	50 / 125µm Std. / 1 Gbe	50 / 125µm 10 Gbe – 300M	Single-mode Enhanced	Inch	mm	Lbs./1000'	kg/km	Lbs.	N
Breakout Cable Series										
Riser (NEC/CEC OFNR/OFN FT4)										
2	M9B005	M9A005	M9C005	M9W005	0.260	6.60	24	36	180	801
4	M9B006	M9A006	M9C006	M9W006	0.321	8.15	35	52	345	1535
6	M9B007	M9A007	M9C007	M9W007	0.358	9.09	54	80	543	2415
8	M9B008	M9A008	M9C008	M9W008	0.405	10.29	69	103	600	2700
10	M9B009	M9A009	M9C009	M9W009	0.455	11.56	86	128	600	2700
12	M9B010	M9A010	M9C010	M9W010	0.514	13.06	110	164	600	2700
18	M9B011	M9A011	M9C011	M9W011	0.520	13.21	104	155	600	2700
24	M9B012	M9A012	M9C012	M9W012	0.590	14.99	135	201	600	2700
36	M9B083	M9A083	M9C083	M9W083	0.680	17.27	168	250	600	2700
Plenum (NEC/CEC OFNP/OFN FT6)										
2	M9B013	M9A013	M9C013	M9W013	0.230	5.84	20	30	180	801
4	M9B014	M9A014	M9C014	M9W014	0.263	6.68	30	45	345	1535
6	M9B015	M9A015	M9C015	M9W015	0.309	7.85	41	61	465	2068
8	M9B016	M9A016	M9C016	M9W016	0.336	8.53	55	82	600	2700
10	M9B017	M9A017	M9C017	M9W017	0.385	9.78	73	109	600	2700
12	M9B018	M9A018	M9C018	M9W018	0.391	9.93	65	97	600	2700
18	M9B019	M9A019	M9C019	M9W019	0.456	11.58	89	132	600	2700
24	M9B020	M9A020	M9C020	M9W020	0.544	13.82	117	174	600	2700
36	M9B082	M9A082	M9C082	M9W082	0.612	15.54	154	229	600	2700
LSZH (NEC/CEC OFNR/OFN FT4)										
2	M9B130	M9A130	M9C130	M9W130	0.290	7.37	39	57	270	1200
4	M9B131	M9A131	M9C131	M9W131	0.351	8.92	38	55	285	1268
6	M9B132	M9A132	M9C132	M9W132	0.358	9.09	52	76	543	2415
8	M9B133	M9A133	M9C133	M9W133	0.405	10.29	67	98	600	2700
10	M9B134	M9A134	M9C134	M9W134	0.455	11.56	110	162	600	2700
12	M9B135	M9A135	M9C135	M9W135	0.514	13.06	110	161	600	2700
18	M9B136	M9A136	M9C136	M9W136	0.520	13.21	103	151	600	2700
24	M9B137	M9A137	M9C137	M9W137	0.590	14.99	138	202	600	2700
36	M9B138	M9A138	M9C138	M9W138	0.680	17.27	171	250	600	2700

2.5 mm Breakout Cables are also available.

Industrial Armored Cable

Tight Buffer — Riser & Plenum Rated

Applications

- Industrial environments
- Rugged installations
- Manufacturing plants
- Mining operations
- Telecommunications and data trunk
- Inter- and intra-building installations

Product Description

Heavy duty construction with interlocking aluminum armor (steel available on request) provides excellent mechanical protection from cutting or crushing and eliminates need for innerduct. Rodent resistant. Also available for outside plant. Loose tube design available on request.

Jacket Material	Riser & Plenum	PVC
Buffer Tube		PVC
Strength Member		Aramid Yarn
Central Strength Member		E-Glass
Armor		Aluminum
Color Code (Buffer)		Per EIA/TIA 598-A, see page 10.2
Jacket Color	Single-mode 62.5/125 μm 50/125 μm / 1 Gbe 50/125 μm / 10 Gbe	Yellow Orange Orange Aqua

Ratings

Riser	UL Type	OFRC
	cUL Type	OFC FT4
	Flame Resistance	UL 1666
Plenum	UL Type	OFCP
	cUL Type	OFC FT6
	Flame Resistance	NFPA 262

Specifications

Temperature Range	Storage	-40 to +70°C
	Operating	-20 to +70°C
Crush Resistance (EIA-455-41)		2000 N/cm
Impact Resistance (EIA-455-25)		2000 Impacts @ 3.0 N-m
Min. Bend Radius	Installation	20 x OD
	Long Term	15 x OD
Optical Specifications		See page 10.2

Fiber Bundle Detail

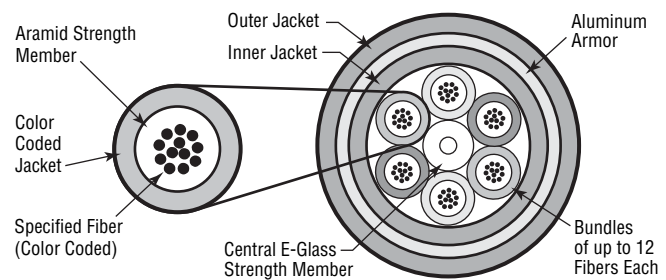

No. of Fibers	Belden Part Number				Outside Diameter		Weight		Max. Install Load	
	62.5 / 125μm Std. / 1 Gbe	50 / 125μm Std. / 1 Gbe	50 / 125μm 10 Gbe – 300M	Single-mode Enhanced	Inch	mm	Lbs./'1000'	kg/km	Lbs.	N

Industrial Armored Series

Riser (NEC/CEC OFCR/OFC FT4)										
6	M9B230	M9A230	M9C230	M9W230	0.570	14.50	126	188	270	1201
12	M9B231	M9A231	M9C231	M9W231	0.620	15.70	149	222	300	1334
24	M9B232*	M9A232*	M9C232*	M9W232*	0.670	17.00	179	266	390	1735
24	M9B233	M9A233	M9C233	M9W233	0.845	21.46	263	391	600	2700
36	M9B234	M9A234	M9C234	M9W234	0.970	24.64	368	548	600	2700
48	M9B235	M9A235	M9C235	M9W235	0.970	24.64	368	548	600	2700
72	M9B236	M9A236	M9C236	M9W236	1.095	27.82	481	716	600	2700
96	M9B237	M9A237	M9C237	M9W237	1.245	31.62	625	930	600	2700
144	M9B238	M9A238	M9C238	M9W238	1.320	33.55	675	1005	600	2700
Plenum (NEC/CEC OFCP/OFC FT6)										
6	M9B240	M9A240	M9C240	M9W240	0.471	12.00	87	129	270	1201
12	M9B241	M9A241	M9C241	M9W241	0.506	12.90	103	153	300	1334
24	M9B242*	M9A242*	M9C242*	M9W242*	0.631	16.00	151	225	390	1735
24	M9B243	M9A243	M9C243	M9W243	0.781	19.84	289	430	600	2700
36	M9B244	M9A244	M9C244	M9W244	0.881	22.38	309	460	600	2700
48	M9B245	M9A245	M9C245	M9W245	0.906	23.01	320	476	600	2700
72	M9B246	M9A246	M9C246	M9W246	1.056	26.82	451	671	600	2700
96	M9B247	M9A247	M9C247	M9W247	1.256	31.90	608	905	600	2700
144	M9B248	M9A248	M9C248	M9W248	1.331	33.81	687	1022	600	2700

*Single jacket design.

All optical fiber products can be supplied in compliance with RoHS regulations.



Tactical Cable

Tight Buffer — Outdoor

Applications

- ENG vehicles
- Outdoor news, sporting or other events
- Digital camera transmission
- Military communications
- Re-deployable communications

Product Description

Small and lightweight with a rugged jacket, Tactical Cable provides a durable design for repeated deployment and retrieval cycles and a superior level of crush resistance. Designed to military standards. 50/125 micron fiber available on request.

Jacket Material	UV-resistant PU
Buffer	Polyester
Strength Member	Aramid Yarn
Color Code (Jacket & Fibers)	Per EIA/TIA 598-A, see page 10.2

Specifications

Temperature Range	
Storage	-70 to +85°C
Operating	-55 to +85°C
Crush Resistance (EIA-455-41)	440 N/cm
Impact Resistance (EIA-455-25)	200 Impacts @ 2.2 N-m
Cyclic Flexing (EIA-455-104)	2000 cycles, min.
Min. Bend Radius	
Installation	15 x OD
Long Term	8 x OD
Optical Specifications	See page 10.2

Fiber Bundle Detail

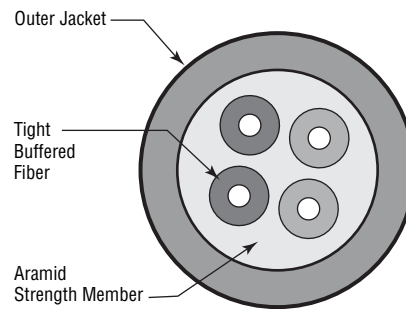

No. of Fibers	Belden Part Number		Outside Diameter		Weight		Max. Install Load	
	62.5 / 125µm Std. / 1 Gbe	Single-mode Enhanced	Inch	mm	Lbs./1000'	kg/km	Lbs.	N

Tactical Series

Outdoor								
2	M96571	M96566	0.217	5.5	19	28	330	1468
4	M96551	M96639	0.225	5.7	21	31	330	1468
6	M96572	M96567	0.236	6.0	23	34	330	1468
8	M96573	M96568	0.250	6.3	26	39	330	1468
10	M96574	M96569	0.265	6.7	28	42	330	1468
12	M96575	M96570	0.280	7.1	31	46	330	1468

Please contact the Technical Support Group for proper connectivity integration and installation guidance.

Ribbon Cable

Riser and Plenum Rated

Applications

- Inter-equipment connections
- NEBS applications

Product Description

Small size is ideal for connections in tight spaces. Color coded fibers. Suitable for use with standard ribbon connectors. Flexible, with half-inch minimum bend radius. Tight center-to-center tolerances. Optional identification printing available.

Jacket Material	PVC
Strength Member	Aramid Yarn
Color Code (Jacket & Fibers)	Per EIA/TIA 598-A, see page 10.2
Jacket Color	
Single-mode	Yellow
62.5/125µm	Orange
50/125 µm / 1 Gbe	Orange
50/125 µm / 10 Gbe	Aqua

Ratings

Riser	
UL Type	OFNR
cUL Type	OFN FT4
Flame Resistance	UL 1666
Plenum	
UL Type	OFNP
cUL Type	OFN FT6
Flame Resistance	NFPA 262

Specifications

Temperature Range	
Storage	-40 to +80°C
Operating	-20 to +70°C
Crush Resistance (EIA-455-41)	2000 N/cm
Impact Resistance (EIA-455-25)	2000 Impacts @ 1.6 N-m
Cyclic Flexing (EIA-455-104)	2000 cycles, min.
Min. Bend Radius	
Installation	15 x OD
Long Term	10 x OD
Optical Specifications	See page 10.2

Fiber Bundle Detail

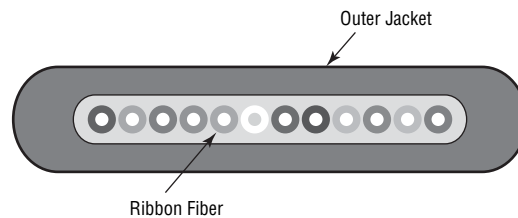

No. of Fibers	Belden Part Number				Outside Diameter		Weight		Max. Install Load	
	62.5 / 125µm Std. / 1 Gbe	50 / 125µm Std. / 1 Gbe	50 / 125µm 10 Gbe – 300M	Single-mode Enhanced	Inch	mm	Lbs./1000'	kg/km	Lbs.	N

Ribbon Series

Riser (NEC/CEC OFNR/OFN FT4)										
2	M9B630	M9A630	M9C630	M9W630	0.114	2.9	5	7	100	444
4	M9B631	M9A631	M9C631	M9W631	0.78 x 0.115	2.0 x 2.9	4	6	100	444
6	M9B632	M9A632	M9C632	M9W632	0.78 x 0.137	2.0 x 3.5	6	9	100	444
8	M9B633	M9A633	M9C633	M9W633	0.78 x 0.158	2.0 x 4.0	6	9	100	444
12	M9B634	M9A634	M9C634	M9W634	0.78 x 0.180	2.0 x 4.6	7	10	100	444
Plenum (NEC/CEC OFNP/OFN FT6)										
2	M9B640	M9A640	M9C640	M9W640	0.114	2.9	5	7	100	444
4	M9B641	M9A641	M9C641	M9W641	0.78 x 0.115	2.0 x 2.9	4	6	100	444
6	M9B642	M9A642	M9C642	M9W642	0.78 x 0.137	2.0 x 3.5	6	9	100	444
8	M9B643	M9A643	M9C643	M9W643	0.78 x 0.158	2.0 x 4.0	6	9	100	444
12	M9B644	M9A644	M9C644	M9W644	0.78 x 0.180	2.0 x 4.6	7	10	100	444

Fiber Ribbon Cable is to be sold as bulk cable and has not been qualified for field connectorization.

Single Jacket, All Dielectric Cable

Loose Tube — Outdoor, and Indoor/Outdoor Riser Rated

Applications

- Medium to high fiber count requirements
- Inter-building duct installations
- Lashed aerial
- Indoor/outdoor
- Industrial outside plant

Product Description

Gel-filled buffer tube prevents water migration. All-dielectric strength member. Available as Riser rated cable, thereby eliminating the need for service entrance splicing to in-building cable. Full dielectric construction, no grounding required. Available with up to 216 fibers. Length markings in meters for easy determination of cable length.

Jacket Material	
Outdoor	PE
Riser	PVC
Buffer Tube	PBT
Strength Member	Aramid Yarn
Central Strength Member	E-Glass
Color Code (Buffer)	Per EIA/TIA 598-A, see page 10.2
Jacket Color	Black

Ratings

Riser	
UL Type	OFNR
cUL Type	OFN FT4
Flame Resistance	UL 1666

Specifications

Temperature Range (Outdoor Series)	
Storage	-50 to +80°C
Operating	-40 to +70°C
Temperature Range (Riser Series)	
Storage	-40 to +80°C
Operating	-40 to +70°C
Crush Resistance (EIA-455-41)	2000 N/cm
Impact Resistance (EIA-455-25)	2000 Impacts @ 1.6 N-m
Min. Bend Radius	
Installation	20 x OD
Long Term	15 x OD
Optical Specifications	See page 10.2

Fiber Bundle Detail

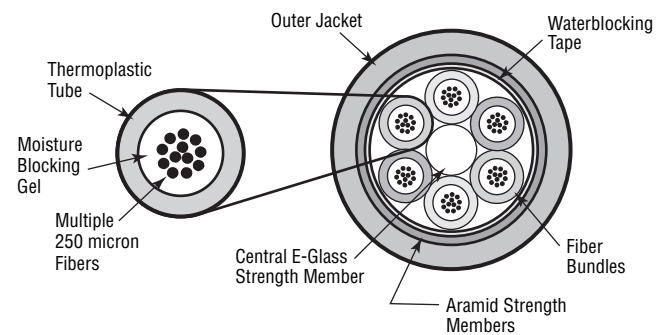

No. of Fibers	Fibers Per Tube	Belden Part Number				Outside Diameter		Weight		Max. Install Load	
		62.5 / 125µm Std. / 1 Gbe	50 / 125µm Std. / 1 Gbe	50 / 125µm 10 Gbe – 300M	Single-mode Enhanced	Inch	mm	Lbs./1000'	kg/km	Lbs.	N

Loose Tube Series

Outdoor											
6	6	M9B510T	M9A510T	M9C510T	M9W510T	0.38	9.65	44	65	600	2700
12	6	M9B511T	M9A511T	M9C511T	M9W511T	0.38	9.65	44	65	600	2700
24	6	M9B500T	M9A500T	M9C500T	M9W500T	0.38	9.65	45	67	600	2700
36	6	M9B502T	M9A502T	M9C502T	M9W502T	0.38	9.65	47	70	600	2700
48	12	M9B505T	M9A505T	M9C505T	M9W505T	0.48	12.19	70	104	600	2700
72	12	M9B507T	M9A507T	M9C507T	M9W507T	0.48	12.19	70	104	600	2700
96	12	M9B513T	M9A513T	M9C513T	M9W513T	0.55	13.89	93	138	600	2700
144	12	M9B509T	M9A509T	M9C509T	M9W509T	0.70	17.78	149	222	600	2700
216	12	M9B520T	M9A520T	M9C520T	M9W520T	0.72	18.16	148	220	600	2700
Riser (NEC/CEC OFNR/OFN FT4)											
6	6	M9B810	M9A810	M9C810	M9W810	0.38	9.65	63	94	600	2700
12	6	M9B811	M9A811	M9C811	M9W811	0.38	9.65	62	92	600	2700
24	6	M9B812	M9A812	M9C812	M9W812	0.38	9.65	61	91	600	2700
36	6	M9B813	M9A813	M9C813	M9W813	0.38	9.65	60	89	600	2700
48	12	M9B814	M9A814	M9C814	M9W814	0.48	12.19	89	132	600	2700
72	12	M9B815	M9A815	M9C815	M9W815	0.48	12.19	87	129	600	2700
96	12	M9B816	M9A816	M9C816	M9W816	0.55	13.89	114	170	600	2700
144	12	M9B817	M9A817	M9C817	M9W817	0.70	17.78	187	278	600	2700

Alternative fiber counts are available.



Single Jacket, All Dielectric Cable

Loose Tube — Indoor/Outdoor Plenum Rated

Applications

- Medium to high fiber count requirements
- Inter-building duct installations
- Lashed aerial
- Indoor/outdoor
- Campus backbones
- Data Centers
- High Density Cable Trays

Product Description

Dry waterblocking technology used within tubes and under jacket. Available as Plenum rated cable, thereby eliminating the need for service entrance splicing to in-building cable. Small diameter and bend radius facilitate installation in tight spaces. Full dielectric construction, no grounding required. Available with up to 144 fibers. Fibers grouped into sets of 12 for maximum density. Length markings in meters for easy determination of cable length.

Jacket Material	Non-unitized Unitized	PVC PVDF
Buffer Tube		PVC
Strength Member		E-Glass and Aramid Yarn
Central Strength Member		Upjacketed
Color Code (Buffer)		Per EIA/TIA 598-A, see page 10.2
Jacket Color		Black

Ratings

Plenum	
UL Type	OFNP
cUL Type	OFN FT6
Flame Resistance	NFPA 262

Specifications

Temperature Range	
Storage	-40 to +80°C
Operating	-40 to +70°C
Installation	0 to +60°C
Crush Resistance (EIA-455-41)	2000 N/cm
Impact Resistance (EIA-455-25)	2000 Impacts @ 1.6 N-m
Cyclic Flexing (EIA-455-104)	2000 cycles, min.
Min. Bend Radius	
Installation	20 x OD
Long Term	15 x OD
Optical Specifications	See page 10.2

Fiber Bundle Detail

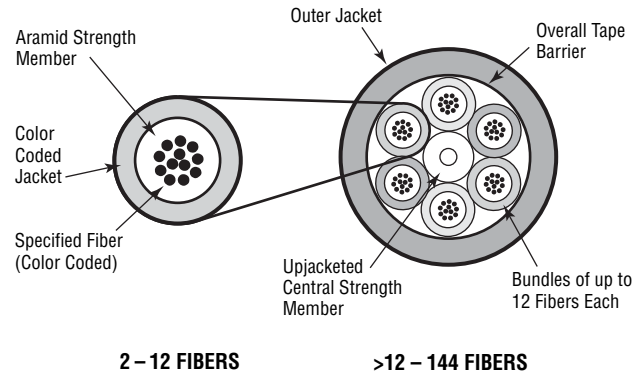

No. of Fibers	Fibers Per Tube	Belden Part Number				Outside Diameter		Weight		Max. Install Load	
		62.5 / 125µm Std. / 1 Gbe	50 / 125µm Std. / 1 Gbe	50 / 125µm 10 Gbe - 300M	Single-mode Enhanced	Inch	mm	Lbs./1000'	kg/km	Lbs.	N

Loose Tube Series

Plenum (NEC/CEC OFNP/OFN FT6)											
6	6	M9B202	M9A202	M9C202	M9W202	0.265	6.70	33	49	320	1423
12	12	M9B204	M9A204	M9C204	M9W204	0.265	6.70	33	49	320	1423
24	12	M9B205	M9A205	M9C205	M9W205	0.359	9.12	47	70	405	1801
36	12	M9B206	M9A206	M9C206	M9W206	0.359	9.12	47	70	405	1801
48	12	M9B207	M9A207	M9C207	M9W207	0.359	9.12	48	71	405	1801
72	12	M9B209	M9A209	M9C209	M9W209	0.429	10.90	71	106	585	2602
96	12	M9B211	M9A211	M9C211	M9W211	0.501	12.73	105	156	903	4017
144	12	M9B215	M9A215	M9C215	M9W215	0.665	16.89	189	281	1263	5618

Alternative fiber counts and hybrid constructions are available.

Double Jacket, Armored Cable

Loose Tube – Outdoor, and Indoor/Outdoor Riser Rated

Applications

- Direct burial
- Low to high fiber count requirements
- Inter-building duct installations
- Indoor/outdoor
- Industrial outside plant

Product Description

Gel-filled buffer tube prevents water migration. Available as Riser rated cable, thereby eliminating the need for service entrance splicing to in-building cable. Rodent resistant. Available in sizes up to 216 fibers. Length markings in meters for easy determination of cable length.

Jacket Material	
Outdoor	PE
Riser	PVC
Buffer Tube	
Outdoor	PBT
Riser	PVC
Strength Member	
	Aramid Yarn
Central Strength Member	
	E-Glass
Armor	
	Corrugated Steel Tape
Color Code (Buffer)	
	Per EIA/TIA 598-A, see page 10.2
Jacket Color	
	Black

Ratings

Riser	
UL Type	OFCR
cUL Type	OFC FT4
Flame Resistance	UL 1666

Specifications

Temperature Range (Outdoor)	
Storage	-50 to +80°C
Operating	-40 to +70°C
Temperature Range (Riser)	
Storage	-40 to +80°C
Operating	-40 to +70°C
Crush Resistance (EIA-455-41)	2000 N/cm
Impact Resistance (EIA-455-25)	2000 Impacts @ 1.6 N-m
Min. Bend Radius	
Installation	20 x OD
Long Term	15 x OD
Optical Specifications	See page 10.2

Fiber Bundle Detail

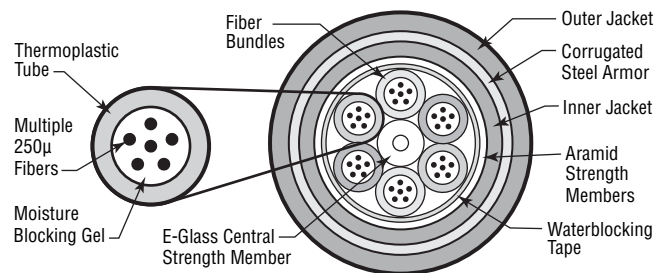

No. of Fibers	Fibers Per Tube	Belden Part Number				Outside Diameter		Weight		Max. Install Load	
		62.5 / 125µm Std. / 1 Gbe	50 / 125µm Std. / 1 Gbe	50 / 125µm 10 Gbe – 300M	Single-mode Enhanced	Inch	mm	Lbs./1000'	kg/km	Lbs.	N

Loose Tube Series — Armored

Outdoor											
6	6	M9B381T	M9A381T	M9C381T	M9W381T	0.53	13.46	101	150	600	2700
12	6	M9B382T	M9A382T	M9C382T	M9W382T	0.53	13.46	102	152	600	2700
24	6	M9B384T	M9A384T	M9C384T	M9W384T	0.53	13.46	103	153	600	2700
36	6	M9B386T	M9A386T	M9C386T	M9W386T	0.53	13.46	103	153	600	2700
48	12	M9B389T	M9A389T	M9C389T	M9W389T	0.65	16.51	144	214	600	2700
72	12	M9B391T	M9A391T	M9C391T	M9W391T	0.65	16.51	142	211	600	2700
96	12	M9B398T	M9A398T	M9C398T	M9W398T	0.69	17.53	168	250	600	2700
144	12	M9B393T	M9A393T	M9C393T	M9W393T	0.87	22.10	241	359	600	2700
216	12	M9B400T	M9A400T	M9C400T	M9W400T	0.87	22.10	241	359	600	2700
Riser (NEC/CEC OFCR/OFC FT4)											
6	6	M9B890	M9A890	M9C890	M9W890	0.54	13.72	138	205	600	2700
12	6	M9B891	M9A891	M9C891	M9W891	0.54	13.72	137	204	600	2700
24	6	M9B892	M9A892	M9C892	M9W892	0.54	13.72	136	202	600	2700
36	6	M9B893	M9A893	M9C893	M9W893	0.54	13.72	135	201	600	2700
48	12	M9B894	M9A894	M9C894	M9W894	0.66	16.76	176	262	600	2700
72	12	M9B895	M9A895	M9C895	M9W895	0.66	16.76	172	256	600	2700
96	12	M9B896	M9A896	M9C896	M9W896	0.70	17.78	206	307	600	2700
144	12	M9B897	M9A897	M9C897	M9W897	0.88	22.35	302	449	600	2700



Double Jacket, Heavy-Duty Cable

Loose Tube — Outdoor

Applications

- Direct burial
- Harsh environments
- Applications requiring good ozone-, moisture- and weather-resistance

Product Description

Gel-filled buffer tube prevents water migration. Available with up to 216 fibers.

Jacket Material	
Outer Jacket:	PE
Inner Jacket:	PE
Buffer Tube	
	PBT
Strength Member	
	Aramid Yarn
Central Strength Member	
	E-Glass
Core Wrap	
	Water Swellable Tape
Color Code (Buffer)	
	Per EIA/TIA 598-A, see page 10.2
Jacket Color	
	Black

Specifications

Temperature Range	
Storage	-50 to +80°C
Operating	-40 to +70°C
Crush Resistance (EIA-455-41)	
	2000 N/cm
Impact Resistance (EIA-455-25)	
	2000 Impacts @ 1.6 N-m
Min. Bend Radius	
Installation	20 x OD
Long Term	15 x OD
Optical Specifications	
	See page 10.2

Fiber Bundle Detail

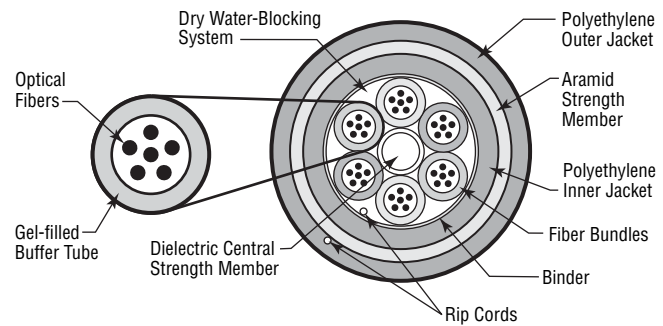

No. of Fibers	Fibers Per Tube	Belden Part Number				Outside Diameter		Weight		Max. Install Load	
		62.5 / 125µm Std. / 1 Gbe	50 / 125µm Std. / 1 Gbe	50 / 125µm 10 Gbe – 300M	Single-mode Enhanced	Inch	mm	Lbs./1000'	kg/km	Lbs.	N

Loose Tube Series — Heavy Duty

Outdoor											
2	2	M9B840	M9A840	M9C840	M9W840	0.44	11.18	60	89	600	2700
4	4	M9B841	M9A841	M9C841	M9W841	0.44	11.18	60	89	600	2700
6	6	M9B842	M9A842	M9C842	M9W842	0.44	11.18	60	89	600	2700
8	4	M9B843	M9A843	M9C843	M9W843	0.44	11.18	60	89	600	2700
12	6	M9B844	M9A844	M9C844	M9W844	0.44	11.18	60	89	600	2700
18	6	M9B845	M9A845	M9C845	M9W845	0.44	11.18	60	89	600	2700
24	6	M9B846	M9A846	M9C846	M9W846	0.44	11.18	60	89	600	2700
36	6	M9B847	M9A847	M9C847	M9W847	0.44	11.18	60	89	600	2700
48	12	M9B848	M9A848	M9C848	M9W848	0.54	13.72	136	202	600	2700
72	12	M9B849	M9A849	M9C849	M9W849	0.54	13.72	136	202	600	2700
96	12	M9B820	M9A820	M9C820	M9W820	0.61	15.37	152	226	600	2700
144	12	M9B821	M9A821	M9C821	M9W821	0.76	19.30	255	379	600	2700
216	12	M9B822	M9A822	M9C822	M9W822	0.76	19.30	255	379	600	2700

Central Tube Cable

Loose Tube—Outdoor, and Outdoor Armored

Applications

- Campus OSP backbones
- Drop cable
- Telecommunications and data trunk
- Direct burial (armored only)
- Lashed aerial

Product Description

Economical option for low fiber counts. Quick and easy end preparation. Fully waterblocked with gel-filled buffer tube. No rods – easy handling. Crush, impact and abrasion resistant.

Jacket Material	PE
Buffer Tube	PBT
Core Wrap	Water Swellable Tape
Strength Member	Fiberglass
Armor	Corrugated Steel
Color Codes (Jacket & Fibers)	Per EIA/TIA 598-A, see page 10.2
Jacket Color	Black

Specifications

Temperature Range	
Storage	-40 to +70°C
Operating	-40 to +70°C
Crush Resistance (EIA-455-41)	2000 N/cm
Impact Resistance (EIA-455-25)	2000 Impacts @ 1.6 N-m
Min. Bend Radius	
Installation	20 x OD
Long Term	15 x OD
Optical Specifications	See page 10.2

Fiber Bundle Detail

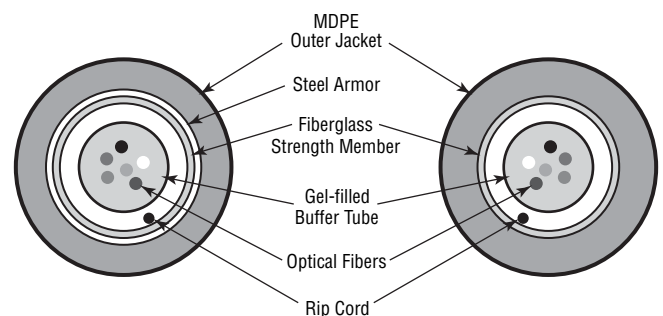

SINGLE ARMOR

ALL DIELECTRIC

No. of Fibers	Belden Part Number				Outside Diameter		Weight		Max. Install Load	
	62.5 / 125µm Std. / 1 Gbe	50 / 125µm Std. / 1 Gbe	50 / 125µm 10 Gbe – 300M	Single-mode Enhanced	Inch	mm	Lbs./1000'	kg/km	Lbs.	N

Central Tube Series

Outdoor										
2	M9B150	M9A150	M9C150	M9W150	0.325	8.26	36	54	600	2700
4	M9B151	M9A151	M9C151	M9W151	0.325	8.26	36	54	600	2700
6	M9B152	M9A152	M9C152	M9W152	0.325	8.26	36	54	600	2700
8	M9B153	M9A153	M9C153	M9W153	0.325	8.26	36	54	600	2700
10	M9B154	M9A154	M9C154	M9W154	0.325	8.26	36	54	600	2700
12	M9B155	M9A155	M9C155	M9W155	0.325	8.26	36	54	600	2700
Outdoor Armored										
2	M9B170	M9A170	M9C170	M9W170	0.410	10.41	72	108	600	2700
4	M9B171	M9A171	M9C171	M9W171	0.410	10.41	72	108	600	2700
6	M9B172	M9A172	M9C172	M9W172	0.410	10.41	72	108	600	2700
8	M9B173	M9A173	M9C173	M9W173	0.410	10.41	72	108	600	2700
10	M9B174	M9A174	M9C174	M9W174	0.410	10.41	72	108	600	2700
12	M9B175	M9A175	M9C175	M9W175	0.410	10.41	72	108	600	2700

All optical fiber products can be supplied in compliance with RoHS regulations. Please contact Customer Service for more details.

Micro Loose Tube Breakout Style Cable

Loose Tube – Outdoor, Indoor/Outdoor OFN & Indoor/Outdoor Riser Rated

Applications

- Ducts between buildings (above or below frost lines)
- Lashed aerial
- Telecommunications and data trunk

Product Description

Easy handling and termination of a breakout style cable. Loose buffer dimensions compatible with standard connectors (900 µm). Waterblocking gel for moisture protection. Breakout kits not required for connectorization.

Jacket Material	
Outdoor	PE
Riser	PVC
General Purpose	TPE
Buffer tube	
Outdoor + Riser	PBT
Strength Elements	Aramid Yarn
Strength Member(s)	Upjacketed Aramid
Color Codes (Jacket & Fibers)	Per EIA/TIA 598-A, see page 10.2
Jacket Color	Black

Ratings

Riser	
UL Type	OFNR
cUL Type	OFN FT4
Flame Resistance	UL 1666
General Purpose	
UL/cUL Type	OFN
Flame Resistance	UL 1581

Specifications

Temperature Range	
Storage	-40 to +70°C
Operating	-20 to +70°C
Crush Resistance (EIA-455-41)	600 N/cm
Impact Resistance (EIA-455-25)	20 Impacts @ 1.0 N-m
Min. Bend Radius	
Installation	20 x OD
Long Term	15 x OD
Optical Specifications	See page 10.2

Fiber Bundle Detail

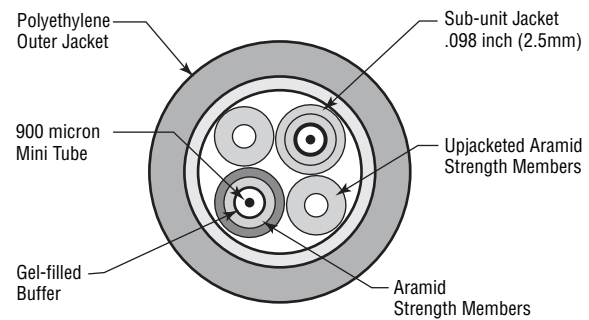

Micro Loose Tube Breakout Style CableLoose Tube – Outdoor, Indoor/Outdoor OFN & Indoor/Outdoor Riser Rated (*continued*)

No. of Fibers	Belden Part Number				Outside Diameter		Weight		Max. Install Load	
	62.5 / 125µm Std. / 1 Gbe	50 / 125µm Std. / 1 Gbe	50 / 125µm 10 Gbe – 300M	Single-mode Enhanced	Inch	mm	Lbs./1000'	kg/km	Lbs.	N
Micro Loose Tube Series										
Outdoor										
1	M9B700	M9A700	M9C700	M9W700	0.340	8.64	41	61	330	1468
2	M9B701	M9A701	M9C701	M9W701	0.360	9.14	41	61	345	1535
4	M9B702	M9A702	M9C702	M9W702	0.360	9.14	39	58	285	1267
6	M9B703	M9A703	M9C703	M9W703	0.418	10.62	54	80	405	1801
8	M9B704	M9A704	M9C704	M9W704	0.478	12.14	76	113	600	2700
12	M9B705	M9A705	M9C705	M9W705	0.614	15.60	129	192	600	2700
Indoor/Outdoor OFN										
1	M9B720	M9A720	M9C720	M9W720	0.344	8.74	50	74	330	1468
2	M9B721	M9A721	M9C721	M9W721	0.364	9.25	51	76	345	1535
4	M9B722	M9A722	M9C722	M9W722	0.364	9.25	49	73	285	1267
6	M9B723	M9A723	M9C723	M9W723	0.424	10.72	68	101	405	1801
8	M9B724	M9A724	M9C724	M9W724	0.482	12.24	77	115	600	2700
12	M9B725	M9A725	M9C725	M9W725	0.618	15.70	130	193	600	2700
Indoor/Outdoor Riser										
1	M9B740	M9A740	M9C740	M9W740	0.352	8.94	54	80	330	1468
2	M9B741	M9A741	M9C741	M9W741	0.372	9.45	55	82	345	1535
4	M9B742	M9A742	M9C742	M9W742	0.372	9.45	51	76	285	1267
6	M9B743	M9A743	M9C743	M9W743	0.432	10.97	74	110	405	1801
8	M9B744	M9A744	M9C744	M9W744	0.490	12.45	94	140	600	2700
12	M9B745	M9A745	M9C745	M9W745	0.626	15.90	151	229	600	2700

Please contact the Technical Support Group for proper connectivity integration and installation guidance.

TrayOptic® Heavy-Duty, All Dielectric Cable

Loose Tube — Indoor/Outdoor Riser Rated

Applications

- Industrial and other harsh environment applications
- Factory automation
- Direct burial

Product Description

Laser Optimized Fiber to handle Gigabit Ethernet light sources and expanded bandwidth requirements. Passes IEEE 383-2003 flame test. Waterblocking agent for moisture protection. CPE outer jacket option provides extra chemical or abrasion resistance.

Fiber Type	62.5/125μ
Jacket Material	PVC or CPE
Strength Member	Aramid Yarn
Jacket Color	Orange

Ratings

Riser	
UL Type	OFNR
cUL Type	OFN FT4
Flame Resistance	IEEE 383-2003

Specifications

Temperature Range	
Storage	-40 to +70°C
Operating	-40 to +70°C
Crush Resistance (EIA-455-41)	2000 N/cm
Impact Resistance (EIA-455-25)	2000 impacts @ 1.6N-m
Cyclic Flexing (EIA-455-104)	25 cycles, 12 lbs., 20 x OD radius min.
Min. Bend Radius	
Installation	20 x OD
Long Term	15 x OD
Maximum Installation Load	600 lbs. (2700 N)
Optical Specifications	See page 10.2

Fiber Bundle Detail

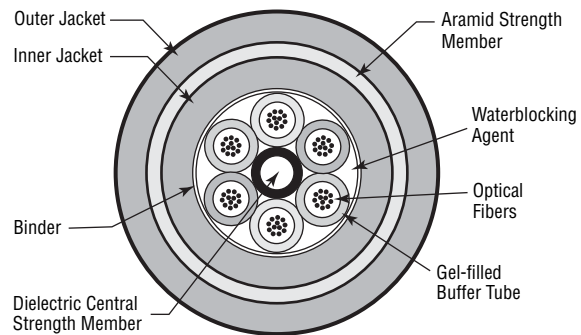

No. of Fibers	Fibers Per Tube	Outside Diameter		PVC Jacket			CPE Jacket		
		Inches	mm	Belden Part No.	Weight Lbs./1000'	Weight kg/km	Belden Part No.	Weight Lbs./1000'	Weight kg/km

TrayOptic Series

Riser (NEC/CEC OFNR/OFN FT4)									
2	2	0.440	11.18	I100255	88	131	I100266	83	124
4	4	0.440	11.18	I100455	88	131	I100466	83	124
6	6	0.440	11.18	I100655	88	131	I100666	83	124
8	4	0.440	11.18	I400855	88	131	I400866	83	124
12	6	0.440	11.18	I601255	88	131	I601266	83	124
18	6	0.440	11.18	I601855	88	131	I601866	83	124
24	6	0.440	11.18	I602455	88	131	I602466	83	124
36	6	0.440	11.18	I603655	88	131	I603666	83	124
48	12	0.540	13.72	I604855	136	202	I604866	129	192
60	12	0.540	13.72	I606055	136	202	I606066	129	192
72	12	0.540	13.72	I607255	136	202	I607266	129	192



Commercial Networking: Training

Table of Contents

Commercial Networking — Training	Page No.
Overview: Belden IBDN Training	17.2
Course Descriptions / Course Number	17.3–17.6
Intro to Belden Belden IBDN 305	17.3
Project Management Belden IBDN 201/202	17.3
Design and Concept Belden IBDN 303	17.4
Installation Belden IBDN 700	17.4
Copper Products Belden IBDN 726	17.5
Optical Fiber Products Belden IBDN 746	17.5
End-to-End Installation/Testing – Copper Belden IBDN 727	17.6
End-to-End Installation/Testing – Optical Fiber Belden IBDN 747	17.6

Belden IBDN Training

Overview



Ensuring Competency Worldwide

The Belden IBDN Training Center has been an integral part of the structured cabling industry landscape for over 14 years, having earned an international reputation for delivering the industry's most comprehensive and effective structured cabling training.

This reputation is forged on the experiences of more than 65,000 students trained worldwide since 1991. Today, the Belden IBDN Training Center serves the needs of more than 5,000 students each year. Our goal is to provide our students with the skills and knowledge necessary to ensure the highest quality and optimal performance in every Belden IBDN System that they design and install.

Ensuring competency and understanding of new technologies, techniques and industry standards is a key goal in our course development. Each Belden IBDN Training Course is regularly updated to include the most current information on Belden IBDN products and practices, as well as new developments in cabling industry standards.

Learn from the Experts

Belden IBDN instructors have combined experience of well over 100 years in the planning, design and installation of structured cabling systems. In addition to real life experiences, most are BICSI™ accredited RCDD and RCDD/LAN Specialists, and many have additional technical credentials from industry leaders such as Microsoft™ and Cisco Systems™. Many of them have taught Belden IBDN courses all around the world, and all have the industry knowledge and professional teaching style that maximizes the learning experience.

The Purpose of the Belden IBDN Training Center

To ensure solid and optimal network performance, a cabling system supplier should be evaluated on the following criteria:

- Credibility and Industry Standing
- System Offerings
- Customer Care
- Business Partners
- Warranty Program

Through the Belden IBDN Training Center, Belden ensures that our students and Business Partners consistently and accurately represent Belden IBDN Systems, products, and installation standards, with the goal of optimizing network performance.

For More Information And Registration

For information on course dates, locations and fees, please refer to:

www.BeldenIBDN.com

Or contact us at the Belden IBDN Training Center:

IBDN.training@belden.com

1-800-262-9334

Belden IBDN Training

Course Descriptions

General Course Information

- Our courses are recognized by BICSI and earn BICSI Continuing Education Credits (CECs).
- Our courses qualify students by giving them a professional recognition that may accelerate their career advancement.
- In addition to the cabling contractor community, our courses are recognized and valued by end-customers, architects, engineers and consultants as well. If you need to increase your knowledge of structured cabling systems, the Belden IBDN Training Center is an excellent training investment.
- Our course content is offered in many different languages including English, French, Japanese, Spanish, Mandarin and Cantonese.
- Refresher courses for pre-qualified students are also available.
- Special rates and group discounts are available.
- Fees include a Certificate of Completion for selected courses, continental breakfast, coffee breaks and course materials.



Belden IBDN 305

Introduction to Belden

(By correspondence on CD Rom)

Who Should Attend:

End-users, Networking and Structured Cabling Sales People

Course Benefits:

Provides students with an overview of Belden as a leader in telecommunications and offers an overall picture of the Belden IBDN Systems and products, as well as the positioning of Belden in the industry.

What Will Be Covered:

- Introduction to cabling
- Overview of Belden IBDN Systems and products, including:
 - GigaFlex Cables: 1200, 2400, 4800LX,
 - Bonded-Pair Cables: DataTwist 350, MediaTwist, DataTwist 600e,
 - GigaBIX, FiberExpress, IntelliMAC-Plus, PowerSense and 10GX Solutions.
- Certification and Exercises
- Case Studies
- Reference Materials

Prerequisite: None

Written Exam: Yes

BICSI CECs: RCDD (7),
INS, Level 2/Technician (7)

Belden IBDN 201/202

Project Management for Belden IBDN including Belden IBDN System Audit

(2 days)

Who Should Attend:

Installation Managers,
Installation Supervisors

Participant must be familiar with Belden IBDN Systems as well as the Certification Program

Course Benefits:

Develop the skills to recognize the scale of the project and therefore be prepared to put an efficient work plan in place in order to deliver the project on time.

Gain an understanding of the Belden IBDN System design and installation requirements as related to the Belden IBDN Certification Program.

Learn how to conduct and write audit reports.

What Will Be Covered:

- Project Manager Responsibilities
- Project Planning
- Project Execution
- Project Closing
- When, Why and How audits are conducted
- Audit Preparation
- Audit Visit
- Audit Report

Prerequisites: Belden IBDN-303* and Belden IBDN-700*

*Taken after January 2001

Written Exam: Yes, two

BICSI CECs: RCDD (14),
RCDD/LAN (14),
INS, Level 2/Technician (12),
OSP (14),
RES (12)

Belden IBDN Training

Course Descriptions

Belden IBDN 303

Belden IBDN Design and Concept

(2 days) — Can also be provided by correspondence on CD Rom

Who Should Attend:

Architects, Designers,
Networking Consultants

Course Benefits:

Gain the ability to design a Belden IBDN Structured Cabling System.

Learn about standards and planning procedures related to the installation of structured cabling systems.

What Will Be Covered:

- Belden IBDN Systems and products:
 - GigaFlex Cable: 1200, 2400, 4800LX,
 - Bonded-Pair Cable: DataTwist 350, MediaTwist, DataTwist 600e,
 - GigaBIX, FiberExpress, IntelliMAC-Plus, PowerSense and 10GX Solutions
- Structured Cabling Overview
- Standards Update
- Horizontal Distribution Standards
- Backbone Distribution Standards
- Entrance Facility
- Bonding and Grounding
- Reference Materials
- 60% In-Class Exercises

Prerequisite: None

Written Exam: Yes

BICSI CECs: RCDD (14),
INS, Level 2/Technician (14)

Belden IBDN 700

Belden IBDN Installation

(2 days)

Who Should Attend:

Belden Certified System Vendor (CSV)
Installers, and Distributors

Course Benefits:

Develop a fundamental understanding of a Belden IBDN Structured Cabling System.

Gain valuable experience on how to install and maintain a complete Belden IBDN Structured Cabling System.

What Will Be Covered:

- Belden Company Overview
- Structured Cabling History
- Standards Overview
- Belden IBDN Systems and products:
 - GigaFlex Cable: 1200, 2400, 4800LX,
 - Bonded-Pair Cable: DataTwist 350, MediaTwist, DataTwist 600e,
 - GigaBIX and FiberExpress Solutions
- Certification Overview
- Installation Preambles for Belden IBDN Systems
- Work Area Products Installation:
 - GigaFlex Modules, Face Plates and Workstation Outlets
- BIX and GigaBIX Solutions:
 - IDC System Installation
 - Wall-Mount, Rack Mount Patch Panel System Installation
- Modular Jack and Patch Cord System
- High Density PS5E/PS6+ Patch Panel System
- PS5E Patch Box and Multi-user Box
- PS5E DVO Outlets, MDVO Adapters and EZ-MDVO Modules

- Optical Fiber Overview
 - Belden IBDN FiberExpress Systems and products
 - Products Overview, Fiber Termination, (1U/2U), (3U) and (4U) Patch Panel Installation
- OPTIMAX Field Installable Connector (ST, SC, LC)
- Breakout Kit Installation
- 10GX Solution Overview
- Reference Materials
- 75% In-Class Exercises

Prerequisite: None

Written Exam: No

BICSI CECs: RCDD (14),
INS, Level 2/Technician (14)

Belden IBDN Training

Course Descriptions

Belden IBDN 726

Belden IBDN Copper Products

(1 day)

Who Should Attend:

Structured Cabling Installers

Course Benefits:

Gain the ability to install copper structured cabling systems.

What Will be Covered:

- Belden Company Overview
- Belden IBDN Systems and products:
 - GigaFlex Cable: 1200, 2400, 4800LX,
 - Bonded-Pair Cable: DataTwist 350, MediaTwist, DataTwist 600e,
 - GigaBIX
- Installation Preambles for Belden IBDN Systems
- Work Area Products Installation:
 - GigaFlex Modules, Face Plates and Workstation Outlets
- BIX and GigaBIX Solutions:
 - IDC System Installation
 - Wall-Mount, Rack Mount Patch Panel System Installation
- Modular Jack and Patch Cord System
- High Density PS5E/PS6+ Patch Panel System
- PS5E Patch Box and Multi-user Box
- PS5E DVO Outlets, MDVO Adapters and EZ-MDVO Modules
- 10GX Solution Overview
- Reference Materials
- 75% In-Class Exercises

Prerequisites: None

Written Exam: No

BICSI CECs: RCDD (7),
INS, Level 2/Technician (7)

Belden IBDN 746

Belden IBDN Fiber Product

(1 day)

Who Should Attend:

Structured Cabling Installers

Course Benefits:

Gain an understanding of the principles behind Optical Fiber cabling media.

Gain the ability to install Optical Fiber components and solutions.

What Will Be Covered:

- Belden Company Overview
- Optical Fiber Overview
 - Belden IBDN FiberExpress System and products
 - Products Overview, Fiber Termination, (1U/2U), (3U) and (4U) Patch Panel Installation
- OPTIMAX Field Installable Connector (ST, SC, LC)
- Breakout Kit Installation
- Reference Materials
- 75% In-Class Exercises

Prerequisite: None

Written Exam: No

BICSI CECs: RCDD (7),
INS, Level 2/Technician (7)

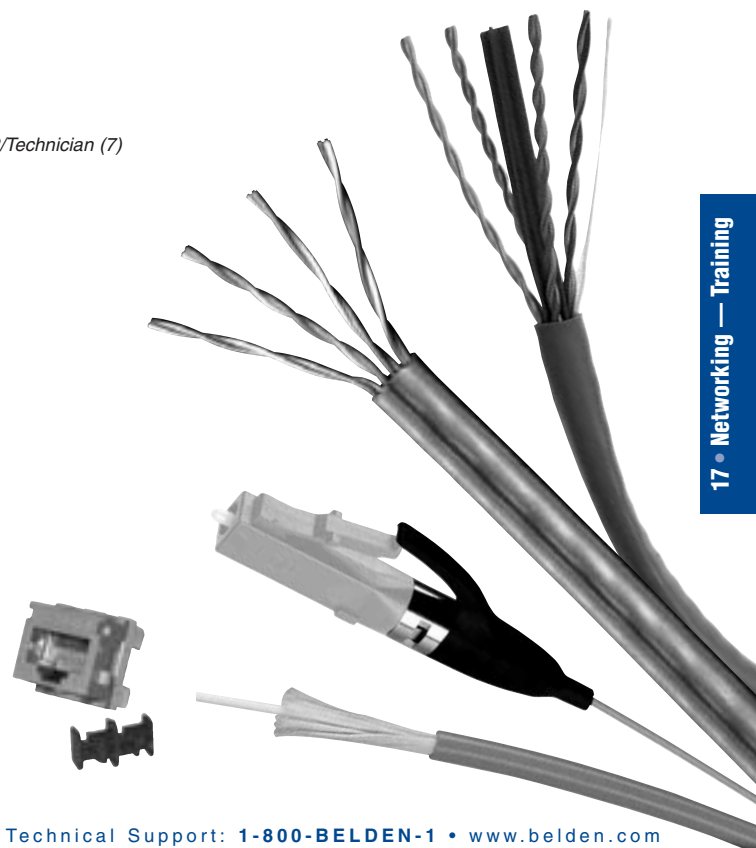

Belden IBDN Training

Course Descriptions

Belden IBDN 727

Belden IBDN End-to-End Installation and Testing — Copper Media

(2 days)

Who Should Attend:

Belden Channel Partners or Employees

Contractors, technicians, supervisors, engineers and designers

Course Benefits:

Learn detailed installation methods of key copper Belden IBDN System components.

Learn appropriate methods and procedures of testing copper Belden IBDN Systems.

What Will Be Covered:

- Review Belden IBDN Systems and key copper components
- Basic balanced twisted-pair transmission and performance theories
- Installation practice reviews
- Installation and testing of end-to-end systems
- In detail, installation methods of:
 - Copper Belden IBDN Systems components,
 - Belden IBDN 1200, 2400 and 4800LX Systems including:
 - GigaFlex Cable: 1200, 2400 and 4800LX,
 - Bonded-Pair Cable: DataTwist 350, MediaTwist, DataTwist 600e
- Learn testing methods of Belden IBDN Systems and how to troubleshoot typical problems
- Understand the correlation between:
 - Basic theories of end-to-end system transmission,
 - Component and system installation practices,
 - Test results and system performances
- 10GX Solution Overview
- 90% In-Class Exercises

Prerequisite: None

Written Exam: Yes

BICSI CECs: RCDD (14),
INS, Level 2/Technician (14)

Belden IBDN 747

Belden IBDN End-to-End Installation and Testing — Optical Fiber Media

(2 days)

Who Should Attend:

Belden Channel Partners or Employees

Contractors, technicians, supervisors, engineers and designers

Course Benefits:

Learn detailed installation methods of key Belden IBDN FiberExpress System components.

Learn appropriate methods and procedures of testing Belden IBDN FiberExpress Systems.

What Will Be Covered:

- Review Belden IBDN FiberExpress Systems and key fiber components
- Basic optical fiber transmission and performance theories
- Installation practice reviews
- Installation and testing of end-to-end systems
- In detail, installation methods of:
 - Belden IBDN FiberExpress System components,
 - Belden IBDN FiberExpress Systems including: Multimode (FX300, FX600 and FX2000) and Single-mode systems
- Learn testing methods of Belden IBDN Systems and how to troubleshoot typical problems
- Understand the correlation between:
 - Basic theories of end-to-end system transmission,
 - Component and system installation practices,
 - Test results and system performances
- 90% In-Class Exercises

Prerequisite: None

Written Exam: Yes

BICSI CECs: RCDD (14),
INS, Level 2/Technician (14)





Industrial Automation and Control Cables

18

Table of Contents

Industrial Automation and Control Cables	Page No.
Introduction	18.2
PLC/DCS Cross Reference Guide	18.2-18.5
Industrial Communications Protocol	18.6
Industrial Data Solutions®	18.7-18.29
Industrial Ethernet:	
Introduction: Overview	18.7
DataTuff® Twisted Pair Cables, Category 5e	18.8
DataTuff Twisted Pair Cables, Category 6	18.11
TrayOptic® Fiber Optic Cables	18.12
Coaxial Cables	18.13
Industrial Twinax:	
Belden® Blue Hose® Selection Guide for PLC/DCS Applications	18.14
Blue Hose Cables	18.15
Twinaxial Cables	18.16
DataTray® 600V Twinaxial Cables	18.18
Industrial Coax:	
ControlNet™ Quad Shielded Coax	18.19
ControlBus™ Quad Shielded Coax	18.20
Industrial Data:	
DataBus® ISA/SP-50 FOUNDATION Fieldbus or Profibus Cables	18.21
DeviceBus® for ODVA DeviceNet™	18.22
DeviceBus for Honeywell Smart Distributed System	18.25
DeviceBus for Square D/Seriplex®	18.26
DeviceBus for Phoenix Contact InterBus®-S	18.27
EIA Industrial RS-485 PLTC/CM	18.28
Interconnect	18.29
VFD (Variable Frequency Drive) Cable	18.30
Belden Infinity® Flexible Automation Cable	18.31-18.40
Introduction: Overview & Application Guide	18.31
C-TC+ Control Cables: 600V Multi-conductor	18.32
FCC Control Cables: 600V Multi-conductor	18.34
Flex Data Cables: 300V Twisted Pairs	18.39
Flex Vision Cables: 75 Ohm Coax	18.40
UL Instrumentation Cable	18.41-18.62
300V Power-limited Tray Cables: Overview	18.41
300V PLTC/ITC: Pairs & Triads	18.42
Thermocouple Extension Cable & Wire: Overview	18.53
Thermocouple Extension Cables: Shielded Pairs	18.54
Thermocouple Extension Cables: High-Temperature, Plenum	18.55
Thermocouple Wire: Unshielded	18.55
600V Tray Cables: Overview	18.56
600V Tray Cables: Pairs & Triads	18.57
UL Control Cable	18.63-18.76
600V Type TC Cables: Overview	18.63
600V Type TC Cables: Multi-conductor	18.64
600V Type MC & Teck-Style® Cables: Overview	18.70
600V Type MC Cables: Multi-conductor	18.71
600V Dual-rated Type MC/Teck 90 Teck-Style Cables	18.74
CSA Instrumentation Cable	18.77-18.83
300V TC/CIC: Pairs & Triads	18.77
300V CIC: Pairs & Triads and Overview	18.78
300V ACIC: Armored Pairs & Triads	18.80
600V CIC: Pairs & Triads	18.82
600V ACIC: Armored Pairs & Triads	18.83
CSA Control Cable	18.84-18.95
600V and 1000V: TC/CIC Multi-conductor	18.84
600V: CIC Multi-conductor	18.85
600V: ACIC & Teck90	18.87
1000V: Teck90	18.92
1000V: VFD Cable	18.95
Technical Information	18.96-18.98

ControlNet is a ControlNet International trademark. • DeviceNet is an Open DeviceNet Vendor Association, Inc. trademark. Interbus is a Phoenix Contact trademarks. • Seriplex is a Square D/Schneider AEG registered trademark.



Belden IndustrialTuff® Cables

Introduction

Tough Cables for Tough Environments

Today, more than ever, manufacturing productivity depends upon seamless data communication and automation systems. And both depend upon high-performance cabling solutions.

Depend on Belden

Belden has developed the world's most comprehensive line of industrial cabling solutions for applications like yours: whether you are networking your factory floor or your process equipment and devices to their controllers...and on to the control room, or relaying data between the control room, the engineering department, and remote manufacturing sites — or, all of the above. From your petrochemical, automotive manufacturing, pharmaceutical, power generation, pulp and paper, metals, food and beverage, or general manufacturing plant to your corporate headquarters — and everywhere in between — Belden has your cabling solution.

Most importantly you can have the peace-of-mind that is inherent with the use of Belden products since all Belden cables are manufactured in ISO 9001:2000 certified facilities to the industry's highest standards of quality, utilizing the most advanced equipment, systems, controls and processes available.

Belden cables give you the performance you need day after dependable day.

Innovative Technology

Bonded-Pairs

Many DataTuff® Industrial Ethernet cables feature Belden's patented bonded-pair technology. Bonded-pairs provide *Installable Performance*® — superior electrical performance even after the stresses of installation. Bonded-pairs exhibit the most robust and reliable electrical performance in the industry.

Shielding

The evolution of technology maintains steady demand for sophisticated cable shielding. Belden meets that demand with innovative shielding and shield effectiveness testing methods to supply you with high quality, dependable cable.

Belden's exclusive patented Beldfoil® design, with its aluminum/polyester foil, was the first shield to offer 100 percent cable protection against radiated emission and ingress at audio and radio frequencies.

Armoring

Belden's innovative armoring technology delivers maximum physical protection in harsh environments. Additional benefits include reduced cost of conduit, easier installation and re-routing, plus additional shielding.

Belden has the capability to protect data, electronic, instrumentation and control cables with interlocking steel or aluminum armor as well as continuous corrugated aluminum armor. Smooth or corrugated protective metal tapes are also available.

Insulation and Jacket

Belden formulates many of its own insulations and jacket compounds. As a result, they provide superior performance under a variety of hostile environmental conditions. See "Technical Information" at the back of this section for further details.

Intrinsically Safe Wiring

In accordance with NEC Article 504, intrinsically safe cables are colored blue for easy identification. Belden offers several industrial cables in intrinsically safe blue to meet your requirements for intrinsically safe wiring. Contact the NEC and/or your local inspector for specific guidelines.

Custom Capabilities

Most of our Industrial cables are available from stock. Many of these are available off the shelf from distributors. If you have a new or unusual application or you cannot find an Industrial cable in this catalog section that meets your technical requirements, contact Technical Support at 1-800-BELDEN-1.

To Specify Part Number:

1	2	3456
Overall Jacket Type	Armor Type	Core Trade Number

Overall Jacket Type Armor Type

Code	Material	Code	Material
1	PVC	2	Aluminum Interlock
3	CPE	3	Steel Interlock
4	TPE	8	Continuous Corrugated Aluminum
5	HDPE		
6	Oil Res II		
7	Haloarrest®		

PLC/DCS Cable Cross Reference Guide

PLC/DCS Manufacturer	System Name	Belden Part Number	
ABB/Bailey Controls	FOUNDATION Fieldbus	See Protocol listings on page 8.6	
	Industrial IT 800 X A	9880 Network Trunk Cable	
	Infinet	9880 Network Trunk Cable 9463 Blue Hose® (Standard)	
	Masterpiece 200	9880 Network Trunk Cable 9907 Thin Network Trunk Cable	
	MICRO-DCI	3105A 1-Pair, RS-485	
	MICROLINK	9860 Twinax, 16 AWG, 124 Ohm	
	Modcell	3105A 1-Pair, RS-485	
	Profibus DP & PA	See Protocol listings on page 8.6	
	Allen-Bradley/Rockwell Automation	ControlNet™	See Protocol listings on page 8.6
		DeviceNet™	See Protocol listings on page 8.6
DH, DH+, Remote I/O		9463 Blue Hose (Standard) 9463F Flexible Version (9463) 129463 Aluminum Armor (9463) 139463 Steel Armor (9463) 189463 Continuous Armor (9463) YR28826 Dual Version (9463) YC39151 Dual Armored (9463) 9463DB Direct Burial (9463) YR29565 Various Color Jackets (9463) 3072F 600V TC Rated (9463) YR41104 Low Smoke, Halogen Free YR28764 Super Thick (PLTC) 89463 FEP 200°C, Plenum	
DH-485		3074F 600V Tray Cable 3106A 1.5-Pair, RS-485 (PLTC) 9842 2-Pair, RS-485 YM39500 Flexible Version (3106A)	
Industrial Ethernet		See Protocol listings on page 8.6	
Longline Communications		8723 Interface Cable 88723 Plenum Version	
Cutler-Hammer/Westinghouse		IMPACC System YR29090 Proprietary Trunk Cable I/O System 9463 Blue Hose (Standard)	
Emerson Process Management (Fisher/Rosemont Systems) — Delta V		DeviceNet	See Protocol listings on page 8.6
		FOUNDATION Fieldbus (Type SP50 ISA/IEC)	See Protocol listings on page 8.6
		HART	See Protocol listings on page 8.6
		Industrial Ethernet	See Protocol listings on page 8.6
		Modbus	See Protocol listings on page 8.6
		Profibus DP	See Protocol listings on page 8.6
		Provox Plus	3091A RG-11 Quad Shield PVC 3131A RG-6 Quad Shield PVC
		RS-485	See Protocol listings on page 8.6
GE Fanuc — I/O Bus		DeviceNet	See Protocol listings on page 8.6
		Genius 9030, 9070 PAC System	YR29841 PLTC Version 9182 Communications Bus 89182 Plenum Version
		Interbus®-S	See Protocol listings on page 8.6
		Modbus®	See Protocol listings on page 8.6
		Profibus	See Protocol listings on page 8.6

PLC/DCS Manufacturer	System Name	Belden Part Number	
GE Fanuc — Sensor Device Networks	DeviceNet	See Protocol listings on page 8.6	
	SDS	See Protocol listings on page 8.6	
Honeywell	Access 4000 System	9248 RG-6 PVC	
	FOUNDATION Fieldbus (Type SP50 ISA/IEC)	See Protocol listings on page 8.6	
	IPC 620 System I/O	9271 Twinax, 25 AWG, 124 Ohm	
	IPC 620 System	9729 Up to 4,000 ft.	
	Serial Interface	9182 Up to 10,000 ft. 89182 Plenum	
	Series C	RS-485 Foundation Fieldbus Industrial Ethernet	
	3000 UCN & LCN	3131A RG-6 Quad Shield PVC	
		3094A RG-11 Quad Shield PVC	
	Honeywell Microswitch Division	Smart Distributed System	3086A Mini 3087A Micro
	Invensys/Foxboro	FOUNDATION Fieldbus (Type SP50 ISA/IEC)	See Protocol listings on page 8.6
I/A Series Carrier Band		8233 Small Trunk	
		3095A Plenum	
		9290 Drop Cable	
I/A Series Fieldbus		9207 Twinax	
		89207 200°C, Plenum	
		3073F 600V Tray Cable	
I/A Series Node Bus		9880 Trunk Cable	
		89880 Plenum Version	
Industrial Ethernet		See Protocol listings on page 8.6	
Limitorque	DCC100	3105A Actuator Bus Cable, 1-Pair, RS-485	
Matsushita	FP Series C-NET	9207 Twinax, 20 AWG, Stranded, 100 Ohm	
		9860 Twinax, 16 AWG, Solid, 124 Ohm	
	FP Series MEWNET-F	9207 Twinax, 20 AWG, Stranded, 100 Ohm	
		9860 Twinax, 16 AWG, Solid, 124 Ohm	
	FP Series MEWNET-H	9248 RG-6, 75 Ohm, 18 AWG	
	FP Series MEWNET-TR	9207 Twinax, 20 AWG, Stranded, 100 Ohm	
		9860 Twinax, 16 AWG, Solid, 124 Ohm	
	FP Series MEWNET-W	9207 Twinax, 20 AWG, Stranded, 100 Ohm	
		9806 4-Pair, RS-232, RS-422	
	FP Series MEWNET-W2	9207 Twinax, 20 AWG, Stranded, 100 Ohm	
9860 Twinax, 16 AWG, Solid, 124 Ohm			
FP Series TRNET	9207 Twinax, 20 AWG, Stranded, 100 Ohm		
	9860 Twinax, 16 AWG, Solid, 124 Ohm		

FEP = Fluorinated Ethylene-propylene



PLC/DCS Cable Cross Reference Guide *(continued)*

PLC/DCS Manufacturer	System Name	Belden Part Number		
Mitsubishi Electric Automation	CC-Link	See Protocol listings on page 8.6		
	DeviceNet	See Protocol listings on page 8.6		
	Melsecnet II (10/10H)	1505A	Precision RG-59/U Coax	
		1505F	High-Flex 1505A	
		1506A	Plenum Precision RG-59/U, Outdoor, Direct Burial	
		8241	Standard RG-59/U Coax	
		8241F	High-Flex 8241F	
	Modbus	See Protocol listings on page 8.6		
	Profibus DP	See Protocol listings on page 8.6		
	Serial Communications	8777 Control and Instrumentation Interconnect Cable		
Modicon/Schneider AEG	Industrial Ethernet	See Protocol listings on page 8.6		
	Modbus	8777	Modem Drop Cable, 22 AWG, 3-Pair	
		128777	Aluminum Armor (8777)	
		138777	Steel Armor (8777)	
		88777	FEP 200°C, Plenum	
	Modbus II	3092A	RG-6 Quad Shield PVC	
		3132A	RG-6 Quad Shield, 150°C, Plenum	
		3092F	RG-6 Quad Shield PVC, Flexible Version	
		123092A	Aluminum Armor (3092A)	
	Modbus Plus	133092A	Steel Armor (3092A)	
		YM29560	24 AWG, 1-Pair, RS-485	
		YC39000	Aluminum Armor (YM29560)	
		YC39222	Steel Armor (YM29560)	
	Remote I/O	YQ29258	24 AWG, 1-Pair, 150°C, Plenum	
		3092A	RG-6 Quad Shield PVC	
			RG-6 Quad Shield PVC, Flexible Version	
		3092F	Aluminum Armor (3092A)	
			Steel Armor (3092A)	
		123092A	Aluminum Armor, RG-6 Quad Shield PVC	
			Aluminum Armor, RG-6 Quad Shield, 150°C, Plenum	
3094A		RG-11 Quad Shield PVC		
		Aluminum Armor (3094A)		
123094A		Steel Armor (3094A)		
		RG-11 Quad Shield, 150°C, Plenum		
Omron		ComboBus/D (DeviceNet™)	See DeviceNet Protocol listings on page 8.6	
		ComboBus/S	9409	18 AWG, 1-Pair, 300V PLTC Control
			9318	18 AWG, 1-Pair, 300V PLTC Control, Shielded
			3073	600V Tray Cable, Twinax
89740			18 AWG, 1-Pair, 300V, Control	

PLC/DCS Manufacturer	System Name	Belden Part Number
Omron <i>(continued)</i>	Controller Link	9207 Twinax
		89207 Twinax, 200°C, Plenum
		9815 Twinax, 100 Ohm, Direct Burial
		3073F 600V Tray Cable, Twinax
		3073F 600V Tray Cable, Twinax
	SYSBUS-2	3073F 600V Tray Cable, Twinax
	SYSMAC BUS	9841 22 AWG, 1-Pair, RS-485
		3105A 22 AWG, 1-Pair, RS-485
	SYSMAC LINK	9231 RG-59U Coax
	Phoenix Contact	DeviceNet
Industrial Ethernet		See Protocol listings on page 8.6
Interbus®-S		See Protocol listings on page 8.6
Profibus DP FMS & PA		See Protocol listings on page 8.6
Reliance/A-B	Auto Max Distributed Power	M98021 2-Fiber Breakout
		I100255 2-Fiber Loose Tube PVC
		I100266 2-Fiber Loose Tube CPE
	R-Net	9259 RG-59 PVC
	89259 RG-59, 200°C, Plenum	
Rotork Siemens/Moore	Pakscan II E RS-485 FMC (Field Mountable Controller)	3105A 22 AWG, 1-Pair, RS-485
		3105A 1-Pair, RS-485
		3106A 1.5-Pair, RS-485
		3107A 2-Pair, RS-485
		3108A 3-Pair, RS-485
		3109A 4-Pair, RS-485
	FOUNDATION Fieldbus (Type SP50 ISA/IEC)	See Protocol listings on page 8.6
	Hiway	9860 Network Trunk Cable
	Industrial Ethernet	See Protocol listings on page 8.6
	MODULNET	3094A RG-11 Quad Shield PVC
3131A RG-6 Quad Shield PVC		
Profibus DP & FMS (Purple)	See Protocol listings on page 8.6	
Profibus PA (Blue)	See Protocol listings on page 8.6	
SINEC Series H1	9907 Thin Network Trunk Cable	
	9880 Network Trunk Cable	
SINEC Series H2B	3131A RG-6 Quad Shield	
	3094A RG-11 Quad Shield	
SINEC Series L1	3107A 2-Pair, RS-485	
SINEC Series L2	3079A 300V Twinax	
Thicknet Ethernet Trunk	9880 Network Trunk Cable	
	129880 Aluminum Interlocked Armor Trunk	
	139880 Steel Interlocked Armor Trunk	
Thinnet Ethernet Trunk	9907 Thin Network Trunk Cable	

FEP = Fluorinated Ethylene-propylene



PLC/DCS Cable Cross Reference Guide *(continued)*

PLC/DCS Manufacturer	System Name	Belden Part Number	
Smar	FOUNDATION Fieldbus (Type SP50 ISA/IEC)	See Protocol listings on page 8.6	
	Industrial Ethernet	See Protocol listings on page 8.6	
	Profibus DP FMS & PA	See Protocol listings on page 8.6	
	RS-485	See Protocol listings on page 8.6	
Square D/ Schneider AEG	FIP/Fieldbus	3079A 22 AWG, 1-Pair, Shielded 123079A Aluminum Armor (3079A)	
	Industrial Ethernet	See Protocol listings on page 8.6	
	Model 50, RS-422 Cable	8760 18 AWG, 1-Pair, Shielded 128760 Aluminum Armor (8760)	
	Passport I/O – I/O Net	3105A 22 AWG, 1-Pair, RS-485 123105A Aluminum Armor (3105A)	
		3106A 22 AWG, 1.5-Pair, RS-485 123106A Aluminum Armor (3106A)	
		Power Logic	9841 24 AWG, 1-Pair, RS-485 9842 24 AWG, 2-Pair, RS-485
		Seriplex®	3124A CBL-1822-P20 3125A CBL-1622-P16 3126A CBL-162212-P16 123124A Aluminum Armor (3124A) 123125A Aluminum Armor (3125A) 123126A Aluminum Armor (3126A) 9463 Blue Hose® (Standard) 9463F Flexible Version (9463) 129463 Aluminum Armor (9463) 139463 Steel Armor (9463) 189463 Continuous Armor (9463) YR28826 Dual Version (9463) 9463DB Direct Burial (9463) YR29565 Various Color Jackets 9463)
	SY/Net Network Trunk Cable	3072F 600V TC Rated (9463) YR41194 Low-Smoke, Halogen-Free YR28764 Super Thick (PLTC) 89463 FEP 200°C, Plenum	
		SY/Net TNIM Cable	9272 20 AWG, 1-Pair, Shielded 89272 FEP 200°C, Plenum

PLC/DCS Manufacturer	System Name	Belden Part Number
Yokogawa — CENTUM	DeviceNet™	See Protocol listings on page 8.6
	FOUNDATION Fieldbus (Type SP50 ISA/IEC)	See Protocol listings on page 8.6
	HART	See Protocol listings on page 8.6
	Industrial Ethernet	See Protocol listings on page 8.6
	Profibus	See Protocol listings on page 8.6
Yokogawa — FA-M3	RS-485	See Protocol listings on page 8.6
	DeviceNet	See Protocol listings on page 8.6
	Industrial Ethernet	See Protocol listings on page 8.6
	Modbus	See Protocol listings on page 8.6
	Profibus	See Protocol listings on page 8.6
Yokogawa — STARDOM	RS-485	See Protocol listings on page 8.6
	DeviceNet	See Protocol listings on page 8.6
	FOUNDATION Fieldbus (Type SP50 ISA/IEC)	See Protocol listings on page 8.6
	HART	See Protocol listings on page 8.6
	Industrial Ethernet	See Protocol listings on page 8.6
Westinghouse	Profibus	See Protocol listings on page 8.6
	RS-485	See Protocol listings on page 8.6
	WDPF	9292 RG-11 PVC

FEP = Fluorinated Ethylene-propylene

ControlNet is a ControlNet International, Ltd. trademark.

DeviceNet is an Open DeviceNet Vendor Association, Inc. trademark.

EtherNet/IP is a ControlNet International, Ltd. trademark, under license by Open DeviceNet Vendor Association, Inc.

HART is a HART Communication Foundation trademark.

InterBus is a Phoenix Contact trademark.

Modbus is a Modicon, Inc. trademark.

PROFIBUS is a PROFIBUS International trademark.

PROFINET is a PROFIBUS International trademark.

SDS is a Honeywell International, Inc. trademark.

Seriplex is a Square D/Schneider AEG trademark.

Industrial Communications Protocol Cross Reference

System Name	Belden Part Number
Can Open/HART/ RS-485	3105A 1-Pair, RS-485 (PLTC)
	3106A 1.5-Pair, RS-485 (PLTC)
	3107A 2-Pair, RS-485 (PLTC)
CC-Link	YR47198 20 AWG/3c, Foil + Braid Shield
	YR47205 20 AWG/3c Shielded + 18 AWG/2c Power
ControlNet™	3092A RG-6 PVC Quad Shield
	3092F RG-6 PVC Quad Shield, Flex Version, Aluminum Braid
	YR28890 RG-6 PVC Quad Shield, Flex Version, Copper Braid
	3093A RG-6 FEP Quad Shield, Plenum
	123092A Aluminum Armor (3092A)
	133092A Steel Armor (3092A)
	183092A Continuous Armor (3092A)
DataHighway (DH) & DataHighway Plus (DH+) Remote I/O	9463 20 AWG Twinax, Blue Hose
	3072F 600V, TC Blue Hose
	9463DB Direct Burial Blue Hose
	9463F High-Flex, Blue Hose
	89463 High-Temp, Plenum Blue Hose
	129463 Aluminum Armor (9463)
	139463 Steel Armor (9463)
	189463 Continuous Armor (9463)
	YR28826 Dual Blue Hose
	YC39151 Dual Armored Blue Hose
	YR28764 Thick Wall PLTC Blue Hose
	YR29565 Colored Blue Hose
	YR41104 Low-Smoke, Zero-Halogen Blue Hose
DeviceNet™	3082A PVC (Thick)
	3082F High-Flex (Thick)
	3082K CL2 (Flat)
	3082KP Auxiliary Power (Flat)
	3083A CPE (Thick)
	3084A PVC (Thin)
	3084F High-Flex (Thin)
	3085A CPE (Thin)
	7895A CL2 PVC (Cable III Mid)
	7896A CL1 PVC (Type V Trunk Cable)
	7897A CL1 PVC (Thick)
	7900A CL1 Unshielded (Drop Cable IV)
	FOUNDATION Fieldbus (Type SP50 ISA/IEC)
3077F Type B, H1 1200m (31.25K)	
HSE Copper & Fiber (see <i>Cables for Industrial Ethernet</i> , pg. 18.6)	
Hart/RS-485/ Can Open	3105A 1-Pair, RS-485 (PLTC)
	3106A 1.5-Pair, RS-485 (PLTC)
	3107A 2-Pair, RS-485 (PLTC)
Industrial Ethernet	7932A Cat 5e, 2-Pair, Bonded
	7933A Cat 5e, 2-Pair, Bonded, Shielded
	7918A Cat 5e, 4-Pair
	7924A Cat 5e, 4-Pair, Bonded, Flexible
	7930A Cat 5e, 4-Pair, Flexible
	7922A Cat 5e, 4-Pair, Bonded, PLTC
	7934A Cat 5e, 4-Pair, Bonded, Burial

System Name	Belden Part Number	
Industrial Ethernet (continued)	11700A Cat 5e, 4-Pair, Bonded, Upjacketed	
	11700A2 Cat 5e, 4-Pair, Bonded, Upjacketed, Oil Res II	
	121700A Cat 5e, 4-Pair, Bonded, Armored	
	7919A Cat 5e, 4-Pair, Shielded	
	7921A Cat 5e, 4-Pair, Bonded, Shielded (Foil + Braid)	
	7927A Cat 6, 4-Pair, Bonded	
	7931A Cat 6, 4-Pair, Bonded, Gas Res, High + Low Temperature	
	11872A Cat 6, 4-Pair, Bonded, Upjacketed	
	121872A Cat 6, 4-Pair, Bonded, Armored	
	Interbus®-S	3119A 18 AWG/3c, 24 AWG/3-Pair, Composite
		3120A 24 AWG/3-Pair
	IronWorks®	8471 16 AWG, 1-Pair, UL AWM 2598
		8917 16 AWG, 1-Cond, UL AWM 1015
85102 16 AWG, 2-Cond, VW1, Plenum		
Modbus	8777 22 AWG, 3-Pair, Modem Drop Cable	
	128777 Aluminum Armor (8777)	
	138777 Steel Armor (8777)	
	88777 FEP 200°C, Plenum (8777)	
Profibus DP & FMS (Purple)	3079A 22 AWG 300V Twinax	
	3079E 22 AWG 300V Twinax, Flex Version	
Profibus PA (Blue)	3076F 18 AWG, 2-Conductors, Type A	
RS-485/HART/ Can Open	9841 1-Pair	
	82841 1-Pair, Plenum	
	89841 1-Pair, Plenum, High-Temperature	
	9842 2-Pair	
	82842 2-Pair, Plenum	
	9843 3-Pair	
	9844 4-Pair	
	7200A 1-Pair, RS-485, Hi-Flex	
	7201A 2-Pair, RS-485, Hi-Flex	
	7202A 3-Pair, RS-485, Hi-Flex	
	7203A 4-Pair, RS-485, Hi-Flex	
	7206A 1-Pair, RS-485, Hi-Flex	
	3105A 1-Pair, RS-485 (PLTC)	
3106A 1.5-Pair, RS-485 (PLTC)		
3107A 2-Pair, RS-485 (PLTC)		
3108A 3 Pair, RS-485 (PLTC)		
3109A 4 Pair, RS-485 (PLTC)		
Seriplex®	3124A 1-Pair 18 AWG, 1-Pair 22 AWG	
	3125A 1-Pair 16 AWG, 1-Pair 22 AWG	
	3126A 1-Pair 16 AWG, 1-Pair 22 AWG, 1-Pair 12 AWG	
	123124A Aluminum Armor (3124A)	
	123125A Aluminum Armor (3125A)	
123126A Aluminum Armor (3126A)		
Smart Distributed System (SDS)	3086A 1-Pair 16 AWG, 1-Pair 20 AWG	
	3087A 2-Pairs 22 AWG	

FEP = Fluorinated Ethylene-propylene

Industrial Data Solutions® — Industrial Ethernet

DataTuff® Twisted Pair and TrayOptic® Fiber Optic Cables

Overview

The reliability of your industrial Ethernet network depends on the cable infrastructure. Data transmission errors can lead to interruptions in critical control functions resulting in lost production time and even safety issues. Belden's family of industrial Ethernet cables is designed to withstand the rigors of industrial environments. Whether it's exposure to oil and sunlight, temperature variation, abrasion and crushing, or the presence of electromagnetic interference (EMI) or radio frequency interference (RFI), turn to Belden for the solution.

Belden offers an extensive line of high performance cables in both copper constructions with DataTuff cables as well as fiber optic designs with TrayOptic cables.

Performance Assurance from Blue Hose® to Industrial Ethernet

To assist you in achieving optimum network performance, Belden has built

quality and reliability into each cable it manufactures. Decades of leadership and experience in supplying reliable high-end cable solutions, such as Blue Hose®, to industrial networks and control systems are combined to give you industrial Ethernet cables that perform to maximum network capability.

Our dedication to quality manufacturing practices and processes assures consistent products of uncompromising quality.

Installable Performance® with Patented Bonded-Pair Technology

Belden's Bonded-Pair versions of DataTuff cables are unique in the industry to give you an Installable Performance advantage. This patented design yields superior electrical performance even after the effects and stresses of pulling, twisting and bending during typical installations.

This performance advantage is achieved by bonding the individual insulated conductors along their longitudinal axes, resulting in uniform conductor-to-conductor spacing and the elimination of gaps between conductors that can occur during installation. This is a critical construction feature because non-uniform conductor spacing and gaps change the physical characteristics of the cable such that the electrical performance of the cable suffers. Only Bonded-Pair cables deliver the electrical integrity you demand.

TrayOptic Cables

Belden® TrayOptic cables are a line of indoor/outdoor fiber optic cables designed to meet the demanding requirements of industrial applications. When the installation demands the combination of sophisticated fiber optic technology and rugged durability, turn to Belden.

DataTuff® Industrial Ethernet Cable Selection Guide

Part No.	No. of Pairs	Shielding		Conductor		Installation		Environmental Issues					Industrial Grade Jacket			
		Unshielded	Shielded *	Solid	Stranded **	Installation Stress Resistance†	Pull Tension	Oil Resistance	UV Sunlight Resistance	CMX/Outdoor	Underground (burial)	Gasoline Resistance	Hi/Lo Temp	Heavy	Upjacket	Armored
Category 5e Cable																
new 7932A <i>EtherNet/IP</i>	2	●		●		●	20	●	●							●
new 7933A <i>EtherNet/IP</i>	2		●	●		●	20	●	●							●
7923A <i>EtherNet/IP</i>	4	●		●		●	40	●	●	●						●
7918A	4	●		●			35	●	●	●						●
7924A	4	●			●	●	40	●	●	●						●
new 7930A	4	●			●		25	●	●	●						●
new 7922A PLTC	4	●		●		●	40	●	●	●						●
new 7934A <i>EtherNet/IP</i>	4	●		●		●	40		●		●					●
7928A <i>EtherNet/IP</i>	4	●		●		●	40	●	●		●	●				●
11700A <i>EtherNet/IP</i>	4	●		●		●	40	●	●	●						●
new 11700A2 Oil Res I&II	4	●		●		●	40	●	●							●
121700A	4	●		●		●	40	●	●							●
new 121700R	4	●		●		●	40	●	●							●
7929A	4		●	●		●	35	●	●	●						●
7919A	4		●	●		●	25	●	●	●						●
7921A <i>EtherNet/IP</i>	4		●	●		●	75	●	●	●						●
Category 6 Cable																
7927A	4	●		●		●	45	●	●							●
7931A	4	●		●		●	40	●	●		●	●				●
11872A	4	●		●		●	45									●
121872A	4	●		●		●	45	●	●							●

*Shielded products are recommended for high-noise environments. **Stranded products are recommended where more flexibility is needed.

†Products with Bonded-Pair technology provide Installable Performance® advantages — refer to Belden's Bonded-Pair Cable Bulletin #BP02

EtherNet/IP is a trademark of ControlNet International, Ltd. under license by Open DeviceNet Vendor Association, Inc.

Industrial Data Solutions® — Industrial Ethernet

Category 5e DataTuff® Twisted Pair Cables, 2-Pair and 4-Pair

Heavy-Duty Sunlight and Oil-Resistant Jackets

Description	Part No.	UL NEC/ C(UL) CEC Type	No. of Pairs	Standard Lengths		Standard Unit Wt.		Nominal OD		Freq. (MHz)	Max. Atten. (dB/100m)	Min. PSUM NEXT (dB)	Min. PSUM ACR (dB/100m)	Min. PSUM ELFEXT (dB/100m)	Input Imped. (Ω)	Min. RL (dB)
				Ft.	m	Lbs.	kg	Inch	mm							

Enhanced Cat 5e • 24 AWG Bonded-Pairs Solid BC Conductors • Rip Cord • See Color Codes below

Polyolefin Insulation • .030" Industrial Grade Sunlight- and Oil-resistant PVC Jacket (Black, Red or Teal)

Polyolefin Insulation • .030" Industrial Grade Sunlight- and Oil-resistant PVC Jacket (Black, Red or Teal)																
EtherNet/IP Compliant 	7932A <small>new</small>	NEC: CMR CEC: CMR FT4	2	1000	304.8	19.0	8.61	.207	5.26	1	2.0	65.3	63.3	60.8	100±12	20.0
				2000 ▲	609.6	38.0	17.24	4	4.0	56.3	52.3	48.7	100±12	23.6		
				8	5.7	51.8	46.1	42.7	100±12	25.4						
				10	6.4	50.3	43.9	40.8	100±12	26.0						
				16	8.1	47.3	39.1	36.7	100±12	26.0						
				25	10.3	44.3	34.1	32.8	100±15	25.5						
				31.25	11.6	42.9	31.3	30.9	100±15	25.0						
				62.5	16.8	38.4	21.6	24.8	100±15	23.5						
				100	21.7	35.3	17.1	20.8	100±15	22.5						
				155	27.7	32.5	4.7	16.9	100±18	19.0						
				200	32.0	30.8	3.0	14.7	100±20	19.0						
250	36.4	29.3	—	12.8	100±20	18.0										
350	44.3	27.2	—	9.9	100±22	17.0										

*2000 ft. put-up available in Black only. • M-12 or RJ-45 Compatible • Jacket sequentially marked at 2 ft. intervals
 Cable passes -40°C Cold Bend per UL1581 • Installation Temperature: -25°C to +75°C • Operating Temperature: -40°C to +75°C**
 Third party verified to TIA/EIA-568-B.2, Category 5e • U.S. Patents 5,606,151 and 5,734,126

Polyolefin Insulation • .030" Industrial Grade Sunlight- and Oil-resistant PVC Jacket (Black, Red or Teal)																
EtherNet/IP Compliant 	7923A	NEC: CMR, CMX- Outdoor CEC: CMR FT4	4	1000	304.8	28.0	12.7	.230	5.84	1	2.0	65.3	63.3	60.8	100±12	20.0
				2000 ▲	609.6	54.0	24.5	4	4.0	56.3	52.3	48.7	100±12	23.6		
				8	5.7	51.8	46.1	42.7	100±12	25.4						
				10	6.4	50.3	43.9	40.8	100±12	26.0						
				16	8.1	47.3	39.1	36.7	100±12	26.0						
				25	10.3	44.3	34.1	32.8	100±15	25.5						
				31.25	11.6	42.9	31.3	30.9	100±15	25.0						
				62.5	16.8	38.4	21.6	24.8	100±15	23.5						
				100	21.7	35.3	17.1	20.8	100±15	22.5						
				155	27.7	32.5	4.7	16.9	100±18	19.0						
				200	32.0	30.8	3.0	14.7	100±20	19.0						
250	36.4	29.3	—	12.8	100±20	18.0										
350	44.3	27.2	—	9.9	100±22	17.0										

*2000 ft. put-up available in Black only. • RJ-45 Compatible • Jacket sequentially marked at 2 ft. intervals
 Cable passes -40°C Cold Bend per UL1581 • Installation Temperature: -25°C to +75°C • Operating Temperature: -40°C to +75°C**
 Third party verified to TIA/EIA-568-B.2, Category 5e • U.S. Patents 5,606,151 and 5,734,126 • P-07-KA060003-MSHA*

Polyolefin Insulation • Waterblocked Sunlight- and Oil-resistant Black Polyethylene Jacket

Polyolefin Insulation • Waterblocked Sunlight- and Oil-resistant Black Polyethylene Jacket																
EtherNet/IP Compliant Halogen-Free Burial 	7934A <small>new</small>	—	4	1000	304.8	25.0	11.34	.230	5.84	1	2.0	62.3	60.0	60.8	100±15	20.0
				4	4.1	53.3	49.0	48.7	100±15	23.6						
				8	5.8	48.8	43.0	42.7	100±15	25.4						
				10	6.5	47.3	41.0	40.8	100±15	26.0						
				16	8.2	44.3	36.0	36.7	100±15	26.0						
				20	9.3	42.8	33.5	34.7	100±15	26.0						
				25	10.4	41.3	30.9	32.8	100±15	25.5						
				31.25	11.7	39.9	28.0	30.9	100±15	25.0						
				62.5	17.0	35.4	19.0	24.8	100±15	23.5						
				100	22.0	32.3	11.0	20.8	100±15	22.5						
				155	28.1	29.5	1.4	16.9	100±25	15.8						
200	32.0	27.8	1.0	14.7	100±25	15.0										

RJ-45 Compatible • Jacket sequentially marked at 3 ft. intervals
 Cable passes -40°C Cold Bend per UL1581 • Installation Temperature: -25°C to +75°C • Operating Temperature: -40°C to +75°C**
 Third party verified to TIA/EIA-568-B.2, Category 5e • U.S. Patents 5,606,151 and 5,734,126 • Waterblocked per Telcordia, IEC and ICEA

Plenum • FEP Insulation • Sunlight-, Oil- and Gas-resistant Black FEP Jacket

Plenum • FEP Insulation • Sunlight-, Oil- and Gas-resistant Black FEP Jacket																
EtherNet/IP Compliant High & Low Temp Oil Res I & II Gas Res 	7928A	NEC: Limited Combustible FHC 25/50 CMP CEC: CMP FT6	4	1000	304.8	24.0	10.9	.187	4.75	1	2.0	65.3	63.3	60.8	100±12	20.0
				4	4.0	56.3	52.3	48.7	100±12	23.6						
				8	5.7	51.8	46.1	42.7	100±12	25.4						
				10	6.4	50.3	43.9	40.8	100±12	26.0						
				16	8.1	47.3	39.1	36.7	100±12	26.0						
				25	10.3	44.3	34.1	32.8	100±15	25.5						
				31.25	11.6	42.9	31.3	30.9	100±15	25.0						
				62.5	16.8	38.4	21.6	24.8	100±15	23.5						
				100	21.7	35.3	17.1	20.8	100±15	22.5						
				155	27.7	32.5	4.7	16.9	100±18	19.0						
				200	32.0	30.8	3.0	14.7	100±20	19.0						
250	36.4	29.3	—	12.8	100±20	18.0										
350	44.3	27.2	—	9.9	100±22	17.0										

RJ-45 Compatible
 Cable passes -70°C Cold Bend per UL1581 • Installation Temperature: -55°C to +150°C • Operating Temperature: -70°C to +150°C**
 Jacket sequentially marked at 2 ft. intervals • Third party verified to TIA/EIA-568-B.2, Category 5e • U.S. Patents 5,606,151 and 5,734,126

Polyolefin Insulation • PVC Inner Jacket • .035" Industrial Grade PVC Outer Jacket (Black, Gray, Red, Teal or Blue)

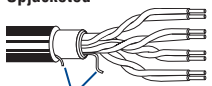
Polyolefin Insulation • PVC Inner Jacket • .035" Industrial Grade PVC Outer Jacket (Black, Gray, Red, Teal or Blue)																
EtherNet/IP Compliant Upjacketed 	11700A	NEC: CMR, CMX- Outdoor CEC: CMR FT4	4	1000	304.8	39.0	17.7	.285	7.24	1	2.0	65.3	63.3	60.8	100±12	20.0
				3000 †	914.4	117.0	53.2	4	4.0	56.3	52.3	48.7	100±12	23.6		
				8	5.7	51.8	46.1	42.7	100±12	25.4						
				10	6.4	50.3	43.9	40.8	100±12	26.0						
				16	8.1	47.3	39.1	36.7	100±12	26.0						
				25	10.3	44.3	34.1	32.8	100±15	25.5						
				31.25	11.6	42.9	31.3	30.9	100±15	25.0						
				62.5	16.8	38.4	21.6	24.8	100±15	23.5						
				100	21.7	35.3	17.1	20.8	100±15	22.5						
				155	27.7	32.5	4.7	16.9	100±18	19.0						
				200	32.0	30.8	3.0	14.7	100±20	19.0						
250	36.4	29.3	—	12.8	100±20	18.0										
350	44.3	27.2	—	9.9	100±22	17.0										

†3000 ft. put-up available in Black only. • Outer jacket is sunlight- and oil-resistant. • Jacket sequentially marked at 2 ft. intervals
 Cable passes -40°C Cold Bend per UL1581 • Installation Temperature: -25°C to +75°C • Operating Temperature: -40°C to +75°C**
 RJ-45 Compatible • Third party verified to TIA/EIA-568-B.2, Category 5e • U.S. Patents 5,606,151 and 5,734,126 • P-07-KA060005-MSHA*

Polyolefin Insulation • PVC Inner Jacket • .035" Industrial Grade PVC Outer Jacket (Black, Gray, Red, Teal or Blue)																
Oil Res I & II Upjacketed 	11700A2 <small>new</small>	NEC: CMR CEC: CMR FT4	4	1000 ††	304.8	42.0	19.1	.285	7.24	1	2.0	65.3	63.3	60.8	100±12	20.0
				2000 ††	609.6	86.0	39.1	4	4.0	56.3	52.3	48.7	100±12	23.0		
				8	5.7	51.8	46.1	42.7	100±12	24.5						
				10	6.4	50.3	43.9	40.8	100±12	25.0						
				16	8.1	47.3	39.1	36.7	100±12	25.0						
				25	10.3	44.3	34.1	32.8	100±15	24.3						
				31.25	11.6	42.9	31.3	30.9	100±15	23.6						
				62.5	16.8	38.4	21.6	24.8	100±15	21.5						
				100	21.7	35.3	17.1	20.8	100±15	20.1						
				155	27.7	32.5	4.7	16.9	100±18	19.0						
				200	32.0	30.8	3.0	14.7	100±20	19.0						
250	36.4	29.3	—	12.8	100±20	18.0										
350	44.3	27.2	—	9.9	100±22	17.0										

††1000 ft. put-up available in Black or Blue only. 2000 ft. put-up in Black only. • RJ-45 Compatible • Outer jacket is sunlight resistant.
 Cable passes -10°C Cold Bend per UL1581 • Installation Temperature: +5°C to +75°C • Operating Temperature: -10°C to +75°C**
 Jacket sequentially marked at 2 ft. intervals • Third party verified to TIA/EIA-568-B.2, Category 5e • U.S. Patents 5,606,151 and 5,734,126

ACR = Attenuation Crosstalk Ratio • BC = Bare Copper • ELFEXT = Equal Level Far-end Crosstalk • NEXT = Near-end Crosstalk • PSUM = Power Sum • RL = Return Loss • TC = Tinned Copper
 *Pennsylvania Department of Environmental Resources and United States Mine Safety and Health Administration Certification. EtherNet/IP is a trademark of ControlNet International, Ltd. under license by Open DeviceNet Vendor Association, Inc.
 **Subject to length de-rating.

DataTuff Color Codes: **Pair 1** = White/Blue Stripe & Blue, **Pair 2** = White/Orange Stripe & Orange, **Pair 3** = White/Green Stripe & Green, **Pair 4** = White/Brown Stripe & Brown
 For two pair products: use color codes for Pairs 2 & 3

Industrial Data Solutions® — Industrial Ethernet

Category 5e DataTuff® Twisted Pair Cables, 2-Pair and 4-Pair Heavy-Duty Sunlight and Oil-Resistant Jackets

Description	Part No.	UL NEC/ C(UL) CEC Type	No. of Pairs	Standard Lengths		Standard Unit Wt.		Nominal OD		Freq. (MHz)	Max. Atten. (dB/100m)	Min. PSUM NEXT (dB)	Min. PSUM ACR (dB/100m)	Min. PSUM ELFEXT (dB/100m)	Input Imped. (Ω)	Min. RL (dB)
				Ft.	m	Lbs.	kg	Inch	mm							

Enhanced Cat 5e • 22 AWG Bonded-Pairs Solid Bare Copper Conductors • Rip Cord • See Color Code Chart (below)

Polyolefin Insulation • .030" Industrial Grade Sunlight- and Oil-resistant Black PVC Jacket

PLTC	7922A <i>new</i>	NEC: PLTC, CMR, CMX- Outdoor CEC: CMR FT4	4	Standard Lengths		Standard Unit Wt.		Nominal OD		1	2.0	65.3	63.3	60.8	100±12	20.0
				1000	304.8	46.3	21.0	.301	7.65							
				2000	609.6	92.5	42.0			4	4.0	56.3	52.3	48.7	100±12	23.0
										8	5.7	51.8	46.1	42.7	100±12	24.5
										10	6.4	50.3	43.9	40.8	100±12	25.0
										16	8.1	47.3	39.1	36.7	100±12	25.0
										25	10.3	44.3	34.1	32.8	100±15	24.3
										31.25	11.6	42.9	31.3	30.9	100±15	23.6
										62.5	16.8	38.4	21.6	24.8	100±15	21.5
										100	21.7	35.3	17.1	20.8	100±15	20.1
										155	27.7	32.5	4.7	16.9	100±18	19.0
										200	32.0	30.8	3.0	14.7	100±20	19.0
										250	36.4	29.3	—	12.8	100±20	18.0
										350	44.3	27.2	—	9.9	100±22	17.0

Cable passes -25°C Cold Bend per UL1581 • Installation Temperature: -10°C to +75°C • Operating Temperature: -25°C to +75°C**
Jacket sequentially marked at 2 ft. intervals • Third party verified to TIA/EIA-568-B.2, Category 5e • U.S. Patents 5,606,151 and 5,734,126

Enhanced Cat 5e • 24 AWG Bonded-Pairs Stranded (7x32) TC Conductors • See Color Code Chart (below)

Polyolefin Insulation • .030" Industrial Grade Sunlight- and Oil-resistant PVC Jacket (Black, Red or Teal)

Stranded Flexible	7924A	NEC: CMR, CMX- Outdoor CEC: CMR FT4	4	Standard Lengths		Standard Unit Wt.		Nominal OD		1	2.4	65.3	62.9	60.8	100±12	20.0
				1000	304.8	30.0	13.6	.242	6.15							
				2000 †	609.6	58.0	26.3			4	4.8	56.3	51.5	48.7	100±12	23.6
										8	6.8	51.8	45.0	42.7	100±12	25.4
										10	7.7	50.3	42.6	40.8	100±12	26.0
										16	9.7	47.3	37.5	36.7	100±12	26.0
										25	12.4	44.3	31.9	32.8	100±15	25.5
										31.25	13.9	42.9	29.0	30.9	100±15	25.0
										62.5	20.2	38.4	18.3	24.8	100±15	23.5
										100	26.0	35.3	9.2	20.8	100±18	22.5
										155	33.2	32.5	—	16.9	100±18	19.0
										200	38.4	30.8	—	14.7	100±20	19.0
										250	43.7	29.3	—	12.8	100±20	18.0
										350	53.2	27.2	—	9.9	100±22	17.0

†2000 ft. put-up available in Black only. • RJ-45 Compatible • Jacket sequentially marked at 2 ft. intervals
Cable passes -40°C Cold Bend per UL1581 • Installation Temperature: -25°C to +75°C • Operating Temperature: -40°C to +75°C**
Third party verified to TIA/EIA-568-B.2, Category 5e • U.S. Patents 5,606,151; 5,734,126 and 5,763,823

Enhanced Cat 5e • 24 AWG Bonded-Pairs Solid BC Conductors • Overall Beldfoil® Shield (100%) • Drain Wire • See Color Codes (below)

Polyolefin Insulation • .030" Industrial Grade Sunlight- and Oil-resistant PVC Jacket (Black, Red or Teal)

EtherNet/IP Compliant Shielded	7933A <i>new</i>	NEC: CMR CEC: CMR FT4	2	Standard Lengths		Standard Unit Wt.		Nominal OD		1	2.0	62.3	60.3	60.8	100±15	20.0
				1000	304.8	32.0	14.5	.227	5.77							
				2000 ▲	609.6	64.8	29.4			4	4.1	53.3	49.2	48.7	100±15	23.6
										10	6.5	47.3	40.8	40.8	100±15	26.0
										16	8.2	44.3	36.1	36.7	100±15	26.0
										31.25	11.7	39.9	28.2	30.9	100±15	25.0
										62.5	17.0	35.4	18.4	24.8	100±15	23.5
										100	22.0	32.3	10.3	20.8	100±15	22.5
										200	32.4	27.8	1.0	14.7	100±25	15.0

*2000 ft. put-up available in Black only. • M-12 or RJ-45 Compatible • Shield is bonded to jacket inner wall for electrical stability.
Cable passes -40°C Cold Bend per UL1581 • Installation Temperature: -25°C to +75°C • Operating Temperature: -40°C to +75°C**
Jacket sequentially marked at 2 ft. intervals • Third party verified to TIA/EIA-568-B.2, Category 5e • U.S. Patents 5,606,151 and 5,734,126

Polyolefin Insulation • .030" Industrial Grade Sunlight- and Oil-resistant PVC Jacket (Black or Blue)

Shielded	7929A	NEC: CMR, CMX- Outdoor CEC: CMR FT4	4	Standard Lengths		Standard Unit Wt.		Nominal OD		1	2.0	62.3	60.3	60.8	100±15	20.0
				1000	304.8	37.0	16.8	.265	6.73							
				2000 ▲	609.6	72.0	32.7			4	4.1	53.3	49.2	48.7	100±15	23.0
										10	6.5	47.3	40.8	40.8	100±15	25.0
										16	8.2	44.3	36.1	36.7	100±15	25.0
										31.25	11.7	39.9	28.2	30.9	100±15	23.6
										62.5	17.0	35.4	18.4	24.8	100±15	21.5
										100	22.0	32.3	10.3	20.8	100±15	20.1
										200	32.4	27.8	1.0	14.7	100±25	15.0

*2000 ft. put-up available in Black only. • RJ-45 Compatible • Shield is bonded to jacket inner wall for electrical stability.
Cable passes -40°C Cold Bend per UL1581 • Installation Temperature: -25°C to +75°C • Operating Temperature: -40°C to +75°C**
Jacket sequentially marked at 2 ft. intervals • Third party verified to TIA/EIA-568-B.2, Category 5e • U.S. Patents 5,606,151 and 5,734,126 • P-07-KA060003-MSHA*

Enhanced Cat 5e • 24 AWG Bonded-Pairs Solid BC Conductors • Overall Beldfoil (100%) + TC Braid Shield (70% Coverage) • Drain Wire*

Polyolefin Insulation • .030" Industrial Grade Sunlight- and Oil-resistant PVC Jacket (Black, Red, Blue or Teal)

EtherNet/IP Compliant Heavy-shielded	7921A	NEC: CMR, CMX- Outdoor CEC: CMR FT4	4	Standard Lengths		Standard Unit Wt.		Nominal OD		1	2.0	62.3	60.3	60.8	100±15	20.0
				1000	304.8	55.0	24.9	.330	8.38							
				2000 ▲	609.6	106.0	48.1			4	4.1	53.3	49.2	48.7	100±15	23.6
										10	6.5	47.3	40.8	40.8	100±15	26.0
										16	8.2	44.3	36.1	36.7	100±15	26.0
										31.25	11.7	39.9	28.2	30.9	100±15	25.0
										62.5	17.0	35.4	18.4	24.8	100±15	23.5
										100	22.0	32.3	10.3	20.8	100±15	22.5

*2000 ft. put-up available in Black only. *24 AWG solid spiral drain wire.
Cable passes -40°C Cold Bend per UL1581 • Installation Temperature: -25°C to +75°C • Operating Temperature: -40°C to +75°C**
Jacket sequentially marked at 2 ft. intervals • Third party verified to TIA/EIA-568-B.2, Category 5e • NEMA WC-63.1 Category 5e • U.S. Patents 5,606,151 and 5,734,126

ACR = Attenuation Crosstalk Ratio • AL = Aluminum • BC = Bare Copper • ELFEXT = Equal Level Far-end Crosstalk • NEXT = Near-end Crosstalk • PSUM = Power Sum • RL = Return Loss • TC = Tinned Copper
EtherNet/IP is a trademark of ControlNet International, Ltd. under license by Open DeviceNet Vendor Association, Inc.

*Pennsylvania Department of Environmental Resources and United States Mine Safety and Health Administration Certification.
**Subject to length de-rating.

DataTuff Color Codes: Pair 1 = White/Blue Stripe & Blue, Pair 2 = White/Orange Stripe & Orange, Pair 3 = White/Green Stripe & Green, Pair 4 = White/Brown Stripe & Brown
For two pair products: use color codes for Pairs 2 & 3



For more information, contact Belden Technical Support: 1-800-BELDEN-1 • www.belden.com

Industrial Data Solutions® — Industrial Ethernet

Category 5e DataTuff® Twisted Pair Cables, 4-Pair Heavy-Duty Sunlight and Oil-Resistant Jackets

Description	Part No.	UL NEC/ C(UL) CEC Type	No. of Pairs	Standard Lengths		Standard Unit Wt.		Nominal OD		Freq. (MHz)	Max. Atten. (dB/100m)	Min. PSUM NEXT (dB)	Min. PSUM ACR (dB/100m)	Min. PSUM ELFEXT (dB/100m)	Input Imped. (Ω)	Min. RL (dB)
				Ft.	m	Lbs.	kg	Inch	mm							

Enhanced Cat 5e • 24 AWG Bonded-Pairs Solid BC Conductors • Polyester Wrap • Rip Cord • See Color Code Chart (below)

AL Interlocked Armor • Polyolefin Insulation • PVC Inner Jacket • .045" Industrial Grade PVC Outer Jacket (Black or Gray)

Interlocked AL Armor	121700A	NEC: CM CEC: HL CMG FT4	4	Standard Lengths		Standard Unit Wt.		Nominal OD		1	2.0	65.3	63.3	60.8	100±12	20.0
				1000	304.8	159.0	72.0	.530	13.46							
				3000 †	914.4	459.0	210.6			8	5.7	51.8	46.1	42.7	100±12	24.5
								Nominal		10	6.4	50.3	43.9	40.8	100±12	25.0
								Core OD:		16	8.1	47.3	39.1	36.7	100±12	25.0
										25	10.3	44.3	34.1	32.8	100±15	24.3
										31.25	11.6	42.9	31.3	30.9	100±15	23.6
										62.5	16.8	38.4	21.6	24.8	100±15	21.5
										100	21.7	35.3	17.1	20.8	100±15	20.1
										155	27.7	32.5	4.7	16.9	100±18	19.0
										200	32.0	30.8	3.0	14.7	100±20	19.0
										250	36.4	29.3	—	12.8	100±20	18.0
										350	44.3	27.2	—	9.9	100±22	17.0

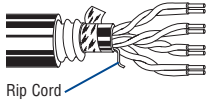

†3000 ft. put-up available in Black only. • RJ-45 Compatible • Outer jacket is sunlight- and oil-resistant.
Cable passes -40°C Cold Bend per UL1581 • Installation Temperature: -25°C to +75°C • Operating Temperature: -40°C to +75°C**
Jacket sequentially marked at 1 meter intervals • Third party verified to TIA/EIA-568-B.2, Category 5e • U.S. Patents 5,606,151 and 5,734,126

AL Interlocked Armor • Polyolefin Insulation • PVC Inner Jacket • .045" Industrial Grade PVC Outer Jacket (Black or Blue)

Interlocked AL Armor -40°C Cold Impact	121700R <i>NEW</i>	NEC: CM CEC: HL CMG FT4	4	Standard Lengths		Standard Unit Wt.		Nominal OD		(Same as above)						
				1000	304.8	159.0	72.0	.530	13.46	1	2.0	62.3	60.3	60.8	100±15	20.0
				3000	914.4	459.0	210.6			4	4.1	53.3	49.2	48.7	100±15	23.0
				5000 †	1524.0	690.0	313.0			10	6.5	47.3	40.8	40.8	100±15	25.0
								Nominal		16	8.2	44.3	36.1	36.7	100±15	25.0
								Core OD:		31.25	11.7	39.9	28.2	30.9	100±15	23.6
										62.5	17.0	35.4	18.4	24.8	100±15	21.5
										100	22.0	32.3	10.3	20.8	100±15	20.1
										200	32.4	27.8	1.0	14.7	100±25	15.0

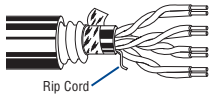

†5000 ft. put-up available in Blue only. • RJ-45 Compatible • Installation Temperature: -25°C to +75°C • Operating Temperature: -40°C to +75°C**
Outer jacket is sunlight- and oil-resistant. • Jacket sequentially marked at 1 meter intervals • Third party verified to TIA/EIA-568-B.2, Category 5e • U.S. Patents 5,606,151 and 5,734,126

Cat 5e • 24 AWG Solid Bare Copper Conductors • Twisted Pairs • Rip Cord • See Color Code Chart (below)

Polyolefin Insulation • .030" Industrial Grade Sunlight- and Oil-resistant PVC Jacket (Black or Blue)

7918A	NEC: CMR, CMX-Outdoor CEC: CMR FT4	4	Standard Lengths		Standard Unit Wt.		Nominal OD		1	2.0	62.3	60.3	60.8	100±15	20.0	
			1000	304.8	28.0	12.7	.230	5.84								4
				2000 ††	609.6	52.0	23.6			10	6.5	47.3	40.8	40.8	100±15	25.0
								Nominal		16	8.2	44.3	36.1	36.7	100±15	25.0
								Core OD:		31.25	11.7	39.9	28.2	30.9	100±15	23.6
										62.5	17.0	35.4	18.4	24.8	100±15	21.5
										100	22.0	32.3	10.3	20.8	100±15	20.1
										200	32.4	27.8	1.0	14.7	100±25	15.0

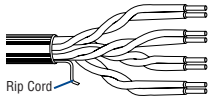

††2000 ft. put-up available in Black only. • RJ-45 Compatible • Jacket sequentially marked at 2 ft. intervals
Cable passes -40°C Cold Bend per UL1581 • Installation Temperature: -25°C to +75°C • Operating Temperature: -40°C to +75°C** • Third party verified to TIA/EIA-568-B.2, Category 5e

Cat 5e • 24 AWG Solid BC • Twisted Pairs • Overall Beldfoil® Shield (100% Coverage) • 24 AWG Stranded TC Drain Wire • See Color Code Chart

Polyolefin Insulation • .030" Industrial Grade Sunlight- and Oil-resistant PVC Jacket (Black or Blue)

Shielded	7919A	NEC: CMR, CMX-Outdoor CEC: CMR FT4	4	Standard Lengths		Standard Unit Wt.		Nominal OD		1	2.0	62.3	60.3	60.8	100±15	20.0
				1000	304.8	35.0	15.9	.265	6.73							
				2000 †	609.6	68.0	30.9			10	6.5	47.3	40.8	40.8	100±15	25.0
								Nominal		16	8.2	44.3	36.1	36.7	100±15	25.0
								Core OD:		31.25	11.7	39.9	28.2	30.9	100±15	23.6
										62.5	17.0	35.4	18.4	24.8	100±15	21.5
										100	22.0	32.3	10.3	20.8	100±15	20.1
										200	32.4	27.8	1.0	14.7	100±25	15.0

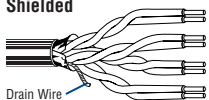

†2000 ft. put-up available in Black only. • RJ-45 Compatible • Installation Temperature: -25°C to +75°C • Operating Temperature: -40°C to +75°C** • Cable passes -40°C Cold Bend per UL1581
Shield is bonded to jacket inner wall for electrical stability. • Jacket sequentially marked at 2 ft. intervals • Third party verified to TIA/EIA-568-B.2, Category 5e • P-07-KA060004-MSHA*

Cat 5e • 24 AWG Stranded (7x32) Bare Copper Conductors • Twisted Pairs • See Color Code Chart (below)

Polyolefin Insulation • .030" Industrial Grade Sunlight- and Oil-resistant Black PVC Jacket

Stranded/Flexible	7930A <i>NEW</i>	NEC: CMR, CMX-Outdoor CEC: CMR FT4	4	Standard Lengths		Standard Unit Wt.		Nominal OD		1	2.5	62.3	59.8	60.8	100±15	20.0
				1000	304.8	29.0	13.2	.240	6.09							
				2000	609.6	56.0	25.4			10	7.8	47.3	39.5	40.8	100±15	25.0
								Nominal		16	9.9	44.3	34.4	36.7	100±15	25.0
								Core OD:		31.25	14.1	39.9	25.8	30.9	100±15	23.6
										62.5	20.4	35.4	15.0	24.8	100±15	21.5
										100	26.4	32.3	5.9	20.8	100±15	20.1
										200	38.9	27.8	—	14.7	100±25	15.0

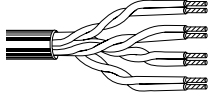

Installation Temperature: 0°C to +75°C • Operating Temperature: -25°C to +75°C** • Cable passes -25°C Cold Bend per UL1581
RJ-45 Compatible • Jacket sequentially marked at 2 ft. intervals • Third party verified to TIA/EIA-568-B.2, Category 5e • P-07-KA060003-MSHA*

ACR = Attenuation Crosstalk Ratio • BC = Bare Copper • ELFEXT = Equal Level Far-end Crosstalk • FEP = Fluorinated Ethylene-propylene • NEXT = Near-end Crosstalk • PSUM = Power Sum • RL = Return Loss • TC = Tinned Copper

EtherNet/IP is a trademark of ControlNet International, Ltd. under license by Open DeviceNet Vendor Association, Inc.

*Pennsylvania Department of Environmental Resources and United States Mine Safety and Health Administration Certification.

**Subject to length de-rating.

Color Codes: DataTuff

Pair No.	Color Combination
1	White/Blue Stripe & Blue
2	White/Orange Stripe & Orange
3	White/Green Stripe & Green
4	White/Brown Stripe & Brown

For two pair products: use color codes for Pairs 2 & 3



Industrial Data Solutions® — Industrial Ethernet

Category 6 DataTuff® Twisted Pair Cables, 4-Pair

Heavy-Duty Jackets

Description	Part No.	UL NEC/ C(UL) CEC Type	No. of Pairs	Standard Lengths		Standard Unit Wt.		Nominal OD		Freq. (MHz)	Max. Atten. (dB/100m)	Min. PSUM NEXT (dB)	Min. PSUM ACR (dB/100m)	Min. PSUM ELFEXT (dB/100m)	Input Imped. (Ω)	Min. RL (dB)
				Ft.	m	Lbs.	kg	Inch	mm							

Enhanced Cat 6 • 23 AWG Bonded-Pairs Solid BC Conductors • Patented E-Spline Center Member • Rip Cord • See Color Code Chart

Polyolefin Insulation • .030" Industrial Grade Sunlight- and Oil-resistant Black PVC Jacket

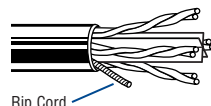
Description	Part No.	UL NEC/ C(UL) CEC Type	No. of Pairs	Standard Lengths		Standard Unit Wt.		Nominal OD		Freq. (MHz)	Max. Atten. (dB/100m)	Min. PSUM NEXT (dB)	Min. PSUM ACR (dB/100m)	Min. PSUM ELFEXT (dB/100m)	Input Imped. (Ω)	Min. RL (dB)		
				Ft.	m	Lbs.	kg	Inch	mm									
	7927A	NEC: CMR CEC: CMR FT4	4	1000	304.8	44.0	20.0	.251	6.38	1	1.9	80.3	78.5	70.8	100±12	20.0		
				2000	609.6	88.0	39.9	x	x	10	5.7	65.3	59.6	50.8	100±12	25.0		
												31.25	10.2	57.9	47.7	40.9	100±15	25.0
												62.5	14.7	53.4	38.7	34.9	100±15	25.0
												100	18.9	50.3	31.4	30.8	100±15	25.0
												155	23.9	47.5	23.5	27.0	100±15	22.8
												200	27.5	45.8	18.3	24.8	100±15	21.7
												250	31.2	44.3	13.2	22.8	100±20	20.5
												350	37.7	40.2	4.5	19.9	100±22	19.8
												400	40.6	39.3	0.6	18.8	100±22	19.5
												500	46.2	37.8	>0.0*	16.8	100±22	18.4
								550	48.8	37.2	—	16.0	100±22	18.0				
								600	51.4	36.6	—	15.2	100±22	17.6				

RJ-45 Compatible • Jacket sequentially marked at 2 ft. intervals • Third party verified to TIA/EIA-568-B.2-1, Category 6
 Cable passes -40°C Cold Bend per UL1581 • Installation Temperature: -25°C to +75°C • Operating Temperature: -40°C to +75°C**
 *PSUM ACR >0 is guaranteed to 460 MHz. • U.S. Patents 5,606,151; 5,734,126; 5,789,711 and 6,297,454-B1

Cat 6 • 23 AWG Bonded-Pairs Solid BC Conductors • See Color Code Chart (below)

Plenum • FEP Insulation • Sunlight-, Oil- and Gas-resistant Black FEP Jacket

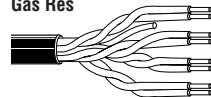
Description	Part No.	UL NEC/ C(UL) CEC Type	No. of Pairs	Standard Lengths		Standard Unit Wt.		Nominal OD		Freq. (MHz)	Max. Atten. (dB/100m)	Min. PSUM NEXT (dB)	Min. PSUM ACR (dB/100m)	Min. PSUM ELFEXT (dB/100m)	Input Imped. (Ω)	Min. RL (dB)			
				Ft.	m	Lbs.	kg	Inch	mm										
	7931A	NEC: Limited CEC: Combustible FHC 25/50 CMP CEC: CMP FT6	4	1000	304.8	35.0	15.9	.214	5.44	1	2.0	72.3	70.3	64.8	100±15	20.0			
												10	6.0	57.3	51.3	44.8	100±15	25.0	
													20	8.5	52.8	44.3	38.7	100±15	25.0
													31.25	10.7	49.9	39.2	34.9	100±15	23.6
													62.5	15.4	45.4	30.0	28.8	100±15	21.5
													100	19.8	42.3	22.5	24.8	100±15	20.1
									200	29.0	37.8	8.8	18.7	100±22	18.0				
									250	32.8	36.3	3.5	16.8	100±32	17.3				

RJ-45 Compatible
 Cable passes -70°C Cold Bend per UL1581 • Installation Temperature: -55°C to +150°C • Operating Temperature: -70°C to +150°C**
 Jacket sequentially marked at 2 ft. intervals • Third party verified to TIA/EIA-568-B.2-1, Category 6 • U.S. Patents 5,606,151 and 5,734,126

Enhanced Cat 6 • 23 AWG Bonded-Pairs Solid BC Conductors • Rip Cord • See Color Code Chart (below)

Polyolefin Insulation • PVC Inner Jacket • .035" Industrial Grade PVC Outer Jacket (Black or Gray)

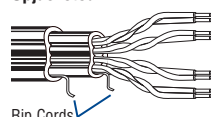
Description	Part No.	UL NEC/ C(UL) CEC Type	No. of Pairs	Standard Lengths		Standard Unit Wt.		Nominal OD		Freq. (MHz)	Max. Atten. (dB/100m)	Min. PSUM NEXT (dB)	Min. PSUM ACR (dB/100m)	Min. PSUM ELFEXT (dB/100m)	Input Imped. (Ω)	Min. RL (dB)			
				Ft.	m	Lbs.	kg	Inch	mm										
	11872A	NEC: CM CEC: FT1	4	1000	304.8	66.0	30.0	.475	12.07	1	1.9	72.3	70	64.8	100±12	20.0			
												4	3.7	63.3	59	52.7	100±12	23.0	
													10	5.9	57.3	51	44.8	100±12	25.0
													16	7.5	54.3	46	40.7	100±12	25.0
													31.25	10.6	49.9	39	34.9	100±15	23.6
													62.5	15.4	45.4	30	28.8	100±15	21.5
													100	19.8	42.3	25	24.8	100±15	21.0
													155	25.1	39.5	14	20.9	100±15	21.0
													200	29.0	37.9	10	18.7	100±15	21.0
													310	37.1	34.9	—	14.9	100±20	18.0
													350	39.8	34.2	—	13.9	100±22	17.0
									400†	43.0	33.3	—	12.7	100±32	14.0				
									500†	49.0	31.8	—	10.8	100±32	14.0				

†Value provided for information only. • RJ-45 Compatible • Cable passes -25°C Cold Bend per UL1581
 Installation Temperature: -10°C to +75°C • Operating Temperature: -25°C to +75°C**
 Jacket sequentially marked at 2 ft. intervals • Verified to TIA/EIA-568-B.2-1, Category 6 • U.S. Patents 5,606,151, 5,734,126 and 5,821,467

Enhanced Cat 6 • 23 AWG Bonded-Pairs Solid BC Conductors • Polyester Wrap • Rip Cord • See Color Code Chart (below)

AL Interlocked Armor • Polyolefin Insulation • PVC Inner Jacket • .055" Industrial Grade PVC Outer Jacket (Black or Gray)

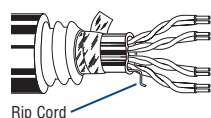
Description	Part No.	UL NEC/ C(UL) CEC Type	No. of Pairs	Standard Lengths		Standard Unit Wt.		Nominal OD		Freq. (MHz)	Max. Atten. (dB/100m)	Min. PSUM NEXT (dB)	Min. PSUM ACR (dB/100m)	Min. PSUM ELFEXT (dB/100m)	Input Imped. (Ω)	Min. RL (dB)			
				Ft.	m	Lbs.	kg	Inch	mm										
	121872A	NEC: HL CEC: CMG FT4	4	1000	304.8	222.0	100.6	.684	17.37	1	1.9	72.3	70	64.8	100±12	20.0			
												4	3.7	63.3	59	52.7	100±12	23.0	
													10	5.9	57.3	51	44.8	100±12	25.0
													16	7.5	54.3	46	40.7	100±12	25.0
													31.25	10.6	49.9	39	34.9	100±15	23.6
													62.5	15.4	45.4	30	28.8	100±15	21.5
													100	19.8	42.3	25	24.8	100±15	21.0
													155	25.1	39.5	14	20.9	100±15	21.0
													200	29.0	37.9	10	18.7	100±15	21.0
													310	37.1	34.9	—	14.9	100±20	18.0
													350	39.8	34.2	—	13.9	100±22	17.0
									400†	43.0	33.3	—	12.7	100±32	14.0				
									500†	49.0	31.8	—	10.8	100±32	14.0				

†Value provided for information only. • RJ-45 Compatible • Jacket sequentially marked at 1 meter intervals
 Cable passes -40°C Cold Bend per UL1581 • Installation Temperature: -25°C to +75°C • Operating Temperature: -40°C to +75°C**
 Verified to TIA/EIA-568-B.2-1, Category 6 • U.S. Patents 5,606,151, 5,734,126 and 5,821,467

ACR = Attenuation Crosstalk Ratio • AL = Aluminum • BC = Bare Copper • ELFEXT = Equal Level Far-end Crosstalk • NEXT = Near-end Crosstalk • PSUM = Power Sum • RL = Return Loss • TC = Tinned Copper
 **Subject to length de-rating.

Color Codes: DataTuff

Pair No.	Color Combination
1	White/Blue Stripe & Blue
2	White/Orange Stripe & Orange
3	White/Green Stripe & Green
4	White/Brown Stripe & Brown

Industrial Data Solutions® — Industrial Ethernet

TrayOptic® Heavy-Duty, All-Dielectric Fiber Optic Cables

Loose Tube — Indoor/Outdoor Riser & Tray

Applications

- Industrial and other harsh environment applications
- Factory automation
- Direct burial

Product Description

Laser Optimized Fiber to handle Gigabit Ethernet light sources and expanded bandwidth requirements. Passes IEEE 383-2003 flame test. Waterblocking agent for moisture protection. CPE outer jacket option provides extra chemical or abrasion resistance.

Jacket Material	PVC or CPE
Strength Member	Aramid Yarn
Jacket Color	Orange

Ratings

Riser	
UL Type	OFNR
cUL Type	OFN FT4
Flame Resistance	IEEE 383-2003

Specifications

Temperature Range	
Storage	-40 to +70°C
Operating	-40 to +70°C
Crush Resistance (EIA-455-41)	500 lbs./in. min.
Impact Resistance (EIA-455-25)	3.3 ft.-lbs./25 impacts min. @ 2.2N-m
Cyclic Flexing (EIA-455-104)	25 cycles, 12 lbs., 20 x OD radius min.
Min. Bend Radius	
Installation	20 x OD
Long Term	15 x OD
Maximum Installation Load	600 lbs. (2700 N)
Optical Specifications	See page 10.2

Fiber Bundle Detail

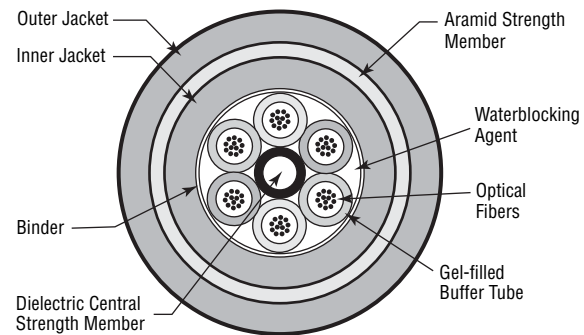

No. of Fibers	Fibers Per Tube	Outside Diameter		PVC Jacket			CPE Jacket		
		Inches	mm	Belden Part No.	Weight Lbs./1000'	Weight kg/km	Belden Part No.	Weight Lbs./1000'	Weight kg/km

TrayOptic Series

Riser (NEC/CEC OFNR/OFN FT4)									
2	2	0.440	11.18	I100255	88	131	I100266	83	124
4	4	0.440	11.18	I100455	88	131	I100466	83	124
6	6	0.440	11.18	I100655	88	131	I100666	83	124
8	4	0.440	11.18	I400855	88	131	I400866	83	124
12	6	0.440	11.18	I601255	88	131	I601266	83	124
18	6	0.440	11.18	I601855	88	131	I601866	83	124
24	6	0.440	11.18	I602455	88	131	I602466	83	124
36	6	0.440	11.18	I603655	88	131	I603666	83	124
48	12	0.540	13.72	I604855	136	202	I604866	129	192
60	12	0.540	13.72	I606055	136	202	I606066	129	192
72	12	0.540	13.72	I607255	136	202	I607266	129	192

All optical fiber products can be supplied in compliance with RoHS regulations. Please contact Customer Service for more details.

Industrial Data Solutions® — Industrial Ethernet

Coaxial Cables

Description	Part No.	UL NEC/ C(UL) CEC Type	Standard Lengths		Standard Unit Weight		Conductor (stranding) Diameter Nom. DCR	Nominal Core OD		Shielding Materials Nom. DCR	Nominal OD		Nom. Imp. (Ω)	Nom. Vel. of Prop.	Nominal Capacitance		Nominal Attenuation		
			Ft.	m	Lbs.	kg		Inch	mm		Inch	mm			pF/Ft.	pF/m	MHz	dB/100 Ft.	dB/100m

Thinnet 10Base2 Ethernet • 20 AWG Stranded (19x32) .037" TC Conductor • Duobond® II (100% Coverage) + TC Braid (93% Coverage)

Foam Polyethylene Insulation • Gray PVC Jacket

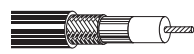
	UL AWM	9907	NEC:	500	152.4	12.5	5.7	20 AWG	.102	2.59	Duobond II	.185	4.70	50	80%	25.4	83.3	1	.43	1.4
	Style 1354		CL2	U-1000	U-304.8	25.0	11.4	(19x32)			+ 93%							10	1.30	4.3
	(30V 60°C)		CM	1000	304.8	25.0	11.4	.037"			TC Braid							50	2.90	9.5
			CEC:	1640	500.0	41.0	18.6	TC			5.8Ω/M'							100	4.20	13.8
			CM	U-2500	U-762.0	60.0	27.3	8.8Ω/M'			19.0Ω/km							200	6.10	20.0
				2500	762.0	62.5	28.4	28.9Ω/km										400	8.90	29.2
			3280	1000.0	82.0	37.3											700	12.10	39.7	
																	900	13.90	45.6	
																	1000	14.80	48.6	

DEC Part No. 17-01248-00

For Plenum versions of 9907, see 89907 or 82907.

Plenum • Foam FEP Insulation • Gray Fluorocopolymer Jacket

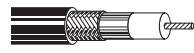
	150°C	89907	NEC:	500	152.4	13.0	5.7	20 AWG	.095	2.41	Duobond II	.160	4.06	50	80%	25.4	83.3	1	.43	1.4	
			CL2P	1000	304.8	24.0	10.9	(19x32)			+ 93%								10	1.30	4.3
			CMP	2500†	762.0	60.0	27.3	.037"			TC Braid								50	2.90	9.5
			CEC:					TC			5.8Ω/M'								100	4.18	13.8
			CMP FT6					8.8Ω/M'			19.0Ω/km								200	6.10	20.0
								28.9Ω/km											400	9.20	30.2
																		700	12.90	42.3	
																		900	15.00	49.2	
																		1000	16.00	52.5	

RG-58/U Type

DEC Part No. 17-01246-00

Suitable for Outdoor and Direct Burial applications.

Thicknet 10Base5 Ethernet • 12 AWG Solid .086" Bare Copper Conductor • Duobond IV* Quad Shield (100% Coverage)

Foam Polyethylene Insulation • Yellow PVC Jacket

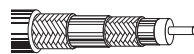
	UL AWM	9880	NEC:	500	152.4	66.0	30.0	12 AWG	.243	6.17	Duobond IV	.405	10.29	50	78%	26.0	85.0	1	.19	.62	
	Style 1478		CL2	1000	304.8	131.0	59.5	(solid)			(Duobond II								5	.37	1.21
	(30V 60°C)		CM	1640	500.0	219.0	99.9	.086"			+ 94% TC Braid								10	.52	1.71
			CEC:					BC			+ Duofoil®								50	1.20	3.94
			CM					1.4Ω/M'			+ 90% TC								100	1.70	5.58
								4.7Ω/km			Braid)								200	2.55	8.37
										1.5Ω/M'								400	3.90	12.80	
										5.0Ω/km								700	5.50	18.10	
																		900	6.50	21.30	
																		1000	6.90	22.60	

DEC Part No. 17-00451-00

Ring-band stripes marked every 2.5 meters to aid users in tap placement.

For Plenum version of 9880, see 89880.

Plenum • Foam FEP Insulation • Orange Fluorocopolymer Jacket

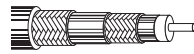
	150°C	89880	NEC:	1000	304.8	134.0	60.9	12 AWG	.245	6.22	Duobond IV	.375	9.53	50	78%	26.0	85.0	1	.18	.59	
			CL2P	1640†	500.0	224.7	102.1	(solid)			(Duobond II								5	.37	max. 1.21
			CMP					.086"			+ 90% TC Braid								10	.52	max. 1.71
			CEC:					BC			+ Duofoil								50	1.15	3.77
			CMP FT6					1.4Ω/M'			+ 90% TC								100	1.65	5.41
								4.7Ω/km			Braid)								200	2.45	8.04
										1.5Ω/M'								400	3.80	12.50	
										5.0Ω/km								700	5.60	18.40	
																		900	6.80	22.30	
																		1000	7.20	23.60	

DEC Part No. 17-00324-00

Ring-band stripes marked every 2.5 meters to aid users in tap placement.

Suitable for Outdoor and Direct Burial applications.

BC = Bare Copper • DCR = DC Resistance • FEP = Fluorinated Ethylene-propylene • TC = Tinned Copper

Contact the Belden Customer Service Department for a Comprehensive Connector Cross Reference. **1-800-BELDEN-1**.

*Duobond IV = Duobond II + 94% tinned copper braid + Duofoil® + 90% tinned copper braid.

(Plenum version is Duobond II + 90% tinned copper braid + Duofoil + 90% tinned copper braid.)

† Spools and/or UnReel® cartons are one piece, but length may vary ±10% from length shown.

Industrial Data Solutions® — Industrial Twinax

Belden® Blue Hose® Selection Guide for PLC and DCS Applications

Part No.	Description	Specifications
9463	Blue Hose Standard Data Highway Cable A Standard Data Highway Cable that is sometimes referred to as Blue Hose. Designed to be used in light industrial environments. Available in Blue, Brown or Orange up to 10,000 ft. special lengths.	1-pair, 20 AWG stranded (7x28) tinned copper, polyethylene insulation (color coded Blue, Clear), Beldfoil® + 55% tinned copper braid and drain wire, Blue sunlight-resistant PVC jacket. Nominal diameter: .238".
3072F	600V Data Highway Cable — UL Type TC A DataTray® cable designed for cable tray use in industrial applications. Cable can occupy same tray or conduit as 600V power cables.	1-pair, 18 AWG stranded (7x26) tinned copper, flame-retardant polyolefin insulation (color coded Blue, White), Beldfoil + 55% tinned copper braid and drain wire, Blue sunlight-resistant PVC jacket. Nominal diameter: .324". UL-1277 600V TC/PLTC/ITC/CMG.
9463F	High-Flex Cable A highly flexible version of the standard Blue Hose cable. The cable also has heavier braid coverage for better noise immunity.	1-pair, 20 AWG stranded (42x36) tinned copper, polyethylene insulation (color coded Blue, Clear), Beldfoil + 85% tinned copper braid, Blue sunlight-resistant PVC jacket. Nominal diameter: .243".
YR28826*	Dual Blue Hose Cable Dual Data Highway/Remote I/O cable has two Twinax pairs individually shielded with an overall braid. Designed for use in daisy chain applications or applications requiring two Blue Hose cables.	2-pair, 20 AWG stranded (7x28) tinned copper, polyethylene insulation (color coded Blue, Clear), each pair Beldfoil shielded (1 pair Blue tape and 1 pair Green tape), 85% tinned copper braid and drain wire, Blue PVC jacket. Nominal diameter: .382".
YC39151*	Dual Armored Data Highway Cable Features two twinax pairs individually shielded with an overall braid, an inner PVC jacket, aluminum interlocked armor, with an outer PVC jacket. Designed for use in daisy chain applications or applications requiring two Blue Hose cables, with the extra mechanical protection and electrical shielding provided by the armor.	2-pair, 20 AWG stranded (7x28) tinned copper, polyethylene insulation (color coded Blue, Clear), each pair Beldfoil shielded, 55% tinned copper braid and drain wire, Blue PVC inner jacket, aluminum interlocked armor, Blue sunlight-resistant PVC outer jacket. Nominal diameter: .820".
9463DB	Gel-Filled Direct Burial Cable A gel-filled Blue Hose cable featuring a low-density polyethylene (LDPE) jacket. Especially suited for high-moisture environments and burial applications.	1-pair, 20 AWG stranded (7x28) tinned copper, polyethylene insulation (color coded Blue, Clear), Beldfoil + 55% tinned copper braid and drain wire, CoreGuard® flooding compound, Blue sunlight-resistant low density polyethylene jacket. Nominal diameter: .240".
89463	Plenum Cable A plenum, 200°C grade cable that is suitable for installations where high and low temperatures, as well as corrosive environments, are encountered.	1-pair, 20 AWG stranded (7x28) tinned copper, FEP insulation (color coded Blue, Clear), Beldfoil + 76% tinned copper braid and drain wire, Blue FEP jacket. Nominal diameter: .203".
YR28764*	Thick-Wall, Heavy-Duty Cable — UL Type PLTC A rugged, heavy-duty cable specially designed for abusive environments. A .069" thick jacket provides extra protection against cuts and abrasion.	1-pair, 20 AWG stranded (7x28) tinned copper, polyethylene insulation (color coded Blue, Clear), Beldfoil + 55% tinned copper braid and drain wire, Blue sunlight-resistant PVC jacket. Nominal diameter: .380".
YR41104*	Low Smoke, Zero Halogen Cable For applications concerned with smoke emissions, toxicity and electronic component corrosion.	1-pair, 20 AWG stranded (7x28) tinned copper, polyethylene insulation (color coded Blue, Clear), Beldfoil + 55% tinned copper braid and drain wire, Blue Haloarrest® jacket. Nominal diameter: .256".
129463	Aluminum Interlocked Armor Blue Hose Cable Features interlocked aluminum armor combined with a PVC jacket and is an ideal alternative to conduit installation. Provides both mechanical protection and electrical shielding. Up to 25 Data Highway cables can be bundled under one sheath.	1-pair, 20 AWG stranded (7x28) tinned copper, polyethylene insulation (color coded Blue, Clear), Beldfoil + 55% tinned copper braid and drain wire, Blue PVC inner jacket, aluminum interlocked armor, Blue PVC sunlight-resistant outer jacket. Nominal overall diameter: .563".
139463	Steel Interlocked Armor Blue Hose Cable Features interlocked galvanized steel armor combined with a PVC jacket. Provides mechanical protection and electrical shielding, as well as prevention against the low-frequency 60 Hz magnetic noise from power lines. Up to 25 cables can be bundled under one sheath.	1-pair, 20 AWG stranded (7x28) tinned copper, polyethylene insulation (color coded Blue, Clear), Beldfoil + 55% tinned copper braid and drain wire, Blue PVC inner jacket, steel interlocked armor, Blue sunlight-resistant outer PVC jacket. Nominal overall diameter: .563".
189463	Continuously Corrugated Aluminum Armor Blue Hose Cable Features continuously corrugated aluminum armor combined with a PVC jacket. Provides mechanical protection, electrical shielding and is impervious to moisture.	1-pair, 20 AWG stranded (7x28) tinned copper, polyethylene insulation (color coded Blue, Clear), Beldfoil + 55% tinned copper braid and drain wire, Blue PVC inner jacket, continuously corrugated aluminum armor, Blue sunlight-resistant PVC outer jacket. Nominal overall diameter: .500".
YR29565*	Colored Blue Hose When your application calls for multiple Blue Hose cables you can rest assured that Belden has the solution. This special construction is available in Red, Yellow, Green, White or Pink.	1-pair, 20 AWG stranded (7x28) tinned copper, polyethylene insulation (color coded Blue, Clear), Beldfoil + 55% tinned copper braid and drain wire, sunlight-resistant PVC jacket. Nominal diameter: .238".

*Custom made product. Minimum order quantity may apply.

Industrial Data Solutions® — Industrial Twinax

Blue Hose® Cables

Description	Part No.	UL NEC/ C(UL) CEC Type	Standard Lengths		Standard Unit Weight		Conductor (stranding) Diameter Nom. DCR	Nominal Core OD		Shielding Materials Nom. DCR	Nominal OD		Nom. Imp. (Ω)	Nom. Vel. of Prop.	Nominal Capacitance		Nominal Attenuation		
			Ft.	m	Lbs.	kg		Inch	mm		Inch	mm			pF/Ft.	pF/m	MHz	dB/100 Ft.	dB/100m

78 Ohm • 20 AWG Stranded (7x28) .038" TC Conductors • Beldfoil® (100% Coverage) + TC Braid Shield (55% Coverage) • TC Drain Wire

Polyethylene Insulation • Blue Sunlight-resistant PVC Jacket (Color Code: Clear, Blue)

Blue Hose	9463	NEC:	100	30.5	4.2	1.9	20 AWG	.154	3.91	Beldfoil	.238	6.05	78	66%	19.7	64.6	1	.6	2.0
UL AWM		CM CL2	U-500	U-152.4	18.5	8.4	(7x28)			+55%							10	2.1	6.9
Style 2464		CEC:	500	152.4	18.5	8.4	.038"			TC Braid							50	5.0	16.4
(300V 80°C)		CM	U-1000	U-304.8	37.0	16.8	Tinned			4.1Ω/M'							100	7.5	24.6
			1000 [▲]	304.8	37.0	16.8	Copper			13.4Ω/km							200	11.0	36.1
			6000 ^{▲†}	1828.8	222.0	100.9	9.5Ω/M'										400	16.0	52.5
			10000 ^{▲†}	3048.0	370.0	168.0	31.0Ω/km												

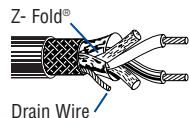

CPE jacket optional.

Allen-Bradley P/N 1770-CD • P-7K-SC-182141-MSHA*

[▲]1000 ft. and 6000 ft. put-ups also available in Brown, Orange or Purple.

[†]10000 ft. put-up available in Brown or Orange only.

[!]Final put-up length may vary ±10% from length shown.

Polyethylene Insulation • Blue Sunlight-resistant LDPE Jacket (Color Code: Clear, Blue)

Flooded Direct Burial Blue Hose	9463DB	—	1000	304.8	33.0	15.0	20 AWG	.154	3.91	Beldfoil	.240	6.10	78	66%	19.7	64.6	1	.6	2.0
300V 80°C			5000	1524.0	155.0	70.4	(7x28)			+55%							10	2.1	6.9
							.038"			TC Braid							50	5.0	16.4
							Tinned			4.1Ω/M'							100	7.5	24.6
							Copper			13.4Ω/km							200	11.0	36.1
							9.5Ω/M'										400	16.0	52.5
							31.0Ω/km												

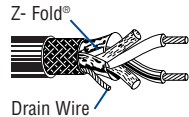

Allen-Bradley P/N 1770-CD

78 Ohm • 20 AWG Stranded (42x36) .038" TC Conductors • Overall Beldfoil (100% Coverage) + TC Braid Shield (85% Coverage)

Polyethylene Insulation • Blue Sunlight-resistant PVC Jacket (Color Code: Clear, Blue)

High-Flex Blue Hose	9463F	NEC:	1000	304.8	42.0	19.1	20 AWG	.154	3.91	Beldfoil	.243	6.17	78	66%	19.7	64.6	1	.6	2.0
300V 60°C		CM CL2	5000	1524.0	205.0	93.1	(42x36)			+85%							10	2.1	6.9
		CEC:					.038"			TC Braid							50	5.0	16.4
		CM					Tinned			5.0Ω/M'							100	7.5	24.6
							Copper			6.4Ω/km							200	11.0	36.1
							9.5Ω/M'										400	16.0	52.5
							31.0Ω/km												



Allen-Bradley P/N 1770-CD • P-7K-SC-182141-MSHA*

78 Ohm • 20 AWG Stranded (7x28) .038" TC Conductors • Overall Beldfoil (100% Coverage) + TC Braid Shield (76% Coverage) • Drain Wire

Plenum • FEP Insulation • Blue FEP Jacket (Color Code: Clear, Blue)

High Temperature Blue Hose	89463	NEC:	1000	304.8	34.0	15.4	20 AWG	.151	3.83	Beldfoil	.203	5.16	78	69%	19.7	64.6	1	.6	2.0
300V 200°C		CMP CL2P	2500	762.0	90.0	40.9	(7x28)			+76%							10	2.1	6.9
		CEC:					.038"			TC Braid							50	5.0	16.4
		CMP FT6					Tinned			4.1Ω/M'							100	7.5	24.6
							Copper			13.4Ω/km							200	11.0	36.1
							9.5Ω/M'										400	16.0	52.5
							31.0Ω/km												

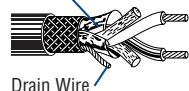

Allen-Bradley P/N 1770-CD

DCR = DC Resistance • FEP = Fluorinated Ethylene-propylene • LDPE = Low-density Polyethylene • TC = Tinned Copper

*Pennsylvania Department of Environmental Resources and United States Mine Safety and Health Administration Certification.

Industrial Data Solutions® — Industrial Twinax

Blue Hose® and Other Twinaxial Cables

Description	Part No.	UL NEC/ C(UL) CEC Type	Standard Lengths		Standard Unit Weight		Conductor (stranding) Diameter Nom. DCR	Nominal Core OD		Shielding Materials Nom. DCR	Nominal OD		Nom. Imp. (Ω)	Nom. Vel. of Prop.	Nominal Capacitance		Nominal Attenuation		
			Ft.	m	Lbs.	kg		Inch	mm		Inch	mm			pF/Ft.	pF/m	MHz	dB/100 Ft.	dB/100m

78 Ohm • 20 AWG Stranded (7x28) TC Conductors • Overall Beldfoil® (100% Coverage) + TC Braid Shield (55% Coverage) • TC Drain Wire

Aluminum Interlocked Armor • PE Insulation • Blue Sunlight-resistant PVC Outer Jacket* (Color Code: Clear, Blue)

Aluminum Armored Blue Hose 300V 60°C 	129463	NEC:	1000†	304.8	122.0	55.5	20 AWG (7x28)	.154	3.91	Beldfoil +55%	Inner Jacket: .238	78	66%	19.7	64.6	1	.6	2.0	
		CM CL2	6000†	1828.8	924.0	420.0	.038"	Tinned	4.1Ω/M'	TC Braid	Overall: .563	14.30					10	2.1	6.9
		CEC:															50	5.0	16.4
		CM, CMG FT4, HLBCD (Haz Loc)															100	7.5	24.6
																	200	11.0	36.1
															400	16.0	52.5		

*Blue PVC inner jacket. Allen-Bradley P/N 1770-CD

Steel Interlocked Armor • PE Insulation • Blue Sunlight-resistant PVC Outer Jacket* (Color Code: Clear, Blue)

Steel Armored Blue Hose 300V 60°C 	139463	NEC:	1000†	304.8	220.0	100.0	20 AWG (7x28)	.154	3.91	Beldfoil +55%	Inner Jacket: .238	78	66%	19.7	64.6	1	.6	2.0	
		CM CL2	6000†	1828.8	1488.0	676.4	.038"	Tinned	4.1Ω/M'	TC Braid	Overall: .563	14.30					10	2.1	6.9
		CEC:															50	5.0	16.4
		CM, CMG FT4, HLBCD (haz loc)															100	7.5	24.6
																	200	11.0	36.1
															400	16.0	52.5		

*Blue PVC inner jacket. Allen-Bradley P/N 1770-CD

Continuously Corrugated AL Armor • PE Insulation • Blue Sunlight-resistant PVC Outer Jacket* (Color Code: Clear, Blue)

Continuously Armored Blue Hose 300V 60°C 	189463	NEC:	2000†	609.6	258.0	117.1	20 AWG (7x28)	.154	3.91	Beldfoil +55%	Inner Jacket: .238	78	66%	19.7	64.6	1	.6	2.0	
		PLTC															10	2.1	6.9
		CEC:															50	5.0	16.4
		CM, CMG FT4, HLBCD (haz loc)															100	7.5	24.6
																	200	11.0	36.1
															400	16.0	52.5		

*Blue PVC inner jacket. Allen-Bradley P/N 1770-CD

78 Ohm • 20 AWG Stranded (7x28) .038" Tinned Copper Conductors • Tinned Copper Braid Shield (93% Coverage)

Polyethylene Insulation • Blue PVC Jacket (Color Code: Clear, Blue)

UL AWM Style 2092 (300V 60°C) 	9272	NEC:	100	30.5	4.5	2.0	20 AWG (7x28)	.156	3.96	93% TC Braid Shield	.244	6.20	78	66%	19.7	64.6	1	.6	2.0
		CM	U-500	U-152.4	20.5	9.3	.038"	Tinned	3.4Ω/M'	11.2Ω/km							10	2.1	6.9
		CEC:	500	152.4	20.0	9.1	.038"										50	5.0	16.4
		CM	U-1000	U-304.8	41.0	18.6											100	7.5	24.6
			1000	304.8	40.0	18.2											200	11.0	36.1
															400	16.0	52.5		

For Plenum version of 9272, see 89272.
CPE jacket optional.

95 Ohm • RG-22B/U Type • 18 AWG Stranded (7x26) Bare Copper Conductors†† • TC Double Braid Shield (95% Coverage)

Polyethylene Insulation • PE Inner Jacket • Black Non-contaminating PVC Outer Jacket

80°C VW-1 	9250	—	500	152.4	61.5	27.9	18 AWG (7x26)	.285	7.24	2 TC Braid Shield	.416	10.57	95	66%	16.0	52.5	1	.3	1.0		
			1000	304.8	121.0	54.9	.046"	BC	6.6Ω/M'	21.5Ω/km	95% Shield							10	.9	3.0	
																			20	1.3	4.3
																			50	2.1	6.9
																			100	3.0	9.8
																		400	6.3	20.7	

††One conductor has tinned center strand.

AL = Aluminum • BC = Bare Copper • DCR = DC Resistance • PE = Polyethylene • TC = Tinned Copper

*Final put-up length may vary ±10% from length shown.

Industrial Data Solutions® — Industrial Twinax

Twinaxial Cables

Description	Part No.	UL NEC/ C(UL) CEC Type	Standard Lengths		Standard Unit Weight		Conductor (stranding) Diameter Nom. DCR	Nominal Core OD		Shielding Materials Nom. DCR	Nominal OD		Nom. Imp. (Ω)	Nom. Vel. of Prop.	Nominal Capacitance		Nominal Attenuation		
			Ft.	m	Lbs.	kg		Inch	mm		Inch	mm			pF/Ft.	pF/m	MHz	dB/100 Ft.	dB/100m

100 Ohm • 20 AWG Stranded (7x28) .037" One TC, One BC Conductor • Duofoil® (100% Coverage) + TC Braid Shield (86% Coverage)

Polyethylene Insulation • Polyethylene Inner Jacket • Black PVC Outer Jacket

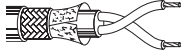
75°C	9207	NEC:	100	30.5	7.1	3.2	20 AWG	.236	5.99	Duofoil	.330	8.38	100	66%	14.5	47.6	1	.3	1.0
		CMG CL2	U-500	U-152.4	34.0	15.5	(7x28)			+ 86%							10	1.2	3.9
		CEC:	500	152.4	34.5	15.7	.037"			TC Braid							50	2.8	9.2
		CMG FT4	1000	304.8	68.0	30.9	1 TC			2.5Ω/M'							100	4.1	13.5
			1640	500.0	111.5	50.7	1 BC			8.2Ω/km							200	6.4	21.0
			2000	609.6	136.0	61.8	9.5Ω/M'										400	10.2	33.5
			3280	1000.0	219.8	99.9	31.0Ω/km												
			5000	1524.0	350.0	159.1													

IBM P/N 7362211

For Plenum version of 9207, see 89207.
CPE jacket optional.

124 Ohm • 25 AWG Stranded (7x33) .021" Tinned Copper Conductors • Beldfoil® (100% Coverage) • Stranded Tinned Copper Drain Wire

Polyethylene Insulation • Blue PVC Jacket (Color Code: Clear, Blue)

UL AWM	9271	NEC:	100	30.5	3.2	1.5	25 AWG	.170	4.32	100%	.240	6.10	124	66%	12.2	40.0	1	.6	2.0
Style 2092		CM	500	152.4	14.0	6.4	(7x33)			Beldfoil							10	1.7	5.6
(300V 60°C)		CEC:	U-1000	U-304.8	27.0	12.3	.021"			Shield							50	3.6	11.8
		CM	1000	304.8	28.0	12.7	Tinned			12.0Ω/M'							100	5.0	16.4
							Copper			39.4Ω/km							200	6.9	22.6
							31.8Ω/M'										400	9.6	31.5
							104.3Ω/km												

Shorting Fold

CPE jacket optional.

124 Ohm • 16 AWG Solid .051" Bare Copper Conductors • Duofoil (100% Coverage) + Tinned Copper Braid Shield (90% Coverage)

Foam Polyethylene Insulation • Black PVC Jacket (Color Code: Clear, Blue)

UL AWM	9860	NEC:	500	152.4	52.0	23.6	16 AWG	.322	8.18	Duofoil	.440	11.18	124	78%	10.9	35.8	1	.2	.6
Style 2448		CMX	1000	304.8	103.0	46.8	(solid)			+90%							10	.7	2.3
(30V 60°C)		CEC:	2000	609.6	202.0	91.8	.051"			TC Braid							50	1.8	5.9
		CMX					Bare			1.3Ω/M'							100	2.9	9.5
							Copper			4.3Ω/km							200	4.1	13.5
							4.2Ω/M'										400	6.2	20.3
							13.8Ω/km												

CPE jacket optional.

150 Ohm • 22 AWG Stranded (19x34) .031" Tinned Copper Conductors • Duofoil (100% Coverage) • Stranded Tinned Copper Drain Wire

Datalene® Insulation • Black PVC Jacket (Color Code: Black, Yellow)

UL AWM	9182	NEC:	U-500	U-152.4	22.5	10.2	22 AWG	.275	6.98	100%	.345	8.76	150	78%	8.8	28.9	1	.4	1.3
Style 2668		CL2X CMX	500	152.4	23.0	10.4	(19x34)			Duofoil							10	1.2	3.9
(30V 60°C)		CEC:	1000	304.8	44.0	20.0	.031"			Shield							50	2.7	8.9
VW-1		CMX					Tinned			6.3Ω/M'							100	4.3	14.1
							Copper			20.7Ω/km							200	6.2	20.3
							14.0Ω/M'										400	8.8	28.9
							45.9Ω/km												

Dual version: YR41609

CPE jacket optional.

Plenum • Foam FEP Teflon® Insulation • Black FEP Teflon Jacket (Color Code: Black, Yellow)

	89182	NEC:	100	30.5	6.4	2.9	22 AWG	.278	7.06	100%	.307	7.80	150	78%	8.8	28.9	1	.4	1.3
		CMP	500†	152.4	28.0	12.7	(19x34)			Duofoil							10	1.2	3.9
		CL2P	1000†	304.8	53.0	24.1	.031"			Shield							50	2.7	8.9
		CEC:					Tinned			6.3Ω/M'							100	4.3	14.1
		CMP FT6					Copper			20.7Ω/km							200	6.2	20.3
							14.0Ω/M'										400	8.8	28.9
							45.9Ω/km												

BC = Bare Copper • DCR = DC Resistance • FEP = Fluorinated Ethylene-propylene • TC = Tinned Copper

†Spools are one piece, but length may vary ±10% from length shown.

Teflon is a DuPont trademark.

Industrial Data Solutions® — Industrial Twinax

DataTray® 600V Twinaxial Cables

Description	Part No.	UL NEC/ C(UL) CEC Type	Standard Lengths		Standard Unit Weight		Conductor (stranding) Diameter Nom. DCR	Nominal Core OD		Shielding Materials Nom. DCR	Nominal OD		Nom. Imp. (Ω)	Nom. Vel. of Prop.	Nominal Capacitance		Nominal Attenuation			
			Ft.	m	Lbs.	kg		Inch	mm		Inch	mm			pF/Ft.	pF/m	MHz	dB/ 100 Ft.	dB/ 100m	
18 AWG Stranded (7x26) Tinned Copper Conductors • Overall Beldfoil® (100% Coverage) + TC Braid Shield (55% Coverage) • TC Drain Wire Flame-retardant Polyolefin Insulation • Blue Sunlight-resistant PVC Jacket (Color Code: Natural, Blue)																				
UL Type TC 600V 75°C Z-Fold® Drain Wire P-MSHA-C-7K-1827*	3072F	NEC:	250	76.2	17.5	8.0	18 AWG (7x26)	.192	4.88	Beldfoil +55%	.324	8.23	78	65%	19.5	64	1	.5	1.7	
		CMG, ITC	500	152.4	35.0	15.9												10	2.0	6.5
		TC, PLTC	1000	304.8	69.0	31.3	.046"				TC Braid (100% Shield)							50	3.8	12.4
		CEC:	2500	762.0	170.0	77.2		Tinned Copper										100	5.4	17.6
		CMG FT4	5000†	1524.0	345.0	156.6												200	7.6	24.8
			10000†	3048.0	710.0	322.3	6.9Ω/M'			3.2Ω/M'							400	10.7	35.1	
							22.7Ω/km			10.4Ω/km							For CPE jacketed version order Part No. YM45044.			
UL Type TC 600V 75°C Z-Fold® Drain Wire	3073F	NEC:	250	76.2	21.0	9.5	18 AWG (7x26)	.246	6.25	Beldfoil +55%	.388	9.86	100	65%	15.3	50.2	1	.4	1.3	
		CMG, ITC	1000	304.8	85.0	38.6												10	1.3	4.4
		TC, PLTC	5000†	1524.0	420.0	190.7	.046"				TC Braid (100% Shield)							50	3.0	9.7
		CEC:						Tinned Copper										100	4.2	13.8
		CMG FT4																200	6.0	19.5
							6.9Ω/M'			2.9Ω/M'							400	7.5	24.7	
							22.7Ω/km			9.6Ω/km							CPE jacket optional.			
UL Type TC 600V 75°C Z-Fold® Drain Wire	3074F	NEC:	500	152.4	62.5	28.4	18 AWG (7x26)	.328	8.33	Beldfoil +55%	.460	11.68	124	65%	12.3	40.3	1	.3	1.1	
		CMG, ITC	1000	304.8	121.0	54.9												10	1.1	3.5
		TC, PLTC	2500	762.0	300.0	136.2	.046"				TC Braid (100% Shield)							50	2.4	7.8
		CEC:						Tinned Copper										100	3.4	11.1
		CMG FT4																200	4.8	15.7
							6.9Ω/M'			2.8Ω/M'							400	6.8	22.2	
							22.7Ω/km			9.1Ω/km							CPE jacket optional.			

DCR = DC Resistance • TC = Tinned Copper if conductor, or Tray Cable if NEC rating.

*Pennsylvania Department of Environmental Resources and United States Mine Safety and Health Administration certification.

†Final put-up length may vary -0 to +10% from length shown.

Industrial Data Solutions® — Industrial Coax

ControlNet™ Quad Shielded Coax

Description	Part No.	UL NEC/ C(UL) CEC Type	Standard Lengths		Standard Unit Weight		Conductor (stranding) Diameter Nom. DCR	Nominal Core OD		Shielding Materials Nom. DCR	Nominal OD		Nom. Imp. (Ω)	Nom. Vel. of Prop.	Nominal Capacitance		Nominal Attenuation		
			Ft.	m	Lbs.	kg		Inch	mm		Inch	mm			pF/Ft.	pF/m	MHz	dB/ 100 Ft.	dB/ 100m

RG-6/U Type • 18 AWG Solid Bare Copper-covered Steel Conductor • Duobond® IV* Quad Shield (100% Coverage)

Foam Polyethylene Insulation • PVC Jacket (Black or Intrinsically Safe Blue)

	3092A	NEC:	500	152.4	20.0	9.1	18 AWG	.180	4.57	Duobond IV	.298	7.57	75	82%	16.2	53.1	1	.35	1.1
		CL2R CMR	1000	304.8	39.0	17.7	(solid)			Quad							2	.38	1.2
		CEC:	2000	609.6	78.0	35.4	.040"			Shield							5	.45	1.5
		CMG FT4	2500	762.2	92.5	42.0	BCCS			3.6Ω/M'							10	.59	1.9
							28.0Ω/M'			11.8Ω/km					Sweep tested 5 MHz to 50 MHz.		20	.86	2.8
						91.8Ω/km								CPE jacket optional.		50	1.37	4.5	
																100	1.97	6.5	
																200	2.82	9.3	
																300	3.48	11.4	
																400	4.04	13.3	

Allen-Bradley P/N 1786

Plenum • Foam FEP Insulation • Fluorocopolymer Jacket (Black or Intrinsically Safe Blue*)

	3093A	NEC:	1000*	304.8	40.0	18.2	18 AWG	.170	4.32	Duobond IV	.274	6.96	75	82%	16.3	53.5	1	.36	1.2
		CMP	2000†	609.6	80.0	36.3	(solid)			Quad							2	.38	1.2
		CEC:	2500†	762.0	95.0	43.1	.040"			Shield							5	.50	1.6
		CMG FT6					BCCS			3.6Ω/M'							10	.65	2.1
							28.0Ω/M'			11.8Ω/km					Sweep tested 5 MHz to 50 MHz.		20	.95	3.1
						91.8Ω/km										50	1.50	4.9	
																100	2.12	7.0	
																200	2.99	9.8	
																300	3.66	12.0	
																400	4.23	13.9	

*Blue available as standard in 1000 ft. only.

Suitable for Outdoor and Direct Burial applications. • Allen-Bradley P/N 1786

RG-6/U Type • 20 AWG Stranded (105x40) Bare Copper Conductor • Duobond IV* Quad Shield (100% Coverage)

Foam Polyethylene Insulation • Black PVC Jacket

	3092F	NEC:	1000	304.8	44.0	20.0	20 AWG	.183	4.65	Duobond IV	.303	7.70	75	79%	17.0	55.8	1	.36	1.2
		CL2R CMR	5000	1524.0	220.0	99.8	(105x40)			Quad							2	.47	1.5
		CEC:					.040"			Shield							5	.80	2.6
		CMG FT4					Bare			3.6Ω/M'					Sweep tested 5 MHz to 400 MHz.		10	1.20	3.9
							Copper			11.8Ω/km					CPE jacket optional.		20	2.00	6.6
						10.5Ω/M'										50	3.20	10.5	
						34.4Ω/km										100	4.60	15.1	
																200	6.50	21.3	
																300	8.00	26.2	
																400	9.30	30.5	

IEEE 802.4 MAP/IEEE 802.7 Mini-MAP. • Allen-Bradley P/N 1786

For Rockwell authorized Flexible ControlNet order YR28890 (Tinned Copper Braid version).

RG-6/U Type • 18 AWG Solid Bare Copper-Covered Steel Conductor • Duobond IV* Quad Shield (100% Coverage)

Aluminum Interlocked Armor • Foam Polyethylene Insulation • PVC Inner Jacket • Black PVC Sunlight Resistant Outer Jacket

	123092A	NEC:	1000††	304.8	180.0	81.7	18 AWG	.180	4.57	Duobond IV	Inner Jacket	75	82%	16.2	53.2	1	.35	1.2
	new	CM					(solid)			Quad	.298	7.57				2	.38	1.3
		CEC:					.040"			Shield	Overall:					5	.45	1.5
		CMG, FT4, HL					BCCS			3.6Ω/M'	.620	15.75				10	.59	1.9
							28.0Ω/M'			11.8Ω/km					Sweep tested 5 MHz to 50 MHz.		20	.86
						91.9Ω/km								CPE jacket optional.		50	1.37	4.5
																100	1.97	6.5
																200	2.82	9.3
																300	3.48	11.4
																400	4.04	13.3

Allen-Bradley P/N 1786

Jacket sequentially marked at 1 meter intervals.

Continuously Corrugated Aluminum Armor • Foam Polyethylene Insulation • PVC Inner Jacket • Black PVC Outer Jacket

	183092A	NEC:	2000^	609.6	350.0	158.9	18 AWG	.180	4.57	Duobond IV	Inner Jacket	75	82%	16.2	53.2	1	.35	1.2
	new	CL2, CM					(solid)			Quad	.298	7.57				2	.38	1.3
							.040"			Shield	Overall:					5	.45	1.5
							BCCS			3.6Ω/M'	.570	14.48				10	.59	1.9
							28.0Ω/M'			11.8Ω/km					Sweep tested 5 MHz to 50 MHz.		20	.86
						91.9Ω/km										50	1.37	4.5
																100	1.97	6.5
																200	2.82	9.3
																300	3.48	11.4
																400	4.04	13.3

Allen-Bradley P/N 1786

Jacket sequentially marked at 2 ft. intervals.

BCCS = Bare Copper-covered Steel • DCR = DC Resistance • FEP = Fluorinated Ethylene-propylene

*Duobond IV Quad Shield = Duobond II Foil + 60% aluminum braid + Duofoil + 40% aluminum braid.

†Final put-up length may vary 0 to +10% from length shown.

††Final put-up length may vary ±5% from length shown.

*Final put-up length may vary ±10% from length shown.

ControlNet is a ControlNet International trademark.

Industrial Data Solutions® — Industrial Coax

ControlBus™ Quad Shielded Coax

Description	Part No.	UL NEC/ C(UL) CEC Type	Standard Lengths		Standard Unit Weight		Conductor (stranding) Diameter Nom. DCR	Nominal Core OD		Shielding Materials Nom. DCR	Nominal OD		Nom. Imp. (Ω)	Nom. Vel. of Prop.	Nominal Capacitance		Nominal Attenuation			
			Ft.	m	Lbs.	kg		Inch	mm		Inch	mm			pF/Ft.	pF/m	MHz	dB/100 Ft.	dB/100m	
RG-6/U Type • 20 AWG Stranded (105x40) Bare Copper Conductor • Duobond® IV* Quad Shield (100% Coverage)																				
Foam Polyethylene Insulation • Black PVC Jacket																				
	High-Flex	3092F	NEC:	1000	304.8	44.0	20.0	20 AWG (105x40) .040" Bare Copper 10.5Ω/M' 34.4Ω/km	.183	4.65	Duobond IV Quad Shield 3.6Ω/M' 11.8Ω/km	.303	7.70	75	79%	17.0	55.8	1	.36	1.2
			CL2R CMR	5000	1524.0	225.0	102.2											2	.47	1.5
			CEC:															5	.80	2.6
			CMG															10	1.20	3.9
			FT4															20	2.00	6.6
																		50	3.20	10.5
																		100	4.60	15.1
																		200	6.50	21.3
																		300	8.00	26.2
																		400	9.30	30.5

IEEE 802.4 MAP/IEEE 802.7 Mini-MAP.

RG-6/U Type • 18 AWG Solid Bare Copper-covered Steel Conductor • Duobond IV* Quad Shield (100% Coverage)

Gas-Injected Foam Polyethylene Insulation • Gray PVC Jacket																			
	3131A	NEC:	1000	304.8	41.0	18.6	18 AWG (solid) .040" BCCS 28.0Ω/M' 91.8Ω/km	.180	4.57	Duobond IV Quad Shield 3.6Ω/M' 11.8Ω/km	.300	7.62	75	82%	16.2	53.1	1	.35	1.1
		CL2R CMR	2500	762.0	100.0	45.4											2	.38	1.2
		CEC:															5	.45	1.5
		CMR FT4															10	.59	1.9
																	20	.86	2.8
																	50	1.37	4.5
																	100	1.97	6.5
																	200	2.82	9.3
																	300	3.48	11.4
																	400	4.04	13.3

IEEE 802.4 MAP/IEEE 802.7 Mini-MAP.
Tap marks every 2.6 meters to aid users in installation.

Plenum • Foam FEP Insulation • Gray Fluorocopolymer Jacket																				
	150°C	3132A	NEC:	1000	304.8	36.0	16.3	18 AWG (solid) .040" BCCS 28.0Ω/M' 91.8Ω/km	.170	4.32	Duobond IV Quad Shield 3.6Ω/M' 11.8Ω/km	.274	6.96	75	82%	16.3	53.5	1	.36	1.2
			CMP															2	.38	1.2
			CEC:															5	.50	1.6
			CMP FT6															10	.65	2.1
																		20	.95	3.1
																		50	1.50	4.9
																		100	2.12	7.0
																		200	2.99	9.8
																		300	3.66	12.0
																		400	4.23	13.9

IEEE 802.4 MAP/IEEE 802.7 Mini-MAP.
Tap marks every 2.6 meters to aid users in installation.
Suitable for Outdoor and Direct Burial applications.

RG-11/U Type • 14 AWG Solid Bare Copper-covered Steel Conductor • Duobond IV* Quad Shield (100% Coverage)

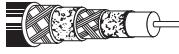
Gas-Injected Foam Polyethylene Insulation • Gray PVC Jacket																			
	3094A	NEC:	500	152.4	35.5	16.1	14 AWG (solid) .064" BCCS 11.0Ω/M' 36.1Ω/km	.280	7.11	Duobond IV Quad Shield 1.5Ω/M' 4.9Ω/km	.407	10.34	75	82%	16.2	53.1	1	.16	.5
		CL2R CMR	1000	304.8	62.0	28.1											2	.18	.6
		CEC:	2000	609.6	140.0	63.6											5	.26	.9
		CMG FT4															10	.38	1.2
																	20	.55	1.8
																	50	.83	2.7
																	100	1.17	3.8
																	200	1.60	5.3
																	300	1.99	6.5
																	400	2.30	7.5

IEEE 802.4 MAP
Tap marks every 2.6 meters to aid users in installation.

Plenum • Foam FEP Insulation • Gray Fluorocopolymer Jacket																				
	150°C	3095A	NEC:	1000	304.8	76.0	34.5	14 AWG (solid) .064" BCCS 11.0Ω/M' 36.1Ω/km	.280	7.11	Duobond IV Quad Shield 3.9Ω/M' 12.8Ω/km	.387	9.83	75	82%	16.5	54.1	1	.17	.6
			CMP															2	.22	.7
			CEC:															5	.28	.9
			CMP FT6															10	.40	1.3
																		20	.60	2.0
																		50	1.20	3.9
																		100	1.70	5.6
																		200	2.50	8.2
																		300	3.04	10.0
																		400	3.50	11.5

IEEE 802.4 MAP
Tap marks every 2.6 meters to aid users in installation.
Suitable for Outdoor and Direct Burial applications.

BCCS = Bare Copper-covered Steel • DCR = DC Resistance • FEP = Fluorinated Ethylene-propylene
*Duobond IV Quad Shield = Duobond II Foil + 60% aluminum braid + Duofoil® + 40% aluminum braid.

Industrial Data Solutions® — Industrial Data

DataBus® ISA/SP-50 FOUNDATION Fieldbus or PROFIBUS Cables

Description	Part No.	UL NEC/ C(UL) CEC Type	Standard Lengths		Standard Unit Weight		Conductor (stranding) Diameter Nom. DCR	Nominal Core OD		Shielding Materials Nom. DCR	Nominal OD		Nom. Imp. (Ω)	Nom. Vel. of Prop.	Nominal Capacitance		Nominal Attenuation	
			Ft.	m	Lbs.	kg		Inch	mm		Inch	mm			pF/Ft.	pF/m	MHz	dB/100 Ft.

FOUNDATION Fieldbus/PROFIBUS PA • 18 AWG Stranded (7x26) TC Conductors • Beldfoil® Shield (100% Coverage) • TC Drain Wire

Polyolefin Insulation • Orange or Blue PVC Jacket (Color Code: Blue, Orange)

Type A	3076F	NEC:	250	76.2	10.5	4.8	(2) 18 AWG	.088	2.24	100%	.253	6.43	100 @	66%	24.0	78.7	.039	.08	.26
300V 105°C (31.25 KBits/sec)		PLTC CM	500	152.4	18.5	8.4	(7x26)			Beldfoil				31.25 KHz					
		ITC	1000	304.8	37.0	16.8	.048"			Shield									
		CEC:	2500	762.0	85.0	38.6	Tinned			7.5Ω/M'									
		CM	5000†	1524.0	170.0	77.2	Copper			24.6Ω/km									
							7.5Ω/M'												
							24.6Ω/km												

123076F — Version with Aluminum Interlocked Armor
 133076F — Version with Steel Interlocked Armor
 YM47023 — CPE jacketed version
 YM46698 — Black & White color-coded pairs
 YM47090 — Various colored jackets
 YM41725 — LSZH (FRNC) jacketed version



Fieldbus: Orange jacket. Profibus PA: Intrinsically Safe Blue jacket. Blue available as standard in 1000 ft. put-up only.

FOUNDATION Fieldbus • 22 AWG Stranded (7x30) TC Conductors • Beldfoil Shield (100% Coverage) • Tinned Copper Drain Wire

Polyolefin Insulation • Orange PVC Jacket (Color Code: Blue, Orange)

Type B	3077F	NEC:	500†	152.4	11.0	5.0	(2) 22 AWG	.059	1.50	100%	.196	4.97	100 @	66%	23.5	77.1	.039	.14	.45
300V 105°C (31.25 KBits/sec)		PLTC CM	1000†	304.8	23.0	10.4	(7x30)			Beldfoil				31.25 KHz					
		ITC					.030"			Shield									
		CEC:					Tinned			11.4Ω/M'									
		CM					Copper			37.4Ω/km									
							17.1Ω/M'												
							56.0Ω/km												

123077F — Version with Aluminum Interlocked Armor
 133077F — Version with Steel Interlocked Armor
 CPE and LSZH jacketed versions also available.



FHDPE Insulation • Orange PVC Jacket (Color Code: Blue, Orange)

High Speed▲	3078F	NEC:	250	76.2	10.0	4.5	(2) 22 AWG	.121	3.07	100%	.351	8.92	150 @	78%	8.5	27.9	.250	.18	.59
300V 75°C (1.0 & 2.5 MBits/sec)		PLTC CM	500	152.4	23.0	10.4	(7x30)			Beldfoil				1 MHz			.625	.26	.85
		ITC					.030"			Shield							1.250	.34	1.12
		CEC:	1000	304.8	44.0	20.0	.030"			3.3Ω/M'							3.125	.55	1.81
		CM	2500	762.0	115.0	52.2	Tinned			11.1Ω/km									
							Copper												
							17.1Ω/M'												
							56.1Ω/km												

123078F — Version with Aluminum Interlocked Armor
 133078F — Version with Steel Interlocked Armor
 CPE and LSZH jacketed versions also available.



PROFIBUS DP • 22 AWG Solid Bare Copper Conductors • Beldfoil (100% Coverage) + Tinned Copper Braid Shield (65% Coverage)

FHDPE Insulation • Chrome or Purple PVC Jacket (Color Code: Red, Green)

300V 75°C	3079A	NEC:	1000	304.8	56.0	25.4	(2) 22 AWG	.099	2.52	Beldfoil	.315	8.00	150	78%	8.5	27.9	.2	.27	.9
		PLTC CMG	2000	609.6	112.0	50.8	(solid)			+ 65%							4.0	.67	2.2
		CEC:	3600	1097.6	201.6	91.4	.026"			TC Braid							16.0	1.37	4.5
		CMG FT4					Bare			Shield							100.0	3.75	12.3
							Copper			(100%							300.0	6.52	21.4
							16.0Ω/M'			Coverage)									
							52.5Ω/km			3.9Ω/M'									
										12.8Ω/km									

123079A — Aluminum Interlocked Armor
 133079A — Steel Interlocked Armor
 YR45047 — CPE jacketed version
 YR44731 — LSZH (FRNC) jacketed version

UL AWM 20201 (600V)
 Siemens Sinec L2 cable.

PROFIBUS DP • 22 AWG Stranded (7x30) Bare Copper Conductors • Beldfoil (100% Coverage) + TC Braid Shield (65% Coverage)

FR-FPE Insulation • Purple PVC Jacket (Color Code: Red, Green)

300V 75°C	3079E	NEC:	1000	304.8	44.0	20.0	(2) 22 AWG	.099	2.52	Beldfoil	.315	8.00	150	78%	8.5	27.9	.2	.34	1.1
		PLTC CMG	1640	500.0	73.8	33.5	Stranded			+ 65%							4.0	.81	2.7
		CEC:	3280	1000.0	144.3	65.5	(7x30)			TC Braid							16.0	1.64	5.4
		CMG FT4					Bare			Shield									
							Copper			(100%									
							16.0Ω/M'			Coverage)									
							52.5Ω/km			3.9Ω/M'									
										12.8Ω/km									

DCR = DC Resistance • FHDPE = Foamed High-Density Polyethylene • FR-FPE = Flame-Retardant Polyethylene • FRNC = Flame-Retardant Non-Corrosive • LSZH = Low-Smoke Zero-Halogen • TC = Tinned Copper
 †Final put-up length may vary -0 to +10% from length shown.

▲ For HSE, see Industrial Ethernet Section for copper and fiber cables.

Industrial Data Solutions® — Industrial Data

DeviceBus® for ODVA DeviceNet™

DeviceNet Communications Rate Table

Communications Rate	Maximum Distance																			
	3082A		3082F		3082K		3083A		3084F		3084A/3085A		7895A		7896A		7897A		7900A	
	Ft.	m	Ft.	m	Ft.	m	Ft.	m	Ft.	m	Ft.	m	Ft.	m	Ft.	m	Ft.	m	Ft.	m
125 Kbps	1640	500	1640	500	1378	420	1640	500	328	100	328	100	984	300	1378	420	1640	500	328	100
250 Kbps	820	250	820	250	656	200	820	250	328	100	328	100	820	250	656	200	820	250	328	100
500 Kbps	328	100	328	100	246	75	328	100	328	100	328	100	328	100	328	100	328	100	328	100

Description	Part No.	UL NEC/ C(UL) CEC Type	Standard Lengths		Standard Unit Weight		Conductor (stranding) Diameter Nom. DCR	Shielding Materials Nom. DCR	Color Code	Nominal OD		Nom. Imp. (Ω)	Nom. Vel. of Prop.	Nominal Capacitance		Nominal Attenuation		
			Ft.	m	Lbs.	kg				Inch	mm			pF/Ft.	pF/m	MHz	dB/ 100 Ft.	dB/ 100m

600V Class 1 Thick • 15 and 18 AWG Stranded TC Conductors • Individually Foil Shielded (100% Coverage) + Overall TC Braid (65% Coverage)

PVC/Nylon Insulation (Power) • FEP Insulation (Data) • Gray Sunlight/Oil-resistant PVC Jacket

High Velocity Thick 600V 75°C	7897A	NEC:	500	152.4	69.5	31.6	(2)15 AWG TC	100%	Power Pair:	.460	11.7	—	—	—	—	—	—	—	—	—
		TC-ER	1000	304.8	135.0	61.3	(19x28)	Individual	Red&Black											
			2000	609.6	274.0	124.4	3.6Ω/M'	Foil												
								11.8Ω/km	+ Overall											
						(2)18 AWG TC	65%	Data Pair:			120	75%	12.0	39.4	.125	.13	.43			
						(19x30)	TC Braid	Blue&White							.500	.25	.82			
						6.9Ω/M'	1.8Ω/M'								1.000	.40	1.31			
						22.6Ω/km	5.9Ω/km													

18 AWG stranded (19x30) tinned copper drain wire.
Meter marks on jacket to aid users in installation.
Allen-Bradley P/N 1485 CPI-A

600V Class 1 ODVA Cable V • 16 and 18 AWG Stranded TC Cond. • Individ. Foil Shielded (100% Coverage) + Overall TC Braid (65% Coverage)

PVC/Nylon Insulation (Power) • F-R Polypropylene Insulation (Data) • Gray Sunlight/Oil-resistant PVC Jacket

600V 75°C	7896A	NEC:	500	152.4	89.0	40.4	(2)16 AWG TC	100%	Power Pair:	.525	13.34	—	—	—	—	—	—	—	—
		TC-ER	1000	304.8	168.0	76.2	(19x29)	Individual	Red&Black										
			2000	609.6	340.0	154.2	4.9Ω/M'	Foil											
								16.1Ω/km	+ Overall										
						(2)18 AWG TC	65%	Data Pair:			120	64%	14.7	48.2	.125	.13	.43		
						(19x30)	TC Braid	Blue&White							.500	.25	.82		
						6.9Ω/M'	1.8Ω/M'								1.000	.40	1.31		
						22.6Ω/km	5.9Ω/km												

C(UL) AWM I/II A/B
16 AWG stranded (19x29) tinned copper drain wire.
Meter marks on jacket to aid users in installation.
Allen-Bradley P/N 1485 CPI-A

600V Class 1 ODVA Cable IV • 16 and 18 AWG Stranded Tinned Copper Conductors • Unshielded

PVC/Nylon Insulation (Power) • F-R Polypropylene Insulation (Data) • Gray Sunlight/Oil-resistant PVC Jacket

Drop 600V 75°C	7900A	NEC:	500	152.4	51.0	23.1	(2)16 AWG TC	Unshielded	Power Pair:	.430	10.92	—	—	—	—	—	—	—	
		TC-ER	1000	304.8	105.0	47.6	(19x29)		Red&Black										
		CEC: FT1					4.9Ω/M'												
								16.1Ω/km											
						(2)18 AWG TC		Data Pair:			120	64%	14.7	48.2	.125	.13	.43		
						(19x30)		Blue&White							.500	.25	.82		
						6.9Ω/M'									1.000	.40	1.31		
						22.6Ω/km													

C(UL) AWM I/II A/B
Meter marks on jacket to aid users in installation.
Allen-Bradley P/N 1485 CPI-C

DCR = DC Resistance • FEP = Fluorinated Ethylene-propylene • F-R = Flame-retardant • TC = Tinned Copper • TC-ER = Tray Cable Exposed Run per 2005 NEC Article 336

ODVA DeviceNet is an Open DeviceNet Vendor Association, Inc. trademark.



For more information, contact Belden Technical Support: 1-800-BELDEN-1 • www.belden.com

Industrial Data Solutions® — Industrial Data

DeviceBus® for ODVA DeviceNet™

Description	Part No.	UL NEC/ C(UL) CEC Type	Standard Lengths		Standard Unit Weight		Conductor (stranding) Diameter Nom. DCR	Shielding Materials Nom. DCR	Color Code	Nominal OD		Nom. Imp. (Ω)	Nom. Vel. of Prop.	Nominal Capacitance		Nominal Attenuation		
			Ft.	m	Lbs.	kg				Inch	mm			pF/Ft.	pF/m	MHz	dB/ 100 Ft.	dB/ 100m

300V Class 2 Thick • 15 and 18 AWG Stranded TC Cond. • Individually Foil Shielded (100% Coverage) + Overall TC Braid (65% Coverage)

PVC Insulation (Power) • FPE Insulation (Data) • Sunlight- and Oil-resistant PVC Jacket (Available in Gray or Red)

	3082A	NEC:	500 [†]	152.4	71.0	32.2	(2)15 AWG TC	100%	Power Pair:	.480	12.19	—	—	—	—	—	—	—
		CMG,	1000	304.8	138.0	62.6	(19x28)	Individual	Red&Black									
		PLTC-ER	2000 [†]	609.6	280.0	127.0	3.6Ω/M'	Foil										
		CEC:					11.8Ω/km	+ Overall										
		CMG FT4				(2)18 AWG TC	65%	Data Pair:			120	75%	12.0	39.4	.125	.13	.43	
						(19x30)	TC Braid	Blue&White							.500	.25	.82	
						6.9Ω/M'	1.8Ω/M'								1.000	.36	1.18	
						22.6Ω/km	5.9Ω/km											

[†]500 ft. and 2000 ft. put-ups not available in Red.
UL AWM 20201 (600V) • C(UL) AWM I/II A
18 AWG stranded (19x30) tinned copper drain wire.
Meter marks on jacket to aid users in installation. • Allen-Bradley P/N 1485 CPI-A

	3082F	NEC:	500 [†]	152.4	72.5	32.9	(2)15 AWG TC	100%	Power Pair:	.480	12.19	—	—	—	—	—	—	—
		CMG,	1000	304.8	140.0	63.5	(65x33)	Individual	Red&Black									
		PLTC-ER	2000 [†]	609.6	284.0	128.8	3.6Ω/M'	Foil										
		CEC:					11.8Ω/km	+ Overall										
		CMG FT4				(2)18 AWG TC	65%	Data Pair:			120	75%	12.0	39.4	.125	.13	.43	
						(65x36)	TC Braid	Blue&White							.500	.25	.82	
						6.9Ω/M'	1.8Ω/M'								1.000	.36	1.18	
						22.6Ω/km	5.9Ω/km											

[†]500 ft. and 2000 ft. put-ups not available in Red.
UL AWM 20201 (600V) • C(UL) AWM I/II A
18 AWG stranded (65x36) tinned copper drain wire.
Meter marks on jacket to aid users in installation. • Allen-Bradley P/N 1485 CPI-A

PVC Insulation (Power) • FPE Insulation (Data) • Yellow CPE Jacket

	3083A	NEC:	1000	304.8	137.0	62.1	(2)15 AWG TC	100%	Power Pair:	.475	12.07	—	—	—	—	—	—	—
		CMG, PLTC	2000	609.6	278.0	126.1	(19x28)	Individual	Red&Black									
		CEC:					3.6Ω/M'	Foil										
		CMG FT4					11.8Ω/km	+ Overall										
						(2)18 AWG TC	65%	Data Pair:			120	75%	12.0	39.4	.125	.13	.43	
						(19x30)	TC Braid	Blue&White							.500	.25	.82	
						6.9Ω/M'	1.8Ω/M'								1.000	.36	1.18	
						22.6Ω/km	5.9Ω/km											

18 AWG stranded (19x30) tinned copper drain wire.
Meter marks on jacket to aid users in installation. • Allen-Bradley P/N 1485 CPI-A

300V Class 2 Thin • 22 and 24 AWG Stranded TC Conductors • Individ. Foil Shielded (100% Coverage) + Overall TC Braid (65% Coverage)

PVC Insulation (Power) • FPE Insulation (Data) • Gray Sunlight- and Oil-resistant PVC Jacket

	3084A	NEC:	500	152.4	22.0	10.0	(2)22 AWG TC	100%	Power Pair:	.280	7.11	—	—	—	—	—	—	—
		CL2 CMG	1000 [†]	304.8	47.0	21.3	(19x34)	Individual	Red&Black									
		CEC:	2000	609.6	96.0	43.6	17.5Ω/M'	Foil										
		CMG FT4					57.4Ω/km	+ Overall										
						(2)24 AWG TC	65%	Data Pair:			120	75%	12.0	39.4	.125*	.29*	.95*	
						(19x36)	TC Braid	Blue&White							.500*	.50*	1.64*	
						91.9Ω/km	10.5Ω/km								1.000*	.70*	2.30*	

[†]1000 ft. put-up also available in Red.
22 AWG stranded (19x34) tinned copper drain wire. • C(UL) AWM I/II A
Meter marks on jacket to aid users in installation. • Allen-Bradley P/N 1485 CPI-C

	3084F	NEC:	500	152.4	22.0	10.0	(2)22 AWG TC	100%	Power Pair:	.275	6.99	—	—	—	—	—	—	—
		CL2 CMG	1000	304.8	47.0	21.3	(154x44)	Individual	Red&Black									
		CEC:	2000	609.6	96.0	43.6	17.5Ω/M'	Foil										
		CMG FT4					57.4Ω/km	+ Overall										
						(2)24 AWG TC	65%	Data Pair:			120	75%	12.0	39.4	.125*	.29*	.95*	
						(105x44)	TC Braid	Blue&White							.500*	.50*	1.64*	
						28.0Ω/M'	3.2Ω/M'								1.000*	.70*	2.30*	
						91.9Ω/km	10.5Ω/km											

C(UL) AWM I/II A
22 AWG stranded (26x36) tinned copper drain wire.
Meter marks on jacket to aid users in installation. • Allen-Bradley P/N 1485 CPI-C

PVC Insulation (Power) • FPE Insulation (Data) • Yellow CPE Jacket

	3085A	NEC:	500	152.4	25.0	11.4	(2)22 AWG TC	100%	Power Pair:	.280	7.11	—	—	—	—	—	—	—
		CL2 CMG	1000	304.8	47.0	21.4	(19x34)	Individual	Red&Black									
		CEC:	2000	609.6	96.0	43.6	17.5Ω/M'	Foil										
		CMG FT4					57.4Ω/km	+ Overall										
						(2)24 AWG TC	65%	Data Pair:			120	75%	12.0	39.4	.125*	.29*	.95*	
						(19x36)	TC Braid	Blue&White							.500*	.50*	1.64*	
						28.0Ω/M'	3.2Ω/M'								1.000*	.70*	2.30*	
						91.9Ω/km	10.5Ω/km											

22 AWG stranded (19x34) tinned copper drain wire.
Meter marks on jacket to aid users in installation. • Allen-Bradley P/N 1485 CPI-C

DCR = DC Resistance • FPE = Foam Polyethylene • PLTC-ER = Power Limited Tray Cable - Exposed Run per 2005 NEC Article 725 • TC = Tinned Copper

*These values are Maximum Attenuation.

ODVA DeviceNet is an Open DeviceNet Vendor Association, Inc. trademark.



For more information, contact Belden Technical Support: 1-800-BELDEN-1 • www.belden.com

Industrial Data Solutions® — Industrial Data

DeviceBus® for ODVA DeviceNet™

Description	Part No.	UL NEC/ C(UL) CEC Type	Standard Lengths		Standard Unit Weight		Conductor (stranding) Diameter Nom. DCR	Shielding Materials Nom. DCR	Color Code	Nominal OD		Nom. Imp. (Ω)	Nom. Vel. of Prop.	Nominal Capacitance		Maximum Attenuation		
			Ft.	m	Lbs.	kg				Inch	mm			pF/Ft.	pF/m	MHz	dB/100 Ft.	dB/100m

300V Class 2 ODVA Cable III • 20 and 18 AWG Stranded TC Cond. • Indiv. Foil Shielded (100% Coverage) + Overall TC Braid (65% Coverage)

PVC Insulation (Power) • FPE Insulation (Data) • Gray Sunlight/Oil-resistant PVC Jacket

Mid 75°C	7895A	NEC: CMG PLTC CEC: CMG FT4	500 1000	152.4 304.8	41.0 84.0	18.6 38.1	(2)18 AWG TC (19x30) 6.9Ω/M' 22.6Ω/km (2)20 AWG TC (19x32) 10.9Ω/M' 35.8Ω/km	100% Individual Foil + Overall 65% TC Braid 10.5Ω/km	Power Pair: Red&Black	.378	9.60	—	—	—	—	—	—	—
									Data Pair: Blue&White			120	75%	12.0	39.4	.125 .500 1.000	.29 .50 .70	.95 1.64 2.30

UL AWM 20201 (600V)
20 AWG stranded (19x32) tinned copper drain wire.
Meter marks on jacket to aid users in installation.

Flat • 16 AWG Stranded (19x29) Tinned Copper Conductors • Unshielded

PVC Insulation (Power) • FPE Insulation (Data) • Gray Sunlight-resistant PVC Jacket

Class 2 300V 75°C	3082K	NEC: CMG CL2 PLTC CEC: CMG FT4	246 656 1378	75.0 200.0 420.0	30.8 78.7 165.4	14.0 35.7 75.1	(4)16 AWG TC (19x29) 4.9Ω/M' 16.1Ω/km	Unshielded	Power Pair: Red&Black	.760 x .210	10.92 x 5.33	—	—	—	—	—	—	—
									Data Pair: Blue&White			120	75%	14.7	48.2	.125 .500 1.000	.13 .25 .40	.43 .82 1.31

Allen-Bradley P/N 1485 CPI-G

PVC Insulation • Black Sunlight-resistant PVC Jacket

Class 1 Power 600V 75°C	3082KP	NEC: CMG, ITC, PLTC, TC CEC: CMG FT4	246 656 1378	75.0 200.0 420.0	32.0 81.3 170.9	14.5 36.9 77.6	(4)16 AWG TC (19x29) 4.9Ω/M' 16.1Ω/km	Unshielded	Red&Black, Blue&White	.760 x .210	10.92 x 5.33	—	—	—	—	—	—	—
																.125 .500 1.000	.13 .25 .40	.43 .82 1.31

Allen-Bradley P/N 1485 CPI-G

DCR = DC Resistance • FPE = Foam Polyethylene • F-R = Flame-retardant • TC = Tinned Copper if conductor, or Tray Cable if NEC rating.

ODVA DeviceNet is an Open DeviceNet Vendor Association, Inc. trademark.

Industrial Data Solutions® — Industrial Data

DeviceBus® for Honeywell Smart Distributed System

Description	Part No.	UL NEC/ C(UL) CEC Type	Standard Lengths		Standard Unit Weight		Conductor (stranding) Diameter Nom. DCR	Shielding Materials Nom. DCR	Color Code	Nominal OD		Nom. Imp. (Ω)	Nom. Vel. of Prop.	Nominal Capacitance		Nominal Attenuation		
			Ft.	m	Lbs.	kg				Inch	mm			pF/Ft.	pF/m	MHz	dB/ 100 Ft.	dB/ 100m

22 AWG Stranded Tinned Copper Conductors • Each Pair Individually Beldfoil® Shielded (100% Coverage) • Drain Wire

PVC Insulation (Power) • FPE Insulation (Data) • Gray PVC Jacket																
UL AWM	3087A	NEC:	500	152.4	19.0	8.6	(4)22 AWG	100%	Power Pair:	.290	7.37	—	—	—	—	—
Style 2464		CL2	1000	304.8	41.0	18.6	(19x34)	Beldfoil	Blue&Brown							
30V 80°C		CEC:	2000	609.6	84.0	38.1	.030"	Each Pair								
CSA AWM I/II A		FT1					Tinned Copper		Data Pair:							
							17.5Ω/M'		Black&White	120	76%	12.0	39.4	.125	.23	.76
							57.4Ω/km							.500	.42	1.38
														1.000	.60	1.97

Micro Cable (Drop)
22 AWG stranded (19x34) tinned copper drain wire.

16 and 20 AWG Stranded Tinned Copper Conductors • Each Pair Individually Beldfoil Shielded (100% Coverage) • Drain Wire

PVC Insulation (Power) • FPE Insulation (Data) • Gray PVC Jacket																
UL AWM	3086A	NEC:	500	152.4	43.5	19.7	(2)16 AWG TC	100%	Power Pair:	.398	10.11	—	—	—	—	—
Style 2464		CL2	1000	304.8	88.0	39.9	(19x29)	Beldfoil	Blue&Brown							
30V 80°C		CEC:					.067"	Each Pair								
CSA AWM I/II A		FT1					3.6Ω/M'		Data Pair:							
							11.8Ω/km		Black&White	120	76%	12.0	39.4	.125	.18	.59
							(2)20 AWG TC							.500	.35	1.15
							(19x32)							1.000	.47	1.54
							.041"									
							10.0Ω/M'									
							32.8Ω/km									

Mini Cable (Trunk)
20 AWG stranded (19x32) tinned copper drain wire.

DCR = DC Resistance • FPE = Foamed Polyethylene • TC = Tinned Copper

Industrial Data Solutions® — Industrial Data

DeviceBus® for Square D/Seriplex®

Description	Part No.	UL NEC/ C(UL) CEC Type	Standard Lengths		Standard Unit Weight		Conductor (stranding) Diameter Nom. DCR	Shielding Materials Nom. DCR	Color Code	Nominal OD		Nom. Imp. (Ω)	Nom. Vel. of Prop.	Nominal Capacitance*	
			Ft.	m	Lbs.	kg				Inch	mm			pF/Ft.	pF/m

18 and 22 AWG Stranded Tinned Copper Conductors • Overall 100% Beldfoil® Shield (100% Coverage) • 22 AWG (7x30) TC Drain Wire

Foam HDPE Insulation (Power) • Foam HDPE Insulation (Data) • Orange PVC Jacket															
	3124A UL AWM Style 20201 (600V 75°C)	NEC: CL2 CM CEC: CM	1000	304.8	47.0	21.3	(2)18 AWG (16x30)	100% Overall	Power Cdrs: Red&Black Data Cdrs: White&Green	.308	7.82	—	—	20.0	65.6
							.040" TC 6.8Ω/M' 21.3Ω/km	Beldfoil Shield 10.7Ω/M' 35.1Ω/km							78%
Seriplex CBL 1822-P18															

16 and 22 AWG Stranded Tinned Copper Conductors • Overall 100% Beldfoil Shield (100% Coverage) • 22 AWG (7x30) TC Drain Wire

Foam HDPE Insulation (Power) • Foam HDPE Insulation (Data) • Orange PVC Jacket															
	3125A 300V 75°C	NEC: CL2 CM CEC: CM	500	152.4	31.5	14.3	(2)16 AWG (26x30)	100% Overall	Power Cdrs: Red&Black Data Cdrs: White&Green	.368	9.35	—	—	28.0	91.9
							.060" TC 4.5Ω/M' 14.8Ω/km	Beldfoil Shield 10.7Ω/M' 35.1Ω/km							78%
Seriplex CBL 1622-P1															

16, 22 and 12 AWG Stranded Tinned Copper Conductors • Overall Beldfoil Shield (100% Coverage) • 22 AWG (7x30) TC Drain Wire

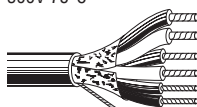
Foam HDPE Insulation (Control) • Foam HDPE Insulation (Data) • PVC Insulation (Power) • Orange PVC Jacket															
	3126A 300V 75°C	NEC: CL2 CM CEC: CM	1000	304.8	112.0	50.8	(2)16 AWG (26x30)	100% Overall	Control Cdrs: Red&Black Power Cdrs: Black&White, Red&White	.486	12.34	—	—	28.0	91.9
							.060" TC 4.5Ω/M' 14.7Ω/km	Beldfoil Shield 10.7Ω/M' 35.1Ω/km							
Seriplex CBL 162212-P16															

DCR = DC Resistance • HDPE = High-density Polyethylene • TC = Tinned Copper
 *Capacitance between one conductor and other conductors connected to shield.

Square D/Seriplex is a Square D/Schneider AEG trademark.



Industrial Data Solutions® — Industrial Data

DeviceBus® for Phoenix Contact InterBus®-S



Description	Part No.	UL NEC/ C(UL) CEC Type	Standard Lengths		Standard Unit Weight		Conductor (stranding) Diameter Nom. DCR	Shielding Materials Nom. DCR	Color Code	Nominal OD		Nom. Imp. (Ω)	Nom. Vel. of Prop.	Nominal Capacitance*	
			Ft.	m	Lbs.	kg				Inch	mm			pF/Ft.	pF/m

18 and 24 AWG Stranded Tinned Copper Conductors • Overall Beldfoil® Shield (100% Coverage) + Tinned Copper Braid (90% Coverage)

PVC Insulation (Power) • PE Insulation (Data) • Green Polyurethane Jacket															
UL AWM Style 20233 (300V 80°C)	3119A	—	500	152.4	35.5	16.1	(3)18 AWG (7x26) .060" TC 6.6Ω/M' 21.7Ω/km (3pr)24 AWG (7x32) .024" TC 23.4Ω/M' 76.8Ω/km	100% Overall Beldfoil + 90% TC Braid 2.7Ω/M' 8.9Ω/km	Power: Red, Blue, Green w/ Yellow Stripe Data: Pink&Gray, White&Brown, Yellow&Green	.333	8.46	—	—	—	—
			1000	304.8	71.0	32.2				100	66%	15.4	50.5		



24 AWG Stranded Tinned Copper Conductors • Overall 100% Beldfoil Shield (100% Coverage) + Tinned Copper Braid (90% Coverage)

Polyethylene Insulation • Green Polyurethane Jacket															
UL AWM Style 20233 (300V 80°C)	3120A	—	500	152.4	26.0	11.8	(3pr)24 AWG (7x32) TC 26.0Ω/M' 85.3Ω/km	100% Overall Beldfoil + 90% TC Braid 2.7Ω/M' 8.9Ω/km	Pink&Gray, White&Brown, Yellow&Green	.277	7.04	100	66%	15.4	50.5
			1000	304.8	49.0	22.2									



DCR = DC Resistance • PE = Polyethylene • PVC = Polyvinyl Chloride • TC = Tinned Copper

*Capacitance between one conductor and other conductors connected to shield.





InterBus-S is a Phoenix Contact trademark.



For more information, contact Belden Technical Support: 1-800-BELDEN-1 • www.belden.com

Industrial Data Solutions® — Industrial Data

EIA Industrial RS-485 PLTC/CM

Description	Part No.	UL NEC/ C(UL) CEC Type	No. of Pairs	Color Code	Standard Lengths		Standard Unit Weight		Nom. DCR		Nominal OD		Nom. Imp. (Ω)	Nom. Vel. of Prop.	Nom. Capacitance					
					Ft.	m	Lbs.	kg	Cond.	Shield	Inch	mm			* pF/ Ft.	* pF/ m	** pF/ Ft.	** pF/ m		
22 AWG Stranded (7x30) TC Conductors • Twisted Pairs • Overall Beldfoil® Shield (100% Coverage) + TC Braid (90% Coverage) • Drain Wire[^]																				
Datalene® Insulation • Black UV Resistant PVC Jacket (CPE jacket optional)																				
Oil Res II 300V 	3105A[†]	NEC: CM PLTC	1	See Chart (below)	500	152.4	23.0	10.4	14.7Ω/M'	2.8Ω/M'	.284	7.21	120	78%	11.0	36.1	20.9	68.6		
		CEC: CM FT1			1000	304.8	50.0	22.7	48.2Ω/km	9.2Ω/km	For CPE jacketed version order Part No. YR44345									
	3106A	NEC: CM PLTC	1.5 [*]	White/Orange, Orange/White, Blue/White	500	152.4	27.0	12.3	14.7Ω/M'	2.8Ω/M'	.300	7.62	120	78%	11.0	36.1	20.9	68.6		
		CEC: CM FT1			1000	304.8	51.0	23.2	48.2Ω/km	9.2Ω/km	For CPE jacketed version order Part No. YR46721									
		CEC: CM FT1			5000 [†]	1523.9	260.0	118.1												
	3107A[†]	NEC: CM PLTC	2	See Chart (below)	1000	304.8	69.0	31.3	14.7Ω/M'	1.8Ω/M'	.356	9.04	120	78%	11.0	36.1	20.9	68.6		
		CEC: CM FT1			4000	1219.2	300.0	136.2	48.2Ω/km	5.9Ω/km	For CPE jacketed version order Part No. YR46792									
		CEC: CM FT1			5000 [†]	1523.9	385.0	174.8												
	3108A	NEC: CM PLTC	3	See Chart (below)	1000	304.8	93.0	42.2	14.7Ω/M'	1.5Ω/M'	.420	10.67	120	78%	11.0	36.1	20.9	68.6		
		CEC: CM FT1			2000	609.6	184.0	83.5	48.2Ω/km	4.9Ω/km	For CPE jacketed version order Part No. YR45287									
	3109A	NEC: CM PLTC	4	See Chart (below)	1000	304.8	107.0	48.6	14.7Ω/M'	1.4Ω/M'	.420	10.67	120	78%	11.0	36.1	20.9	68.6		
		CEC: CM FT1			2000	609.6	218.0	99.0	48.2Ω/km	4.6Ω/km	For CPE jacketed version order Part No. YR44768									

^{*}3015A and 3107A are DMX512 Type.
^{*}22 AWG stranded tinned copper drain wire.

AL Interlocked Armor • Datalene® Insulation • PVC Inner Jacket • Black UV Resistant PVC Outer Jacket																		
300V 	123107A <small>(NEW)</small>	NEC: CM PLTC	2	See Chart (below)	5000 ^{††}	1523.9	1140.0	514.1	14.7Ω/M'	1.8Ω/M'	.650	16.51	120	78%	11.0	36.1	20.9	68.6
		CEC: CMG FT4							48.2Ω/km	5.9Ω/km								

^{*}22 AWG stranded tinned copper drain wire.

DCR = DC Resistance • TC = Tinned Copper

* Capacitance between conductors.
^{**}Capacitance between one conductor and other conductors connected to shield.

[†] Final put-up length may vary -0 to +10% from length shown.
^{††} Final put-up length may vary ±10% for spools or reels and ±5% for UnReel® cartons from length shown.

^{*}All conductors are under the braid shield; one pair is under the Beldfoil shield.

Color Code Chart

Pair No.	Color Combination
1	White/Blue Stripe Blue/White Stripe
2	White/Orange Stripe Orange/White Stripe
3	White/Green Stripe Green/White Stripe
4	White/Brown Stripe Brown/White Stripe



Industrial Data Solutions® — Interconnect Cable

Shielded Twisted Pair Cables

Description	Part No.	UL NEC/ C(UL) CEC Type	No. of Pairs	Color Code	Standard Lengths		Standard Unit Weight		Nom. DCR		Nominal OD		Nom. Imp. (Ω)	Nom. Vel. of Prop.	Nom. Capacitance			
					Ft.	m	Lbs.	kg	Cond.	Shield	Inch	mm			* pF/ Ft.	* pF/ m	** pF/ Ft.	** pF/ m

24 AWG Stranded (7x32) TC Conductors • Twisted Pairs • Individually Beldfoil® Shielded (100% Coverage) • 24 AWG Stranded TC Drain Wire

Datalene® Insulation • Chrome PVC Jacket

UL AWM Style 2493 (300V 60°C)	9729	NEC: CM CEC: CM	2	Red&Black, White&Black	100	30.5	4.3	2.0	24.0Ω/M'	15.0Ω/M'	.266	6.76	100	76%	12.5	41.0	23.2	76.1
					500	152.4	20.5	9.3	78.7Ω/km	49.3Ω/km								
					1000	304.8	39.0	17.7										
					10000	3048.0	390.0	177.1										

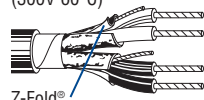

Z-Fold®

24 AWG stranded (7x32) tinned copper drain wire.

For Plenum version of 9729, see 89729 or 82729.

22 AWG Stranded (7x30) TC Conductors • Twisted Pairs • Individually Beldfoil Shielded (100% Coverage) • 22 AWG Stranded TC Drain Wire

Polypropylene Insulation • Chrome PVC Jacket

UL AWM Style 2919 (30V 80°C)	8777	NEC: CM CEC: CM	3	Red&Black, White&Black, Green&Black	100	30.5	4.6	2.1	15.0Ω/M'	10.6Ω/M'	.273	6.93	50	66%	30	98	55	180
					250	76.2	11.0	5.0	49.2Ω/km	34.8Ω/km								
					U-500	U-152.4	21.0	9.5										
					500	152.4	21.0	9.5										
					U-1000	U-304.8	41.0	18.6										
					1000	304.8	42.0	19.1										
					1640	499.9	67.2	30.5										
					3280	999.7	137.8	62.5										
					5000	1524.0	210.0	95.3										
					10000	3048.0	450.0	204.3										

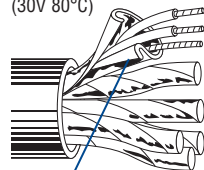

Z-Fold®

22 AWG stranded (19x34) tinned copper drain wire.

For Plenum versions of 8777, see 88777, 87777 or 82777.

22 AWG Stranded (7x30) TC Conductors • Twisted Pairs • Individually Beldfoil Shielded (100% Coverage) • 24 AWG Stranded TC Drain Wire

Polypropylene Insulation • Chrome PVC Jacket (Pairs Cabled on Common Axis to Reduce Diameter)

300V RMS 60°C	8723	NEC: CM CEC: CM	2	Red&Black, Green&White	100	30.5	2.3	1.0	16.0Ω/M'	14.7Ω/M'	.168	4.27	45	66%	35	115	62	203
					U-500	U-152.4	10.5	4.8	52.5Ω/km	48.3Ω/km								
					500	152.4	10.0	4.5										
					U-1000	U-304.8	20.0	9.1										
					1000	304.8	20.0	9.1										
					1640	499.9	32.8	14.9										
					U-2000	U-609.6	40.0	18.2										
					2000	609.6	40.0	18.2										
					3280	999.7	65.6	29.8										
					5000	1524.0	95.0	43.1										
					10000	3048.0	200.0	90.8										

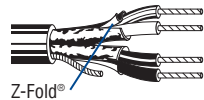

Z-Fold®

24 AWG stranded (7x32) tinned copper drain wire.

For Plenum versions of 8723, see 88723, 87723 or 82723.

Plenum • FEP Insulation • Red FEP Jacket (Pairs Cabled on Common Axis to Reduce Diameter)

300V RMS, Non-conduit	88723	NEC: CMP CEC: CMP FT6	2	Red&Black, Green&White	100	30.5	3.4	1.5	16.0Ω/M'	14.7Ω/M'	.148	3.76	40	69%	35	115	67	220
					500	152.4	11.0	5.0	52.5Ω/km	48.3Ω/km								
					1000	304.8	21.0	9.5										



Z-Fold®

24 AWG stranded (7x32) tinned copper drain wire.

18 AWG Stranded (16x30) TC Conductors • Twisted Pair • Overall Beldfoil Shield (100% Coverage) • 20 AWG Stranded TC Drain Wire

Polyethylene Insulation • Chrome PVC Jacket

UL AWM Style 2092 (300V 60°C)	8760	NEC: CM CEC: CM	1	Black &Clear	250	76.2	6.8	3.1	—	—	.222	5.64	—	—	24	79	44	144
					U-500	U-152.4	13.0	5.9										
					500	152.4	13.0	5.9										
					U-1000	U-304.8	26.0	11.8										
					1000	304.8	26.0	11.8										
					2000	609.6	50.0	22.7										
					5000	1524.0	135.0	61.3										
					10000	3048.0	260.0	118.0										

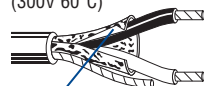

Shorting Fold

20 AWG stranded (7x28) tinned copper drain wire.

For Plenum versions of 8760, see 88760, 87760 or 82760.





DCR = DC Resistance • FEP = Fluorinated Ethylene Propylene • PVC = Polyvinyl Chloride • TC = Tinned Copper

* Capacitance between conductors.

** Capacitance between one conductor and other conductors connected to shield.

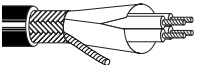
VFD (Variable Frequency Drive) Cable

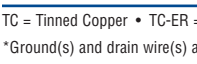



1000V UL Flexible Motor Supply Cable

Description	Part No.	AWG	Cond. Stranding	Standard Lengths		Standard Unit Wt.		Nominal OD		Maximum Pull Tension		Minimum Bend Radius		
				Ft.	m	Lbs.	kg	Inch	mm	Lbs.	N	Inch	mm	
4-cond. (3) Stranded TC Circuit Conductors + (1) Ground* • Overall Beldfoil® (100% Coverage) + TC Braid Shield (85% Coverage) • TC Drain Wire*														
XLPE Insulation (Circuit Condrs) • PVC Insulation (Ground) • Black Sunlight- and Oil-resistant PVC Jacket														
1000V UL Flexible Motor Supply Cable 600V UL 1277 Type TC-ER per 2005 NEC Article 336 1000V CSA AWM I/II A/B FT4 90°C Wet/Dry 	29500	16	26x30	250†	76.2	46.2	21.0	.53	13.46	128	568	3.9	99.06	
				500†	152.4	93.0	42.2							
				1000†	304.8	182.0	82.6							
				6000†	1828.8	1080.0	490.3							
	All Allen-Bradley Series 160 and 1305 drives.	29501	14	41x30	250†	76.2	59.7	27.1	.55	13.97	212	942	4.5	114.30
					500†	152.4	120.0	54.5						
					1000†	304.8	233.0	105.8						
					5000†	1524.0	1215.0	551.6						
	Allen-Bradley 1336F(S)-BRF05 through BRF100	29502	12	65x30	250†	76.2	69.8	31.7	.60	15.24	336	1495	4.9	124.46
					500†	152.4	151.5	68.8						
1000†					304.8	298.0	135.3							
5000†					1524.0	1570.0	712.8							
Allen-Bradley 1336F(S)-BRF150, BRF200	29503	10	105x30	250†	76.2	91.3	41.4	.66	16.76	525	2335	5.4	137.16	
				500†	152.4	194.5	88.3							
				1000†	304.8	375.0	170.3							
				5000†	1524.0	2025.0	919.4							
Allen-Bradley 1336F(S)-B015	29504	8	7x19x29	250†	76.2	158.5	72.0	.89	22.61	1328	5906	7.3	185.42	
				500†	152.4	332.0	150.7							
				1000†	304.8	660.0	299.6							
				5000†	1524.0	3135.0	1423.3							
Allen-Bradley 1336F(S)-B020	29505	6	7x19x27	250†	76.2	221.3	100.5	.99	25.15	2048	9109	8.0	203.20	
				1000†	304.8	906.0	411.3							
				3500†	1066.8	3206.0	1455.5							
				5000†	1524.0	4779.0	2169.7							
Allen-Bradley 1336F(S)-B025, B030	29506	4	7x19x25	250†	76.2	319.5	145.1	1.15	29.21	3152	14021	9.2	233.68	
				1000†	304.8	1231.0	558.9							
				3000†	914.4	3843.0	1744.7							
				5000†	1524.0	4779.0	2169.7							
Allen-Bradley 1336F(S)-BX040, B040	29507	2	7x19x23	250†	76.2	437.8	198.7	1.29	32.77	4872	21672	10.5	266.70	
				500†	152.4	875.5	397.5							
				1000†	304.8	1711.0	776.8							
				2000†	609.6	3682.0	1671.6							
Allen-Bradley 1336F(S)-B050, BX060, B060	29508	1	7x19x22	250 ††	76.2	398.8	181.0	1.20	30.48	2650	11788	12.0	304.8	
				1000 ††	304.8	1642.0	746.0							
				3000 †	1524.0	4779.0	2169.7							
				5000 †	1524.0	4779.0	2169.7							
1000V UL Flexible Motor Supply Cable 600V UL 1277 Type TC-ER per 2005 NEC Article 336 600V CSA AWM I/II A/B FT4 90°C Wet/Dry 	29529	1/0	7x19x21	250 ††	76.2	525.8	238.7	1.29	32.77	3537	15733	12.9	327.7	
				1000 ††	304.8	2050.0	930.7							
				2000 †	609.6	3954.0	1795.1							
				5000 †	1524.0	4779.0	2169.7							
1000V UL Flexible Motor Supply Cable 600V UL 1277 Type TC-ER per 2005 NEC Article 336 600V CSA AWM I/II A/B FT4 90°C Wet/Dry 	29530	2/0	7x19x20	250 ††	76.2	602.0	273.3	1.40	35.56	4200	18682	14.0	355.6	
				1000 ††	304.8	2362.0	1072.4							
				2000 †	609.6	4744.0	2153.8							
				5000 †	1524.0	4779.0	2169.7							
1000V UL Flexible Motor Supply Cable 600V UL 1277 Type TC-ER per 2005 NEC Article 336 600V CSA AWM I/II A/B FT4 90°C Wet/Dry 	29531	3/0	7x19x19	250 ††	76.2	699.5	317.6	1.52	38.61	5025	22352	15.2	386.1	
				1000 ††	304.8	2708.0	1229.4							
				3000 †	1524.0	5436.0	2467.9							
				5000 †	1524.0	4779.0	2169.7							
1000V UL Flexible Motor Supply Cable 600V UL 1277 Type TC-ER per 2005 NEC Article 336 600V CSA AWM I/II A/B FT4 90°C Wet/Dry 	29532	4/0	7x19x18	250 ††	76.2	881.0	400.0	1.68	42.67	6670	29670	16.8	426.7	
				500 ††	152.4	1873.0	850.3							
				1500 †	457.2	5619.0	2551.0							
				5000 †	1524.0	4779.0	2169.7							

Color Code: ICEA Method 4 (Black and Numbered); Green/Yellow Ground

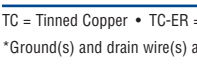
UL Direct Burial. XHHW-2, RHW-2 rated circuit conductors.

Three (3) Stranded TC Circuit Conductors + (3) Symmetrical Bare Copper Grounds • (2) Spiral Copper Tape Shields (100% Coverage)

XLPE Insulation (Circuit Condrs) • Black Sunlight- and Oil-resistant PVC Jacket													
1000V UL Flexible Motor Supply Cable 600V UL 1277 Type TC-ER per 2005 NEC Article 336 600V CSA AWM I/II A/B FT4 90°C Wet/Dry 	29528	1	7x19x22	250 ††	76.2	398.8	181.0	1.20	30.48	2650	11788	12.0	304.8
				1000 ††	304.8	1642.0	746.0						
				3000 †	1524.0	4779.0	2169.7						
				5000 †	1524.0	4779.0	2169.7						
1000V UL Flexible Motor Supply Cable 600V UL 1277 Type TC-ER per 2005 NEC Article 336 600V CSA AWM I/II A/B FT4 90°C Wet/Dry 	29529	1/0	7x19x21	250 ††	76.2	525.8	238.7	1.29	32.77	3537	15733	12.9	327.7
				1000 ††	304.8	2050.0	930.7						
				2000 †	609.6	3954.0	1795.1						
				5000 †	1524.0	4779.0	2169.7						
1000V UL Flexible Motor Supply Cable 600V UL 1277 Type TC-ER per 2005 NEC Article 336 600V CSA AWM I/II A/B FT4 90°C Wet/Dry 	29530	2/0	7x19x20	250 ††	76.2	602.0	273.3	1.40	35.56	4200	18682	14.0	355.6
				1000 ††	304.8	2362.0	1072.4						
				2000 †	609.6	4744.0	2153.8						
				5000 †	1524.0	4779.0	2169.7						
1000V UL Flexible Motor Supply Cable 600V UL 1277 Type TC-ER per 2005 NEC Article 336 600V CSA AWM I/II A/B FT4 90°C Wet/Dry 	29531	3/0	7x19x19	250 ††	76.2	699.5	317.6	1.52	38.61	5025	22352	15.2	386.1
				1000 ††	304.8	2708.0	1229.4						
				3000 †	1524.0	5436.0	2467.9						
				5000 †	1524.0	4779.0	2169.7						
1000V UL Flexible Motor Supply Cable 600V UL 1277 Type TC-ER per 2005 NEC Article 336 600V CSA AWM I/II A/B FT4 90°C Wet/Dry 	29532	4/0	7x19x18	250 ††	76.2	881.0	400.0	1.68	42.67	6670	29670	16.8	426.7
				500 ††	152.4	1873.0	850.3						
				1500 †	457.2	5619.0	2551.0						
				5000 †	1524.0	4779.0	2169.7						

TC = Tinned Copper • TC-ER = Tray Cable - Exposed Run per 2005 NEC Article 336 • XLPE = Cross-linked Polyethylene

*Ground(s) and drain wire(s) are same AWG as circuit conductors.

†Final put-up length may vary ±10% from length shown.

††Final put-up length may vary ±5% from length shown.

Encoder Cables

Belden also offers the following standard cables for encoder applications. Encoder cables help feed information to the microprocessor regarding both the speed and the position of the rotor.

Part No.	Pairs	AWG
8790 (Power Supply)	1	18
9729	2	24
9730, 89730	3	24
9728	4	24
9892	4	20

See Index for page numbers.



Belden Infinity® Flexible Automation Cable

Overview and Application Guide

Belden Infinity is a complete line of control, data, video, and power cables specifically designed to handle the rigorous speeds and near-constant motion encountered in automated equipment such as robots, pick and place machines, automatic handling systems, multi-axis machine tools, and conveyor systems.

When the application demands highly flexible cables offering exceptional cable life and performance, specify Belden Infinity.

Belden Infinity Means More Performance And Longer Life

Reduced Cable Memory — Belden Infinity's unique design and neutralized cabling, results in cables that are relaxed, with almost no memory.

Greater Flex Life — Belden Infinity cables offer superior flexibility and are able to handle the vigorous motions and high speeds encountered in automated equipment.

Greater System Uptime — Belden Infinity cables combine specialized manufacturing techniques with precision copper stranding and rugged insulation and jacketing compounds to maximize flex life and reliability.

No Talc Problems — Unlike the potentially harmful talc used in other cables, Belden's non-toxic, non-irritating slipper compound facilitates flexing and also complies with OSHA regulations. It's safer for employees and operators and is less likely to contaminate solder joints or mechanical compounds.

CE Conformity — All Belden Infinity cables are CE marked per the Conformité Européenne low voltage directive, allowing trade of product in Europe.

Custom Designs — Other designs available upon request.

Product Series Descriptions

- **C-TC+** — The C-TC+ series is designed for C-track and extreme flex applications up to 9 million flex cycles*. This series utilizes super fine stranding and some of the tightest lay lengths allowed by UL, providing outstanding flex life.
- **FCC** — The FCC series is a cost effective alternative for C-track and moderate flexing applications rated up to 1 million flex cycles*.
- **Flex Data Cables** — Belden Infinity Flex Data cables are designed for industrial applications where precise data transmission is combined with high-flexing. These cables are ideal for effective operation of computer controlled equipment or other automated production processes, even in harsh environments.
- **Flex Vision** — Belden Infinity Vision cables are continuous flex video cables designed for machine vision applications. They are ideal for motion-controlled video and with inspection and measurement equipment.

Application Guide

Belden Infinity Series	C-Track Systems	Multi-Axis Machining	Robotics	Automated Assembly Systems	Material Handling Systems	Pick & Place Systems	Automated Storage Retrieval	Gantry Systems	Machine Vision	Motion-Controlled Video	Inspection & Measure Equip.	Festooning	Servo	Power
------------------------	-----------------	----------------------	----------	----------------------------	---------------------------	----------------------	-----------------------------	----------------	----------------	-------------------------	-----------------------------	------------	-------	-------

FCC Oil & abrasion resistant 600V UL & CSA rated Life Expectancy: Over 1 million flex cycles*	●	●	●	●	●	●	●	●	●	●	●	●	●	●
C-TC+ Oil & abrasion resistant 600V UL & CSA rated Life Expectancy: Over 9 million flex cycles*	★	★	●	★	★	★	★	★	●	●	★	★	★	★
DATA Oil & abrasion resistant 300V UL & CSA rated Life Expectancy: Over 1 million flex cycles*	●	●	●	●	●	●	●	●	●	●	●	●	●	●
VISION 30V UL & CSA rated Life Expectancy: Over 1 million flex cycles*	●	●	●	●	●	●	●	●	★	+	+	●	●	●

● Good + Better ★ Best

*Based on proper installation techniques in a C-track cable guide.

Belden Infinity® Flexible Automation Cable

600V C-TC+ Control Cables for Extreme Flexing

(9 Million Flex Cycles*)

Description	Part No.	No. of Cond.	Standard Lengths		Standard Unit Weight		Insulation Thickness		Jacket Thickness		Nominal OD		Maximum Pull Tension	
			Ft.	m	Lbs.	kg	Inch	mm	Inch	mm	Inch	mm	Lbs.	N

20 AWG Stranded (74x38) Bare Copper Conductors • Unshielded • Color Code: Red w/numbers + Green/Yellow ground

PVC Insulation • Orange Oil- and Abrasion-resistant PVC Jacket

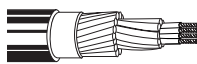
	UL AWM Style 2587 (600V 90°C) CSA AWM I/II A/B	7101A	3	250 †	76.2	11.0	5.0	.020	.51	.045	1.14	.275	6.99	45	200
				500 †	152.4	24.5	11.1								
				1000 †	304.8	47.0	21.3								
		7102A	4	250 †	76.2	13.3	6.0	.020	.51	.045	1.14	.295	7.49	59	262
				500 †	152.4	27.5	12.5								
				1000 †	304.8	53.0	24.1								
		7105A	9	250 †	76.2	29.8	13.5	.020	.51	.055	1.40	.435	11.05	130	578
				500 †	152.4	52.0	23.6								
1000 †				304.8	104.0	47.2									
	7106A	12	250 †	76.2	32.3	14.6	.020	.51	.055	1.40	.455	11.56	178	792	
			500 †	152.4	66.5	30.2									
			1000 †	304.8	134.0	60.8									
	7107A	18	250 †	76.2	50.0	22.7	.020	.51	.065	1.65	.545	13.84	260	1156	
			500 †	152.4	101.0	45.9									
			1000 †	304.8	202.0	91.8									
Temp Rating: -40° to 90°C (-5° to 90°C flexing)	7108A	25	250 †	76.2	71.5	32.5	.020	.51	.080	2.03	.665	16.89	370	1645	
			500 †	152.4	143.5	65.2									

20 AWG Stranded (74x38) Bare Copper Conductors • TC Braid Shield (85% Coverage) • Color Code: Red w/numbers + Green/Yellow ground

PVC Insulation • PVC Inner Jacket • Orange Oil- and Abrasion-resistant PVC Outer Jacket

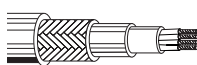
	UL AWM Style 2587 (600V 90°C) CSA AWM I/II A/B	7106AS	12	250 †	76.2	57.5	26.1	.020	.51	Inner: .025	.64	.535	13.59	194	863
				500 †	152.4	116.0	52.7			Outer: .055	1.40				
				Temp Rating: -40° to 90°C (-5° to 90°C flexing)											

18 AWG Stranded (114x38) Bare Copper Conductors • Unshielded • Color Code: Red w/numbers + Green/Yellow ground

PVC Insulation • Orange Oil- and Abrasion-resistant PVC Jacket

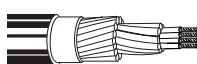
	UL AWM Style 2587 (600V 90°C) CSA AWM I/II A/B	7110A	3	500 †	152.4	26.0	11.8	.020	.51	.035	.89	.300	7.62	69	307
				1000 †	304.8	50.0	22.7								
				7113A	7	250 †	76.2	29.0	13.2	.020	.51	.060	1.52	.438	11.13
	500 †	152.4	55.5			25.2									
	1000 †	304.8	111.0	50.4											
7115A	12	250 †	76.2	40.3	18.3	.020	.51	.060	1.52	.513	13.03	270	1201		
		500 †	152.4	84.5	38.4										
7116A	18	250 †	76.2	63.0	28.6	.020	.51	.060	1.52	.598	15.19	400	1779		
		500 †	152.4	126.0	57.2										
Temp Rating: -40° to 90°C (-5° to 90°C flexing)	7117A	25	250 †	76.2	89.3	40.5	.020	.51	.083	2.11	.744	18.90	570	2535	
			500 †	152.4	179.0	81.3									

18 AWG Stranded (114x38) Bare Copper Conductors • TC Braid Shield (85% Coverage) • Color Code: Red w/numbers + Green/Yellow ground

PVC Insulation • PVC Inner Jacket • Orange Oil- and Abrasion-resistant PVC Outer Jacket

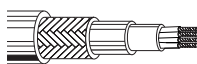
	UL AWM Style 2587 (600V 90°C) CSA AWM I/II A/B	7111AS	4	250 †	76.2	4.0	1.8	.020	.51	Inner: .025	.64	.405	10.29	84	373
				500 †	152.4	60.5	27.5			Outer: .050	1.27				
7115AS	12	250 †	76.2	72.8	33.1	.020	.51	Inner: .025	.64	.600	15.24	252	1121		
		500 †	152.4	144.5	65.6			Outer: .065	1.65						

PVC = Polyvinyl Chloride • TC = Tinned Copper

*Based on proper installation techniques in a C-track cable guide.

†Final put-up length may vary ±10% from length shown.

Belden Infinity® Flexible Automation Cable

600V C-TC+ Control Cables for Extreme Flexing

(9 Million Flex Cycles*)

Description	Part No.	No. of Cond.	Standard Lengths		Standard Unit Weight		Insulation Thickness		Jacket Thickness		Nominal OD		Maximum Pull Tension	
			Ft.	m	Lbs.	kg	Inch	mm	Inch	mm	Inch	mm	Lbs.	N

16 AWG Stranded (190x38) Bare Copper Conductors • Unshielded • Color Code: Red w/numbers + Green/Yellow ground

PVC Insulation • Orange Oil- and Abrasion-resistant PVC Jacket

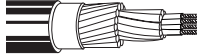
	UL AWM Style 2587 (600V 90°C) CSA AWM I/II A/B	7122A	3	250 †	76.2	16.3	7.4	.020	.51	.045	1.14	.325	8.26	114	507	
				500 †	152.4	43.5	19.8									
				1000 †	304.8	84.0	38.1									
		7125A	7	250 †	76.2	38.5	17.5	.020	.51	.060	1.52	.480	12.19	260	1156	
				500 †	152.4	73.5	33.4									
				1000 †	304.8	148.0	67.2									
		7126A	9	250 †	76.2	49.3	22.4	.020	.51	.060	1.52	.545	13.84	340	1512	
				500 †	152.4	108.6	44.8									
				1000 †	304.8	217.2	89.6									
		7127A	12	250 †	76.2	53.3	24.2	.020	.51	.060	1.52	.570	14.48	450	2001	
				500 †	152.4	122.5	55.6									
				1000 †	304.8	243.0	110.3									
		7128A	18	250 †	76.2	85.3	38.7	.020	.51	.060	1.52	.670	17.02	680	3025	
				500 †	152.4	172.0	78.1									
				1000 †	304.8	344.0	156.2									
		7129A	25	250 †	76.2	124.5	56.5	.020	.51	.080	2.03	.820	20.83	950	4226	
				500 †	152.4	247.5	112.4									
				1000 †	304.8	495.0	224.8									

Temp Rating: -40° to 90°C
(-5° to 90°C flexing)

16 AWG Stranded (190x38) BC Conductors • TC Braid Shield (85% Coverage) • Color Code: Red w/numbers + Green/Yellow ground

PVC Insulation • PVC Inner Jacket • Orange Oil- and Abrasion-resistant PVC Outer Jacket

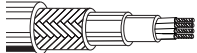
	UL AWM Style 2587 (600V 90°C) CSA AWM I/II A/B	7123AS	4	250 †	76.2	40.8	18.5	.020	.51	Inner: .025	.64	.420	10.67	154	685
				500 †	152.4	78.0	35.4			Outer: .040	1.02				
				1000 †	304.8	156.0	70.8								

Temp Rating: -40° to 90°C
(-5° to 90°C flexing)

14 AWG Stranded (266x38) Bare Copper Conductors • Unshielded • Color Code: Red w/numbers + Green/Yellow ground

PVC Insulation • Orange Oil- and Abrasion-resistant PVC Jacket

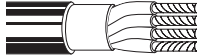
	UL AWM Style 2587 (600V 90°C) CSA AWM I/II A/B	7136A	4	250 †	76.2	39.0	17.7	.025	.64	.050	1.27	.430	10.92	212	943
				500 †	152.4	74.5	33.8								
				1000 †	304.8	149.0	67.6								

Temp Rating: -40° to 90°C
(-5° to 90°C flexing)

14 AWG Stranded (266x38) BC Conductors • TC Braid Shield (85% Coverage) • Color Code: Red w/numbers + Green/Yellow ground

PVC Insulation • PVC Inner Jacket • Orange Oil- and Abrasion-resistant PVC Outer Jacket

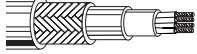
	UL AWM Style 2587 (600V 90°C) CSA AWM I/II A/B	7136AS	4	250 †	76.2	74.0	33.6	.025	.64	Inner: .025	.64	.500	12.70	208	925
				500 †	152.4	145.0	65.8			Outer: .045	1.14				
				1000 †	304.8	290.0	131.6								

Temp Rating: -40° to 90°C
(-5° to 90°C flexing)

12 AWG Stranded (413x38) Bare Copper Conductors • Unshielded • Color Code: Red w/numbers + Green/Yellow ground

PVC Insulation • Orange Oil- and Abrasion-resistant PVC Jacket

	UL AWM Style 2587 (600V 90°C) CSA AWM I/II A/B	7145A	4	250 †	76.2	72.5	32.9	.030	.76	.075	1.91	.545	13.84	274	1218
				500 †	152.4	146.0	66.3								
				1000 †	304.8	292.0	132.6								

Temp Rating: -40° to 90°C
(-5° to 90°C flexing)

BC = Bare Copper • TC = Tinned Copper

*Based on proper installation techniques in a C-track cable guide.

†Final put-up length may vary ±10% from length shown.

Belden Infinity® Flexible Automation Cable

600V FCC Control Cables for Moderate Flexing

(1 Million Flex Cycles*)

Description	Part No.	No. of Cond.	Standard Lengths		Standard Unit Weight		Insulation Thickness		Jacket Thickness		Nominal OD		Maximum Pull Tension	
			Ft.	m	Lbs.	kg	Inch	mm	Inch	mm	Inch	mm	Lbs.	N

20 AWG Stranded (10x30) Bare Copper Conductors • Unshielded • Color Code: Black w/numbers + Green/Yellow ground

PVC Insulation • Gray Oil- and Abrasion-resistant PVC Jacket

UL AWM Style 2587 (600V 90°C)
CSA AWM I/II A/B

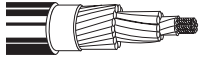

7400A	2	250 †	76.2	11.0	5.0	.022	.56	.040	1.02	.240	6.10	26	116
		500 †	152.4	25.0	11.4								
		1000 †	304.8	44.0	20.0								
7401A	3	250 †	76.2	13.0	5.9	.022	.56	.040	1.02	.250	6.35	39	173
		500 †	152.4	30.0	13.6								
		1000 †	304.8	59.0	26.8								
7402A	4	250 †	76.2	15.0	6.8	.022	.56	.040	1.02	.275	6.99	52	231
		500 †	152.4	33.0	15.0								
		1000 †	304.8	64.0	29.1								
7403A	5	250 †	76.2	17.5	8.0	.022	.56	.040	1.02	.300	7.62	65	289
		500 †	152.4	38.0	17.3								
		1000 †	304.8	72.0	32.7								
7404A	7	250 †	76.2	22.0	10.0	.022	.56	.040	1.02	.345	8.76	91	405
		500 †	152.4	44.5	20.2								
		1000 †	304.8	86.0	39.0								
7405A	9	250 †	76.2	29.5	13.4	.022	.56	.053	1.35	.410	10.41	117	520
		500 †	152.4	71.5	32.5								
		1000 †	304.8	144.0	65.4								
7406A	12	250 †	76.2	30.8	14.0	.022	.56	.053	1.35	.420	10.67	156	693
		500 †	152.4	88.5	40.2								
		1000 †	304.8	177.0	80.4								
7407A	18	250 †	76.2	53.5	24.3	.022	.56	.053	1.35	.500	12.70	234	1041
		500 †	152.4	104.0	47.2								
7408A	25	250 †	76.2	65.3	29.6	.022	.56	.065	1.65	.615	15.62	325	1445
		500 †	152.4	130.5	59.3								

Temp Rating: -40° to 90°C
(-5° to 90°C flexing)

20 AWG Stranded (10x30) BC Conductors • TC Braid Shield (85% Coverage) • Color Code: Black w/numbers + Green/Yellow ground

PVC Insulation • PVC Inner Jacket • Gray Oil- and Abrasion-resistant PVC Outer Jacket

UL AWM Style 2587 (600V 90°C)
CSA AWM I/II A/B

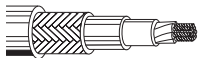

7401AS	3	500 †	152.4	54.0	24.5	.022	.56	Inner: .320		8.13	45	200
								Outer: .64				
								.035 .89				
7402AS	4	250 †	76.2	32.8	14.9	.022	.56	Inner: .330		8.38	52	231
		500 †	152.4	64.0	29.1			Outer: .64				
								.035 .89				
7403AS	5	250 †	76.2	34.8	15.8	.022	.56	Inner: .370		9.40	65	289
		500 †	152.4	68.0	30.9			Outer: .64				
								.035 .89				
7404AS	7	250 †	76.2	37.8	17.1	.022	.56	Inner: .420		10.67	91	405
		500 †	152.4	71.5	32.5			Outer: .64				
								.040 1.02				

Temp Rating: -40° to 90°C
(-5° to 90°C flexing)

BC = Bare Copper • TC = Tinned Copper

*Based on proper installation techniques in a C-track cable guide.

†Final put-up length may vary ±10% from length shown.

Belden Infinity® Flexible Automation Cable

600V FCC Control Cables for Moderate Flexing

(1 Million Flex Cycles*)

Description	Part No.	No. of Cond.	Standard Lengths		Standard Unit Weight		Insulation Thickness		Jacket Thickness		Nominal OD		Maximum Pull Tension	
			Ft.	m	Lbs.	kg	Inch	mm	Inch	mm	Inch	mm	Lbs.	N

18 AWG Stranded (16x30) Bare Copper Conductors • Unshielded • Color Code: Black w/numbers + Green/Yellow ground

PVC Insulation • Gray Oil- and Abrasion-resistant PVC Jacket

UL AWM Style 2587 (600V 90°C)
CSA AWM I/II A/B

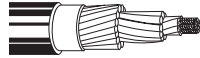

7409A	2	250 †	76.2	13.3	6.0	.022	.56	.040	1.02	.264	6.71	50	222
		500 †	152.4	26.5	12.0								
		1000 †	304.8	51.0	23.2								
7410A	3	250 †	76.2	16.3	7.4	.022	.56	.040	1.02	.280	7.11	74	329
		500 †	152.4	25.0	11.4								
		1000 †	304.8	48.0	21.8								
7411A	4	250 †	76.2	18.8	8.5	.022	.56	.040	1.02	.305	7.75	98	436
		500 †	152.4	31.0	14.1								
		1000 †	304.8	58.0	26.3								
7412A	5	250 †	76.2	21.8	9.9	.022	.56	.040	1.02	.330	8.38	122	542
		500 †	152.4	36.0	16.3								
		1000 †	304.8	69.0	31.3								
7413A	7	250 †	76.2	27.5	12.5	.022	.56	.040	1.02	.385	9.78	171	760
		500 †	152.4	46.0	20.9								
		1000 †	304.8	120.0	54.5								
7414A	9	250 †	76.2	36.5	16.6	.022	.56	.050	1.27	.452	11.48	220	978
		500 †	152.4	87.0	39.5								
		1000 †	304.8	174.0	79.0								
7415A	12	250 †	76.2	40.0	18.2	.022	.56	.050	1.27	.475	12.07	292	1298
		500 †	152.4	75.5	34.3								
		1000 †	304.8	161.0	73.1								
7416A	18	250 †	76.2	55.8	25.3	.022	.56	.050	1.27	.560	14.22	440	1957
		500 †	152.4	112.5	51.1								
7417A	25	250 †	76.2	74.3	33.7	.022	.56	.072	1.83	.696	17.68	520	2313
		500 †	152.4	149.0	67.6								
7418A	34	250 †	76.2	111.3	50.5	.022	.56	.072	1.83	.788	20.02	830	3692
		500 †	152.4	215.5	97.8								
7419A	41	500 †	152.4	295.0	133.9	.022	.56	.075	1.91	.860	21.84	1001	4453
7420A	50	250 †	76.2	186.5	84.7	.022	.56	.083	2.11	.940	23.88	1220	5427

Temp Rating: -40° to 90°C
(-5° to 90°C flexing)

18 AWG Stranded (16x30) BC Conductors • TC Braid Shield (85% Coverage) • Color Code: Black w/numbers + Green/Yellow ground

PVC Insulation • PVC Inner Jacket • Gray Oil- and Abrasion-resistant PVC Outer Jacket

UL AWM Style 2587 (600V 90°C)
CSA AWM I/II A/B

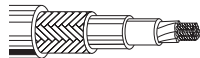

7411AS	4	250 †	76.2	29.0	13.2	.022	.56	Inner: .025	.64	.365	9.27	83	369
		500 †	152.4	56.5	25.7			Outer: .032	.81				
7413AS	7	250 †	76.2	37.5	17.0	.022	.56	Inner: .025	.64	.450	11.43	145	645
		500 †	152.4	74.0	33.6			Outer: .035	.89				
7415AS	12	250 †	76.2	61.5	27.9	.022	.56	Inner: .025	.64	.550	13.97	230	1023
		500 †	152.4	124.0	56.3			Outer: .045	1.14				
7416AS	18	250 †	76.2	83.3	37.8	.022	.56	Inner: .025	.64	.650	16.51	374	1663
		500 †	152.4	169.0	76.7			Outer: .055	1.40				
7417AS	25	250 †	76.2	113.8	51.6	.022	.56	Inner: .025	.64	.765	19.43	520	2313
		500 †	152.4	228.0	103.5			Outer: .060	1.52				

Temp Rating: -40° to 90°C
(-5° to 90°C flexing)

BC = Bare Copper • TC = Tinned Copper

*Based on proper installation techniques in a C-track cable guide.

†Final put-up length may vary ±10% from length shown.

Belden Infinity® Flexible Automation Cable

600V FCC Control Cables for Moderate Flexing

(1 Million Flex Cycles*)

Description	Part No.	No. of Cond.	Standard Lengths		Standard Unit Weight		Insulation Thickness		Jacket Thickness		Nominal OD		Maximum Pull Tension	
			Ft.	m	Lbs.	kg	Inch	mm	Inch	mm	Inch	mm	Lbs.	N

16 AWG Stranded (26x30) Bare Copper Conductors • Unshielded • Color Code: Black w/numbers + Green/Yellow ground

PVC Insulation • Gray Oil- and Abrasion-resistant PVC Jacket

UL AWM Style 2587 (600V 90°C)
CSA AWM I/II A/B

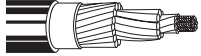

7421A	2	250 †	76.2	15.0	6.8	.022	.56	.040	1.02	.290	7.37	70	311
		500 †	152.4	35.0	15.9								
		1000 †	304.8	68.0	30.9								
7422A	3	250 †	76.2	18.8	8.5	.022	.56	.040	1.02	.305	7.75	105	467
		500 †	152.4	34.5	15.7								
		1000 †	304.8	65.0	29.5								
7423A	4	250 †	76.2	22.5	10.2	.022	.56	.040	1.02	.330	8.38	140	623
		500 †	152.4	41.5	18.8								
		1000 †	304.8	80.0	36.3								
7424A	5	250 †	76.2	27.5	12.5	.022	.56	.040	1.02	.360	9.14	175	778
		500 †	152.4	49.5	22.5								
		1000 †	304.8	96.0	43.6								
7425A	7	250 †	76.2	35.0	15.9	.022	.56	.040	1.02	.425	10.80	236	1050
		500 †	152.4	64.0	29.1								
		1000 †	304.8	129.0	58.6								
7426A	9	250 †	76.2	50.5	22.9	.022	.56	.060	1.52	.540	13.72	304	1352
		500 †	152.4	95.0	43.1								
		1000 †	304.8	190.0	86.3								
7427A	12	250 †	76.2	55.3	25.1	.022	.56	.065	1.65	.565	14.35	405	1801
		500 †	152.4	114.0	51.8								
		1000 †	304.8	220.0	100.0								
7428A	18	250 †	76.2	79.0	35.9	.022	.56	.065	1.65	.650	16.51	608	2705
		500 †	152.4	158.0	71.7								
7429A	25	250 †	76.2	109.0	49.5	.022	.56	.060	1.52	.750	19.05	875	3892
		500 †	152.4	218.5	99.2								
7430A	34	250 †	76.2	171.3	77.7	.022	.56	.075	1.91	.878	22.30	1145	5093

Temp Rating: -40° to 90°C
(-5° to 90°C flexing)

16 AWG Stranded (26x30) BC Conductors • TC Braid Shield (85% Coverage) • Color Code: Black w/numbers + Green/Yellow ground

PVC Insulation • PVC Inner Jacket • Gray Oil- and Abrasion-resistant PVC Outer Jacket

UL AWM Style 2587 (600V 90°C)
CSA AWM I/II A/B

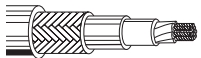

7423AS	4	250 †	76.2	36.0	16.3	.022	.56	Inner: .025	.64	.400	10.16	140	623
		500 †	152.4	68.0	30.9			Outer: .035	.89				
7427AS	12	250 †	76.2	81.8	37.1	.022	.56	Inner: .025	.64	.630	16.00	420	1868
		500 †	152.4	164.5	74.7			Outer: .060	1.52				
7428AS	18	250 †	76.2	119.0	54.1	.022	.56	Inner: .025	.64	.740	18.80	630	2802
		500 †	152.4	238.5	108.3			Outer: .070	1.78				

Temp Rating: -40° to 90°C
(-5° to 90°C flexing)

BC = Bare Copper • TC = Tinned Copper

*Based on proper installation techniques in a C-track cable guide.

†Final put-up length may vary ±10% from length shown.

Belden Infinity® Flexible Automation Cable

600V FCC Control Cables for Moderate Flexing

(1 Million Flex Cycles*)

Description	Part No.	No. of Cond.	Standard Lengths		Standard Unit Weight		Insulation Thickness		Jacket Thickness		Nominal OD		Maximum Pull Tension	
			Ft.	m	Lbs.	kg	Inch	mm	Inch	mm	Inch	mm	Lbs.	N

14 AWG Stranded (41x30) Bare Copper Conductors • Unshielded • Color Code: Black w/numbers + Green/Yellow ground

PVC Insulation • Gray Oil- and Abrasion-resistant PVC Jacket

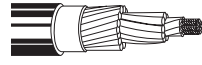
	UL AWM Style 2587 (600V 90°C) CSA AWM I/II A/B	7434A	2	250 †	76.2	34.0	15.5	.023	.58	.045	1.14	.335	8.51	201	894	
				500 †	152.4	66.5	30.2									
				1000 †	304.8	92.0	41.8									
		7435A	3	250 †	76.2	39.8	18.1	.023	.58	.045	1.14	.350	8.89	201	894	
				500 †	152.4	78.5	35.6									
				1000 †	304.8	98.0	44.5									
		7436A	4	250 †	76.2	49.3	22.4	.023	.58	.050	1.27	.395	10.03	201	894	
				500 †	152.4	95.0	43.1									
				1000 †	304.8	131.0	59.5									
		7438A	7	500 †	152.4	150.5	68.3	.023	.58	.060	1.52	.525	13.33	373	1659	
				500 †	76.2	110.8	50.3	.023	.58	.070	1.78	.620	15.75	480	2135	
					152.4	223.0	101.2									
		7440A	12	250 †	76.2	142.5	64.7	.023	.58	.075	1.91	.660	16.76	640	2847	
				500 †	152.4	285.5	129.6									
				500 †	152.4	285.5	129.6									
		7442A	25	250 †	76.2	223.8	101.7	.023	.58	.090	2.29	.930	23.62	1337	5947	

Temp Rating: -40° to 90°C
(-5° to 90°C flexing)

14 AWG Stranded (41x30) BC Conductors • TC Braid Shield (85% Coverage) • Color Code: Black w/numbers + Green/Yellow ground

PVC Insulation • PVC Inner Jacket • Gray Oil- and Abrasion-resistant PVC Outer Jacket

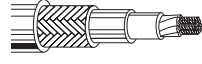
	UL AWM Style 2587 (600V 90°C) CSA AWM I/II A/B	7436AS	4	250 †	76.2	49.3	22.4	.023	.58	Inner: .025	.64	.482	12.24	212	943
				500 †	152.4	95.0	43.1			Outer: .055	1.40				
		7438AS	7	250 †	76.2	74.8	33.9	.023	.58	Inner: .025	.64	.563	14.30	371	1650
				500 †	152.4	150.5	68.3			Outer: .060	1.52				

Temp Rating: -40° to 90°C
(-5° to 90°C flexing)

12 AWG Stranded (65x30) Bare Copper Conductors • Unshielded • Color Code: Black w/numbers + Green/Yellow ground

PVC Insulation • Gray Oil- and Abrasion-resistant PVC Jacket

	UL AWM Style 2587 (600V 90°C) CSA AWM I/II A/B	7444A	3	250 †	76.2	53.5	24.3	.028	.71	.060	1.52	.450	11.43	253	1125	
				500 †	152.4	103.5	47.0									
		7445A	4	250 †	76.2	63.5	28.8	.028	.71	.070	1.78	.505	12.83	338	1503	
				500 †	152.4	124.0	56.3									

Temp Rating: -40° to 90°C
(-5° to 90°C flexing)

12 AWG Stranded (65x30) BC Conductors • TC Braid Shield (85% Coverage) • Color Code: Black w/numbers + Green/Yellow ground

PVC Insulation • PVC Inner Jacket • Gray Oil- and Abrasion-resistant PVC Outer Jacket

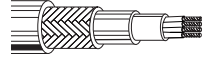
	UL AWM Style 2587 (600V 90°C) CSA AWM I/II A/B	7445AS	4	250 †	76.2	85.8	38.9	.028	.71	Inner: .030	.76	.580	14.73	338	1503
				500 †	152.4	171.5	77.9			Outer: .070	1.78				

Temp Rating: -40° to 90°C
(-5° to 90°C flexing)

BC = Bare Copper • TC = Tinned Copper

*Based on proper installation techniques in a C-track cable guide.

†Final put-up length may vary ±10% from length shown.

Belden Infinity® Flexible Automation Cable

600V FCC Control Cables for Moderate Flexing

(1 Million Flex Cycles*)

Description	Part No.	No. of Cond.	Standard Lengths		Standard Unit Weight		Insulation Thickness		Jacket Thickness		Nominal OD		Maximum Pull Tension	
			Ft.	m	Lbs.	kg	Inch	mm	Inch	mm	Inch	mm	Lbs.	N

10 AWG Stranded (105x30) Bare Copper Conductors • Unshielded (Color Code: Black w/numbers + Green/Yellow ground)

PVC Insulation • Gray Oil- and Abrasion-resistant PVC Jacket

UL AWM Style 2587 (600V 90°C)	7447A	4	250 †	76.2	70.8	32.1	.030	.76	.070	1.78	.570	14.48	672	2989
CSA AWM I/II A/B			500 †	152.4	142.5	64.7								

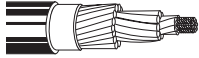

Temp Rating: -40° to 90°C
(-5° to 90°C flexing)

10 AWG Stranded (105x30) BC Conductors • TC Braid Shield (85% Coverage) • Color Code: Black w/numbers + Green/Yellow ground

PVC Insulation • PVC Inner Jacket • Gray Oil- and Abrasion-resistant PVC Outer Jacket

UL AWM Style 2587 (600V 90°C)	7447AS	4	250 †	76.2	92.8	42.2	.030	.76	Inner:	.660	16.76	546	2429
CSA AWM I/II A/B			500 †	152.4	185.5	84.3			Outer:	.035	.89		
										.065	1.65		

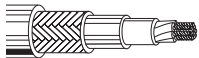

Temp Rating: -40° to 90°C
(-5° to 90°C flexing)

8 AWG Stranded (168x30) Bare Copper Conductors • Unshielded • Color Code: Black w/numbers + Green/Yellow ground

PVC Insulation • Gray Oil- and Abrasion-resistant PVC Jacket

UL AWM Style 2587 (600V 90°C)	7450A	4	250 †	76.2	113.8	51.6	.045	1.14	.070	1.78	.715	18.16	920	4092
CSA AWM I/II A/B			500 †	152.4	228.0	103.5								

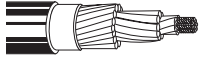

Temp Rating: -40° to 90°C
(-5° to 90°C flexing)

8 AWG Stranded (168x30) BC Conductors • TC Braid Shield (85% Coverage) • Color Code: Black w/numbers + Green/Yellow ground

PVC Insulation • PVC Inner Jacket • Gray Oil- and Abrasion-resistant PVC Outer Jacket

UL AWM Style 2587 (600V 90°C)	7450AS	4	250 †	76.2	141.3	64.1	.045	1.14	Inner:	.815	20.70	872	3879
CSA AWM I/II A/B			500 †	152.4	281.0	127.6			Outer:	.040	1.02		
										.065	1.65		

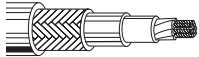

Temp Rating: -40° to 90°C
(-5° to 90°C flexing)

6 AWG Stranded (266x30) Bare Copper Conductors • Unshielded • Color Code: Black w/numbers + Green/Yellow ground

PVC Insulation • Gray Oil- and Abrasion-resistant PVC Jacket

UL AWM Style 2587 (600V 90°C)	7453A	4	250 †	76.2	185.0	84.0	.060	1.52	.085	2.16	.925	23.50	1472	6548
CSA AWM I/II A/B														

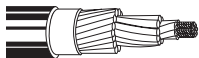

Temp Rating: -40° to 90°C
(-5° to 90°C flexing)

BC = Bare Copper • TC = Tinned Copper

*Based on proper installation techniques in a C-track cable guide.

†Final put-up length may vary ±10% from length shown.

Belden Infinity® Flexible Automation Cable

300V Flex Data Cables

(1 Million Flex Cycles*)

Description	Part No.	No. of Pairs	UL NEC/ C(UL) CEC Type	RS Type	Color Code	Standard Lengths		Standard Unit Weight		Nominal OD		Maximum Capacitance		Nom. Imped. (Ω)	
						Ft.	m	Lbs.	kg	Inch	mm	pF/Ft.	pF/m		
Flex Data • 24 AWG Stranded (41x40) BC Condrs. • Twisted Pairs • Overall Beldfoil® (100% Coverage) + TC Braid Shield (85% Coverage)**															
Foam Polyethylene Insulation with Skin • Green Oil-resistant PVC Jacket															
	300V 60°C	7200A	1	NEC: CM CEC: CM	232 485	White, Blue	500 1000	152.4 304.8	17.0 38.0	7.7 17.3	.240	6.10	15.0	49.2	120
		7201A	2	NEC: CM CEC: CM	232 485	See Color Code Chart (below)	500 1000	152.4 304.8	31.0 60.0	14.1 27.2	.322	8.18	15.0	49.2	120
		7202A	3	NEC: CM CEC: CM	232 485	See Color Code Chart (below)	500 1000	152.4 304.8	33.5 68.0	15.2 30.9	.347	8.81	15.0	49.2	120
		7203A	4	NEC: CM CEC: CM	232 485	See Color Code Chart (below)	500 1000	152.4 304.8	39.0 79.0	17.7 35.9	.362	9.20	15.0	49.2	120
		7205A	1	NEC: CM CEC: CM	232 422	White, Blue	500 1000	152.4 304.8	17.5 38.0	7.9 17.3	.232	5.89	14.0	45.9	100
		7206A	1	NEC: CM CEC: CM	232 485	White, Blue	1000	304.8	59.0	26.8	.302	7.67	10.0	32.8	150

Temp Rating: -20° to 60°C
(-5° to 60°C flexing)

BC = Bare Copper • TC = Tinned Copper

*Based on proper installation techniques in a C-track cable guide.

**24 AWG stranded (41x40) tinned copper drain wire.

Color Codes: Flex Data

Pair No.	Color Combination
1	White/Blue Stripe & Blue/White Stripe
2	White/Orange Stripe & Orange/White Stripe
3	White/Green Stripe & Green/White Stripe
4	White/Brown Stripe & Brown/White Stripe

Belden Infinity® Flexible Automation Cable

75 Ohm Flex Vision Coax Cables

(1 Million Flex Cycles*)

Description	Part No.	UL NEC/ C(UL) CEC Type	Standard Lengths		Standard Unit Weight		Nom. DCR		Nominal Core OD		Nominal OD		Nom. Imp. (Ω)	Nom. Vel. of Prop.	Nominal Capacitance		Nominal Attenuation		
			Ft.	m	Lbs.	kg	Conductor	Shield	Inch	mm	Inch	mm			pF/Ft.	pF/m	MHz	dB/100 Ft.	dB/100m

Sub-Mini Type • 30 AWG Stranded (7x38) Tinned Cadmium Bronze Conductor • Tinned Copper “French Braid” Shield (95% Coverage)

Foam Polyethylene Insulation • Matte Blue Belflex® Jacket

UL AWM	7500A	CEC:	250†	76.2	3.0	1.4	108.0Ω/M'	13.3Ω/M'	.056	1.42	.110	2.79	75	78%	16.7	54.8	2.2	.9	2.95
Style 1354		FT1	500†	152.4	5.0	2.3	354.3Ω/km	43.6Ω/km									5	1.4	4.59
30V 80°C			1000†	304.8	9.0	4.1											10	2.0	6.56
CSA AWM I/II A/B																	30	3.4	11.16
																	50	4.4	14.44
																	100	6.4	21.00

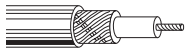

Mini Type • 25 AWG Stranded (19x38) Bare Copper Conductor • Tinned Copper “French Braid” Shield (95% Coverage)

Foam Polyethylene Insulation • Matte Blue Belflex Jacket

UL AWM	7501A	CEC:	500†	152.4	7.5	3.4	35.0Ω/M'	9.1Ω/M'	.090	2.29	.146	3.71	75	77%	17.7	58.1	2.2	.6	1.97
Style 1354		FT1	1000†	304.8	14.0	6.4	114.8Ω/km	29.9Ω/km									5	.9	2.95
30V 80°C																	10	1.3	4.27
CSA AWM I/II A/B																	30	2.2	7.22
																	50	2.9	9.52
																	100	4.2	13.78

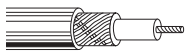

RG-59 Type • 22 AWG Stranded (19x34) Bare Copper Conductor • Tinned Copper “French Braid” Shield (95% Coverage)

Foam Polyethylene Insulation • Matte Blue Belflex Jacket

UL AWM	7502A	CEC:	250†	76.2	10.5	4.8	13.4Ω/M'	6.4Ω/M'	.146	3.71	.242	6.15	75	79%	18.0	59.1	2.2	.4	1.31
Style 1354		FT1	500†	152.4	15.0	6.8	44.0Ω/km	21.0Ω/km									5	.5	1.64
30V 80°C			1000†	304.8	34.0	15.4											10	.8	2.63
CSA AWM I/II A/B																	30	1.4	4.59
																	50	1.8	5.91
																	100	2.7	8.86



RG-6/U Type • 20 AWG Stranded (7x15x40) Bare Copper Conductor • Tinned Copper “French Braid” Shield (95% Coverage)

Foam Polyethylene Insulation • Matte Blue Belflex Jacket

UL AWM	7503A	CEC:	250†	76.2	12.0	5.5	8.1Ω/M'	11.0Ω/M'	.185	4.70	.275	6.99	75	80%	17.3	56.8	2.2	.3	0.98
Style 1354		FT1	500†	152.4	18.0	8.2	26.6Ω/km	36.1Ω/km									5	.4	1.31
30V 80°C			1000†	304.8	40.0	18.2											10	.6	1.97
CSA AWM I/II A/B																	30	1.1	3.61
																	50	1.5	4.92
																	100	2.2	7.22

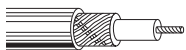

RG-11 Type • 16 AWG Stranded (7x37x40) Bare Copper Conductor • Tinned Copper “French Braid” Shield (95% Coverage)

Foam Polyethylene Insulation • Matte Blue Belflex Jacket

UL AWM	7504A	CEC:	1000†	304.8	84.0	38.1	3.5Ω/M'	3.6Ω/M'	.285	7.24	.405	10.29	75	81%	17.3	56.8	2.2	.2	0.66
Style 1354		FT1					11.5Ω/km	11.8Ω/km									5	.3	0.98
30V 80°C																	10	.4	1.31
CSA AWM I/II A/B																	30	.8	2.63
																	50	1.0	3.28
																	100	1.5	4.92



BC = Bare Copper • DCR = DC Resistance • TC = Tinned Copper

*Based on proper installation techniques in a C-track cable guide.

†Final put-up length may vary ±10% from length shown.

UL Instrumentation Cable

300V Power-Limited Tray Cables — Overview

Construction

Soft annealed bare or tinned copper with PVC flame retardant insulation and jacket. Other insulation and jacket options are available (see table below). Communication wire included on all multi-pair/multi-triad 1000 and 3000 series part numbers, 22 AWG (7x30) bare copper, orange PVC insulation. Nylon rip cord included in all PVC/PVC instrumentation cables.

Other Construction Options:

UL Listed for PLTC	
Insulation/Jacket	Max. Temp Rating
XLPE/PVC	90°C
XLPE/CPE	90°C
PVC/PVC	105°C
PVC/CPE	105°C
PE/PVC	75°C
FPE/PVC	75°C
TPE/TPE	105°C
XLPE/Haloarrest®	90°C

Armoring Capabilities

Belden also has the capability to protect electronic, instrumentation and control cables with interlocking or continuous armor and smooth or corrugated protective metal tapes.

To Specify Part Number		
1	2	3456
Overall Jacket Type	Armor Type	Core Trade Number

Overall Jacket

Code	Material
1	PVC
3	CPE
4	TPE
5	HDPE
6	Oil Res II
7	Haloarrest® I

Armor

Code	Material
2	Aluminum Interlock
3	Steel Interlock
8	Continuously Corrugated Aluminum

Application

Cable jackets are resistant to sunlight, moisture and vapor penetration. PVC/PVC constructions, with 3 conductors or more and 20 AWG or larger, are suitable for direct burial.

Unshielded

Twisted non-shielded pairs and triads provide a minimal OD allowing greater tray and conduit fill. Non-shielded instrument pairs may be utilized when recommended by the instrument manufacturer and used in a metallic conduit.

Overall Shield

Recommended for use in instrumentation applications where signals are transmitted in excess of 100 millivolts except in areas where high voltage and current sources create excessive noise interference. The Beldfoil® shield with drain wire provides 100% coverage for maximum shield effectiveness.

Individually Shielded and Overall Shielded

Individually shielded pairs or triads with an overall shield are recommended for use in instrumentation applications where optimum noise rejection is required. Individual pair/triad shields are fully isolated from each other and contain a separate drain wire for grounding, to provide maximum protection from crosstalk and common mode interference. Cables with an overall shield provide additional electrostatic noise protection.

Specifications

- UL Subject 13
- UL Subject 2250
- NEC Article 725 Class 2 and Class 3 Circuits
- NEC Type PLTC Listed, which is approved for cable tray use in Class 1, Division 2, hazardous areas and non-hazardous areas, cable trays, raceways, conduit and supported by messenger wires.
- Sunlight-resistant.
- Oil-resistant per UL Class 43
- NEC Type ITC per Article 727. ITC cables may carry up to 5 amps at 150V, which is significantly greater than that allowed for PLTC only cables. ITC cables may also be installed in specific applications, per the NEC, in addition to those allowed for PLTC.
- UL 1685 (UL 1581) Vertical Tray Flame Test comparable to IEEE 383-1974 (70,000 BTU/hr.) Flame Test.
- PVC/PVC constructions are CMG, FT4, IEEE 1202 and IEEE 383-2003 rated, and meet ICEA T-29-520 Flame Test.
- Design options — call 1-800-BELDEN-1 or 1-800-BELDEN-3.

PLTC-ER

As an option, Belden offers all PVC insulated, PVC jacketed instrumentation cables, and several other insulation and jackets, with a PLTC-ER (Exposed Run) rating, formerly referred to as Open Wiring.

Per NEC Article 725, a PLTC-ER rated cable may be installed in an industrial establishment between a cable tray and the utilization equipment or device. A PLTC-ER rated cable must meet the crush and impact requirements of UL Type MC cable. By eliminating the need for metal conduit and/or armor, using a PLTC-ER rated cable results in savings in both installation and maintenance.

Standard lengths may be subject to tolerance. Custom lengths may be available upon request. Contact the Belden Electronics Division Customer Service Department for additional information. 1-800-BELDEN-1 or 1-800-BELDEN-3.

UL Instrumentation Cable

300V Power-Limited Tray Cables

Industrial Grade Sunlight- and Oil-Resistant Jackets

Description	Part No.	No. of Pairs	Color Code	Standard Lengths		Standard Unit Weight		Jacket Thickness		Nominal OD		Maximum Pull Tension		Minimum Bend Radius	
				Ft.	m	Lbs.	kg	Inch	mm	Inch	mm	Lbs.	N	Inch	mm

22 AWG Pairs Stranded (7x30) Tinned Copper Conductors • Twisted Pairs

Unshielded • PVC Insulation • Chrome PVC Jacket

NEC: PLTC, ITC, CMG CEC: CMG FT4 IEEE 1202/383 ICEA T-29-520	9407	1	E2	U-500 U-1000	U-152.4 U-304.8	10.0 19.0	4.3 8.2	.037	.94	.198	5.03	19	84	2.00	50.80
---	-------------	---	----	-----------------	--------------------	--------------	------------	------	-----	------	------	----	----	------	-------

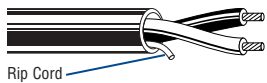

Overall Beldfoil® Shield (100% Coverage) • PVC Insulation • Chrome PVC Jacket

NEC: PLTC, ITC, CMG CEC: CMG FT4 IEEE 1202/383 ICEA T-29-520	9322	1	E2	U-500 U-1000	U-152.4 U-304.8	11.0 22.0	5.0 10.0	.037	.94	.201	5.10	28	124	2.00	50.80
	9512	2	E2	500 1000	152.4 304.8	22.0 42.0	10.0 19.1	.042	1.07	.310	7.82	46	204	3.00	76.20
	9513	3	E2	500 1000	152.4 304.8	26.5 51.0	11.6 23.2	.042	1.07	.324	8.23	63	280	3.25	82.55
	9514	4	E2	500 1000	152.4 304.8	33.0 67.0	14.8 30.5	.042	1.07	.356	9.04	80	355	3.50	88.90
	9516	6	E2	500 1000	152.4 304.8	45.0 89.0	20.4 40.4	.053	1.35	.418	10.62	118	524	4.25	107.95
	9520	9	E2	500 1000	152.4 304.8	64.5 121.0	29.3 55.0	.053	1.35	.482	12.29	172	765	4.75	120.65
	9521	11	E2	500 1000	152.4 304.8	73.0 147.0	32.7 66.4	.053	1.35	.506	12.85	200	889	5.35	135.89
	9524	15	E2	500 1000	152.4 304.8	89.5 178.0	40.7 80.9	.053	1.35	.594	15.09	280	1245	6.00	152.40
	9526	19	E2	500 1000	152.4 304.8	114.5 224.0	52.0 101.8	.063	1.60	.644	16.36	350	1557	6.33	160.78
	9527	27	E2	500 1000 †	152.4 304.8	156.5 321.0	71.1 145.9	.063	1.60	.763	19.38	500	2224	7.50	190.50

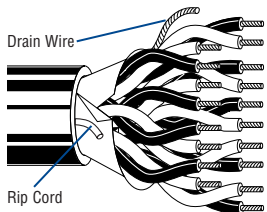

22 AWG Pairs Stranded (7x30) Bare Copper Conductors* • Twisted Pairs

Overall Beldfoil Shield (100% Coverage) • PVC Insulation • PVC Jacket (Black or Chrome)

NEC: PLTC, ITC, CMG CEC: CMG FT4 IEEE 1202/383 ICEA T-29-520	3000A**	2	E1	Bulk††	Bulk	—	—	.043	1.09	.310	7.87	46	204	3.00	76.20
	3004A**	4	E1	Bulk††	Bulk	—	—	.042	1.07	.357	9.01	80	355	3.50	88.90
	3006A**	8	E1	Bulk††	Bulk	—	—	.053	1.35	.450	11.43	172	765	4.75	120.65
	3008A**	12	E1	Bulk††	Bulk	—	—	.053	1.35	.536	13.61	210	934	5.00	127.00
	3010A**	16	E1	Bulk††	Bulk	—	—	.053	1.35	.594	15.09	290	1290	6.00	152.40
	3012A**	24	E1	Bulk††	Bulk	—	—	.065	1.65	.749	19.02	440	1957	7.50	190.50
	3014A**	50	E1	Bulk††	Bulk	—	—	.075	1.91	1.017	25.80	915	4070	9.50	241.30

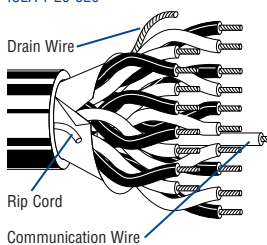

PVC = Polyvinyl Chloride

*For tinned copper conductors, order with B suffix.

**For Exposed Run rated cable (3000 series only), order with E suffix, e.g. 3000AE.

†Final put-up length may vary ±10% from length shown.

††Bulk = Check length available for specific construction.

E1, E2 = Refer to Industrial Technical Information section for color code. Alternate color coding available upon request.

Multiple pair or triad cables have each pair/triad numbered for ease of identification.



UL Instrumentation Cable

300V Power-Limited Tray Cables

Industrial Grade Sunlight- and Oil-Resistant Jackets

Description	Part No.	No. of Pairs/Triads	Color Code	Standard Lengths		Standard Unit Weight		Jacket Thickness		Nominal OD		Maximum Pull Tension		Minimum Bend Radius	
				Ft.	m	Lbs.	kg	Inch	mm	Inch	mm	Lbs.	N	Inch	mm

22 AWG Pairs Stranded (7x30) Tinned Copper Conductors • Twisted Pairs

Individually Shielded • PVC Insulation • Chrome PVC Jacket															
NEC: PLTC, ITC, CMG CEC: CMG FT4 IEEE 1202/383 ICEA T-29-520	9328	2	E2	500	152.4	23.5	10.2	.042	1.07	.323	8.20	54	240	3.00	76.20
				1000	304.8	46.0	20.9								
	9329	3	E2	500	152.4	29.5	13.4	.042	1.07	.341	8.66	54	240	3.50	88.90
				1000	304.8	60.0	27.3								
	9330	4	E2	500	152.4	39.0	17.7	.042	1.07	.372	9.45	110	489	3.50	88.90
				1000	304.8	75.0	34.0								
	9331	6	E2	500	152.4	55.0	24.5	.053	1.35	.457	11.61	101	449	4.33	109.98
				1000	304.8	111.0	50.4								
	9332	9	E2	500	152.4	75.0	34.1	.053	1.35	.530	13.46	160	711	5.00	127.00
				1000	304.8	145.0	65.9								
	9333	11	E2	500	152.4	89.0	40.5	.053	1.35	.592	15.04	160	711	5.50	139.70
				1000	304.8	177.0	80.5								
	9335	19	E2	500	152.4	141.5	64.3	.063	1.60	.711	18.06	264	1174	6.50	165.10
				1000	304.8	287.0	130.5								

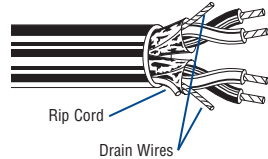

22 AWG Pairs Stranded (7x30) Bare Copper Conductors* • Twisted Pairs

Individually Shielded + Overall Beldfoil® Shield (100% Coverage) • PVC Insulation • PVC Jacket (Black or Chrome)															
NEC: PLTC, ITC, CMG CEC: CMG FT4 IEEE 1202/383 ICEA T-29-520	3001A [†]	2	E1	Bulk ^{††}	Bulk	—	—	.042	1.07	.324	8.23	54	240	3.25	82.55
	3005A [†]	4	E1	Bulk ^{††}	Bulk	—	—	.043	1.09	.360	9.14	115	511	3.50	88.90
	3007A [†]	8	E1	Bulk ^{††}	Bulk	—	—	.053	1.35	.497	12.62	250	1112	5.25	133.35
	3009A [†]	12	E1	Bulk ^{††}	Bulk	—	—	.053	1.35	.570	14.48	300	1334	5.75	146.05
	3011A [†]	16	E1	Bulk ^{††}	Bulk	—	—	.064	1.63	.674	17.12	350	1557	6.25	158.75
	3013A [†]	24	E1	Bulk ^{††}	Bulk	—	—	.065	1.65	.800	20.32	540	2402	8.00	203.20
	3015A [†]	50	E1	Bulk ^{††}	Bulk	—	—	.075	1.91	1.050	26.67	1330	5916	10.50	266.70

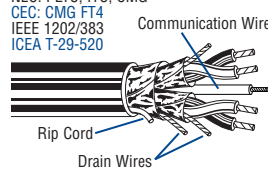

22 AWG Triads Stranded (7x30) Tinned Copper Conductors • Twisted Triads

Unshielded • PVC Insulation • Chrome PVC Jacket															
NEC: PLTC, ITC, CMG CEC: CMG FT4 IEEE 1202/383 ICEA T-29-520	9491	1	E1	U-500	U-152.4	12.5	5.7	.037	.94	.208	5.28	29	129	2.00	50.80
				U-1000	U-304.8	23.0	10.4								

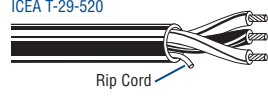

Overall Beldfoil Shield (100% Coverage) • PVC Insulation • Chrome PVC Jacket															
NEC: PLTC, ITC, CMG CEC: CMG FT4 IEEE 1202/383 ICEA T-29-520	9363	1	E1	U-500	U-152.4	13.5	6.1	.037	.94	.208	5.28	29	129	2.00	50.80
				U-1000	U-304.8	26.0	11.8								

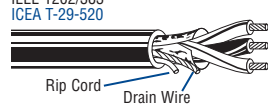

22 AWG Triads Stranded (7x30) Bare Copper Conductors* • Twisted Triads

Overall Beldfoil Shield (100% Coverage) • PVC Insulation • PVC Jacket (Black or Chrome)															
NEC: PLTC, ITC, CMG CEC: CMG FT4 IEEE 1202/383 ICEA T-29-520	3002A	2	E1	Bulk ^{††}	Bulk	—	—	.043	1.09	.330	8.38	62	275	3.50	88.90

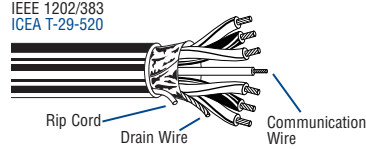

For Exposed Run rated cable, order 3002AE

Individually Shielded + Overall Beldfoil Shield (100% Coverage) • PVC Insulation • PVC Jacket (Black or Chrome)															
NEC: PLTC, ITC, CMG CEC: CMG FT4 IEEE 1202/383 ICEA T-29-520	3003A	2	E1	Bulk ^{††}	Bulk	—	—	.043	1.09	.330	8.38	82	364	3.25	82.55

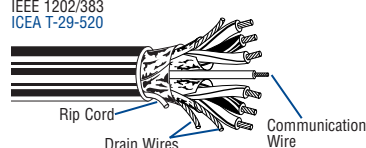

For Exposed Run rated cable, order 3003AE

*For tinned copper conductors, order with B suffix. E1, E2 = Refer to Technical Information section for color code. Alternate color coding available upon request.
[†]For Exposed Run rated 3000 series cables, order with "E" suffix, e.g. 3001AE.
^{††}Bulk = Check length available for specific construction.
 Multiple pair or triad cables have each pair/triad numbered for ease of identification.

UL Instrumentation Cable

300V Power-Limited Tray Cables

Industrial Grade Sunlight- and Oil-Resistant Jackets

Description	Part No.	No. of Pairs	Color Code	Standard Lengths		Standard Unit Weight		Jacket Thickness		Nominal OD		Maximum Pull Tension		Minimum Bend Radius	
				Ft.	m	Lbs.	kg	Inch	mm	Inch	mm	Lbs.	N	Inch	mm

20 AWG Pairs Stranded (19x32) Tinned Copper Conductors • Twisted Pairs

Unshielded • PVC Insulation • Chrome PVC Jacket

NEC: PLTC, ITC, CMG CEC: CMG FT4 IEEE 1202/383 ICEA T-29-520	9408	1	E2	U-500 U-1000	304.8 U-304.8	12.0 23.0	5.5 10.4	.037	.94	.214	5.44	31	138	2.00	50.80
---	-------------	---	----	-----------------	------------------	--------------	-------------	------	-----	------	------	----	-----	------	-------



Overall Beldfoil® Shield (100% Coverage) • PVC Insulation • Chrome PVC Jacket

NEC: PLTC, ITC, CMG CEC: CMG FT4 IEEE 1202/383 ICEA T-29-520	9320	1	E2	U-500 U-1000	304.8 U-304.8	14.5 28.0	6.6 12.7	.037	.94	.217	5.51	40	178	2.00	50.80
---	-------------	---	----	-----------------	------------------	--------------	-------------	------	-----	------	------	----	-----	------	-------

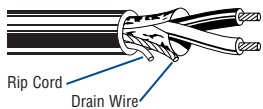

20 AWG Pairs Stranded (7x28) Bare Copper Conductors • Twisted Pairs

Overall Beldfoil Shield (100% Coverage) • PVC Insulation • Black PVC Jacket (See chart below for other options)

NEC: PLTC, ITC, CMG CEC: CMG FT4 IEEE 1202/383 ICEA T-29-520	1033A	1	E1	1000 10000 †	304.8 3048.0	30.0 270.0	13.6 122.5	.037	.94	.213	5.41	42	187	2.25	57.15
	3016A	2	E1	Bulk ††	Bulk	—	—	.042	1.07	.332	8.43	92	409	3.75	95.25
	1056A	4	E1	10000 †	3048.0	820.0	372.0	.053	1.35	.408	10.36	135	601	4.25	107.95
	1057A	8	E1	10000 †	3048.0	1410.0	640.2	.053	1.35	.472	11.99	247	1099	5.00	127.00
	1058A	12	E1	7500 †	2286.0	1455.0	660.0	.053	1.35	.564	14.33	359	1597	6.00	152.40
	1059A	16	E1	5000 †	1524.0	1275.0	578.9	.064	1.63	.649	16.48	232	1032	6.50	165.10
	1060A	24	E1	5000 †	1524.0	1735.0	787.7	.064	1.63	.786	19.96	695	3092	8.25	209.55
	1061A	36	E1	2500 †	762.0	1300.0	590.2	.074	1.88	.960	24.38	1031	4587	10.00	254.00
	1062A	50	E1	2500 †	762.0	1825.0	827.8	.074	1.88	1.117	28.37	1423	6330	11.50	292.10

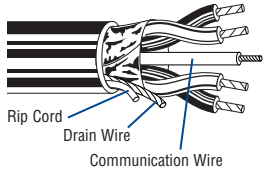

Individually Shielded + Overall Beldfoil Shield (100% Coverage) • PVC Insulation • Black PVC Jacket (Other options below)

NEC: PLTC, ITC, CMG CEC: CMG FT4 IEEE 1202/383 ICEA T-29-520	1075A	2	E1	10000 †	3048.0	650.0	294.8	.042	1.07	.337	8.56	97	432	3.75	95.25
	1076A	4	E1	7500 †	2286.0	787.5	357.5	.053	1.35	.411	10.44	171	761	4.50	114.30
	1077A	8	E1	7500 †	2286.0	1297.5	588.6	.053	1.35	.514	13.06	320	1424	5.50	139.70
	1078A	12	E1	7500 †	2286.0	1942.5	881.1	.064	1.63	.637	16.18	468	2082	6.75	171.45
	1079A	16	E1	5000 †	1524.0	1555.0	705.4	.064	1.63	.704	17.88	617	2745	7.50	190.50
	1091A	20	E1	Bulk ††	Bulk	—	—	.064	1.63	.780	19.81	765	3403	8.25	209.55
	1080A	24	E1	2500 †	762.0	1142.5	518.2	.074	1.88	.863	21.92	914	4066	9.00	228.60
	1081A	36	E1	2000 †	609.6	1436.0	651.9	.074	1.88	1.035	26.29	1359	6046	10.50	266.70
	1082A	50	E1	2000 †	609.6	1858.0	843.5	.074	1.88	1.215	30.86	1878	8355	12.75	323.85

F-R = Flame-retardant
 †Final put-up length may vary ±10% from length shown.
 ††Bulk = Check length available for specific construction.

E1, E2 = Refer to Technical Information section for color code.
 Alternate color coding available upon request.
 Multiple pair or triad cables have each pair/triad numbered for ease of identification.

Conductor, Insulation and Jacket Options**

To Specify:			Bare	Tinned	Insulation/Jacket
1234	A	E	A	B	PVC/PVC
Start with Part No.	Add or replace letter code for desired conductor, insulation & jacket	Add for Exposed Run rating if desired	C	D	XLPE/PVC
			K	L	TPE/TPE
			Q	R	XLPE/CPE
			S	T	XLPE/Haloarrest®

**For 1000 and 3000 Series cables only.



UL Instrumentation Cable

300V Power-Limited Tray Cables

Industrial Grade Sunlight- and Oil-Resistant Jackets

Description	Part No.	No. of Triads	Color Code	Standard Lengths		Standard Unit Weight		Jacket Thickness		Nominal OD		Maximum Pull Tension		Minimum Bend Radius	
				Ft.	m	Lbs.	kg	Inch	mm	Inch	mm	Lbs.	N	Inch	mm

20 AWG Triads Stranded (19x32) Tinned Copper Conductors • Twisted Triads

Unshielded • PVC Insulation • Chrome PVC Jacket

NEC: PLTC, ITC, CMG CEC: CMG FT4 IEEE 1202/383 ICEA T-29-520	9492	1	E1	U-500 U-1000	U-152.4 U-304.8	15.5 29.0	7.0 13.2	.037	.94	.225	5.72	46	205	2.25	57.15
---	-------------	---	----	-----------------	--------------------	--------------	-------------	------	-----	------	------	----	-----	------	-------

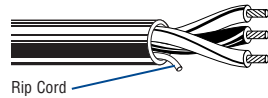

Overall Beldfoil® Shield (100% Coverage) • PVC Insulation • Chrome PVC Jacket

NEC: PLTC, ITC, CMG CEC: CMG FT4 IEEE 1202/383 ICEA T-29-520	9364	1	E1	U-500 U-1000	U-152.4 U-304.8	17.0 32.0	7.7 14.5	.037	.94	.228	5.79	46	205	2.25	57.15
---	-------------	---	----	-----------------	--------------------	--------------	-------------	------	-----	------	------	----	-----	------	-------

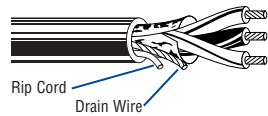

20 AWG Triads Stranded (7x28) Bare Copper Conductors • Twisted Triads

Overall Beldfoil Shield (100% Coverage) • PVC Insulation • Black PVC Jacket (See chart below for other options)

NEC: PLTC, ITC, CMG CEC: CMG FT4 IEEE 1202/383 ICEA T-29-520	1526A	1	E1	10000 [†]	3048.0	310.0	140.6	.037	.94	.215	5.46	42	187	2.20	55.88
	3017A	2	E1	Bulk ^{††}	Bulk	—	—	.055	1.40	.360	9.14	97	432	3.60	91.44
	3020A	4	E1	Bulk ^{††}	Bulk	—	—	.055	1.40	.470	11.94	174	774	4.75	120.65
	3021A	8	E1	Bulk ^{††}	Bulk	—	—	.055	1.40	.560	14.22	330	1468	5.00	127.00
	3022A	12	E1	Bulk ^{††}	Bulk	—	—	.066	1.68	.710	18.03	485	2158	7.00	177.80
	3023A	16	E1	Bulk ^{††}	Bulk	—	—	.064	1.63	.821	20.85	600	2669	7.75	196.85
	3024A	24	E1	Bulk ^{††}	Bulk	—	—	.074	1.88	1.031	26.19	920	4093	9.25	234.95

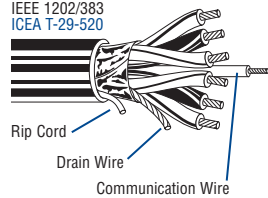

Individually Shielded + Overall Beldfoil Shield (100% Coverage) • PVC Insulation • Black PVC Jacket (Other options below)

NEC: PLTC, ITC, CMG CEC: CMG FT4 IEEE 1202/383 ICEA T-29-520	3018A	2	E1	Bulk ^{††}	Bulk	—	—	.055	1.40	.372	9.45	102	454	3.75	95.25
	1083A	4	E1	10000 [†]	3048.0	1410.8	640.9	.053	1.35	.451	11.46	228	1014	4.50	114.30
	1084A	8	E1	7500 [†]	2286.0	1755.0	796.1	.064	1.63	.575	10.81	432	1922	5.75	146.05
	1085A	12	E1	5000 [†]	1524.0	1735.0	787.0	.064	1.63	.714	18.14	636	2829	7.15	181.61
	1092A	16	E1	Bulk ^{††}	Bulk	—	—	.064	1.63	.793	20.14	841	3741	7.90	200.66
	1086A	24	E1	2500 [†]	762.0	1602.5	726.9	.074	1.88	.992	25.20	1250	5561	9.90	251.46
	3067A	36	E1	Bulk ^{††}	Bulk	—	—	.074	1.88	1.292	32.82	1875	6273	13.00	330.20

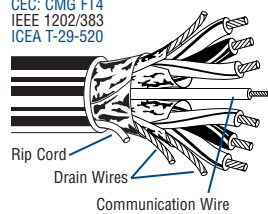

[†]Final put-up length may vary ±10% from length shown.
^{††}Bulk = Check length available for specific construction.

E1 = Refer to Technical Information section for color code.
Alternate color coding available upon request.

Multiple pair or triad cables have each pair/triad numbered for ease of identification.

Conductor, Insulation and Jacket Options**

To Specify:		
1234	A	E
Start with Part No.	Add or replace letter code for desired conductor, insulation & jacket	Add for Exposed Run rating if desired

Bare	Tinned	Insulation/Jacket
A	B	PVC/PVC
C	D	XLPE/PVC
K	L	TPE/TPE
Q	R	XLPE/CPE
S	T	XLPE/Haloarrest®

**For 1000 and 3000 Series cables only.



UL Instrumentation Cable

300V Power-Limited Tray Cables

Industrial Grade Sunlight- and Oil-Resistant Jackets

Description	Part No.	No. of Pairs	Color Code	Standard Lengths		Standard Unit Weight		Jacket Thickness		Nominal OD		Maximum Pull Tension		Minimum Bend Radius	
				Ft.	m	Lbs.	kg	Inch	mm	Inch	mm	Lbs.	N	Inch	mm

18 AWG Pairs Stranded (19x30) Tinned Copper Conductors • Twisted Pairs

Unshielded • PVC Insulation • Chrome PVC Jacket

NEC: PLTC, ITC, CMG CEC: CMG FT4 IEEE 1202/383 ICEA T-29-520	9409	1	E2	U-500 U-1000	U-152.4 U-304.8	15.0 28.0	6.8 12.7	.037	.94	.230	5.84	49	218	2.25	57.15
---	-------------	---	----	-----------------	--------------------	--------------	-------------	------	-----	------	------	----	-----	------	-------

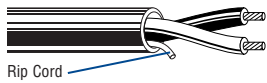

Overall Beldfoil® Shield (100% Coverage) • PVC Insulation • Chrome PVC Jacket

NEC: PLTC, ITC, CMG CEC: CMG FT4 IEEE 1202/383 ICEA T-29-520	9318	1	E2	U-500 U-1000	U-152.4 U-304.8	17.5 33.0	7.9 15.0	.037	.94	.233	5.92	60	267	2.25	57.15
	9552	2	E2	500 1000	152.4 304.8	35.5 69.0	16.1 31.4	.042	1.07	.368	9.34	65	289	3.70	93.98
	9553	3	E2	500 1000	152.4 304.8	49.5 98.0	22.0 49.4	.053	1.35	.411	10.44	145	645	4.10	104.14
	9554	4	E2	500 1000	152.4 304.8	57.0 112.0	25.8 50.8	.053	1.35	.447	11.35	187	832	4.50	114.30
	9556	6	E2	500 1000	152.4 304.8	78.5 153.0	35.7 69.5	.053	1.35	.497	12.62	270	1201	5.00	127.00
	9559	9	E2	500 1000	152.4 304.8	108.0 215.0	49.0 97.6	.053	1.35	.579	14.71	395	1757	5.80	147.32
	9563	11	E2	500 1000	152.4 304.8	133.0 270.0	60.4 122.5	.063	1.60	.665	16.89	478	2126	6.75	171.45
	9565	15	E2	500 1000	152.4 304.8	169.0 342.0	76.8 155.5	.063	1.60	.739	18.77	640	2847	7.50	190.50

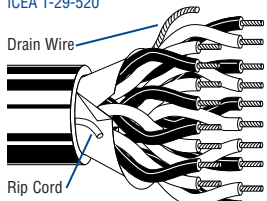

Individually Shielded (100% Coverage) • PVC Insulation • Chrome PVC Jacket

NEC: PLTC, ITC, CMG CEC: CMG FT4 IEEE 1202/383 ICEA T-29-520	9368	2	E2	500 1000	152.4 304.8	37.5 73.0	17.0 33.2	.042	1.07	.378	9.60	125	556	3.75	95.25
	9369	3	E2	500 1000	152.4 304.8	55.0 109.0	25.0 49.5	.053	1.35	.423	10.74	220	979	4.25	107.95
	3029A	4	E1	Bulk †	Bulk	—	—	.053	1.35	.461	11.71	296	1317	4.50	114.30
	9388	4	E2	500 1000	152.4 304.8	71.5 135.0	32.5 61.4	.053	1.35	.461	11.71	296	1317	4.60	116.84
	9389	6	E2	500 1000	152.4 304.8	97.0 190.0	44.1 86.4	.053	1.35	.538	13.67	440	1957	5.25	133.35
	9390	9	E2	500 1000	152.4 304.8	137.5 270.0	63.0 123.6	.064	1.63	.652	16.56	666	2963	6.50	165.10
	9391	11	E2	500 1000	152.4 304.8	158.5 321.0	72.0 145.9	.064	1.63	.729	18.52	815	3626	7.25	184.15
	9392	15	E2	500 1000	152.4 304.8	209.0 428.0	95.0 194.5	.064	1.63	.808	20.52	1100	4893	8.00	203.20

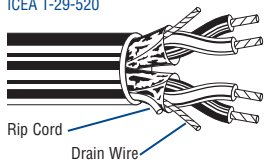

E1, E2 = Refer to Technical Information section for color code.
Alternate color coding available upon request.

Multiple pair or triad cables have each pair/triad numbered for ease of identification.

†Bulk = Check length available for specific construction.

Conductor, Insulation and Jacket Options**

To Specify:	Bare	Tinned	Insulation/Jacket
1234	A	B	PVC/PVC
5	C	D	XLPE/PVC
6	K	L	TPE/TPE
7	Q	R	XLPE/CPE
8	S	T	XLPE/Haloarrest®

**For 1000 and 3000 Series cables only.



UL Instrumentation Cable

300V Power-Limited Tray Cables

Industrial Grade Sunlight- and Oil-Resistant Jackets

Description	Part No.	No. of Pairs	Color Code	Standard Lengths		Standard Unit Weight		Jacket Thickness		Nominal OD		Maximum Pull Tension		Minimum Bend Radius	
				Ft.	m	Lbs.	kg	Inch	mm	Inch	mm	Lbs.	N	Inch	mm

18 AWG Pairs Stranded (7x26) Bare Copper Conductors • Twisted Pairs

Overall Beldfoil® Shield (100% Coverage) • PVC Insulation • Black PVC Jacket (See chart below for other options)

NEC: PLTC, ITC, CMG
CEC: CMG FT4
IEEE 1202/383
ICEA T-29-520

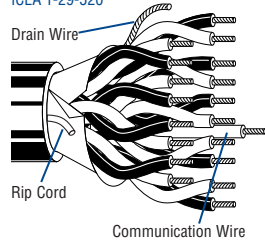

1032A	1	E1	1000 10000 †	304.8 3048.0	38.0 380.0	17.2 172.5	.037	.94	.233	5.92	67	298	2.50	63.50
3025A	2	E1	10000 †	3048.0	760.0	344.7	.042	1.07	.375	9.53	121	538	3.50	88.90
1529A	3	E1	7500 †	2286.0	735.0	333.4	.053	1.35	.415	10.54	165	734	4.25	107.95
1466A	4	E1	7500 †	2286.0	892.5	404.8	.053	1.35	.452	11.48	211	939	4.50	114.30
1467A	8	E1	7500 †	2286.0	1477.5	670.8	.053	1.35	.523	13.28	390	1735	5.50	139.70
1468A	12	E1	5000 †	1524.0	1375.0	624.3	.064	1.63	.673	17.09	560	2491	6.75	171.45
3034A	16	E1	Bulk ††	Bulk	—	—	.066	1.68	.713	18.11	640	2847	7.25	184.15
1471A	24	E1	2500 †	762.0	1292.5	586.3	.074	1.88	.932	23.67	1105	4916	9.25	234.95
1472A	36	E1	1250 †	381.0	910.0	413.1	.074	1.88	1.062	26.97	1644	7313	10.50	266.70
3041A	50	E1	Bulk ††	Bulk	—	—	.074	1.88	1.240	31.50	2240	10049	12.75	323.85

Individually Shielded + Overall Beldfoil (100% Coverage) • PVC Insulation • Black PVC Jacket (Other options below)

NEC: PLTC, ITC, CMG
CEC: CMG FT4
IEEE 1202/383
ICEA T-29-520

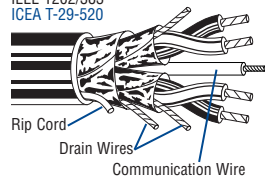

1474A	2	E1	7500 †	2286.0	720.0	326.9	.053	1.35	.408	10.16	149	663	4.00	101.60
1475A	4	E1	7500 †	2286.0	1065.0	483.1	.053	1.35	.468	11.89	267	1188	4.75	120.65
1476A	8	E1	5000 †	1524.0	1185.0	538.0	.053	1.35	.594	15.10	501	2229	6.00	152.40
1477A	12	E1	5000 †	1524.0	1740.0	789.3	.064	1.63	.737	18.72	779	3465	7.25	184.15
3035A	16	E1	Bulk ††	Bulk	—	—	.064	1.63	.836	21.20	725	3225	8.50	215.90
1480A	24	E1	2500 † 5000 †	762.0 1524.0	1712.5 3390.0	777.5 1539.1	.074	1.88	1.019	25.88	1443	6419	10.25	260.35
1481A	36	E1	Bulk ††	Bulk	—	—	.074	1.88	1.163	29.54	2148	9556	11.75	298.45
3042A	50	E1	Bulk ††	Bulk	—	—	.084	2.13	1.389	35.28	2935	13057	14.00	355.60

E1 = Refer to Technical Information section for color code.
Alternate color coding available upon request.

Multiple pair or triad cables have each pair/triad numbered for ease of identification.

†Final put-up length may vary ±10% from length shown.

††Bulk = Check length available for specific construction.

Conductor, Insulation and Jacket Options**

To Specify:		
1234	A	E
Start with Part No.	Add or replace letter code for desired conductor, insulation & jacket	Add for Exposed Run rating if desired

Bare	Tinned	Insulation/Jacket
A	B	PVC/PVC
C	D	XLPE/PVC
K	L	TPE/TPE
Q	R	XLPE/CPE
S	T	XLPE/Haloarrest®

**For 1000 and 3000 Series cables only.



For more information, contact Belden Technical Support: 1-800-BELDEN-1 • www.belden.com

UL Instrumentation Cable

300V Power-Limited Tray Cables

Industrial Grade Sunlight- and Oil-Resistant Jackets

Description	Part No.	No. of Triads	Color Code	Standard Lengths		Standard Unit Weight		Jacket Thickness		Nominal OD		Maximum Pull Tension		Minimum Bend Radius	
				Ft.	m	Lbs.	kg	Inch	mm	Inch	mm	Lbs.	N	Inch	mm

18 AWG Triads Stranded (19x30) Tinned Copper Conductors • Twisted Triads

Unshielded • PVC Insulation • Chrome PVC Jacket

NEC: PLTC, ITC, CMG CEC: CMG FT4 IEEE 1202/383 ICEA T-29-520	9493	1	E1	U-500 U-1000	U-152.4 U-304.8	20.0 38.0	9.1 17.2	.037	.94	.242	6.15	62	276	2.25	57.15
---	-------------	---	----	-----------------	--------------------	--------------	-------------	------	-----	------	------	----	-----	------	-------

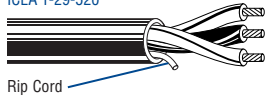

Overall Beldfoil® Shield (100% Coverage) • PVC Insulation • Chrome PVC Jacket

NEC: PLTC, ITC, CMG CEC: CMG FT4 IEEE 1202/383 ICEA T-29-520	9365	1	E1	U-500 U-1000	U-152.4 U-304.8	22.0 43.0	10.0 19.5	.037	.94	.245	6.22	74	329	2.50	63.50
---	-------------	---	----	-----------------	--------------------	--------------	--------------	------	-----	------	------	----	-----	------	-------

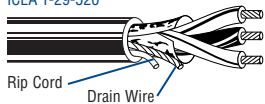

18 AWG Triads Stranded (7x26) Bare Copper Conductors • Twisted Triads

Overall Beldfoil Shield (100% Coverage) • PVC Insulation • Black PVC Jacket (See chart below for other options)

NEC: PLTC, ITC, CMG CEC: CMG FT4 IEEE 1202/383 ICEA T-29-520	1036A	1	E1	1000 10000 †	304.8 3048.0	43.0 430.0	19.5 195.1	.037	.94	.236	5.99	90	400	2.40	60.96
	3027A	2	E1	Bulk ††	Bulk	—	—	.055	1.40	.420	10.67	165	734	4.25	107.95
	3030A	4	E1	Bulk ††	Bulk	—	—	.055	1.40	.521	13.20	240	1068	4.50	114.30
	3032A	8	E1	Bulk ††	Bulk	—	—	.064	1.63	.580	14.70	501	2229	5.75	146.05
	3036A	16	E1	Bulk ††	Bulk	—	—	.077	1.96	.900	22.86	1050	4671	9.00	228.60
	3038A	24	E1	Bulk ††	Bulk	—	—	.077	1.96	1.020	25.91	1450	6450	10.25	260.35

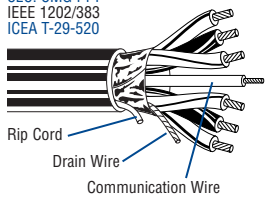

Individually Shielded + Overall Beldfoil (100% Coverage) • PVC Insulation • Black PVC Jacket (Other options below)

NEC: PLTC, ITC, CMG CEC: CMG FT4 IEEE 1202/383 ICEA T-29-520	3028A	2	E1	Bulk ††	Bulk	—	—	.055	1.40	.450	11.43	175	779	4.50	114.30
	3031A	4	E1	Bulk ††	Bulk	—	—	.053	1.35	.533	13.50	255	1134	5.25	133.35
	3033A	8	E1	Bulk ††	Bulk	—	—	.064	1.63	.654	16.50	560	2491	6.50	165.10
	3068A	12	E1	Bulk ††	Bulk	—	—	.063	1.60	.840	21.30	800	3559	8.50	215.90
	3037A	16	E1	Bulk ††	Bulk	—	—	.074	1.88	.974	24.70	1320	5872	10.50	266.70
	3039A	24	E1	Bulk ††	Bulk	—	—	.074	1.88	1.200	30.50	1620	7207	11.25	285.75

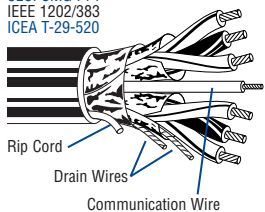

E1 = Refer to Technical Information section for color code.
Alternate color coding available upon request.

Multiple pair or triad cables have each pair/triad numbered for ease of identification.

†Final put-up length may vary ±10% from length shown.

††Bulk = Check length available for specific construction.

Conductor, Insulation and Jacket Options**

To Specify:	Bare	Tinned	Insulation/Jacket
1234	A	B	PVC/PVC
Start with Part No.	Add or replace letter code for desired conductor, insulation & jacket	Add for Exposed Run rating if desired	
	C	D	XLPE/PVC
	K	L	TPE/TPE
	Q	R	XLPE/CPE
	S	T	XLPE/Haloarrest®

**For 1000 and 3000 Series cables only.



UL Instrumentation Cable

300V Power-Limited Tray Cables

Industrial Grade Sunlight- and Oil-Resistant Jackets

Description	Part No.	No. of Pairs	Color Code	Standard Lengths		Standard Unit Weight		Jacket Thickness		Nominal OD		Maximum Pull Tension		Minimum Bend Radius	
				Ft.	m	Lbs.	kg	Inch	mm	Inch	mm	Lbs.	N	Inch	mm

16 AWG Pairs Stranded (19x29) Tinned Copper Conductors • Twisted Pairs

Unshielded • PVC Insulation • Chrome PVC Jacket

NEC: PLTC, ITC, CMG CEC: CMG FT4 IEEE 1202/383 ICEA T-29-520	9410	1	E2	U-500 U-1000	U-152.4 U-304.8	18.5 36.0	8.4 16.3	.037	.94	.254	6.45	78	347	2.50	63.50
---	-------------	---	----	-----------------	--------------------	--------------	-------------	------	-----	------	------	----	-----	------	-------

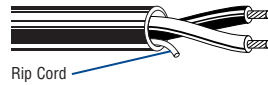

Overall Beldfoil® Shield (100% Coverage) • PVC Insulation • Chrome PVC Jacket

NEC: PLTC, ITC, CMG CEC: CMG FT4 IEEE 1202/383 ICEA T-29-520	9316	1	E2	U-500 U-1000	U-152.4 U-304.8	21.5 41.0	9.8 18.6	.037	.94	.256	6.50	90	400	2.50	63.50
---	-------------	---	----	-----------------	--------------------	--------------	-------------	------	-----	------	------	----	-----	------	-------

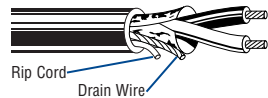

16 AWG Pairs Stranded (7x24) Bare Copper Conductors • Twisted Pairs

Unshielded • PVC Insulation • Black PVC Jacket (See chart below for other insulation and jacket options)

NEC: PLTC, ITC, CMG CEC: CMG FT4 IEEE 1202/383 ICEA T-29-520	1035A	1	E1	1000 10000 †	304.8 3048.0	40.0 400.0	18.1 181.4	.037	.94	.254	6.45	71	318	2.50	63.50
---	--------------	---	----	-----------------	-----------------	---------------	---------------	------	-----	------	------	----	-----	------	-------

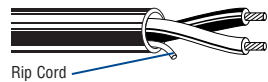

Overall Beldfoil Shield (100% Coverage) • PVC Insulation • Black PVC Jacket (See chart below for other options)

NEC: PLTC, ITC, CMG CEC: CMG FT4 IEEE 1202/383 ICEA T-29-520	1030A	1	E1	1000 10000 †	304.8 3048.0	46.0 480.0	20.9 217.7	.037	.94	.257	6.53	94	418	2.50	63.50
	3043A	2	E1	Bulk ††	Bulk	—	—	.053	1.35	.437	11.10	83	369	4.50	114.30
	1528A	3	E1	7500 †	2286.0	967.5	438.9	.053	1.35	.457	11.61	250	1112	4.75	120.65
	1484A	4	E1	7500 †	2286.0	1200.0	544.8	.053	1.35	.495	12.57	330	1468	5.00	127.00
	1485A	8	E1	7500 †	2286.0	2010.0	911.7	.053	1.35	.597	15.16	616	2740	6.00	152.40
	1486A	12	E1	5000 †	1524.0	1965.0	892.1	.064	1.63	.741	18.80	892	3968	7.50	190.50
	3050A	16	E1	Bulk ††	Bulk	—	—	.064	1.63	.831	21.10	661	2940	8.50	215.90
	1489A	24	E1	1250 †	381.0	923.8	419.4	.074	1.88	1.032	26.20	1749	7780	10.50	266.70
	1490A	36	E1	1250 †	381.0	1313.8	596.4	.074	1.88	1.178	29.80	2606	11592	11.75	298.45
	3056A	50	E1	Bulk ††	Bulk	—	—	.088	2.24	1.550	39.37	3615	16082	15.50	393.70

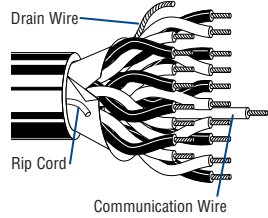

Individually Shielded + Overall Beldfoil Shield (100% Coverage) • PVC Insulation • Black PVC Jacket (Options below)

NEC: PLTC, ITC, CMG CEC: CMG FT4 IEEE 1202/383 ICEA T-29-520	1492A	2	E1	7500 †	2286.0	885.0	401.8	.053	1.35	.450	11.43	232	1032	4.50	114.30
	1493A	4	E1	7500 †	2286.0	1387.5	629.4	.055	1.40	.512	13.11	420	1868	5.00	127.00
	1494A	8	E1	5000 †	1524.0	1640.0	743.9	.066	1.68	.687	17.50	795	3537	7.00	177.80
	1495A	12	E1	2500 †	762.0	1202.5	545.5	.066	1.68	.822	20.73	1170	5205	8.25	209.55
	3051A	16	E1	Bulk ††	Bulk	—	—	.074	1.88	.936	23.77	661	2940	10.00	254.00
	1498A	24	E1	5000 †	1524.0	4340.0	1968.6	.074	1.88	1.149	29.18	2296	10214	11.50	292.10
	1499A	36	E1	Bulk ††	Bulk	—	—	.084	2.13	1.334	33.88	3167	14088	13.50	342.90
	3057A	50	E1	Bulk ††	Bulk	—	—	.088	2.24	1.600	40.64	2066	9190	16.00	406.40

E1, E2 = Refer to Technical Information section for color code.
Alternate color coding available upon request.

Multiple pair or triad cables have each pair/triad numbered for ease of identification.

†Final put-up length may vary ±10% from length shown.

††Bulk = Check length available for specific construction.

Conductor, Insulation and Jacket Options**

To Specify:		
1234	A	E
Start with Part No.	Add or replace letter code for desired conductor, insulation & jacket	Add for Exposed Run rating if desired

Bare	Tinned	Insulation/Jacket
A	B	PVC/PVC
C	D	XLPE/PVC
K	L	TPE/TPE
Q	R	XLPE/CPE
S	T	XLPE/Haloarrest®

**For 1000 and 3000 Series cables only.



For more information, contact Belden Technical Support: 1-800-BELDEN-1 • www.belden.com

UL Instrumentation Cable

300V Power-Limited Tray Cables

Industrial Grade Sunlight- and Oil-Resistant Jackets

Description	Part No.	No. of Triads	Color Code	Standard Lengths		Standard Unit Weight		Jacket Thickness		Nominal OD		Maximum Pull Tension		Minimum Bend Radius	
				Ft.	m	Lbs.	kg	Inch	mm	Inch	mm	Lbs.	N	Inch	mm

16 AWG Triads Stranded (19x29) Tinned Copper Conductors • Twisted Triads

Unshielded • PVC Insulation • Chrome PVC Jacket

NEC: PLTC, ITC, CMG CEC: CMG FT4 IEEE 1202/383 ICEA T-29-520	9494	1	E1	U-500 U-1000	U-152.4 U-304.8	24.5 48.0	11.1 21.8	.037	.94	.268	6.81	91	405	2.75	69.85
---	-------------	---	----	-----------------	--------------------	--------------	--------------	------	-----	------	------	----	-----	------	-------

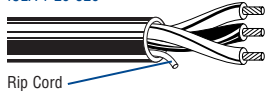

Overall Beldfoil® Shield (100% Coverage) • PVC Insulation • Chrome PVC Jacket

NEC: PLTC, ITC, CMG CEC: CMG FT4 IEEE 1202/383 ICEA T-29-520	9366	1	E1	U-500 U-1000	U-152.4 U-304.8	27.5 54.0	12.5 24.5	.037	.94	.270	6.86	116	516	2.75	69.85
---	-------------	---	----	-----------------	--------------------	--------------	--------------	------	-----	------	------	-----	-----	------	-------

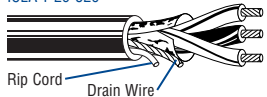

16 AWG Triads Stranded (7x24) Bare Copper Conductors • Twisted Triads

Unshielded • PVC Insulation • Black PVC Jacket (See chart below for other options)

NEC: PLTC, ITC, CMG CEC: CMG FT4 IEEE 1202/383 ICEA T-29-520	1034A	1	E1	1000 4000 †	304.8 1219.2	51.0 208.0	23.2 94.4	.037	.94	.268	6.81	107	476	2.75	69.85
---	--------------	---	----	----------------	-----------------	---------------	--------------	------	-----	------	------	-----	-----	------	-------

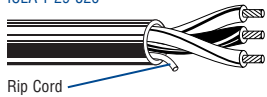

Overall Beldfoil Shield (100% Coverage) • PVC Insulation • Black PVC Jacket (See chart below for other options)

NEC: PLTC, ITC, CMG CEC: CMG FT4 IEEE 1202/383 ICEA T-29-520	1031A	1	E1	1000 10000 †	304.8 3048.0	58.0 610.0	26.4 276.7	.037	.94	.271	6.88	130	578	2.75	69.85
	3044A	2	E1	Bulk ††	Bulk	—	—	.053	1.35	.483	12.27	259	1152	4.75	120.65
	3046A	4	E1	Bulk ††	Bulk	—	—	.053	1.35	.570	14.40	473	2104	5.75	146.05
	3048A	8	E1	Bulk ††	Bulk	—	—	.063	1.60	.760	19.30	902	4013	7.50	190.50
	3052A	16	E1	Bulk ††	Bulk	—	—	.074	1.88	1.032	26.21	1758	7821	11.25	285.75
	3054A	24	E1	Bulk ††	Bulk	—	—	.074	1.88	1.180	29.90	2615	11633	11.75	298.45

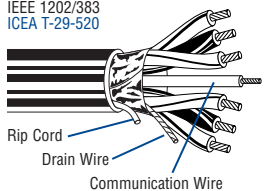

Individually Shielded + Overall Beldfoil Shield (100% Coverage) • PVC Insulation • Black PVC Jacket (Options below)

NEC: PLTC, ITC, CMG CEC: CMG FT4 IEEE 1202/383 ICEA T-29-520	3045A	2	E1	Bulk ††	Bulk	—	—	.053	1.35	.506	12.80	304	1352	5.00	127.00
	3047A	4	E1	Bulk ††	Bulk	—	—	.053	1.35	.569	14.45	563	2505	6.00	152.40
	3049A	8	E1	Bulk ††	Bulk	—	—	.064	1.63	.764	19.41	1081	4809	8.00	203.20
	3069A	12	E1	Bulk ††	Bulk	—	—	.074	1.88	.998	25.35	1500	6673	10.00	254.00
	3053A	16	E1	Bulk ††	Bulk	—	—	.074	1.88	1.150	29.20	2117	9418	11.50	292.10
	3055A	24	E1	Bulk ††	Bulk	—	—	.084	2.13	1.320	33.53	3153	14026	13.25	336.55

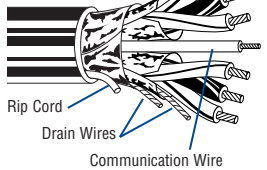

E1 = Refer to Technical Information section for color code.
Alternate color coding available upon request.

Multiple pair or triad cables have each pair/triad numbered for ease of identification.

†Final put-up length may vary ±10% from length shown.

††Bulk = Check length available for specific construction.

Conductor, Insulation and Jacket Options**

To Specify:	Bare	Tinned	Insulation/Jacket
1234	A	B	PVC/PVC
Start with Part No.	Add or replace letter code for desired conductor, insulation & jacket	Add for Exposed Run rating if desired	
	C	D	XLPE/PVC
	K	L	TPE/TPE
	Q	R	XLPE/CPE
	S	T	XLPE/Haloarrest®

**For 1000 and 3000 Series cables only.



UL Instrumentation Cable

300V Power-Limited Tray Cables

Industrial Grade Sunlight- and Oil-Resistant Jackets

Description	Part No.	No. of Pairs/Triads	Color Code	Standard Lengths		Standard Unit Weight		Jacket Thickness		Nominal OD		Maximum Pull Tension		Minimum Bend Radius	
				Ft.	m	Lbs.	kg	Inch	mm	Inch	mm	Lbs.	N	Inch	mm

14 AWG Pairs Stranded (42x30) Tinned Copper Conductors • Twisted Pairs

Unshielded • PVC Insulation • Chrome PVC Jacket

NEC: PLTC, ITC, CL3R CEC: FT4 IEEE 1202/383 ICEA T-29-520	9411	1	E2	U-500 1000	U-152.4 304.8	28.0 60.0	12.7 27.3	.042	1.07	.322	8.18	124	552	3.25	82.55
--	-------------	---	----	---------------	------------------	--------------	--------------	------	------	------	------	-----	-----	------	-------

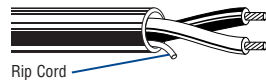

Overall Beldfoil® Shield (100% Coverage) • PVC Insulation • Chrome PVC Jacket

NEC: PLTC, ITC, CL3R CEC: FT4 IEEE 1202/383 ICEA T-29-520	9314	1	E2	U-500 1000	U-152.4 304.8	32.5 66.0	14.7 29.9	.042	1.07	.324	8.23	140	623	3.25	82.55
--	-------------	---	----	---------------	------------------	--------------	--------------	------	------	------	------	-----	-----	------	-------

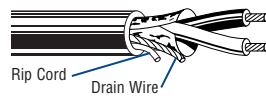

14 AWG Triads Stranded (42x30) Tinned Copper Conductors • Twisted Triads

Unshielded • PVC Insulation • Chrome PVC Jacket

NEC: PLTC, ITC, CL3R CEC: FT4 IEEE 1202/383 ICEA T-29-520	9495	1	E1	500 1000	152.4 304.8	43.5 86.0	19.7 39.0	.042	1.07	.340	8.64	186	827	3.50	88.90
--	-------------	---	----	-------------	----------------	--------------	--------------	------	------	------	------	-----	-----	------	-------

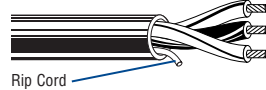

Overall Beldfoil Shield (100% Coverage) • PVC Insulation • Chrome PVC Jacket

NEC: PLTC, ITC, CL3R CEC: FT4 IEEE 1202/383 ICEA T-29-520	9367	1	E1	500 1000	152.4 304.8	43.5 88.0	19.7 40.0	.042	1.07	.343	8.71	188	836	3.50	88.90
--	-------------	---	----	-------------	----------------	--------------	--------------	------	------	------	------	-----	-----	------	-------

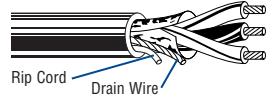

E1, E2 = Refer to Technical Information section for color code.
Alternate color coding available upon request.

UL Instrumentation Cable

300V Power-Limited Tray Cables

Industrial Grade Sunlight- and Oil-Resistant Jackets

Description	Part No.	No. of Pairs/Triads	Color Code	Standard Lengths		Standard Unit Weight		Jacket Thickness		Nominal OD		Maximum Pull Tension		Minimum Bend Radius	
				Ft.	m	Lbs.	kg	Inch	mm	Inch	mm	Lbs.	N	Inch	mm

12 AWG Pairs Stranded (65x30) Tinned Copper Conductors • Twisted Pairs

Unshielded • PVC Insulation • Chrome PVC Jacket

NEC: ITC, CL3R CEC: FT4 IEEE 1202/383 ICEA T-29-520	9412	1	E2	500	152.4	41.5	18.8	.042	1.07	.370	9.40	197	876	4.25	107.95
				1000	304.8	83.0	37.7								

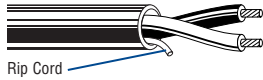

Overall Beldfoil® Shield (100% Coverage) • PVC Insulation • Chrome PVC Jacket

NEC: PLTC, ITC, CL3R CEC: FT4 IEEE 1202/383 ICEA T-29-520	9312	1	E2	500	152.4	49.0	22.3	.042	1.07	.373	9.47	225	1001	4.25	107.95
				1000	304.8	96.0	43.6								

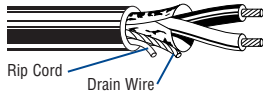

12 AWG Triads Stranded (7x20) Bare Copper Conductors • Twisted Triads

Overall Beldfoil® Shield (100% Coverage) • PVC Insulation • Black PVC Jacket (See chart below for other options)

NEC: PLTC, ITC, CL3R CEC: FT4 IEEE 1202/383 ICEA T-29-520	3102A	1	E1	Bulk †	Bulk	—	—	.053	1.35	.432	11.00	315	1401	3.50	88.90
--	--------------	---	----	--------	------	---	---	------	------	------	-------	-----	------	------	-------

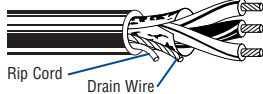

E1, E2 = Refer to Technical Information section for color code.
Alternate color coding available upon request.

†Bulk = Check length available for specific construction.

Conductor, Insulation and Jacket Options**

To Specify:			Bare	Tinned	Insulation/Jacket
1234	A	E	A	B	PVC/PVC
Start with Part No.	Add or replace letter code for desired conductor, insulation & jacket	Add for Exposed Run rating if desired	C	D	XLPE/PVC
			K	L	TPE/TPE
			Q	R	XLPE/CPE
			S	T	XLPE/Haloarrest®

**For 1000 and 3000 Series cables only.



For more information, contact Belden Technical Support: 1-800-BELDEN-1 • www.belden.com

UL Instrumentation Cable

Thermocouple Extension Cables and Thermocouple Wire — Overview

Construction Thermocouple Extension Cable

Conductor material determined by the thermocouple extension wire type. FEP or PVC insulated with FEP or PVC jacket. Nylon rip cord included in all PVC-jacketed thermocouple extension cables. Communication wire included on all multi-pair, PVC constructions — 22 AWG (7x30) bare copper orange PVC insulation.

NOTE: The temperature ranges in Table A are applicable only to the thermocouple conductors and not to the cable. The cable must never be exposed to temperatures higher than the maximum temperature ratings shown in Table B.

Table B: Other Insulation/Jacket Options

UL Listed for PLTC	
Insulation/Jacket	Max. Temp Rating
XLPE/PVC	90°C
XLPE/CPE	90°C
PVC/PVC	105°C
PVC/CPE	105°C
PE/PVC	75°C
FPE/PVC	75°C
TPE/TPE	105°C
XLPE/Haloarrest®	90°C
FEP/FEP	200°C

Application

Unshielded

Parallel non-shielded extension wire may be utilized in low noise environments when recommended by the instrument manufacturer.

Overall Shield

Recommended, except in areas where high voltage and current sources create excessive noise interference. The Beldfoil® shield with drain wire provides 100% coverage for maximum shield effectiveness.

Individually Shielded

Individually shielded pairs are recommended for use in applications where optimum noise rejection is required.

PVC Insulated, PVC Jacketed Cable Specifications

- UL Subject 13
- UL 1685 (UL 1581) Vertical Tray Flame Test comparable to IEEE 383-1974 (70,000 BTU) Flame Test
- ANSI/MC 96.1-1982
- NEC CMG
- NEC Type PLTC Listed, which is approved for cable tray use in Class 1, Division 2, hazardous areas and non-hazardous areas, cable trays, raceways, conduit and supported by messenger wires.

- NEC Type ITC Listed, which is approved for cable tray use, raceways hazardous locations according to Articles 501, 502, 503 and 504; or as aerial on a cable messenger, and under raised floors in control rooms and rack rooms where arranged to prevent damage to the cable. Usages are allowed based on qualified persons servicing all installations.
- PVC/PVC constructions are CMG, FT4, IEEE 1202 and IEEE 383-2003 rated, and meet ICEA T-29-520 Flame Test.
- UL 1277 TC versions approved for use in Class 1 trays available as special.

Shielded Twisted Pair (FEP insulated, FEP jacketed cable specifications)

- UL Subject 13
- NFPA 262 (UL 910 Steiner Tunnel Flame Test) comparable to FT6 Flame Test
- ANSI/MC 96.1-1982
- NEC Type CL3P/PLTC Listed, which is approved for use in ducts, plenums and other space used for environmental air.
- UL 1277 TC versions approved for use in Class 1 trays available as special.

Thermocouple Wire

Conductor material determined by the thermocouple type. FEP insulated and jacketed flat constructions.

FEP thermocouple wire is impervious to chemical attack and is flame retardant.

Table A: Thermocouple Identification and Limits of Error — Reference Junction 0°C*

ANSI Symbol	Temperature Range (°C) (conductor only)	Limits of Error Standard (°C)	Jacket Color	Insulation Color Code		Conductor Identification	
				Positive (+)	Negative (-)	Positive (+)	Negative (-)
E	0 to 340 340 to 540	±1.7°C ±.50%	Brown	Purple	Red	Chromel® Non-magnetic	Constantan Silver Color
J	0 to 293 293 to 480	±2.2°C ±.75%	Brown	White	Red	Iron Magnetic	Constantan Non-magnetic
K	0 to 293 293 to 980	±2.2°C ±.75%	Brown	Yellow	Red	Chromel Non-magnetic	Alumel® Magnetic
T	0 to 133 133 to 260	±1.0°C ±.75%	Brown	Blue	Red	Copper Copper Color	Constantan Non-magnetic
EX	0 to 200	±1.7°C	Purple	Purple	Red	Chromel	Constantan
JX	0 to 200	±2.2°C	Black	White	Red	Iron	Constantan
KX	0 to 200	±2.2°C	Yellow	Yellow	Red	Chromel	Alumel
TX	0 to 100	±1.0°C	Blue	Blue	Red	Copper	Constantan

Limits of error per ANSI MC96.1-1982. Limits shown do not include system or installation error. Percentages refer to the temperature being measured.

*The Temperature Range and Limits of Error are for standard grade thermocouples, Reference ANSI MC96.1-1982 for special grade thermocouples. The Temperature Ranges for type E, J, K and T thermocouple wires listed above pertain to 20 AWG wire.

Additional constructions available upon request.

Standard lengths may be subject to tolerance. Custom lengths may be available upon request. Contact the Belden Electronics Division Customer Service Department for additional information. 1-800-BELDEN-1



UL Instrumentation Cable

Thermocouple Extension Cables

Industrial Grade Sunlight- and Oil-Resistant Jackets

Description	Part No.	ANSI Type	No. of Pairs	Color Code	Jacket Color	Standard Lengths		Standard Unit Weight		Insulation Thickness		Nominal OD	
						Ft.	m	Lbs.	kg	Inch	mm	Inch	mm

20 AWG Pairs Solid Conductors • (See chart on page 18.53 for conductor specifications by ANSI Type)

Overall Beldfoil® Shield (100% Coverage) • PVC Insulation • PVC Jacket

300V 105°C NEC: PLTC, ITC, CMG CEC: CMG FT4 ICEA T-29-520 IEEE 1202/383	3111A	JX	1	White, Red	Black	5000 †	1524.0	115.0	52.2	.016	.41	.206	5.23
	3112A	KX	1	Yellow, Red	Yellow	5000 †	1524.0	120.0	54.5	.016	.41	.206	5.23
	3113A	TX	1	Blue, Red	Blue	5000 †	1524.0	115.0	52.2	.016	.41	.206	5.23

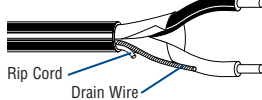

Individually Shielded + Overall Beldfoil Shield (100% Coverage) • PVC Insulation • PVC Jacket

300V 105°C NEC: PLTC, ITC, CMG CEC: CMG FT4 ICEA T-29-520 IEEE 1202/383	3115A	JX	2	White, Red	Black	5000 †	1524.0	315.0	143.0	.016	.41	.332	8.43
	1006A	JX	4	White, Red	Black	5000 †	1524.0	480.0	217.9	.016	.41	.383	9.73
	1012A	KX	4	Yellow, Red	Yellow	5000 †	1524.0	530.0	240.6	.016	.41	.383	9.73
	1013A	KX	8	Yellow, Red	Yellow	5000 †	1524.0	825.0	374.6	.016	.41	.503	12.78
	1014A	KX	12	Yellow, Red	Yellow	5000 †	1524.0	1195.0	542.5	.016	.41	.603	15.32

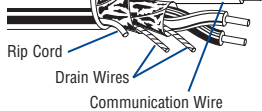

16 AWG Pairs Solid Conductors • (See chart on page 18.53 for conductor specifications by ANSI Type)

Overall Beldfoil Shield (100% Coverage) • PVC Insulation • PVC Jacket

300V 105°C NEC: PLTC, ITC, CMG CEC: CMG FT4 ICEA T-29-520 IEEE 1202/383	1101A	EX	1	Purple, Red	Purple	10000 †	3048.0	450.0	204.3	.017	.43	.248	6.30
	1000A	JX	1	White, Red	Black	1000	304.8	42.0	19.1	.017	.43	.248	6.30
						10000 †	3048.0	420.0	190.7				
	1018A	KX	1	Yellow, Red	Yellow	1000	304.8	42.0	19.1	.017	.43	.248	6.30
						10000 †	3048.0	420.0	190.7				
	1023A	TX	1	Blue, Red	Blue	10000 †	3048.0	450.0	204.3	.017	.43	.248	6.30



Multiple pair cables have each pair numbered for ease of identification.

†Final put-up length may vary ±10% from length shown.

UL Instrumentation Cable

High-Temperature Thermocouple Extension Cables and Thermocouple Wire
Industrial Grade Sunlight- and Oil-Resistant Jackets

Description	Part No.	ANSI Type	No. of Pairs/Cond.	Color Code	Jacket Color	Standard Lengths		Standard Unit Weight		Insulation Thickness		Nominal OD	
						Ft.	m	Lbs.	kg	Inch	mm	Inch	mm

High-Temp Extension Cable • 20 AWG Solid Conductors • (See chart on page 18.53 for conductor specifications by ANSI Type)

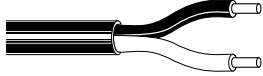
Plenum • Unshielded • FEP Insulation • FEP Jacket													
300V 200°C NEC: PLTC, CL3P 	83932	KX	2/c	Yellow, Red	Yellow	500 †	152.4	6.5	3.0	.010	.25	.076	1.93
						1000 †	304.8	12.0	5.4			x	x
	83934	TX	2/c	Blue, Red	Blue	1000 †	304.8	13.0	6.0	.010	.25	.076	1.93
												x	x
												.128	3.25

High-Temp Extension Cable • 20 AWG Stranded (7x28) Conductors • (See chart on page 18.53 for conductor specifications by ANSI Type)

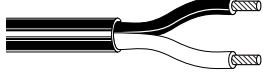
Plenum • Unshielded • FEP Insulation • FEP Jacket													
300V 200°C NEC: PLTC, CL3P 	83930	JX	2/c	White, Red	Black	500 †	152.4	7.5	3.4	.010	.25	.082	2.08
						1000 †	304.8	13.0	6.0			x	x
												.140	3.56

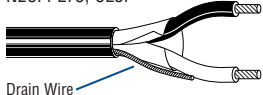
Plenum • Overall Beldfoil® Shield (100% Coverage) • FEP Insulation • FEP Jacket													
300V 200°C NEC: PLTC, CL3P 	83955	EX	1 pr.	Purple, Red	Purple	500 †	152.4	9.0	4.1	.010	.25	.145	3.68
						1000 †	304.8	16.0	7.3				
	83950	JX	1 pr.	White, Red	Black	500 †	152.4	9.5	4.3	.010	.25	.145	3.68
						1000 †	304.8	16.0	7.3				
	83952	KX	1 pr.	Yellow, Red	Yellow	500 †	152.4	9.5	4.3	.010	.25	.145	3.68
						1000 †	304.8	16.0	7.3				
	83954	TX	1 pr.	Blue, Red	Blue	500 †	152.4	9.0	4.1	.010	.25	.145	3.68
						1000 †	304.8	17.0	7.7				

High-Temp Extension Cable • 16 AWG Pairs Solid Conductors • (See chart on page 18.53 for conductor specifications by ANSI Type)

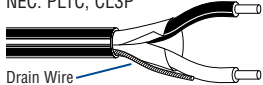
Plenum • Overall Beldfoil Shield (100% Coverage) • FEP Insulation • FEP Jacket													
300V 200°C NEC: PLTC, CL3P 	1114A	EX	1	Purple, Red	Purple	5000 †	1524.0	160.0	72.6	.010	.25	.172	4.37
						1115A	JX	1	White, Red	Black	5000 †	1524.0	155.0
	1116A	KX	1	Yellow, Red	Yellow	5000 †	1524.0	160.0	72.6	.010	.25	.171	4.34
	1117A	TX	1	Blue, Red	Blue	5000 †	1524.0	160.0	72.6	.010	.25	.172	4.37

High-Temp Extension Cable • 16 AWG Pairs Stranded (7x24) Conductors • (See chart on page 18.53 for conductor specifications by ANSI Type)

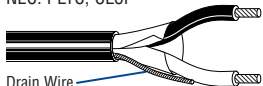
Plenum • Overall Beldfoil Shield (100% Coverage) • FEP Insulation • FEP Jacket													
300V 200°C NEC: PLTC, CL3P 	83951	JX	1	White, Red	Black	500 †	152.4	16.0	7.3	.010	.25	.189	4.80
						1000 †	304.8	35.0	15.9				
	83953	KX	1	Yellow, Red	Yellow	500 †	152.4	16.0	7.3	.010	.25	.187	4.75
						1000 †	304.8	32.0	14.5				

High-Temp Thermocouple Wire • 20 AWG Solid Conductors • (See chart on page 18.53 for conductor specifications by ANSI Type)

Plenum • Unshielded • FEP Insulation • FEP Jacket													
300V 200°C NEC: PLTC, CL3P 	83915	E	2/c	Purple, Red	Brown	500 †	152.4	7.0	3.2	.010	.25	.076	1.93
						1000 †	304.8	13.0	6.0			x	x
	83900	J	2/c	White, Red	Brown	100	30.5	2.1	1.0	.010	.25	.076	1.93
						500 †	152.4	7.0	3.2			x	x
						1000 †	304.8	13.0	6.0			.128	3.25
	83905	K	2/c	Yellow, Red	Brown	100	30.5	2.1	1.0	.010	.25	.076	1.93
						500 †	152.4	7.0	3.2			x	x
						1000 †	304.8	12.0	5.4			.128	3.25
	83910	T	2/c	Blue, Red	Brown	100	30.5	2.1	1.0	.010	.25	.076	1.93
						500 †	152.4	7.0	3.2			x	x
						1000 †	304.8	12.0	5.4			.128	3.25

FEP = Fluorinated Ethylene-propylene

Multiple pair cables have each pair numbered for ease of identification.

†Final put-up length may vary ±10% from length shown.

UL Instrumentation Cable

600V Tray Cables – Overview

Tray Cable Construction Options

UL Listed for MC and TC				
Insulation/Jacket	Max. Temp Rating		Flame Tests	Ratings*
	Wet	Dry		
PVC-Nylon/PVC (THHN or THWN) 14 AWG & larger	75°C	90°C	UL 1685 FT4/IEEE 1202/383 ICEA T-29-520	ICEA S-73-532 ICEA S-61-402
PVC-Nylon/PVC (TFN or TFFN) 16 & 18 AWG	N/A	90°C	UL 1685 FT4/IEEE 1202/383 ICEA T-29-520	ICEA S-73-532 ICEA S-61-402
XLPE/PVC or CPE (XHHW-2) 14 AWG & larger	90°C	90°C	UL 1685 FT4/IEEE 1202/383 VW-1 rated singles ICEA T-29-520	ICEA S-73-532 ICEA S-66-524
XLPE/PVC or CPE (RFH-2) 16 & 18 AWG	75°C	75°C	UL 1685 FT4/IEEE 1202/383 VW-1 rated singles ICEA T-29-520	ICEA S-73-532 ICEA S-66-524 ICEA S-82-552
FRPO/PVC 18 AWG & larger	—	75°C	UL 1685	
TPE/TPE	75°C	90°C	UL 1685	
FRPO/PVC	75°C	90°C	UL 1685	
XLPE/Haloarrest® (XHHW-2) 14 AWG & larger	90°C	90°C	UL 1685 ICEA T-29-520 FT4/IEEE 1202/383	TC-LS
XLPE/Haloarrest (RFH-2) 16 & 18 AWG	75°C	75°C	UL 1685 ICEA T-29-520 FT4/IEEE 1202/383	TC-LS
FEP/PVC	90°C	90°C	UL 1685	

CPE = Chlorinated Polyethylene • FEP = Fluorinated Ethylene-propylene • FRPO = Flame-retardant Polyolefin • PVC = Polyvinyl Chloride • TPE = Thermoplastic Elastomer • XLPE = Cross-linked Polyethylene

*Applicable to TC-rated cables only.

Construction

Soft annealed bare or tinned copper conductors. PVC insulated with a nylon overcoat, 90°C PVC Jacket, TFN, TFFN or THHN style singles. Nylon rip cord included in all PVC-Nylon/PVC instrumentation cables.

Application

These cables are suitable for installation in wet or dry locations. Cable jackets are resistant to sunlight, moisture and vapor penetration. The cables can be used in raceways, and (supported by messenger wire), outdoor applications and direct burial applications.

Unshielded

Twisted non-shielded instrument pairs provide a minimal OD allowing greater tray and conduit fill. Non-shielded instrument pairs may be utilized when recommended by the instrument manufacturer and used in a metallic conduit.

Overall Shield

Recommended for use in instrumentation applications where signals are transmitted in excess of 100 millivolts except in areas where high voltage and current sources creates excessive noise interference.

The Beldfoil® shield with drain wire provides 100% coverage for maximum shield effectiveness. Copper tape shield available upon request.

Individually Shielded and Overall Shielded

Individually shielded pairs or triads with an overall shield are recommended for use in instrumentation applications where optimum noise rejection is required. Individual pair/triad shields are fully isolated from each other and contain a separate drain wire for grounding, to provide maximum protection from crosstalk and common mode interference. Cables with an overall shield provide additional electrostatic noise protection.

Conductor, Insulation and Jacket Options*

To Specify:	Bare	Tinned	Insulation/Jacket
A	B		PVC-Nylon/PVC
C	D		XLPE/PVC
E	F		FRPO/PVC
G	H		XLPE/TPE
K	L		TPE/TPE
M	N		PVC-Nylon/Oil Res II
Q	R		XLPE/CPE
S	T		XLPE/Haloarrest

*For 1000 and 3000 Series cables only.

To Specify:

1234 A

Start with Part No. 1234
Add or replace letter code A

Specifications

- UL Subject 1277 TC
- UL 1685 (UL 1581) Vertical Tray Flame Test comparable to IEEE 383-1974 (70,000 BTU/hr.) Flame Test
- NEC Type TC Listed, which is approved for cable tray use in Class 1, Division 2 areas, per NEC Articles 340, 318 and 501 and for Class 1 circuits as permitted in Article 725
- PVC-nylon/PVC constructions are NEC Type NPLF Listed, which is approved for use in Non Power-Limited Fire Protective Signaling circuits, per NEC Article 760
- PVC-Nylon/PVC, XLPE/PVC and XLPE/CPE constructed cables meet IEEE 1202/IEEE 383-2003/FT4 (70,000 BTU) Flame Test
- XLPE/Haloarrest cables are UL 1277 TC-LS rated

TC-ER Rated Cables

As an option, Belden offers all PVC-nylon/PVC, XLPE/PVC and XLPE/CPE jacketed tray cables with a TC-ER (Exposed Run) rating, formerly referred to as Open Wiring.

Per NEC Article 336, a TC-ER rated cable may be installed in an industrial establishment between a cable tray and the utilization equipment or device. A TC-ER rated cable must meet the crush and impact requirements of UL Type MC cable. By eliminating the need for metal conduit and/or armor, using a TC-ER rated cable results in savings in both installation and maintenance.

MC Cable Ratings Optional

Customize any 600V TC instrumentation cable, with armor and a full-sized ground. See chart below to specify.

To Specify MC Rated Cable

1	2	3456	A
Overall Jacket Type	Armor Type	Core 4-digit Part No. 600V TC Instrumentation	Conductor, Insulation, Inner Jacket Type

Overall Jacket

Code	Material
1	PVC
3	CPE
4	TPE
5	HDPE
6	Oil Res II
7	Haloarrest

Armor

Code	Material
2	Aluminum Interlock
3	Steel Interlock

Standard lengths may be subject to tolerance. Custom lengths may be available upon request. Contact the Belden Electronics Division Customer Service Department for additional information. 1-800-BELDEN-1.



UL Instrumentation Cable

600V Tray Cables

Industrial Grade Sunlight- and Oil-Resistant Jackets

Description	Part No.	No. of Pairs	Color Code	Standard Lengths		Standard Unit Weight		Jacket Thickness		Nominal OD		Maximum Pull Tension		Minimum Bend Radius	
				Ft.	m	Lbs.	kg	Inch	mm	Inch	mm	Lbs.	N	Inch	mm

18 AWG Pairs Stranded (19x30) Tinned Copper Conductors • Twisted Pairs

Unshielded • PVC/Nylon Insulation • Black PVC Jacket

NEC: TC, NPLF ICEA S-73-532, ICEA S-61-402 ICEA T-29-520 FT4/IEEE 1202/383	9486	1	E2	1000	304.8	43.0	19.5	.048	1.22	.275	6.99	50	222	2.75	69.85
---	-------------	---	----	------	-------	------	------	------	------	------	------	----	-----	------	-------

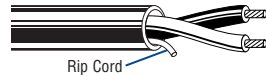

Overall Beldfoil® Shield (100% Coverage) • PVC/Nylon Insulation • Black PVC Jacket

NEC: TC, NPLF ICEA S-73-532, ICEA S-61-402 ICEA T-29-520 FT4/IEEE 1202/383	9341	1	E2	500	152.4	22.0	10.0	.048	1.22	.276	7.01	63	280	2.75	69.85
				1000	304.8	43.0	19.5								

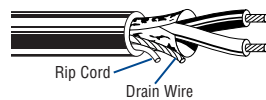

18 AWG Pairs Stranded (7x26) Bare Copper Conductors • Twisted Pairs

Overall Beldfoil Shield (100% Coverage) • PVC/Nylon Insulation • Black PVC Jacket (See chart below for other options)

NEC: TC, NPLF ICEA S-73-532 ICEA S-61-402 ICEA T-29-520 FT4/IEEE 1202/383	1120A	1	E2	10000 †	3048.0	450.0	204.3	.048	1.22	.278	7.06	59	262	2.80	71.12
	3088A	1	E1	10000 †	3048.0	510.0	231.3	.048	1.22	.278	7.06	67	298	2.80	71.12
	1063A	2	E1	10000 †	3048.0	790.0	358.3	.053	1.35	.407	10.34	112	498	4.10	104.14
	1064A	4	E1	7500 †	2286.0	892.5	404.8	.053	1.35	.470	11.94	202	899	4.70	119.38
	1065A	8	E1	7500 †	2286.0	1650.0	748.4	.064	1.63	.599	15.21	381	1695	6.00	152.40
	1066A	12	E1	5000 †	1524.0	1520.0	689.5	.064	1.63	.717	18.21	560	2491	7.20	182.88
	1067A	16	E1	5000 †	1524.0	1905.0	864.1	.064	1.63	.793	20.14	739	3287	8.00	203.20
	1068A	24	E1	2500 †	762.0	1487.5	674.7	.084	2.13	1.017	25.83	1098	4884	10.30	261.62
	1087A	36	E1	1250 †	381.0	1005.0	455.9	.084	2.13	1.178	29.97	1635	7273	11.70	297.18
	1088A	50	E1	Bulk ††	Bulk	—	—	.084	2.13	1.446	36.73	2262	10062	14.50	368.30

Individually Shielded + Overall Beldfoil Shield (100% Coverage) • PVC/Nylon Insulation • Black PVC Jacket (Options below)

NEC: TC, NPLF ICEA S-73-532 ICEA S-61-402 ICEA T-29-520 FT4/IEEE 1202/383	1048A	2	E1	7500 †	2286.0	622.5	282.4	.048	1.22	.381	9.68	140	623	3.80	96.52
	1049A	4	E1	7500 †	2286.0	1057.5	479.7	.053	1.35	.489	12.42	258	1148	4.90	124.46
	1050A	8	E1	7500 †	2286.0	1965.0	891.3	.064	1.63	.654	16.61	350	1557	6.60	167.64
	1051A	12	E1	5000 †	1524.0	1915.0	868.6	.064	1.63	.785	19.94	728	3238	7.90	200.66
	1052A	16	E1	2500 †	762.0	1267.5	574.9	.084	2.13	.898	22.81	963	4284	9.00	228.60
	1053A	24	E1	2500 †	762.0	1907.5	865.2	.084	2.13	1.115	28.32	1434	6379	11.10	281.94
	1054A	36	E1	1250 †	381.0	1270.0	576.1	.084	2.13	1.299	32.99	2139	9515	13.00	330.20
	1038A	50	E1	Bulk ††	Bulk	—	—	.084	2.13	1.527	38.79	2962	13176	15.30	388.62

E1, E2 = Refer to Technical Information section for color code. Alternate color coding available upon request. Multiple pair or triad cables have each pair/triad numbered for ease of identification.

†Final put-up length may vary ±10% from length shown.
 ††Bulk = Check length available for specific construction.

Conductor, Insulation and Jacket Options**

To Specify:			Bare	Tinned	Insulation/Jacket
1234	A	E	A	B	PVC-Nylon/PVC
Start with Part No.	Add or replace letter code for desired conductor, insulation & jacket	Add for Exposed Run rating if desired	C	D	XLPE/PVC
			E	F	FRPO/PVC
			G	H	XLPE/TPE
			K	L	TPE/TPE
			M	N	PVC-Nylon/Oil Res II
			Q	R	XLPE/CPE
			S	T	XLPE/Haloarrest®

**For 1000 and 3000 Series cables only.



For more information, contact Belden Technical Support: 1-800-BELDEN-1 • www.belden.com

UL Instrumentation Cable

600V Tray Cables

Industrial Grade Sunlight- and Oil-Resistant Jackets

Description	Part No.	No. of Pairs/Triads	Color Code	Standard Lengths		Standard Unit Weight		Jacket Thickness		Nominal OD		Maximum Pull Tension		Minimum Bend Radius	
				Ft.	m	Lbs.	kg	Inch	mm	Inch	mm	Lbs.	N	Inch	mm

18 AWG Pairs Stranded (7x26) Bare Copper Conductors • Twisted Pairs

Overall Beldfoil Shield (100% Coverage) • PVC/Nylon Insulation • Black PVC Jacket (Green Ground)

NEC: TC-ER, NPLF ICEA S-73-532 ICEA S-61-402 ICEA T-29-520 FT4/IEEE 1202/383	3088AE	1	E1	1000	3048.0	63.0	28.6	.048	1.22	.340	8.64	80	356	3.40	86.36
				5000†	1524.0	320.0	145.3								

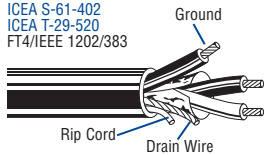

Overall Beldfoil Shield (100% Coverage) • XLPE Insulation • Black PVC Jacket (Green Ground)

NEC: TC-ER, NPLF ICEA S-73-532 ICEA S-66-524 ICEA T-29-520 FT4/IEEE 1202/383	3088CE	1	E1	1000	3048.0	66.0	30.0	.048	1.22	.340	8.64	80	356	3.40	86.36
				5000†	1524.0	375.0	170.3								

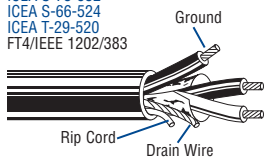

18 AWG Triads Stranded (7x26) Bare Copper Conductors • Twisted Triads

Overall Beldfoil® Shield (100% Coverage) • PVC/Nylon Insulation • Black PVC Jacket (See chart below for other options)

NEC: TC, NPLF ICEA S-73-532 ICEA S-61-402 ICEA T-29-520 FT4/IEEE 1202/383	1121A	1	E2	500†	152.4	27.5	12.5	.048	1.22	.282	7.16	90	400	2.75	69.85		
				1000†	304.8	53.0	24.0										
				10000†	3048.0	560.0	254.0										

	3089A	1	E1	10000†	3048.0	590.0	267.6	.048	1.22	.284	7.21	90	400	2.75	69.85
--	--------------	---	----	--------	--------	-------	-------	------	------	------	------	----	-----	------	-------

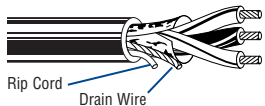

Individually Shielded + Overall Beldfoil Shield (100% Coverage) • PVC/Nylon Insulation • Black PVC Jacket (Options below)

NEC: TC, NPLF ICEA S-73-532 ICEA S-61-402 ICEA T-29-520 FT4/IEEE 1202/383	3064A	2	E1	Bulk††	Bulk	—	—	.048	1.22	.493	12.52	185	823	4.75	120.65
	1093A	4	E1	7500†	2286.0	1545.0	700.8	.063	1.60	.577	14.66	347	1544	6.00	152.40
	1094A	8	E1	5000†	1524.0	1755.0	796.1	.063	1.60	.745	18.92	672	2989	7.50	190.50
	1095A	12	E1	2500†	762.0	1320.0	598.8	.084	2.13	.944	23.98	997	4435	9.75	247.65
				5000†	1524.0	2875.0	1304.1								
	3066A	16	E1	Bulk††	Bulk	—	—	.084	2.13	1.046	26.57	1322	5881	10.50	266.70

	1096A	24	E1	Bulk††	Bulk	—	—	.084	2.13	1.284	32.61	1971	8767	13.00	330.20
--	--------------	----	----	--------	------	---	---	------	------	-------	-------	------	------	-------	--------



E1, E2 = Refer to Technical Information section for color code.
 Alternate color coding available upon request.

Multiple pair or triad cables have each pair/triad numbered for ease of identification.

†Final put-up length may vary ±10% from length shown.

††Bulk = Check length available for specific construction.

Conductor, Insulation and Jacket Options

To Specify:			Bare	Tinned	Insulation/Jacket
1234	A	E	A	B	PVC-Nylon/PVC
Start with Part No.	Add or replace letter code for desired conductor, insulation & jacket	Add for Exposed Run rating if desired	C	D	XLPE/PVC
			E	F	FRPO/PVC
			G	H	XLPE/TPE
			K	L	TPE/TPE
			M	N	PVC-Nylon/Oil Res II
			Q	R	XLPE/CPE
			S	T	XLPE/Haloarrest®



UL Instrumentation Cable

600V Tray Cables

Industrial Grade Sunlight- and Oil-Resistant Jackets

Description	Part No.	No. of Pairs	Color Code	Standard Lengths		Standard Unit Weight		Jacket Thickness		Nominal OD		Maximum Pull Tension		Minimum Bend Radius	
				Ft.	m	Lbs.	kg	Inch	mm	Inch	mm	Lbs.	N	Inch	mm

16 AWG Pairs Stranded (19x29) Tinned Copper Conductors • Twisted Pairs

Unshielded • PVC/Nylon Insulation • Black PVC Jacket

NEC: TC, NPLF ICEA S-73-532, ICEA S-61-402 ICEA T-29-520 FT4/IEEE 1202/383	9487	1	E2	500	152.4	25.5	11.6	.048	1.22	.295	7.49	70	311	3.00	76.20
				1000	304.8	54.0	24.5								

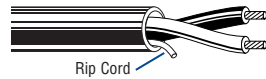

Overall Beldfoil® Shield (100% Coverage) • PVC/Nylon Insulation • Black PVC Jacket

NEC: TC, NPLF ICEA S-73-532, ICEA S-61-402 ICEA T-29-520 FT4/IEEE 1202/383	9342	1	E2	500	152.4	27.5	12.7	.048	1.22	.296	7.52	105	467	3.00	76.20
				1000	304.8	56.0	25.4								

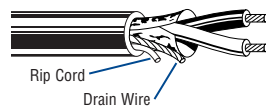

16 AWG Pairs Stranded (7x24) Bare Copper Conductors • Twisted Pairs

Overall Beldfoil Shield (100% Coverage) • PVC/Nylon Insulation • Black PVC Jacket (See chart below for other options)

NEC: TC, NPLF ICEA S-73-532 ICEA S-61-402 ICEA T-29-520 FT4/IEEE 1202/383	1118A	1	E2	10000 †	3048.0	550.0	249.5	.047	1.19	.294	7.47	105	467	3.00	76.20
	3090A	1	E1	2500 †	762.0	150.0	68.0	.047	1.19	.295	7.49	105	467	3.00	76.20
	1069A	2	E1	7500 †	2286.0	712.5	323.2	.047	1.19	.456	11.58	179	796	4.60	116.84
	1527A	3	E1	7500 †	2286.0	1042.5	472.9	.047	1.19	.482	12.24	241	1072	4.80	121.92
	1070A	4	E1	7500 †	2286.0	1357.5	615.8	.063	1.60	.560	14.22	321	1428	5.60	142.24
	1071A	8	E1	7500 †	2286.0	2242.5	1017.2	.063	1.60	.676	17.17	607	2700	6.80	172.72
	1072A	12	E1	5000 †	1524.0	1047.5	475.2	.063	1.60	.812	20.63	893	3972	8.10	205.74
	1073A	16	E1	2500 †	762.0	1442.5	654.3	.085	2.16	.946	24.03	1178	5240	9.30	236.22
	1074A	24	E1	1250 †	381.0	2115.0	959.4	.085	2.16	1.158	29.41	1749	7780	11.60	294.64
	1089A	36	E1	1250 †	381.0	1388.7	629.9	.085	2.16	1.321	33.55	2606	11592	13.20	335.28
	1090A	50	E1	Bulk ††	Bulk	—	—	.085	2.16	1.551	39.40	3606	16040	15.50	393.70

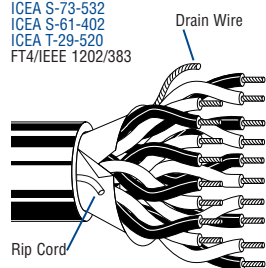

Individually Shielded + Overall Beldfoil Shield (100% Coverage) • PVC/Nylon Insulation • Black PVC Jacket (Options below)

NEC: TC, NPLF ICEA S-73-532 ICEA S-61-402 ICEA T-29-520 FT4/IEEE 1202/383	1055A	2	E1	7500 †	2286.0	885.0	401.8	.047	1.19	.476	12.09	223	992	4.16	105.66
	1037A	3	E1	7500 †	2286.0	1072.5	486.5	.047	1.19	.504	12.80	290	1290	5.00	127.0
	1039A	4	E1	7500 †	2286.0	1472.5	667.9	.063	1.60	.584	14.83	411	1828	5.80	147.32
	1040A	6	E1	5000 †	1524.0	1435.0	650.9	.063	1.60	.682	17.32	428	1904	6.80	172.72
	1041A	8	E1	5000 †	1524.0	1805.0	818.8	.063	1.60	.738	18.75	786	3496	7.40	187.96
	1042A	12	E1	2500 †	762.0	1327.5	602.2	.085	2.16	.935	23.75	1161	5164	9.40	238.76
	1043A	16	E1	2500 †	762.0	1765.0	800.6	.085	2.16	1.035	26.29	1537	6837	10.40	264.16
	1044A	20	E1	2500 †	762.0	2062.5	935.6	.085	2.16	1.146	29.11	1912	8505	11.50	292.10
	1045A	24	E1	1250 †	381.0	1241.3	563.1	.085	2.16	1.272	32.31	2287	10173	12.70	322.58
	1046A	36	E1	Bulk ††	Bulk	—	—	.085	2.16	1.454	36.93	3413	15182	14.50	368.30
	1047A	50	E1	Bulk ††	Bulk	—	—	.120	3.05	1.781	45.24	4726	21022	17.80	452.12

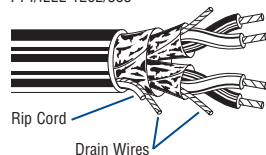

E1, E2 = Refer to Technical Information section for color code.
Alternate color coding available upon request.

Multiple pair or triad cables have each pair/triad numbered for ease of identification.

†Final put-up length may vary ±10% from length shown.

††Bulk = Check length available for specific construction.

To Specify:

1234	A	E
Start with Part No.	Add or replace letter code for desired conductor, insulation & jacket	Add for Exposed Run rating if desired

Conductor, Insulation and Jacket Options**

Bare	Tinned	Insulation/Jacket
A	B	PVC-Nylon/PVC
C	D	XLPE/PVC
E	F	FRPO/PVC
G	H	XLPE/TPE
K	L	TPE/TPE
M	N	PVC-Nylon/Oil Res II
Q	R	XLPE/CPE
S	T	XLPE/Haloarrest®

**For 1000 and 3000 Series cables only.



For more information, contact Belden Technical Support: 1-800-BELDEN-1 • www.belden.com

UL Instrumentation Cable

600V Tray Cables

Industrial Grade Sunlight- and Oil-Resistant Jackets

Description	Part No.	No. of Pairs/Triads	Color Code	Standard Lengths		Standard Unit Weight		Jacket Thickness		Nominal OD		Maximum Pull Tension		Minimum Bend Radius	
				Ft.	m	Lbs.	kg	Inch	mm	Inch	mm	Lbs.	N	Inch	mm

16 AWG Pairs Stranded (7x24) Bare Copper Conductors • Twisted Pairs

Overall Beldfoil Shield (100% Coverage) • PVC/Nylon Insulation • Black PVC Jacket (Green Ground)

NEC: TC-ER, NPLF ICEA S-73-532 ICEA S-61-402 ICEA T-29-520 FT4/IEEE 1202/383	3090AE	1	E1	1000 5000 †	304.8 1524.0	65.0 340.0	29.5 154.4	.048	1.22	.390	9.91	130	578	3.90	99.06
--	---------------	---	----	----------------	-----------------	---------------	---------------	------	------	------	------	-----	-----	------	-------

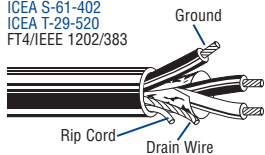

Overall Beldfoil Shield (100% Coverage) • XLPE Insulation • Black PVC Jacket (Green Ground)

NEC: TC-ER, NPLF ICEA S-73-532 ICEA S-66-524 ICEA T-29-520 FT4/IEEE 1202/383	3090CE	1	E1	1000 5000 †	3048.0 1524.0	81.0 450.0	39.8 204.3	.048	1.22	.390	9.91	130	578	3.90	99.06
--	---------------	---	----	----------------	------------------	---------------	---------------	------	------	------	------	-----	-----	------	-------

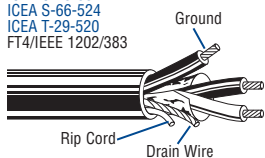

16 AWG Triads Stranded (7x24) Bare Copper Conductors • Twisted Triads

Overall Beldfoil® Shield (100% Coverage) • PVC/Nylon Insulation • Black PVC Jacket (See chart below for other options)

NEC: TC, NPLF ICEA S-73-532 ICEA S-61-402 ICEA T-29-520 FT4/IEEE 1202/383	1119A	1	E2	500 †	152.4	35.0	15.9	.047	1.19	.310	7.87	129	574	3.10	78.74	
				1000 †	304.8	68.0	30.9									
				10000 †	3048.0	700.0	317.5									
	3091A	1	E1	10000 †	3048.0	750.0	340.2	.047	1.19	.310	7.87	129	574	3.10	78.74	

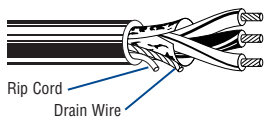

Individually Shielded + Overall Beldfoil Shield (100% Coverage) • PVC/Nylon Insulation • Black PVC Jacket (Options below)

NEC: TC, NPLF ICEA S-73-532 ICEA S-61-402 ICEA T-29-520 FT4/IEEE 1202/383	1097A	4	E1	5000 †	1524.0	1415.0	641.8	.063	1.60	.640	16.26	554	2464	6.40	162.56
	1098A	8	E1	2500 †	762.0	1350.0	612.4	.085	2.16	.872	22.15	1072	4768	8.70	220.98
	1099A	12	E1	2500 †	762.0	1875.0	850.5	.085	2.16	1.047	26.59	1590	7073	10.50	266.70
	3118A	16	E1	Bulk ††	Bulk	—	—	.084	2.13	1.234	31.34	1771	7878	12.25	311.15
	1100A	24	E1	Bulk ††	Bulk	—	—	.085	2.16	1.434	36.42	3144	13985	14.30	363.22
	3130A	36	E1	Bulk ††	Bulk	—	—	.110	2.79	1.773	45.03	3600	16013	18.00	457.20

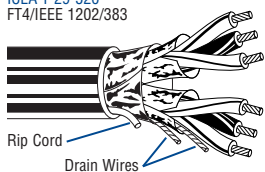

E1, E2 = Refer to Technical Information section for color code.

Alternate color coding available upon request.

Multiple pair or triad cables have each pair/triad numbered for ease of identification.

†Final put-up length may vary ±10% from length shown.

††Bulk = Check length available for specific construction.

Conductor, Insulation and Jacket Options

To Specify:			Bare	Tinned	Insulation/Jacket
1234	A	E	A	B	PVC-Nylon/PVC
Start with Part No.	Add or replace letter code for desired conductor, insulation & jacket	Add for Exposed Run rating if desired	C	D	XLPE/PVC
			E	F	FRPO/PVC
			G	H	XLPE/TPE
			K	L	TPE/TPE
			M	N	PVC-Nylon/Oil Res II
			Q	R	XLPE/CPE
			S	T	XLPE/Haloarrest®



UL Instrumentation Cable

600V Tray Cables

Industrial Grade Sunlight- and Oil-Resistant Jackets

Description	Part No.	No. of Pairs/Triads	Color Code	Standard Lengths		Standard Unit Weight		Jacket Thickness		Nominal OD		Maximum Pull Tension		Minimum Bend Radius	
				Ft.	m	Lbs.	kg	Inch	mm	Inch	mm	Lbs.	N	Inch	mm

14 AWG Pairs Stranded (42x30) Tinned Copper Conductors • Twisted Pairs

Unshielded • PVC/Nylon Insulation • Black PVC Jacket

NEC: TC, NPLF ICEA S-73-532 ICEA S-61-402 ICEA T-29-520 FT4/IEEE 1202/383	9488	1	E2	1000	304.8	77.0	34.9	.048	1.22	.359	9.12	107	476	3.75	95.25
---	-------------	---	----	------	-------	------	------	------	------	------	------	-----	-----	------	-------

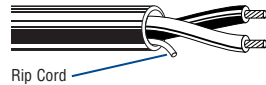

Overall Beldfoil® Shield (100% Coverage) • PVC/Nylon Insulation • Black PVC Jacket

NEC: TC, NPLF ICEA S-73-532 ICEA S-61-402 ICEA T-29-520 FT4/IEEE 1202/383	9343	1	E2	500	152.4	42.5	19.1	.048	1.22	.358	9.09	160	712	3.75	95.25
				1000	304.8	86.0	39.0								

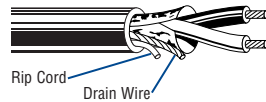

14 AWG Pairs Stranded (7x22) Bare Copper Conductors • Twisted Pairs

Overall Beldfoil Shield (100% Coverage) • PVC/Nylon Insulation • Black PVC Jacket (See chart below for other options)

NEC: TC, NPLF ICEA S-73-532 ICEA S-61-402 ICEA T-29-520 FT4/IEEE 1202/383	3080A	1	E1	Bulk*	Bulk*	—	—	.048	1.22	.342	8.69	160	712	3.50	88.90
---	--------------	---	----	-------	-------	---	---	------	------	------	------	-----	-----	------	-------

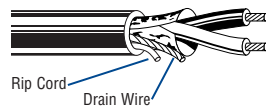

14 AWG Triads Stranded (7x22) Bare Copper Conductors • Twisted Triads

Overall Beldfoil Shield (100% Coverage) • PVC/Nylon Insulation • Black PVC Jacket (See chart below for other options)

NEC: TC, NPLF ICEA S-73-532 ICEA S-61-402 ICEA T-29-520 FT4/IEEE 1202/383	3081A	1	E1	Bulk*	Bulk*	—	—	.048	1.22	.361	9.17	200	890	3.50	88.90
---	--------------	---	----	-------	-------	---	---	------	------	------	------	-----	-----	------	-------

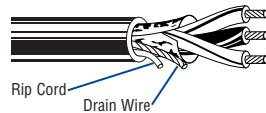

E1, E2 = Refer to Technical Information section for color code.
 Alternate color coding available upon request.

*Bulk = Check length available for specific construction.

To Specify:		
1234	A	E
Start with Part No.	Add or replace letter code for desired conductor, insulation & jacket	Add for Exposed Run rating if desired

Conductor, Insulation and Jacket Options**

Bare	Tinned	Insulation/Jacket
A	B	PVC-Nylon/PVC
C	D	XLPE/PVC
E	F	FRPO/PVC
G	H	XLPE/TPE
K	L	TPE/TPE
M	N	PVC-Nylon/Oil Res II
Q	R	XLPE/CPE
S	T	XLPE/Haloarrest®

**For 1000 and 3000 Series cables only.



For more information, contact Belden Technical Support: 1-800-BELDEN-1 • www.belden.com

UL Instrumentation Cable

600V Tray Cables

Industrial Grade Sunlight- and Oil-Resistant Jackets

Description	Part No.	No. of Pairs/Triads	Color Code	Standard Lengths		Standard Unit Weight		Jacket Thickness		Nominal OD		Maximum Pull Tension		Minimum Bend Radius	
				Ft.	m	Lbs.	kg	Inch	mm	Inch	mm	Lbs.	N	Inch	mm

12 AWG Pairs Stranded (37x27) Tinned Copper Conductors • Twisted Pairs

Unshielded • PVC/Nylon Insulation • Black PVC Jacket

NEC: TC, NPLF ICEA S-73-532 ICEA S-61-402 ICEA T-29-520 FT4/IEEE 1202/383	9489	1	E2	1000	304.8	88.0	39.9	.045	1.14	.380	9.65	170	756	3.75	95.25
---	-------------	---	----	------	-------	------	------	------	------	------	------	-----	-----	------	-------

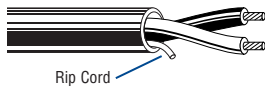

Overall Beldfoil® Shield (100% Coverage) • PVC/Nylon Insulation • Black PVC Jacket

NEC: TC, NPLF ICEA S-73-532 ICEA S-61-402 ICEA T-29-520 FT4/IEEE 1202/383	9344	1	E2	500	152.4	54.0	24.5	.045	1.14	.384	9.75	253	1125	3.75	95.25
				1000	304.8	111.0	50.4								

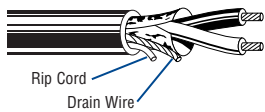

12 AWG Pairs Stranded (7x20) Bare Copper Conductors • Twisted Pairs

Overall Beldfoil Shield (100% Coverage) • PVC/Nylon Insulation • Black PVC Jacket (See chart below for other options)

NEC: TC, NPLF ICEA S-73-532 ICEA S-61-402 ICEA T-29-520 FT4/IEEE 1202/383	3103A	1	E1	Bulk*	Bulk*	—	—	.048	1.22	.380	9.65	253	1125	3.80	96.52
---	--------------	---	----	-------	-------	---	---	------	------	------	------	-----	------	------	-------

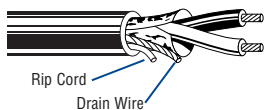

12 AWG Triads Stranded (7x20) Bare Copper Conductors • Twisted Triads

Overall Beldfoil Shield (100% Coverage) • PVC/Nylon Insulation • Black PVC Jacket (See chart below for other options)

NEC: TC, NPLF ICEA S-73-532 ICEA S-61-402 ICEA T-29-520 FT4/IEEE 1202/383	3104A	1	E1	Bulk*	Bulk*	—	—	.048	1.22	.401	10.19	315	1401	4.00	101.60
---	--------------	---	----	-------	-------	---	---	------	------	------	-------	-----	------	------	--------

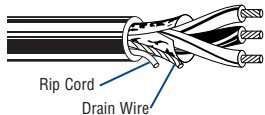

E1, E2 = Refer to Technical Information section for color code.
Alternate color coding available upon request.

*Bulk = Check length available for specific construction.

Conductor, Insulation and Jacket Options**

To Specify:			Bare	Tinned	Insulation/Jacket
1234	A	E	A	B	PVC-Nylon/PVC
Start with Part No.	Add or replace letter code for desired conductor, insulation & jacket	Add for Exposed Run rating if desired	C	D	XLPE/PVC
			E	F	FRPO/PVC
			G	H	XLPE/TPE
			K	L	TPE/TPE
			M	N	PVC-Nylon/Oil Res II
			Q	R	XLPE/CPE
			S	T	XLPE/Haloarrest®

**For 1000 and 3000 Series cables only.



UL Control Cable

600V Type TC Cables — Overview

Introduction

Belden offers a wide selection of UL-rated 600V Tray Cable for a variety of control applications.

Multi-conductor versions are available as standards from 18 to 1 AWG. 1/0 through 4/0 are also available as custom made constructions. These are unshielded and shielded versions that come with various insulation and jacket combinations.

These TC cables are installed in cable trays, ducts and conduit and can be used in direct burial applications. They are extensively used in manufacturing facilities, especially in the process industries such as petrochemical, steel, pulp and paper, cement and mining.

These flexible, space efficient cables can be substantially more economical than traditional wiring methods.

Construction

Soft annealed bare or tinned copper conductors, with various insulation and jacketing options as seen in chart below.

Application

These cables are suitable for installation in wet or dry locations. Cable jackets are resistant to sunlight, moisture and vapor penetration. The cables can be used in raceways (supported by messenger wire), outdoor applications and direct burial applications.

Unshielded

Cabled non-shielded conductors provide a minimal O.D. allowing greater tray and conduit fill. Non-shielded control cable may be utilized when recommended by the equipment manufacturer and used in a metallic conduit.

Overall Shield

Recommended for use in control applications where signals are transmitted in excess of 100 millivolts, except in areas where high voltage and current sources create excessive noise interference. The Beldfoil® shield with drain wire provides 100% coverage for maximum shield effectiveness. Copper tape shield available upon request.

Only 2-conductor round constructions can be shielded. Flat constructions cannot be shielded.

Tray Cable Construction Options

Insulation/Jacket	UL Listed for MC and TC		Flame Tests	Ratings*
	Max. Temp Rating			
	Wet	Dry		
PVC-Nylon/PVC (THHN or THWN) 14 AWG & larger	75°C	90°C	UL 1685 FT4/IEEE 1202/383 ICEA T-29-520	ICEA S-73-532 ICEA S-95-658 ICEA S-61-402
PVC-Nylon/PVC (TFN or TFFN) 16 & 18 AWG	NA	90°C	UL 1685 FT4/IEEE 1202/383 ICEA T-29-520	ICEA S-73-532 ICEA S-95-658 ICEA S-61-402
XLPE/PVC or CPE (XHHW-2) 14 AWG & larger	90°C	90°C	UL 1685 FT4/IEEE 1202/383 VW-1 rated singles ICEA T-29-520	ICEA S-73-532 ICEA S-95-658 ICEA S-66-524
XLPE/PVC or CPE (RFH-2) 16 & 18 AWG	75°C	75°C	UL 1685 FT4/IEEE 1202/383 VW-1 rated singles ICEA T-29-520	ICEA S-73-532 ICEA S-95-658 ICEA S-66-524
FRPO/PVC 18 AWG & larger	—	75°C	UL 1685	
TPE/TPE	75°C	90°C	UL 1685	
FRPO/PVC	75°C	90°C	UL 1685	
XLPE/Haloarrest® (XHHW-2) 14 AWG & larger	90°C	90°C	UL 1685 FT4/IEEE 1202/383 ICEA T-29-520	TC-LS
XLPE/Haloarrest (RFH-2) 16 & 18 AWG	75°C	75°C	UL 1685 FT4/IEEE 1202/383 ICEA T-29-520	TC-LS
FEP/PVC	90°C	90°C	UL 1685	

CPE = Chlorinated Polyethylene • FEP = Fluorinated Ethylene-propylene • FRPO = Flame-retardant Polyolefin • PVC = Polyvinyl Chloride • TPE = Thermoplastic Elastomer • XLPE = Cross-linked Polyethylene

*Applicable to TC-rated cables only.

Ground Wire

- Non-insulated, bare copper ground wires are included for constructions 8 through 1 AWG. Non-insulated, bare copper, full sized ground wires may be requested on other constructions.
- All shielded PVC-Nylon/PVC constructions include full sized ground (drain) wires.

Color Code

Multi-conductor control cables (10 AWG to 18 AWG) are printed alpha-numerically in addition to being color coded per ICEA Table E2.

8 AWG and larger are black and numbered per ICEA Method 4.

Refer to Technical Information Section for ICEA color code charts.

Specifications

- UL Subject 1277 Type TC
- XLPE/Haloarrest jacketed cables are UL 1277 TC-LS rated
- UL Subject 1424 (per outline for NPLF requirements dated May 3, 1979)
- UL 1685 (UL 1581) Vertical Flame Test comparable to IEEE 383-1974 (70,000 BTU/hr) Flame Test

- Approved for cable tray use in Class 1, Division 2 areas, per NEC Articles 340, 318 and 501, and for Class 1 circuits as permitted in Article 725
- PVC-Nylon/PVC, XLPE/PVC and XLPE/CPE constructed cables meet IEEE 1202/IEEE 383-2003/FT4 (70,000 BTU/hr) Flame Test

TC-ER Rated Cables

As an option, Belden offers all PVC-nylon/PVC, XLPE/PVC and XLPE/CPE jacketed tray cables with a TC-ER (Exposed Run) rating, formerly referred to as Open Wiring.

Per NEC Article 336, a TC-ER rated cable may be installed in an industrial establishment between a cable tray and the utilization equipment or device. A TC-ER rated cable must meet the crush and impact requirements of UL Type MC cable. By eliminating the need for metal conduit and/or armor, using a TC-ER rated cable results in savings in both installation and maintenance.

Standard lengths may be subject to tolerance. Custom lengths may be available upon request. Contact the Belden Electronics Division Customer Service Department for additional information. 1-800-BELDEN-1

UL Control Cable

600V Type TC Cables

Industrial Grade Sunlight- and Oil-Resistant Jackets

Description	Part No.	No. of Cond.	Color Code	Standard Lengths		Weight		Jacket Thickness		Nominal OD		Maximum Pull Tension		Minimum Bend Radius	
				Ft.	m	Lbs./1000'	kg/km	Inch	mm	Inch	mm	Lbs.	N	Inch	mm

18 AWG Multi-conductor Stranded (7x26) Bare Copper Conductors

PVC/Nylon Insulation and PVC Jacket Constructions (See chart below for other options)

NEC: TC, NPLF
FT4/IEEE 1202/383
ICEA S-73-532
ICEA S-95-658
ICEA S-61-402
ICEA T-29-520

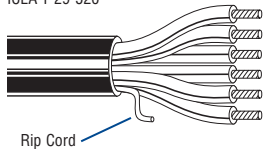

27916A [†]	2	E2	Bulk	Bulk	33.0	49.1	.045	1.14	.180 x .266	4.57 x 6.76	44	195.8	2.7	68.58
27325A ^{††}	2	E2	Bulk	Bulk	34.0	50.6	.045	1.14	.270	6.86	44	195.8	2.7	68.58
27334A	3	E2	Bulk	Bulk	45.0	67.0	.045	1.14	.280	7.11	66	293.7	2.8	71.12
27326A	4	E2	Bulk	Bulk	52.0	77.4	.045	1.14	.310	7.87	88	391.6	3.1	78.74
27335A	5	E2	Bulk	Bulk	62.0	92.3	.045	1.14	.330	8.38	110	489.5	3.3	83.82
27600A	6	E2	Bulk	Bulk	72.0	107.2	.045	1.14	.350	8.89	132	587.4	3.5	88.90
27327A	7	E2	Bulk	Bulk	79.0	117.6	.045	1.14	.350	8.89	154	685.3	3.5	88.90
27601A	8	E2	Bulk	Bulk	89.0	132.5	.045	1.14	.390	9.83	176	783.2	3.8	96.52
27336A	9	E2	Bulk	Bulk	104.0	154.8	.045	1.14	.410	10.41	198	881.1	4.1	104.14
27328A	10	E2	Bulk	Bulk	111.0	165.2	.060	1.52	.450	11.43	220	979.0	4.5	114.30
27602A	11	E2	Bulk	Bulk	—	—	.060	1.52	.450	11.43	242	1076.9	4.5	114.30
27329A	12	E2	Bulk	Bulk	127.0	189.0	.060	1.52	.450	11.43	264	1174.8	4.5	114.30
27603A	13	E2	Bulk	Bulk	142.0	211.3	.060	1.52	.470	11.94	286	1272.7	4.7	119.38
27604A	14	E2	Bulk	Bulk	—	—	.060	1.52	.480	12.19	308	1370.6	4.8	121.92
27605A	15	E2	Bulk	Bulk	175.0	260.4	.060	1.52	.510	12.95	330	1468.5	5.1	129.54
27606A	16	E2	Bulk	Bulk	167.0	248.5	.060	1.52	.500	12.70	352	1566.4	5.0	127.00
27607A	17	E2	Bulk	Bulk	—	—	.060	1.52	.570	14.48	374	1664.3	5.7	144.78
27608A	18	E2	Bulk	Bulk	196.0	291.7	.060	1.52	.570	14.48	396	1762.2	5.7	144.78
27609A	19	E2	Bulk	Bulk	202.0	300.6	.060	1.52	.570	14.48	418	1860.1	5.7	144.78
27610A	20	E2	Bulk	Bulk	214.0	318.5	.060	1.52	.600	15.24	440	1958.0	5.9	149.86
27611A	25	E2	Bulk	Bulk	258.0	384.0	.060	1.52	.660	16.76	550	2447.5	6.6	167.64
27612A	30	E2	Bulk	Bulk	300.0	446.5	.060	1.52	.690	17.53	660	2937.0	6.6	167.64
27613A	37	E2	Bulk	Bulk	360.0	535.8	.080	2.03	.740	18.80	814	3622.3	7.4	187.96
27614A	50	E2	Bulk	Bulk	511.0	760.5	.080	2.03	.910	23.11	1100	4895.0	9.1	231.14
27632A	60	E2	Bulk	Bulk	627.0	933.1	.080	2.03	.960	24.38	1320	5874.0	9.6	243.84

18 AWG Multi-conductor Stranded (7x26) Bare Copper Conductors • Overall Beldfoil® Shield (100% Coverage) with Drain Wire

PVC/Nylon Insulation and PVC Jacket Constructions (See chart below for other options)

NEC: TC, NPLF
FT4/IEEE 1202/383
ICEA S-73-532
ICEA S-95-658
ICEA S-61-402
ICEA T-29-520

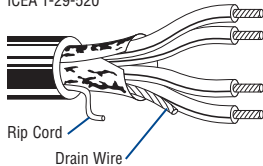

27325AS	2	E2	Bulk	Bulk	34.0	50.6	.045	1.14	.270	6.86	67	298	2.70	68.58
27334AS	3	E2	Bulk	Bulk	45.0	67.0	.045	1.14	.280	7.11	90	400	2.80	71.12
27326AS	4	E2	Bulk	Bulk	60.0	89.3	.045	1.14	.300	7.62	112	498	3.10	81.28

E2 = Refer to Technical Information section for color code.

[†] Flat construction; overall shield not available.

^{††} Twisted Conductors.

Bulk = 5000 ft. or 10,000 ft. put-up one piece, ±10%. Check length available for specific construction.

Conductor, Insulation and Jacket Options

To Specify:		
12345	A	S
Start with core Part No.	add Conductor, Insulation, Jacket type	add "S" for optional Beldfoil Shield

Bare	Tinned	Insulation/Jacket
A	B	PVC-Nylon/PVC
C	D	XLPE/PVC
E	F	FRPO/PVC
G	H	XLPE/TPE
K	L	TPE/TPE
M	N	PVC-Nylon/Oil Res II
Q	R	XLPE/CPE
S	T	XLPE/Haloarrest®

Note: To specify TC-ER (Exposed Run) rated control cable, simply replace the second digit of the part number from a Z to an 8. For example: 2Z080A with TC-ER rating becomes 28080A.



UL Control Cable

600V Type TC Cables

Industrial Grade Sunlight- and Oil-Resistant Jackets

Description	Part No.	No. of Cond.	Color Code	Standard Lengths		Weight		Jacket Thickness		Nominal OD		Maximum Pull Tension		Minimum Bend Radius	
				Ft.	m	Lbs./1000'	kg/km	Inch	mm	Inch	mm	Lbs.	N	Inch	mm

16 AWG Multi-conductor Stranded (7x24) Bare Copper Conductors

PVC/Nylon Insulation and PVC Jacket Constructions (See chart below for other options)															
NEC: TC, NPLF FT4/IEEE 1202/383 ICEA S-73-532 ICEA S-95-658 ICEA S-61-402 ICEA T-29-520	27917A†	2	E2	Bulk	Bulk	42.0	62.5	.045	1.14	.190 x .290	4.83 x 7.37	70	312	2.9	73.66
	27337A††	2	E2	Bulk	Bulk	45.0	67.0	.045	1.14	.299	7.60	70	312	2.9	73.66
	27331A	3	E2	Bulk	Bulk	55.0	81.9	.045	1.14	.307	7.80	105	467	3.1	78.74
	27338A	4	E2	Bulk	Bulk	69.0	102.7	.045	1.14	.332	8.18	140	623	3.3	83.82
	27339A	5	E2	Bulk	Bulk	83.0	123.5	.045	1.14	.360	9.14	175	779	3.6	91.44
	27615A	6	E2	Bulk	Bulk	96.0	142.9	.045	1.14	.390	9.91	210	935	3.9	99.06
	27323A	7	E2	Bulk	Bulk	106.0	157.7	.045	1.14	.390	9.91	245	1090	3.9	99.06
	27616A	8	E2	Bulk	Bulk	122.0	181.6	.045	1.14	.420	10.67	280	1246	4.2	106.68
	27340A	9	E2	Bulk	Bulk	138.0	200.4	.045	1.14	.450	11.43	315	1402	4.5	114.30
	27617A	10	E2	Bulk	Bulk	149.0	221.7	.045	1.14	.490	12.45	350	1558	4.9	124.46
	27618A	11	E2	Bulk	Bulk	161.0	239.6	.045	1.14	.490	12.45	385	1713	4.9	124.46
	27341A	12	E2	Bulk	Bulk	174.0	258.9	.045	1.14	.500	12.70	420	1869	5.0	127.00
	27619A	13	E2	Bulk	Bulk	203.0	302.1	.045	1.14	.570	14.48	455	2025	5.7	144.78
	27620A	14	E2	Bulk	Bulk	223.0	331.8	.045	1.14	.570	14.48	490	2181	5.7	144.78
	27621A	15	E2	Bulk	Bulk	229.0	340.8	.060	1.52	.590	14.99	525	2336	5.9	149.86
	27330A	16	E2	Bulk	Bulk	241.0	358.7	.045	1.14	.600	15.24	560	2492	6.0	152.40
	27622A	17	E2	Bulk	Bulk	267.0	397.3	.060	1.52	.630	16.00	595	2648	6.3	160.02
	27623A	18	E2	Bulk	Bulk	—	—	.060	1.52	.630	16.00	630	2804	6.3	160.02
	27624A	19	E2	Bulk	Bulk	287.0	427.1	.060	1.52	.630	16.00	665	2959	6.3	160.02
	27625A	20	E2	Bulk	Bulk	304.0	452.4	.060	1.52	.660	16.76	700	3115	6.6	167.64
	27324A	25	E2	Bulk	Bulk	367.0	546.1	.080	2.03	.730	18.54	875	3894	7.3	185.42
	27626A	30	E2	Bulk	Bulk	428.0	636.9	.080	2.03	.770	19.56	1050	4673	7.7	195.58
	27627A	37	E2	Bulk	Bulk	514.0	764.8	.080	2.03	.830	21.08	1295	5763	8.3	210.82
	27628A	50	E2	Bulk	Bulk	723.0	1075.8	.080	2.03	1.000	25.40	1750	7788	10.0	254.00
	27633A	60	E2	Bulk	Bulk	844.0	1255.9	.080	2.03	1.100	27.94	2100	9345	11.0	279.40

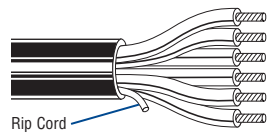

16 AWG Multi-conductor Stranded (7x24) Bare Copper Conductors • Overall Beldfoil® Shield (100% Coverage) with Drain Wire

PVC/Nylon Insulation and PVC Jacket Constructions (See chart below for other options)															
NEC: TC, NPLF FT4/IEEE 1202/383 ICEA S-73-532 ICEA S-95-658 ICEA S-61-402 ICEA T-29-520	27337AS	2	E2	Bulk	Bulk	45.0	67.0	.045	1.14	.302	7.67	94	418	3.00	76.20
	27331AS	3	E2	Bulk	Bulk	55.0	81.8	.045	1.14	.320	8.13	130	578	3.20	81.28

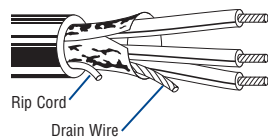

E2 = Refer to Technical Information section for color code.

† Flat construction; overall shield not available.

†† Twisted Conductors.

Bulk = 5000 ft. or 10,000 ft. put-up one piece, ±10%. Check length available for specific construction.

To Specify:		
12345	A	S
Start with core Part No.	add Conductor, Insulation, Jacket type	add "S" for optional Beldfoil Shield

Note: To specify TC-ER (Exposed Run) rated control cable, simply replace the second digit of the part number from a 7 to an 8. For example: 27080A with TC-ER rating becomes 28080A.

Conductor, Insulation and Jacket Options

Bare	Tinned	Insulation/Jacket
A	B	PVC-Nylon/PVC
C	D	XLPE/PVC
E	F	FRPO/PVC
G	H	XLPE/TPE
K	L	TPE/TPE
M	N	PVC-Nylon/Oil Res II
Q	R	XLPE/CPE
S	T	XLPE/Haloarrest®



For more information, contact Belden Technical Support: 1-800-BELDEN-1 • www.belden.com

UL Control Cable

600V Type TC Cables

Industrial Grade Sunlight- and Oil-Resistant Jackets

Description	Part No.	No. of Cond.	Color Code	Standard Lengths		Weight		Jacket Thickness		Nominal OD		Maximum Pull Tension		Minimum Bend Radius	
				Ft.	m	Lbs./1000'	kg/km	Inch	mm	Inch	mm	Lbs.	N	Inch	mm

14 AWG Multi-conductor Stranded (7x22) Bare Copper Conductors

PVC/Nylon Insulation and PVC Jacket Constructions (See chart below for other options)

NEC: TC, NPLF FT4/IEEE 1202/383 ICEA S-73-532 ICEA S-95-658 ICEA S-61-402 ICEA T-29-520	27080A †	2	E2	1000 Bulk	304.8 Bulk	61.0 61.0	27.7 27.7	.045	1.14	.210 x .320	5.33 x 8.13	108	481	3.5	88.90
	27636A ††	2	E2	Bulk	Bulk	62.0	92.3	.045	1.14	.320	8.13	108	481	3.2	81.28
	27081A	3	E2	1000 Bulk	304.8 Bulk	86.0 86.0	39.0 39.0	.045	1.14	.340	8.64	162	721	3.4	86.36
	27082A	4	E2	1000 Bulk	304.8 Bulk	110.0 110.0	49.9 49.9	.045	1.14	.360	9.14	216	961	3.6	91.44
	27083A	5	E2	Bulk	Bulk	118.0	175.6	.045	1.14	.400	10.16	270	1202	3.9	99.06
	27084A	6	E2	Bulk	Bulk	140.0	208.3	.045	1.14	.434	11.02	324	1442	4.3	109.22
	27085A	7	E2	Bulk	Bulk	153.0	227.7	.045	1.14	.433	11.00	378	1682	4.3	109.22
	27086A	8	E2	Bulk	Bulk	173.0	257.5	.045	1.14	.480	12.19	432	1922	4.7	119.38
	27087A	9	E2	Bulk	Bulk	196.0	291.7	.045	1.14	.510	12.95	486	2163	5.1	129.54
	27088A	10	E2	Bulk	Bulk	230.0	342.3	.060	1.52	.588	14.94	540	2403	5.7	144.78
	27089A	11	E2	Bulk	Bulk	251.0	373.6	.060	1.52	.595	15.11	594	2643	5.9	149.86
	27090A	12	E2	Bulk	Bulk	270.0	401.8	.060	1.52	.595	15.11	648	2884	5.9	149.86
	27091A	13	E2	Bulk	Bulk	—	—	.060	1.52	.640	16.26	702	3124	6.3	160.02
	27092A	14	E2	Bulk	Bulk	308.0	458.3	.060	1.52	.640	16.26	756	3364	6.3	160.02
	27093A	15	E2	Bulk	Bulk	330.0	491.1	.060	1.52	.670	17.02	810	3605	6.7	170.18
	27094A	16	E2	Bulk	Bulk	343.0	510.5	.060	1.52	.671	17.04	864	3845	6.6	167.64
	27095A	17	E2	Bulk	Bulk	—	—	.060	1.52	.700	17.78	918	4085	7.0	177.80
	27096A	18	E2	Bulk	Bulk	—	—	.060	1.52	.700	17.78	972	4325	7.0	177.80
	27097A	19	E2	Bulk	Bulk	396.0	589.3	.060	1.52	.705	17.91	1026	4566	7.0	177.80
	27098A	20	E2	Bulk	Bulk	425.0	632.5	.060	1.52	.735	18.67	1080	4806	7.4	187.96
	27099A	21	E2	Bulk	Bulk	438.0	651.7	.060	1.52	.740	18.80	1134	5046	7.4	187.96
	27100A	22	E2	Bulk	Bulk	—	—	.060	1.52	.760	19.30	1188	5287	7.6	193.04
	27101A	23	E2	Bulk	Bulk	—	—	.060	1.52	.760	19.30	1242	5527	7.6	193.04
	27102A	24	E2	Bulk	Bulk	495.0	736.7	.060	1.52	.810	20.57	1296	5767	8.1	205.74
	27103A	25	E2	Bulk	Bulk	560.0	833.4	.060	1.52	.810	20.57	1350	6008	8.1	205.74
	27104A	26	E2	Bulk	Bulk	—	—	.060	1.52	.810	20.57	1404	6248	8.1	205.74
	27105A	27	E2	Bulk	Bulk	587.0	873.5	.080	2.03	.870	22.10	1458	6488	8.7	220.98
	27106A	28	E2	Bulk	Bulk	—	—	.080	2.03	.910	23.11	1512	6728	9.1	231.14
	27107A	29	E2	Bulk	Bulk	680.0	1012.0	.080	2.03	.910	23.11	1566	6969	9.1	231.14
	27108A	30	E2	Bulk	Bulk	639.0	950.8	.080	2.03	.902	22.91	1620	7209	9.0	228.60
	27629A	37	E2	Bulk	Bulk	768.0	1142.9	.080	2.03	.975	24.77	1998	8891	9.7	246.38
	27912A	50	E2	Bulk	Bulk	1080.0	1607.3	.080	2.03	1.138	28.91	2700	12015	11.3	287.02

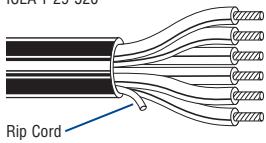

14 AWG Multi-conductor Stranded (7x22) Bare Copper Conductors • Overall Beldfoil® Shield (100% Coverage) with Drain Wire

PVC/Nylon Insulation and PVC Jacket Constructions (See chart below for other options)

NEC: TC, NPLF FT4/IEEE 1202/383 ICEA S-73-532, ICEA S-95-658 ICEA S-61-402, ICEA T-29-520	27081AS	3	E2	Bulk	Bulk	80.0	119.1	.045	1.14	.340	8.64	99	440	3.4	86.36
	27082AS	4	E2	Bulk	Bulk	105.0	156.3	.045	1.14	.391	9.93	273	1214	3.9	99.06

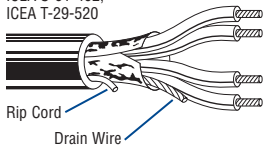

E2 = Refer to Technical Information section for color code.

† Flat construction; overall shield not available.

†† Twisted Conductors.

Bulk = 5000 ft. or 10,000 ft. put-up one piece, ±10%. Check length available for specific construction.

Conductor, Insulation and Jacket Options

To Specify:		
12345	A	S
Start with core Part No.	add Conductor, Insulation, Jacket type	add "S" for optional Beldfoil Shield

Bare	Tinned	Insulation/Jacket
A	B	PVC-Nylon/PVC
C	D	XLPE/PVC
E	F	FRPO/PVC
G	H	XLPE/TPE
K	L	TPE/TPE
M	N	PVC-Nylon/Oil Res II
Q	R	XLPE/CPE
S	T	XLPE/Haloarrest®

Note: To specify TC-ER (Exposed Run) rated control cable, simply replace the second digit of the part number from a 7 to an 8. For example: 27080A with TC-ER rating becomes 28080A.



UL Control Cable

600V Type TC Cables

Industrial Grade Sunlight- and Oil-Resistant Jackets

Description	Part No.	No. of Cond.	Color Code	Standard Lengths		Weight		Jacket Thickness		Nominal OD		Maximum Pull Tension		Minimum Bend Radius	
				Ft.	m	Lbs./1000'	kg/km	Inch	mm	Inch	mm	Lbs.	N	Inch	mm

12 AWG Multi-conductor Stranded (7x20) Bare Copper Conductors

PVC/Nylon Insulation and PVC Jacket Constructions (See chart below for other options)

NEC: TC, NPLF
 FT4/IEEE 1202/383
 ICEA S-73-532
 ICEA S-95-658
 ICEA S-61-402
 ICEA T-29-520

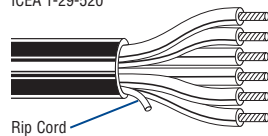

	27109A [†]	2	E2	1000 Bulk	304.8 Bulk	74.0 74.0	110.0 110.0	.045	1.14	.220 x .350	5.59 x 8.89	172	765	3.5	88.90
	27641A ^{††}	2	E2	Bulk	Bulk	86.0	128.0	.045	1.14	.360	9.14	172	765	3.6	91.44
	27110A	3	E2	1000 Bulk	304.8 Bulk	110.0 110.0	163.7 163.7	.045	1.14	.374	9.50	258	1148	3.7	93.98
	27111A	4	E2	1000 Bulk	304.8 Bulk	134.0 134.0	199.0 199.0	.045	1.14	.410	10.41	344	1531	4.1	104.14
	27112A	5	E2	Bulk	Bulk	165.0	245.6	.045	1.14	.450	11.43	430	1914	4.5	114.30
	27113A	6	E2	Bulk	Bulk	197.0	293.2	.045	1.14	.480	12.19	516	2296	4.8	121.92
	27114A	7	E2	Bulk	Bulk	216.0	321.5	.045	1.14	.480	12.19	602	2679	4.8	121.92
	27115A	8	E2	Bulk	Bulk	263.0	391.4	.060	1.52	.560	14.22	688	3062	5.6	142.24
	27116A	9	E2	Bulk	Bulk	297.0	442.0	.060	1.52	.600	15.24	774	3444	6.0	152.40
	27117A	10	E2	Bulk	Bulk	324.0	482.2	.060	1.52	.660	16.76	860	3827	6.6	167.64
	27118A	11	E2	Bulk	Bulk	—	—	.060	1.52	.670	17.02	946	4210	6.7	170.18
	27119A	12	E2	Bulk	Bulk	378.0	562.5	.060	1.52	.670	17.02	1032	4592	6.7	170.18
	27120A	13	E2	Bulk	Bulk	—	—	.060	1.52	.700	17.78	1118	4975	7.0	177.80
	27121A	14	E2	Bulk	Bulk	—	—	.060	1.52	.700	17.78	1204	5358	7.0	177.80
	27122A	15	E2	Bulk	Bulk	468.0	696.5	.060	1.52	.740	18.80	1290	5741	7.4	187.96
	27123A	16	E2	Bulk	Bulk	490.0	729.2	.060	1.52	.750	19.05	1376	6123	7.5	190.50
	27124A	17	E2	Bulk	Bulk	—	—	.060	1.52	.770	19.56	1462	6506	7.7	195.58
	27125A	18	E2	Bulk	Bulk	—	—	.060	1.52	.770	19.56	1548	6889	7.7	195.58
	27126A	19	E2	Bulk	Bulk	568.0	845.3	.060	1.52	.790	20.07	1634	7271	7.9	200.66
	27127A	20	E2	Bulk	Bulk	640.0	952.4	.080	2.03	.870	22.10	1720	7654	8.7	220.98
	27128A	21	E2	Bulk	Bulk	—	—	.080	2.03	.870	22.10	1806	8037	8.7	220.98
	27129A	22	E2	Bulk	Bulk	—	—	.080	2.03	.890	22.61	1892	8419	8.9	226.06
	27130A	23	E2	Bulk	Bulk	—	—	.080	2.03	.890	22.61	1978	8802	8.9	226.06
	27131A	24	E2	Bulk	Bulk	—	—	.080	2.03	.940	23.88	2064	9185	9.4	238.76
	27132A	25	E2	Bulk	Bulk	775.0	1153.4	.080	2.03	.960	24.38	2150	9568	9.6	243.84
	27133A	26	E2	Bulk	Bulk	—	—	.080	2.03	.960	24.38	2236	9950	9.6	243.84
	27134A	27	E2	Bulk	Bulk	828.0	1232.2	.080	2.03	.960	24.38	2322	10333	9.6	243.84
	27135A	28	E2	Bulk	Bulk	—	—	.080	2.03	.990	25.15	2408	10716	9.9	251.46
	27136A	29	E2	Bulk	Bulk	—	—	.080	2.03	.990	25.15	2494	11098	9.9	251.46
	27137A	30	E2	Bulk	Bulk	910.0	1354.3	.080	2.03	1.020	25.91	2580	11481	10.2	259.08
	27630A	37	E2	Bulk	Bulk	1100.0	1637.0	.080	2.03	1.090	27.69	3182	14160	10.9	276.86
	27634A	50	E2	Bulk	Bulk	1450.0	2157.9	.080	2.03	1.300	33.02	4300	19135	13.0	330.20

E2 = Refer to Technical Information section for color code.

[†] Flat construction; overall shield not available.

^{††} Twisted Conductors.

Bulk = 5000 ft. or 10,000 ft. put-up one piece, ±10%. Check length available for specific construction.

To Specify:		
12345	A	S
Start with core Part No.	add Conductor, Insulation, Jacket type	add "S" for optional Beldfoil [®] Shield

Note: To specify TC-ER (Exposed Run) rated control cable, simply replace the second digit of the part number from a Z to an 8. For example: 27080A with TC-ER rating becomes 28080A.

Conductor, Insulation and Jacket Options

Bare	Tinned	Insulation/Jacket
A	B	PVC-Nylon/PVC
C	D	XLPE/PVC
E	F	FRPO/PVC
G	H	XLPE/TPE
K	L	TPE/TPE
M	N	PVC-Nylon/Oil Res II
Q	R	XLPE/CPE
S	T	XLPE/Haloarrest [®]



For more information, contact Belden Technical Support: 1-800-BELDEN-1 • www.belden.com

UL Control Cable

600V Type TC Cables

Industrial Grade Sunlight- and Oil-Resistant Jackets

Description	Part No.	No. of Cond.	Color Code	Standard Lengths		Weight		Jacket Thickness		Nominal OD		Maximum Pull Tension		Minimum Bend Radius	
				Ft.	m	Lbs./1000'	kg/km	Inch	mm	Inch	mm	Lbs.	N	Inch	mm

10 AWG Multi-conductor Stranded (7x18) Bare Copper Conductors

PVC/Nylon Insulation and PVC Jacket Constructions (See chart below for other options)															
NEC: TC, NPLF FT4/IEEE 1202/383 ICEA S-73-532 ICEA S-95-658 ICEA S-61-402 ICEA T-29-520	27138A [†]	2	E2	Bulk	Bulk	83.0	123.5	.045	1.14	.260 x .420	6.60 x 10.67	296	1317	4.2	106.68
	27643A ^{††}	2	E2	Bulk	Bulk	131.0	195.0	.045	1.14	.420	10.67	296	1317	4.2	106.68
	27139A	3	E2	1000 Bulk	304.8 Bulk	164.0 164.0	244.0 244.0	.045	1.14	.450	11.43	444	1976	4.5	114.30
	27140A	4	E2	1000 Bulk	304.8 Bulk	216.0 216.0	321.0 321.0	.045	1.14	.490	12.45	592	2634	4.9	124.46
	27141A	5	E2	Bulk	Bulk	276.0	410.7	.060	1.52	.570	14.48	740	3293	5.7	144.78
	27142A	6	E2	Bulk	Bulk	329.0	489.6	.060	1.52	.620	15.75	888	3952	6.2	157.48
	27143A	7	E2	Bulk	Bulk	361.0	537.2	.060	1.52	.620	15.75	1036	4610	6.2	157.48
	27144A	8	E2	Bulk	Bulk	411.0	611.7	.060	1.52	.680	17.27	1184	5269	6.8	172.72
	27145A	9	E2	Bulk	Bulk	465.0	692.0	.060	1.52	.720	18.29	1332	5927	7.2	182.88
	27146A	10	E2	Bulk	Bulk	542.0	806.6	.060	1.52	.790	20.07	1480	6586	7.9	200.66
	27147A	11	E2	Bulk	Bulk	582.0	866.0	.060	1.52	.790	20.07	1628	7245	7.9	200.66
	27148A	12	E2	Bulk	Bulk	620.0	922.7	.080	2.03	.820	20.83	1776	7903	8.2	208.28

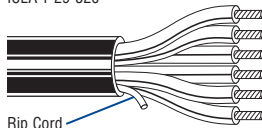

8 AWG Multi-conductor Stranded (7x16) Bare Copper Conductors • 10 AWG Bare Copper Ground Wire

PVC/Nylon Insulation and PVC Jacket Constructions (See chart below for other options)															
NEC: TC, NPLF FT4/IEEE 1202/383 ICEA S-73-532 ICEA S-95-658 ICEA S-61-402 ICEA T-29-520	27149A	2	**	Bulk	Bulk	220.0	327.4	.060	1.52	.560	14.22	384	1709	5.6	142.24
	27150A	3	**	1000 Bulk	304.8 Bulk	354.0 354.0	527.0 527.0	.060	1.52	.590	14.99	576	2563	5.9	149.86
	27151A	4	**	Bulk	Bulk	394.0	327.4	.060	1.52	.650	16.51	768	3418	6.5	165.10

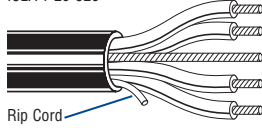

**ICEA Method 4 Color Code

6 AWG Multi-conductor Stranded (7x14) Bare Copper Conductors • 8 AWG Bare Copper Ground Wire

PVC/Nylon Insulation and PVC Jacket Constructions (See chart below for other options)															
NEC: TC, NPLF FT4/IEEE 1202/383 ICEA S-73-532 ICEA S-95-658 ICEA S-61-402 ICEA T-29-520	27152A	2	**	Bulk	Bulk	316.0	434.6	.060	1.52	.630	16.00	610	2715	6.3	160.02
	27153A	3	**	1000 Bulk	304.8 Bulk	477.0 477.0	710.0 710.0	.060	1.52	.670	17.02	915	4072	6.7	170.18
	27154A	4	**	Bulk	Bulk	519.0	759.0	.060	1.52	.730	18.54	1220	5429	7.3	185.42

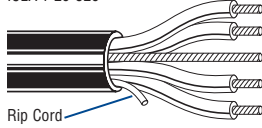

**ICEA Method 4 Color Code

E2 = Refer to Technical Information section for color code.

† Flat construction; overall shield not available.

†† Twisted Conductors.

Bulk = 5000 ft. or 10,000 ft. put-up one piece, ±10%. Check length available for specific construction.

Conductor, Insulation and Jacket Options

To Specify:		
12345	A	S
Start with core Part No.	add Conductor, Insulation, Jacket type	add "S" for optional Beldfoil® Shield

Bare	Tinned	Insulation/Jacket
A	B	PVC-Nylon/PVC
C	D	XLPE/PVC
E	F	FRPO/PVC
G	H	XLPE/TPE
K	L	TPE/TPE
M	N	PVC-Nylon/Oil Res II
Q	R	XLPE/CPE
S	T	XLPE/Haloarrest®

Note: To specify TC-ER (Exposed Run) rated control cable, simply replace the second digit of the part number from a Z to an 8. For example: 2Z080A with TC-ER rating becomes 28080A.



UL Control Cable

600V Type TC Cables

Industrial Grade Sunlight- and Oil-Resistant Jackets

Description	Part No.	No. of Cond.	Color Code	Standard Lengths		Weight		Jacket Thickness		Nominal OD		Maximum Pull Tension		Minimum Bend Radius	
				Ft.	m	Lbs./1000'	kg/km	Inch	mm	Inch	mm	Lbs.	N	Inch	mm

4 AWG Multi-conductor Stranded (7x12) Bare Copper Conductors • 8 AWG Bare Copper Ground Wire

PVC/Nylon Insulation and PVC Jacket Constructions (See chart below for other options)

NEC: TC, NPLF FT4/IEEE 1202/383	27155A	2	**	Bulk	Bulk	455.0	677.1	.060	1.52	.770	19.56	970	4317	7.7	195.58
ICEA S-73-532	27156A	3	**	Bulk	Bulk	630.0	937.6	.080	2.03	.820	20.83	1455	6475	8.2	208.28
ICEA S-95-658 ICEA S-61-402 ICEA T-29-520	27157A	4	**	Bulk	Bulk	850.0	1265.0	.080	2.03	.950	24.13	1940	8633	9.5	241.30

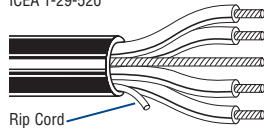

**ICEA Method 4 Color Code

2 AWG Multi-conductor Stranded (7x10) Bare Copper Conductors • 6 AWG Bare Copper Ground Wire

PVC/Nylon Insulation and PVC Jacket Constructions (See chart below for other options)

NEC: TC, NPLF FT4/IEEE 1202/383	27158A	2	**	Bulk	Bulk	716.0	1065.6	.080	2.03	.970	24.64	1544	6871	9.7	246.38
ICEA S-73-532	27159A	3	**	Bulk	Bulk	960.0	1428.7	.080	2.03	.990	25.15	2316	10306	9.9	251.46
ICEA S-95-658 ICEA S-61-402 ICEA T-29-520	27160A	4	**	Bulk	Bulk	1213.0	1805.2	.080	2.03	1.090	27.69	3088	13742	10.9	276.86

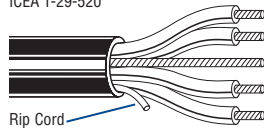

**ICEA Method 4 Color Code

1 AWG Multi-conductor Stranded (19x14) Bare Copper Conductors • 6 AWG Bare Copper Ground Wire

PVC/Nylon Insulation and PVC Jacket Constructions (See chart below for other options)

NEC: TC, NPLF FT4/IEEE 1202/383	27161A	3	**	Bulk	Bulk	—	—	.080	2.03	1.120	28.45	2919	12990	11.2	284.48
ICEA S-73-532 ICEA S-95-658 ICEA S-61-402 ICEA T-29-520															

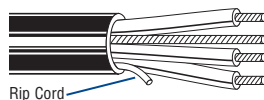

**ICEA Method 4 Color Code

Bulk = 5000 ft. or 10,000 ft. put-up one piece, ±10%. Check length available for specific construction.

Conductor, Insulation and Jacket Options

To Specify:		
12345	A	S
Start with core Part No.	add Conductor, Insulation, Jacket type	add "S" for optional Beldfoil® Shield

Note: To specify TC-ER (Exposed Run) rated control cable, simply replace the second digit of the part number from a **Z** to an **8**. For example: **2Z080A** with TC-ER rating becomes **28080A**.

Bare	Tinned	Insulation/Jacket
A	B	PVC-Nylon/PVC
C	D	XLPE/PVC
E	F	FRPO/PVC
G	H	XLPE/TPE
K	L	TPE/TPE
M	N	PVC-Nylon/Oil Res II
Q	R	XLPE/CPE
S	T	XLPE/Haloarrest®



UL Control Cable

600V Type MC Metal Clad and Teck-Style® Cables — Overview

Metal Clad

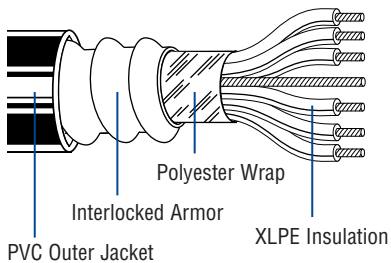

Teck-Style

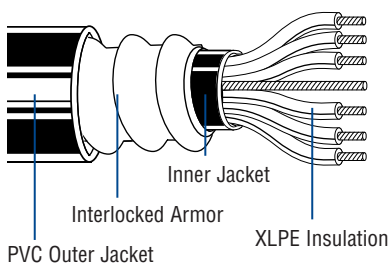

Introduction

Belden® Metal Clad (MC) and Teck-Style cables are designed to meet demanding industrial needs by combining rugged durability and corrosion resistance with flexibility and easy handling.

MC and Teck-Style cables are available in a wide range of constructions to meet the needs of pulp and paper, chemical, petroleum and other demanding industrial and resource industry environments. They are ideal for use in wet or dry areas; ventilated, non-ventilated or ladder-type cable troughs; ventilated flexible cableways; and for direct burial. Custom cables are available to meet exacting requirements.

Belden Type MC Cable is marked sunlight-resistant for cable tray use in direct burial designations, and cable constructions are listed to NEC Type MC.

Teck-Style cables are price-competitive, high-performance, UL and CSA dual-rated cables with a flame-retardant XHHW insulated conductor and an inner PVC jacket for mechanical moisture and corrosion protection.

Construction

Class B stranded bare copper conductors, cross-linked polyethylene insulation, bare copper ground wire, standard aluminum or optional galvanized steel interlocking armor, PVC outer jacket.

- Thermoset insulation — XHHW-2 conductors
- NEC conductor temperature 90°C dry and 90°C wet

Voltage Rating

14 AWG — 2 AWG: 600 Volt

Application

Type MC Cable is a general-purpose cable used in the pulp and paper, mining, petroleum and chemical industries as well as in commercial buildings.

MC Cable may be used under the following conditions:

- Exposed or concealed wiring in dry or wet conditions
- In ventilated, non-ventilated or ladder-type cable trays in dry or wet conditions
- On walls or beams
- Directly buried
- Class I and II Div. 2 and Class III Div. 1 and 2 hazardous locations

Minimum Bending Radius

12 times the overall cable diameter

Pulling Tensions

The combined use of Kellems grips and pulling eyes is recommended.

Design Advantages

Insulation Properties

- High tensile strength
- Impact- and crush-resistant
- Heat-resistant
- Excellent elongation
- Moisture-resistant
- Good low temperature properties
- 90°C dry and 90°C wet

Electrical Properties

- High insulation resistance
- Low dielectric loss
- High dielectric strength

Other Features

- Corrosion-resistant
- Versatile and flexible
- Provides cost savings as conduit and ducts are not required

Specifications

- UL 44
- UL 1569
- UL 1685 (UL 1581) Vertical Tray Flame Test (70,000 BTU/hr)

Tech-Style CSA Specifications

- CSA C22.2 #131
- FT4 Flame Test
- HAZ LOC
- CSA C22.2 #0.3 Clause 4.31 Low Acid Gas

UL Control Cable

600V Type MC Metal Clad Cables

Industrial Grade Sunlight- and Oil-Resistant Jackets

Description	Part Number		No. of Cond.	Insulation Thickness		Outer Jacket Thickness		Armor OD		Nominal OD		Minimum Bend Radius	
	Aluminum Armor	Steel Armor		Inch	mm	Inch	mm	Inch	mm	Inch	mm	Inch	mm

14 AWG Stranded (7x22) Bare Copper Conductors • 14 AWG Bare Copper Ground Wire

Aluminum or Steel Interlocked Armor • Cross-linked Polyethylene Insulation • PVC Jacket

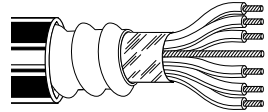
NEC: MC 	27243	28243	2	.030	.76	.050	1.27	.48	12.19	.58	14.73	7.3	185.42
	27244	28244	3	.030	.76	.050	1.27	.50	12.70	.61	15.49	7.6	193.04
	27245	28245	4	.030	.76	.050	1.27	.54	13.72	.64	16.26	7.9	200.66
	27246	28246	5	.030	.76	.050	1.27	.57	14.48	.68	17.27	8.4	213.36
	27247	28247	6	.030	.76	.050	1.27	.62	15.75	.72	18.29	8.9	226.06
	27248	28248	7	.030	.76	.050	1.27	.62	15.75	.72	18.29	8.9	226.06
	27269	28269	8	.030	.76	.050	1.27	.69	17.53	.80	20.32	9.4	238.76
	27535	28535	9	.030	.76	.050	1.27	.70	17.78	.80	20.32	10.0	254.00
	27249	28249	10	.030	.76	.050	1.27	.75	19.05	.85	21.59	10.5	266.70
	27250	28250	12	.030	.76	.050	1.27	.77	19.56	.87	22.10	10.8	274.32
	27251	28251	15	.030	.76	.050	1.27	.87	22.10	.98	24.89	11.6	294.64
	27969	28969	19	.030	.76	.050	1.27	1.00	25.40	1.11	28.19	12.1	307.34
	27252	28252	20	.030	.76	.050	1.27	1.03	26.16	1.14	28.96	13.3	337.82
	27270	28270	25	.030	.76	.050	1.27	1.10	27.94	1.21	30.73	14.4	365.76
	27253	28253	30	.030	.76	.050	1.27	1.18	29.97	1.29	32.77	15.1	383.54
	27292	28292	37	.030	.76	.050	1.27	1.14	28.96	1.24	31.50	16.1	408.94
27433	28433	40	.030	.76	.050	1.27	1.28	32.51	1.40	35.56	16.7	424.18	
27434	28434	50	.030	.76	.050	1.27	1.40	35.56	1.52	38.61	18.4	467.36	

12 AWG Stranded (7x20) Bare Copper Conductors • 12 AWG Bare Copper Ground Wire

Aluminum or Steel Interlocked Armor • Cross-linked Polyethylene Insulation • PVC Jacket

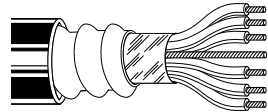
NEC: MC 	27254	28254	2	.030	.76	.050	1.27	.52	13.21	.62	15.75	7.8	198.12
	27255	28255	3	.030	.76	.050	1.27	.54	13.72	.64	16.26	8.0	203.20
	27256	28256	4	.030	.76	.050	1.27	.58	14.73	.68	17.22	8.5	215.90
	27271	28271	5	.030	.76	.050	1.27	.62	15.75	.72	18.29	9.1	231.14
	27272	28272	6	.030	.76	.050	1.27	.67	17.02	.77	19.56	9.6	243.84
	27273	28273	7	.030	.76	.050	1.27	.67	17.02	.77	19.56	9.6	243.84
	27274	28274	8	.030	.76	.050	1.27	.77	19.56	.88	22.35	10.2	259.08
	27538	28538	9	.030	.76	.050	1.27	.76	19.30	.86	21.84	10.8	274.32
	27275	28275	10	.030	.76	.050	1.27	.80	20.32	.91	23.11	11.5	292.10
	27276	28276	12	.030	.76	.050	1.27	.84	21.34	.94	23.88	11.7	297.18
	27277	28277	15	.030	.76	.050	1.27	.94	23.88	1.05	26.67	13.4	340.36
	27539	28539	19	.030	.76	.055	1.40	1.05	26.67	1.16	29.46	14.0	355.60
	27278	28278	20	.030	.76	.055	1.40	1.16	29.46	1.27	32.26	14.6	370.84
	27279	28279	25	.030	.76	.055	1.40	1.26	32.00	1.37	34.80	15.8	401.32
	27280	28280	30	.030	.76	.055	1.40	1.29	32.77	1.40	35.56	16.8	426.72
	27540	28540	37	.030	.76	.055	1.40	1.44	36.58	1.55	39.37	17.8	452.12
27432	28432	40	.030	.76	.055	1.40	1.50	38.10	1.63	41.40	18.4	467.36	

Color Code: Use ICEA Table E2 with printed numbers.

Non-stocked items. Check length available for specific construction. Minimum order may apply.

UL Control Cable

600V Type MC Metal Clad Cables

Industrial Grade Sunlight- and Oil-Resistant Jackets

Description	Part Number		No. of Cond.	Insulation Thickness		Outer Jacket Thickness		Armor OD		Nominal OD		Minimum Bend Radius	
	Aluminum Armor	Steel Armor		Inch	mm	Inch	mm	Inch	mm	Inch	mm	Inch	mm

10 AWG Stranded (7x18) Bare Copper Conductors • 10 AWG Bare Copper Ground Wire

Aluminum or Steel Interlocked Armor • Cross-linked Polyethylene Insulation • PVC Jacket

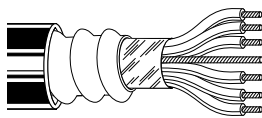
NEC: MC	27257	28257	2	.030	.76	.050	1.27	.56	14.22	.67	17.02	8.4	213.36
	27258	28258	3	.030	.76	.050	1.27	.58	14.73	.69	17.53	8.6	218.44
	27259	28259	4	.030	.76	.050	1.27	.62	15.75	.74	18.80	9.2	233.68
	27281	28281	5	.030	.76	.050	1.27	.68	17.27	.79	20.07	12.8	325.12
	27282	28282	6	.030	.76	.050	1.27	.74	18.80	.84	21.34	10.4	264.16
	27283	28283	7	.030	.76	.050	1.27	.74	18.80	.84	21.34	10.4	264.16
	27284	28284	8	.030	.76	.050	1.27	.81	20.57	.92	23.37	11.2	284.48
	27541	28541	9	.030	.76	.050	1.27	.87	22.10	.98	24.89	11.8	299.72
	27285	28285	10	.030	.76	.050	1.27	.89	22.61	1.03	26.16	13.3	337.82
	27286	28286	12	.030	.76	.050	1.27	1.01	25.65	1.12	28.45	13.7	347.98
	27287	28287	15	.030	.76	.050	1.27	1.09	27.69	1.22	30.99	14.8	375.92
	27288	28288	20	.030	.76	.055	1.40	1.22	30.99	1.35	34.29	16.2	411.48
	27289	28289	25	.030	.76	.055	1.40	1.32	33.53	1.47	37.34	17.8	452.12
	27290	28290	30	.030	.76	.055	1.40	1.42	36.07	1.55	39.37	18.6	472.44

8 AWG Stranded (7x16) Bare Copper Conductors • 10 AWG Bare Copper Ground Wire

Aluminum or Steel Interlocked Armor • Cross-linked Polyethylene Insulation • PVC Jacket

NEC: MC	27291	28291	2	.045	1.14	.050	1.27	.70	17.78	.81	20.57	9.8	248.92
	27260	28260	3	.045	1.14	.050	1.27	.72	18.29	.82	20.83	10.2	259.08
	27261	28261	4	.045	1.14	.050	1.27	.78	19.81	.88	22.35	10.9	276.86

6 AWG Stranded (7x14) Bare Copper Conductors • 8 AWG Bare Copper Ground Wire

Aluminum or Steel Interlocked Armor • Cross-linked Polyethylene Insulation • PVC Jacket

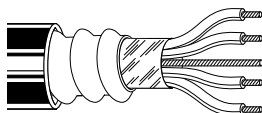
NEC: MC	27293	28293	2	.045	1.14	.050	1.27	.76	19.30	.87	22.10	10.7	271.78
	27262	28262	3	.045	1.14	.050	1.27	.80	20.32	.90	22.86	11.2	284.48
	27263	28263	4	.045	1.14	.050	1.27	.87	22.10	.97	24.64	12.1	307.34

Color Code: For sizes 14, 12, 10, use ICEA Table E2 with printed numbers.
For sizes 8 and larger, use ICEA Method 4 with printed numbers.

Non-stocked items. Check length available for specific construction. Minimum order may apply.

UL Control Cable

600V Type MC Metal Clad Cables

Industrial Grade Sunlight- and Oil-Resistant Jackets

Description	Part Number		No. of Cond.	Insulation Thickness		Outer Jacket Thickness		Armor OD		Nominal OD		Minimum Bend Radius	
	Aluminum Armor	Steel Armor		Inch	mm	Inch	mm	Inch	mm	Inch	mm	Inch	mm

4 AWG Stranded (7x12) Bare Copper Conductors • 8 AWG Bare Copper Ground Wire

Aluminum or Steel Interlocked Armor • Cross-linked Polyethylene Insulation • PVC Jacket

NEC: MC	27264	28264	3	.045	1.14	.050	1.27	.90	22.86	1.00	25.40	13.1	332.74
	27265	28265	4	.045	1.14	.050	1.27	1.97	50.04	1.08	27.43	14.2	360.68

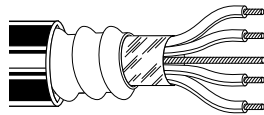

2 AWG Stranded (7x10) Bare Copper Conductors • 6 AWG Bare Copper Ground Wire

Aluminum or Steel Interlocked Armor • Cross-linked Polyethylene Insulation • PVC Jacket

NEC: MC	27267	28267	3	.045	1.14	.050	1.27	1.02	25.91	1.13	28.70	14.7	373.38
	27268	28268	4	.045	1.14	.050	1.27	1.11	28.19	1.22	30.99	16.0	406.40

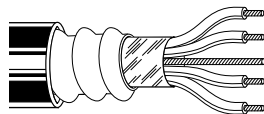

Composite 14 AWG (7x22) and 12 AWG (7x20) Stranded Bare Copper Conductors • 12 AWG Bare Copper Ground Wire

Aluminum or Steel Interlocked Armor • Cross-linked Polyethylene Insulation • PVC Jacket

NEC: MC	27428	28428	3c/14	.030	.76	.050	1.27	.70	17.78	.81	20.57	9.7	246.38
			3c/12	.030	.76								

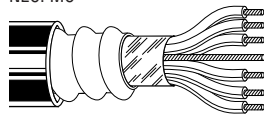

Composite 14 AWG (7x22) and 10 AWG (7x18) Stranded Bare Copper Conductors • 10 AWG Bare Copper Ground Wire

Aluminum or Steel Interlocked Armor • Cross-linked Polyethylene Insulation • PVC Jacket

NEC: MC	27429	28429	3c/14	.030	.76	.050	1.27	.74	18.80	.85	21.59	10.2	259.08
			3c/10	.030	.76								

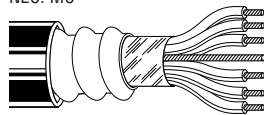

Composite 14 AWG (7x22) and 8 AWG (7x16) Stranded Bare Copper Conductors • 10 AWG Bare Copper Ground Wire

Aluminum or Steel Interlocked Armor • Cross-linked Polyethylene Insulation • PVC Jacket

NEC: MC	27430	28430	3c/14	.030	.76	.050	1.27	.83	21.08	.94	23.88	11.2	284.48
			3c/8	.045	1.14								

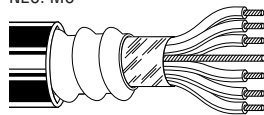

Composite 14 AWG (7x22) and 6 AWG (7x14) Stranded Bare Copper Conductors • 8 AWG Bare Copper Ground Wire

Aluminum or Steel Interlocked Armor • Cross-linked Polyethylene Insulation • PVC Jacket

NEC: MC	27431	28431	3c/14	.030	.76	.050	1.27	.89	22.61	1.01	25.65	12.0	304.80
			3c/6	.045	1.14								

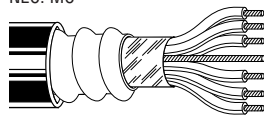

Color Code: For sizes 14, 12, 10, use ICEA Table E2 with printed numbers.
For sizes 8 and larger, use ICEA Method 4 with printed numbers.

Non-stocked items. Check length available for specific construction. Minimum order may apply.

UL Control Cable

600V Teck-Style® Cables

Dual-Rated Type MC/Teck 90

Description	Part Number		No. of Cond.	Insulation Thickness		Inner Jacket OD		Armor OD		Nominal OD		Maximum Pull Tension		Minimum Bend Radius	
	Aluminum Armor	Steel Armor		Inch	mm	Inch	mm	Inch	mm	Inch	mm	Lbs.	N	Inch	mm

14 AWG Stranded (7x22) Bare Copper Conductors • 14 AWG Bare Copper Ground Wire

Aluminum or Steel Armor • Cross-linked Polyethylene Insulation • PVC Inner Jacket • PVC Outer Jacket

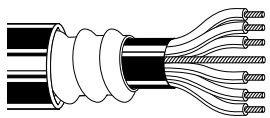
NEC: MC	27840	28840	2	.030	.76	.37	9.40	.56	14.22	.67	17.02	66	294	8.0	203
	27841	28841	3	.030	.76	.39	9.91	.58	14.73	.69	17.53	98	436	8.3	211
	27842	28842	4	.030	.76	.43	10.92	.62	15.75	.73	18.54	131	583	8.7	221
	27843	28843	5	.030	.76	.47	11.94	.66	16.76	.77	19.56	164	730	9.2	234
	27844	28844	6	.030	.76	.51	12.95	.70	17.78	.81	20.57	191	850	9.7	246
	27845	28845	7	.030	.76	.51	12.95	.70	17.78	.81	20.57	225	1001	9.7	246
	27846	28846	8	.030	.76	.58	14.73	.77	19.56	.88	22.35	260	1157	10.5	267
	27847	28847	10	.030	.76	.67	17.02	.93	23.62	1.04	26.42	321	1428	12.5	318
	27848	28848	12	.030	.76	.69	17.53	.95	24.13	1.06	26.92	388	1726	10.9	277
	27849	28849	15	.030	.76	.77	19.56	1.03	26.16	1.14	28.96	481	2140	13.7	348
	27850	28850	20	.030	.76	.86	21.84	1.12	28.45	1.23	31.24	649	2887	15.3	389
	27851	28851	25	.030	.76	.92	23.37	1.18	29.97	1.30	33.02	810	3603	16.3	414
	27852	28852	30	.030	.76	.98	24.89	1.24	31.50	1.36	34.54	975	4337	17.0	432
CSA C22.2 #131 FT4 Flame Test, HAZ LOC CSA C22.2 #0.3 Clause 4.31 Low Acid Gas	27885	28885	40	.030	.76	1.09	27.69	1.35	34.29	1.47	37.34	1301	5787	18.5	470
	27886	28886	50	.030	.76	1.19	30.23	1.45	36.83	1.57	39.88	1630	7251	19.8	503

12 AWG Stranded (7x20) Bare Copper Conductors • 12 AWG Bare Copper Ground Wire

Aluminum or Steel Armor • Cross-linked Polyethylene Insulation • PVC Inner Jacket • PVC Outer Jacket

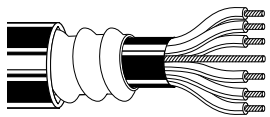
NEC: MC	27853	28853	2	.030	.76	.41	10.41	.60	15.24	.71	18.03	104	463	8.5	216
	27854	28854	3	.030	.76	.43	10.92	.62	15.75	.73	18.54	156	694	8.8	224
	27855	28855	4	.030	.76	.47	11.94	.66	16.76	.77	19.56	207	921	9.2	234
	27856	28856	5	.030	.76	.52	13.21	.71	18.03	.82	20.83	260	1157	9.8	249
	27857	28857	6	.030	.76	.59	14.99	.78	19.81	.89	22.61	310	1379	10.7	272
	27858	28858	7	.030	.76	.59	14.99	.78	19.81	.89	22.61	361	1606	10.7	272
	27859	28859	8	.030	.76	.64	16.26	.83	21.08	.94	23.88	415	1846	11.3	287
	27860	28860	10	.030	.76	.75	19.05	1.01	25.65	1.12	28.45	520	2313	13.4	340
	27861	28861	12	.030	.76	.77	19.56	1.03	26.16	1.14	28.96	619	2753	13.7	348
	27862	28862	15	.030	.76	.87	22.10	1.13	28.70	1.25	31.75	718	3194	15.0	381
	27863	28863	20	.030	.76	.96	24.38	1.22	30.99	1.33	33.78	1040	4626	15.9	404
	27864	28864	25	.030	.76	1.04	26.42	1.30	33.02	1.42	36.07	1301	5787	17.0	432
CSA C22.2 #131 FT4 Flame Test, HAZ LOC CSA C22.2 #0.3 Clause 4.31 Low Acid Gas	27865	28865	30	.030	.76	1.15	29.21	1.41	35.81	1.53	38.86	1560	6939	18.3	465
	27887	28887	40	.030	.76	1.20	30.48	1.54	39.12	1.67	42.42	2020	8985	20.0	508

Color Code: Use ICEA Table E2 with printed numbers.

Non-stocked items. Check length available for specific construction. Minimum order may apply.

UL Control Cable

600V Teck-Style® Cables

Dual-Rated Type MC/Teck 90

Description	Part Number		No. of Cond.	Insulation Thickness		Inner Jacket OD		Armor OD		Nominal OD		Maximum Pull Tension		Minimum Bend Radius	
	Aluminum Armor	Steel Armor		Inch	mm	Inch	mm	Inch	mm	Inch	mm	Lbs.	N	Inch	mm

10 AWG Stranded (7x18) Bare Copper Conductors • 10 AWG Bare Copper Ground Wire

Aluminum or Steel Armor • Cross-linked Polyethylene Insulation • PVC Inner Jacket • PVC Outer Jacket

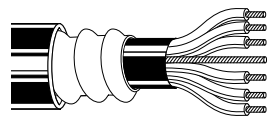
	NEC: MC	27866	28866	2	.030	.76	.46	11.68	.65	16.51	.74	18.80	166	738	9.1	231
		27867	28867	3	.030	.76	.48	12.19	.67	17.02	.77	19.56	249	1108	9.4	239
		27868	28868	4	.030	.76	.56	14.22	.75	19.05	.84	21.34	330	1468	10.3	262
		27869	28869	5	.030	.76	.67	17.02	.86	21.84	.96	24.38	415	1846	11.6	295
		27870	28870	6	.030	.76	.67	17.02	.86	21.84	.96	24.38	491	2184	11.6	295
		27877	28877	7	.030	.76	.70	17.78	.90	22.86	1.00	25.40	560	2491	12.1	307
		27878	28878	8	.030	.76	.75	19.05	.95	24.13	1.05	26.67	640	2847	12.7	323
		27879	28879	10	.030	.76	.78	19.81	1.04	26.42	1.15	29.21	801	3563	13.8	351
		27880	28880	12	.030	.76	.89	22.61	1.15	29.21	1.26	32.00	960	4270	15.1	384
		27881	28881	15	.030	.76	.93	23.62	1.19	30.23	1.30	33.02	1195	5316	15.6	396
		27882	28882	20	.030	.76	1.06	26.92	1.32	33.53	1.44	36.58	1600	7117	17.3	439
		27883	28883	25	.030	.76	1.12	28.45	1.44	36.58	1.58	40.13	1990	8852	19.0	483
		27884	28884	30	.030	.76	1.28	32.51	1.54	39.12	1.67	42.42	2355	10476	20.0	508

CSA C22.2 #131
FT4 Flame Test, HAZ LOC
CSA C22.2 #0.3 Clause 4.31 Low Acid Gas

8 AWG Stranded (7x16) Bare Copper Conductors • 10 AWG Bare Copper Ground Wire

Aluminum or Steel Armor • Cross-linked Polyethylene Insulation • PVC Inner Jacket • PVC Outer Jacket

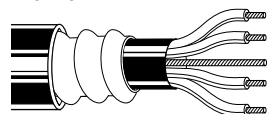
	NEC: MC	27871	28871	2	.045	1.14	.59	14.99	.78	19.81	.89	22.61	264	1174	10.7	272
		27872	28872	3	.045	1.14	.62	15.75	.81	20.57	.91	23.11	396	1762	10.9	277
		27873	28873	4	.045	1.14	.68	17.27	.94	23.88	1.05	26.67	528	2349	12.6	320

CSA C22.2 #131, FT4 Flame Test, HAZ LOC, CSA C22.2 #0.3 Clause 4.31 Low Acid Gas

6 AWG Stranded (7x14) Bare Copper Conductors • 8 AWG Bare Copper Ground Wire

Aluminum or Steel Armor • Cross-linked Polyethylene Insulation • PVC Inner Jacket • PVC Outer Jacket

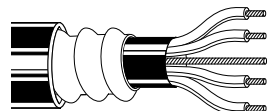
	NEC: MC	27874	28874	2	.060	1.52	.71	18.03	.97	24.64	1.08	27.43	420	1868	13.0	330
		27875	28875	3	.060	1.52	.76	19.30	1.02	25.91	1.13	28.70	630	2802	13.5	343
		27876	28876	4	.060	1.52	.88	22.35	1.14	28.96	1.25	31.75	840	3737	15.0	381

CSA C22.2 #131, FT4 Flame Test, HAZ LOC, CSA C22.2 #0.3 Clause 4.31 Low Acid Gas

4 AWG Stranded (7x12) Bare Copper Conductors • 8 AWG Bare Copper Ground Wire

Aluminum or Steel Armor • Cross-linked Polyethylene Insulation • PVC Inner Jacket • PVC Outer Jacket

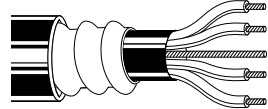
	NEC: MC	27894	28894	3	.060	1.52	.91	23.11	1.17	29.72	1.29	32.77	1002	4457	15.5	394
		27895	28895	4	.060	1.52	.99	25.15	1.25	31.75	1.37	34.80	1335	5938	16.4	417

CSA C22.2 #131, FT4 Flame Test, HAZ LOC, CSA C22.2 #0.3 Clause 4.31 Low Acid Gas

3 AWG Stranded (7x11) Bare Copper Conductors • 6 AWG Bare Copper Ground Wire

Aluminum or Steel Armor • Cross-linked Polyethylene Insulation • PVC Inner Jacket • PVC Outer Jacket

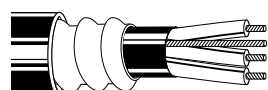
	NEC: MC	27896	28896	3	.060	1.52	.96	24.38	1.22	30.99	1.33	33.78	1263	5618	16.0	406
---	---------	--------------	--------------	---	------	------	-----	-------	------	-------	------	-------	------	------	------	-----

CSA C22.2 #131, FT4 Flame Test, HAZ LOC, CSA C22.2 #0.3 Clause 4.31 Low Acid Gas

Color Code: For sizes 14, 12, 10, use ICEA Table E2 with printed numbers.
For sizes 8 and larger, use ICEA Method 4 with printed numbers.

Non-stocked items. Check length available for specific construction. Minimum order may apply.

UL Control Cable

600V Teck-Style® Cables

Dual-Rated Type MC/Teck 90

Description	Part Number		No. of Cond.	Insulation Thickness		Inner Jacket OD		Armor OD		Nominal OD		Maximum Pull Tension		Minimum Bend Radius	
	Aluminum Armor	Steel Armor		Inch	mm	Inch	mm	Inch	mm	Inch	mm	Lbs.	N	Inch	mm

2 AWG Stranded (7x10) Bare Copper Conductors • 6 AWG Bare Copper Ground Wire

Aluminum or Steel Armor • Cross-linked Polyethylene Insulation • PVC Inner Jacket • PVC Outer Jacket

NEC: MC	27888	28888	3	.060	1.52	1.08	27.43	1.28	32.51	1.40	35.56	1593	7086	16.8	427
	27889	28889	4	.060	1.52	1.12	28.45	1.38	35.05	1.50	38.10	2124	9448	18.0	457

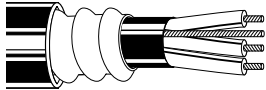

CSA C22.2 #131, FT4 Flame Test, HAZ LOC, CSA C22.2 #0.3 Clause 4.31 Low Acid Gas

Composite 14 AWG (7x22) and 12 AWG (7x20) Bare Copper Conductors • 12 AWG Bare Copper Ground Wire

Aluminum or Steel Armor • Cross-linked Polyethylene Insulation • PVC Inner Jacket • PVC Outer Jacket

NEC: MC	27890	28890	3c/14	.030	.76	.56	14.22	.75	19.05	.86	21.84	202	899	10.3	262
			3c/12	.030	.76										

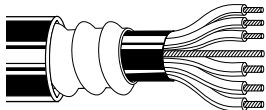

CSA C22.2 #131, FT4 Flame Test, HAZ LOC, CSA C22.2 #0.3 Clause 4.31 Low Acid Gas

Composite 14 AWG (7x22) and 10 AWG (7x18) Bare Copper Conductors • 10 AWG Bare Copper Ground Wire

Aluminum or Steel Armor • Cross-linked Polyethylene Insulation • PVC Inner Jacket • PVC Outer Jacket

NEC: MC	27891	28891	3c/14	.030	.76	.61	15.49	.80	20.32	.91	23.11	305	1357	10.9	277
			3c/10	.030	.76										

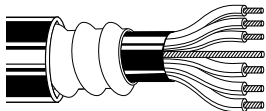

CSA C22.2 #131, FT4 Flame Test, HAZ LOC, CSA C22.2 #0.3 Clause 4.31 Low Acid Gas

Composite 14 AWG (7x22) and 8 AWG (7x16) Bare Copper Conductors • 10 AWG Bare Copper Ground Wire

Aluminum or Steel Armor • Cross-linked Polyethylene Insulation • PVC Inner Jacket • PVC Outer Jacket

NEC: MC	27892	28892	3c/14	.045	1.14	.70	17.78	.96	24.38	1.07	27.18	435	1935	12.8	325
			3c/8	.030	.76										

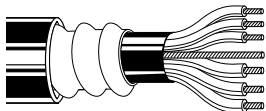

CSA C22.2 #131, FT4 Flame Test, HAZ LOC, CSA C22.2 #0.3 Clause 4.31 Low Acid Gas

Composite 14 AWG (7x22) and 6 AWG (7x14) Bare Copper Conductors • 8 AWG Bare Copper Ground Wire

Aluminum or Steel Armor • Cross-linked Polyethylene Insulation • PVC Inner Jacket • PVC Outer Jacket

NEC: MC	27893	28893	3c/14	.060	1.52	.90	22.86	1.15	29.21	1.26	32.00	655	2914	15.1	384
			3c/6	.030	.76										

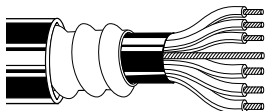

CSA C22.2 #131, FT4 Flame Test, HAZ LOC, CSA C22.2 #0.3 Clause 4.31 Low Acid Gas

Color Code: For sizes 14, 12, 10, use ICEA Table E2 with printed numbers.

For sizes 8 and larger, use ICEA Method 4 with printed numbers.

Non-stocked items. Check length available for specific construction. Minimum order may apply.

CSA Instrumentation & Thermocouple Tray Cable

300V TC/CIC

Paired and Triad Constructions

Cable Specifications

- CSA C22.2 #239 Control and Instrumentation
- CSA C22.2 #230 Type TC
- CSA FT4 70,000 BTU Flame Test
- PVC Insulation 90°C Dry & 75°C Wet
- XLPE Insulation Optional 90°C Dry and Wet
- -40°C Cold Bend, -25°C Cold Impact
- -25°C Installation temp
- Per CEC Part 1, Suitable for use in hazardous locations:
Class 1 – Zone 2
Class 2 – Division 2
- Sun Res/UV resistant
- Direct Burial

To Create a Part Number

Add suffixes for Conductor, Insulation and Jacket Type and Shielding as shown below:

A = Bare Copper Conductor or Thermocouple alloy, PVC insulation, PVC Jacket

B = Tinned Copper Conductor, PVC Insulation, PVC Jacket

C = Bare Copper Conductor or Thermocouple alloy, XLPE Insulation, PVC Jacket

D = Tinned Copper Conductor, XLPE Insulation, PVC Jacket

1 = Overall Foil Shield + Drain Wire

2 = Individual and Overall Foil Shield + Drain Wire

Sample Part Number:

22001B2 = 300V, 2-Pair 20 AWG Tinned Copper Conductor cable with PVC Insulation, PVC Jacket, with Individual and Overall Foil Shields plus Drain Wire

Thermocouple Color Codes

ANSI Symbol	Jacket Color	Insulation Color Code	
		Positive (+)	Negative (-)
EX	Purple	Purple	Red
JX	Black	White	Red
KX	Yellow	Yellow	Red
TX	Blue	Blue	Red

Copper Color Codes

Pairs/Triads	Color Combination
Pairs	Black & White
Triads	Black, White & Red

No. of Pairs	Part Numbers				
	7 Strand Copper	Solid EX Chromel/Constantan	Solid JX Iron/Constantan	Solid KX Chromel/Alumel	Solid TX Copper/Constantan
20 AWG					
1	22000	21100	21114	21128	21142
2	22001	21101	21115	21129	21143
4	22002	21102	21116	21130	21144
6	22003	21103	21117	21131	21145
8	22004	21104	21118	21132	21146
10	22005	21105	21119	21133	21147
12	22006	21106	21120	21134	21148
16	22007	21107	21121	21135	21149
20	22008	21108	21122	21136	21150
24	22009	21109	21123	21137	21151
30	22010	21110	21124	21138	21152
36	22011	21111	21125	21139	21153
40	22012	21112	21126	21140	21154
50	22013	21113	21127	21141	21155
18 AWG					
1	22027	21156	21170	21184	21198
2	22028	21157	21171	21185	21199
4	22029	21158	21172	21186	21200
6	22030	21159	21173	21187	21201
8	22031	21160	21174	21188	21202
10	22032	21161	21175	21189	21203
12	22033	21162	21176	21190	21204
16	22034	21163	21177	21191	21205
20	22035	21164	21178	21192	21206
24	22036	21165	21179	21193	21207
30	22037	21166	21180	21194	21208
36	22038	21167	21181	21195	21209
40	22039	21168	21182	21196	21210
50	22040	21169	21183	21197	21211
16 AWG					
1	22054	21212	21226	21240	21254
2	22055	21213	21227	21241	21255
4	22056	21214	21228	21242	21256
6	22057	21215	21229	21243	21257
8	22058	21216	21230	21244	21258
10	22059	21217	21231	21245	21259
12	22060	21218	21232	21246	21260
16	22061	21219	21233	21247	21261
20	22062	21220	21234	21248	21262
24	22063	21221	21235	21249	21263
30	22064	21222	21236	21250	21264
36	22065	21223	21237	21251	21265
40	22066	21224	21238	21252	21266
50	22067	21225	21239	21253	21267

Triad Constructions, Copper Conductor

No. of Triads	Part Numbers		
	20 AWG (7 Strand)	18 AWG (7 Strand)	16 AWG (7 Strand)
1	22014	22041	22068
2	22015	22042	22069
4	22016	22043	22070
6	22017	22044	22071
8	22018	22045	22072
10	22019	22046	22073
12	22020	22047	22074
16	22021	22048	22075
20	22022	22049	22076
24	22023	22050	22077
30	22024	22051	22078
36	22025	22052	22079



CSA Instrumentation Cable

300V CIC

Belden offers a complete line of high performance and high quality CSA certified instrumentation cables (300V/600V and CIC/ACIC). These cables are designed to minimize noise and signal interference to deliver clean signals in harsh petrochemical, pulp and paper and process industry environments, as well as for use in general manufacturing operations.

Contact Belden Customer Service for other options:

- 150V
- XLPE insulation (add D suffix to part number)
- Thermocouple alloy conductors
- Overall foil shield only
- Other pair and triad counts

Description	Part Number	No. of Pairs or Triads	Cable Weight		Jacket Thickness		Nominal OD	
			Lbs./1000 Ft.	kg/km	Inch	mm	Inch	mm

20 AWG Pairs Stranded (7x28) TC Conductors • Individual Beldfoil® + Polyester Isolation Tape • Overall Beldfoil Shield (100% Coverage)

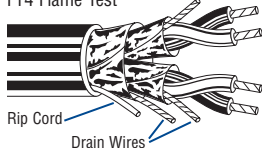
PVC Insulation • Black PVC Jacket (Color Code: Black and White with Numbers)								
CSA C22.2#239, Type CIC	22671*	1	71	106	.045	1.14	.260	6.60
CSA C22.2 #0.3 Clause 4.31 Low Acid Gas FT4 Flame Test	22638	2	143	213	.045	1.14	.400	10.16
	22639	4	217	323	.045	1.14	.460	11.68
	22640	6	320	476	.045	1.14	.570	14.48
	22641	8	405	603	.060	1.52	.610	15.49
	22676	12	573	853	.060	1.52	.730	18.54
	22643	16	722	1076	.060	1.52	.810	20.57
	22647	24	1103	1641	.080	2.03	1.040	26.42
	22670	36	1548	2304	.080	2.03	1.190	30.23

-25°C Installed • -40°C to +105°C (Dry) (75°C Wet)

20 AWG Triads Stranded (7x28) TC Conductors • Individual Beldfoil + Polyester Isolation Tape • Overall Beldfoil Shield (100% Coverage)

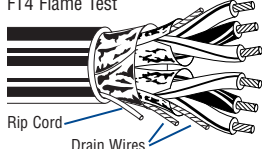
PVC Insulation • Black PVC Jacket (Color Code: Black, White and Red with Numbers)								
CSA C22.2#239, Type CIC	22660*	1	89	132	.045	1.14	.270	6.86
CSA C22.2 #0.3 Clause 4.31 Low Acid Gas FT4 Flame Test	22662	2	177	263	.045	1.14	.420	10.67
	22663	4	277	412	.045	1.14	.490	12.45
	22672	8	521	775	.060	1.52	.650	16.51
	22673	16	1000	1488	.080	2.03	.910	23.11
	22674	24	1414	2104	.080	2.03	1.110	28.19

-25°C Installed • -40°C to +105°C (Dry) (75°C Wet)

18 AWG Pairs Stranded (7x26) TC Conductors • Individual Beldfoil + Polyester Isolation Tape • Overall Beldfoil Shield (100% Coverage)

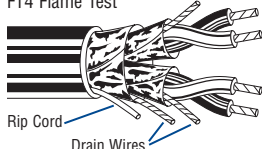
PVC Insulation • Black PVC Jacket (Color Code: Black and White with Numbers)								
CSA C22.2#239, Type CIC	22645*	1	97	144	.045	1.14	.300	7.62
CSA C22.2 #0.3 Clause 4.31 Low Acid Gas FT4 Flame Test	22633	2	196	292	.045	1.14	.480	12.19
	22648	4	338	503	.045	1.14	.580	14.73
	22634	6	473	704	.060	1.52	.670	17.02
	22635	8	570	848	.060	1.52	.730	18.54
	22636	12	869	1293	.060	1.52	.920	23.37
	22654	16	1095	1630	.080	2.03	1.020	25.91
	22637	24	1552	2310	.080	2.03	1.260	32.00

-25°C Installed • -40°C to +105°C (Dry) (75°C Wet)

18 AWG Triads Stranded (7x26) TC Conductors • Individual Beldfoil + Polyester Isolation Tape • Overall Beldfoil Shield (100% Coverage)

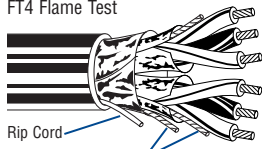
PVC Insulation • Black PVC Jacket (Color Code: Black, White and Red with Numbers)								
CSA C22.2#239, Type CIC	22677*	1	121	180	.045	1.14	.303	7.70
CSA C22.2 #0.3 Clause 4.31 Low Acid Gas FT4 Flame Test	22678	2	256	381	.045	1.14	.480	12.19
	22679	4	427	636	.060	1.52	.620	15.75
	22680	8	597	888	.060	1.52	.710	18.03
	22681	16	740	1101	.060	1.52	.770	19.56
	22682	24	1130	1682	.080	2.03	.980	24.89
	22683	16	1436	2137	.080	2.03	1.090	27.69
	22684	24	2049	3049	.080	2.03	1.340	34.04

-25°C Installed • -40°C to +105°C (Dry) (75°C Wet)

*One pair/triad cables have one shield and drain wire

TC = Tinned Copper



CSA Instrumentation Cable

300V CIC

Description	Part Number	No. of Pairs or Triads	Cable Weight		Jacket Thickness		Nominal OD	
			Lbs./1000 Ft.	kg/km	Inch	mm	Inch	mm

16 AWG Pairs Stranded (7x24) TC Conductors • Individual Beldfoil® + Polyester Isolation Tape • Overall Beldfoil Shield (100% Coverage)

PVC Insulation • Black PVC Jacket (Color Code: Black and White with Numbers)

CSA C22.2#239, Type CIC	22646*	1	122	182	.045	1.14	.320	8.13
CSA C22.2 #0.3 Clause 4.31 Low Acid Gas FT4 Flame Test	22628	2	262	390	.045	1.14	.520	13.21
	22629	4	438	652	.060	1.52	.628	15.95
	22630	6	603	897	.060	1.52	.740	18.80
	22631	8	752	1119	.060	1.52	.800	20.32
	22632	12	1148	1708	.080	2.03	1.010	25.65
	22685	16	1461	2174	.080	2.03	1.120	28.45
	22686	24	2091	3112	.080	2.03	1.380	35.05

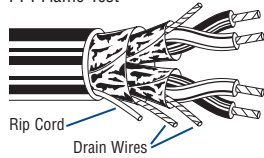

-25°C Installed
-40°C to +105°C (Dry) (75°C Wet)

16 AWG Triads Stranded (7x24) TC Conductors • Individual Beldfoil + Polyester Isolation Tape • Overall Beldfoil Shield (100% Coverage)

PVC Insulation • Black PVC Jacket (Color Code: Black, White and Red with Numbers)

CSA C22.2#239, Type CIC	22603*	1	152	226	.045	1.14	.329	8.36
CSA C22.2 #0.3 Clause 4.31 Low Acid Gas FT4 Flame Test	22687	2	344	512	.045	1.14	.580	14.73
	22675	4	564	839	.060	1.52	.670	17.02
	22688	6	819	1219	.060	1.52	.780	19.81
	22689	8	1063	1582	.080	2.03	.940	23.88
	22690	12	1524	2268	.080	2.03	1.080	27.43

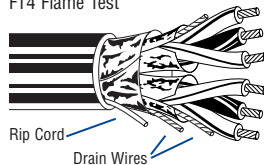

-25°C Installed
-40°C to +105°C (Dry) (75°C Wet)

TC = Tinned Copper

*One pair/triad cables have one shield and drain wire

CSA Instrumentation Cable

300V ACIC Armored Cables

Description	Part No.		No. of Pairs/Triads	Cable Weight Aluminum Armor		Cable Weight Steel Armor		Insulation Thickness		Nominal OD Inner Jacket		Nominal OD Outer Jacket	
	Aluminum Armor	Steel Armor		Lbs./1000 Ft.	kg/km	Lbs./1000 Ft.	kg/km	Inch	mm	Inch	mm	Inch	mm

20 AWG Pairs Stranded (7x28) TC Cond. • Individual Beldfoil® + Polyester Isolation Tape • Overall Beldfoil Shield (100% Coverage) • Drain Wires

Interlocked Armor • PVC Insulation* • PVC Inner Jacket • Chrome PVC Outer Jacket

CSA C22.2#239, Type ACIC	23543**	26530**	1	140	208	230	342	.020	.51	.26	6.6	.56	14.2
CSA C22.2#174, HLBCD	23534	26531	2	206	307	325	484	.020	.51	.40	10.2	.70	17.8
CSA C22.2#0.3, Clause 4.31	23514	26532	4	255	379	390	580	.020	.51	.46	11.7	.76	19.3
Low Acid Gas	23513	26533	6	297	442	494	735	.020	.51	.57	14.5	.88	22.4
FT4 Flame Test	23503	26534	8	361	537	563	840	.020	.51	.63	16.0	.92	23.4
	23521	26535	12	480	714	694	1033	.020	.51	.75	19.1	1.06	26.9
	23532	26536	16	600	893	900	1339	.020	.51	.79	20.1	1.16	29.5
	23506	26537	24	800	1191	1175	1749	.020	.51	1.05	26.7	1.42	36.1
	23544	26538	36	1050	1563	1500	2232	.020	.51	1.14	29.0	1.57	39.9
	23575	26546	50	1468	2185	2010	2991	.020	.51	1.37	34.8	1.75	44.5

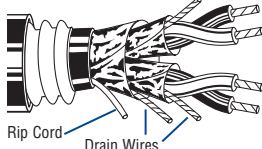

-25°C Installed
-40°C to +105°C (Dry) (75°C Wet)

20 AWG Triads Stranded (7x28) TC Cond. • Individual Beldfoil + Polyester Isolation Tape • Overall Beldfoil Shield (100% Coverage) • Drain Wires

Interlocked Armor • PVC Insulation* • PVC Inner Jacket • Chrome PVC Outer Jacket

CSA C22.2#239, Type ACIC	23545**	26539**	1	139	207	235	350	.020	.51	.27	6.9	.57	14.5
CSA C22.2#174, HLBCD	23546	26540	2	210	313	345	513	.020	.51	.43	10.9	.73	18.5
CSA C22.2#0.3, Clause 4.31	23547	26541	4	270	402	425	632	.020	.51	.50	12.7	.80	20.3
Low Acid Gas, FT4 Flame Test	23548	26542	8	444	661	650	967	.020	.51	.69	17.5	1.00	25.4
	23571	26553	12	632	941	970	1444	.020	.51	.82	20.8	1.24	31.5
	23549	26543	16	740	1101	1090	1622	.020	.51	.91	23.1	1.28	32.5
	23550	26544	24	990	1473	1360	2024	.020	.51	1.11	28.2	1.48	37.6

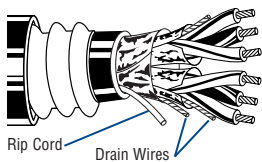

-25°C Installed • -40°C to +105°C (Dry) (75°C Wet)

18 AWG Pairs Stranded (7x26) TC Cond. • Individual Beldfoil + Polyester Isolation Tape • Overall Beldfoil Shield (100% Coverage) • Drain Wires

Interlocked Armor • PVC Insulation* • PVC Inner Jacket • Chrome PVC Outer Jacket

CSA C22.2#239, Type ACIC	23533**	26514**	1	160	238	258	384	.025	.64	.30	7.6	.60	15.2
CSA C22.2#174, HLBCD	23511	26515	2	247	368	384	572	.025	.64	.48	12.2	.78	19.8
CSA C22.2#0.3, Clause 4.31	23530	26516	4	340	506	500	744	.025	.64	.58	14.7	.88	22.4
Low Acid Gas	23528	26517	6	420	625	644	958	.025	.64	.67	17.0	.98	24.9
FT4 Flame Test	23531	26518	8	543	808	827	1230	.025	.64	.73	18.5	1.03	26.2
	23524	26519	12	725	1079	1045	1555	.025	.64	.90	22.9	1.28	32.5
	23519	26520	16	850	1265	1210	1801	.025	.64	.99	25.1	1.37	34.8
	23542	26521	24	1100	1637	1510	2247	.025	.64	1.24	31.5	1.63	41.4
	23554	26555	36	1465	2180	1960	2917	.025	.64	1.41	35.8	1.80	45.7

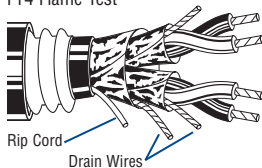

-25°C Installed • -40°C to +105°C (Dry) (75°C Wet)

18 AWG Triads Stranded (7x26) TC Cond. • Individual Beldfoil + Polyester Isolation Tape • Overall Beldfoil Shield (100% Coverage) • Drain Wires

Interlocked Armor • PVC Insulation* • PVC Inner Jacket • Chrome PVC Outer Jacket

CSA C22.2#239, Type ACIC	23505**	26522**	1	175	260	275	409	.025	.64	.33	8.4	.61	15.5
CSA C22.2#174, HLBCD	23516	26523	2	275	409	417	621	.025	.64	.51	13.0	.81	20.6
CSA C22.2#0.3, Clause 4.31	23515	26524	4	385	573	555	826	.025	.64	.62	15.7	.93	23.6
Low Acid Gas, FT4 Flame Test	23508	26525	6	535	796	780	1161	.025	.64	.75	19.1	1.11	28.2
	23523	26526	8	680	1012	995	1481	.025	.64	.81	20.6	1.18	30.0
	23512	26527	12	916	1363	1215	1808	.025	.64	1.03	26.2	1.40	35.6
	23537	26528	16	1020	1518	1400	2083	.025	.64	1.13	28.7	1.50	38.1
	23536	26529	24	1335	1987	1775	2642	.025	.64	1.37	34.8	1.80	45.7

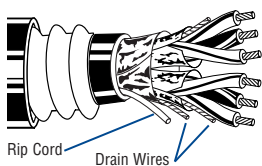

-25°C Installed • -40°C to +105°C (Dry) (75°C Wet)

Color Code: Pairs — Black and White with Numbers.
Triads — Black, White and Red with Numbers.

TC = Tinned Copper

*Note: Add D suffix for XLPE insulation. Example: 23543D.
**One pair/triad cables have one foil shield and drain wire



For more information, contact **Belden Technical Support: 1-800-BELDEN-1 • www.belden.com**

CSA Instrumentation Cable

300V ACIC Armored Cables

Description	Part No.		No. of Pairs/Triads	Cable Weight Aluminum Armor		Cable Weight Steel Armor		Insulation Thickness		Nominal OD Inner Jacket		Nominal OD Outer Jacket	
	Aluminum Armor	Steel Armor		Lbs. / 1000 Ft.	kg/km	Lbs. / 1000 Ft.	kg/km	Inch	mm	Inch	mm	Inch	mm

16 AWG Pairs Stranded (7x24) TC Conductors • Individual Beldfoil® + Polyester Isolation Tape • Overall Beldfoil Shield (100% Coverage)

Interlocked Armor • PVC Insulation* • PVC Inner Jacket • Chrome PVC Outer Jacket

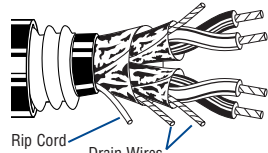
CSA C22.2#239, Type ACIC	23501**	26500**	1	175	260	280	417	.025	.64	.33	8.4	.62	15.8
CSA C22.2#174, HLBCD	23527	26501	2	280	417	425	635	.025	.64	.52	13.2	.81	20.6
CSA C22.2#0.3, Clause 4.31 Low Acid Gas	23509	26503	4	395	588	570	848	.025	.64	.63	16.0	.93	23.6
FT4 Flame Test	23500	26504	6	510	759	715	1064	.025	.64	.73	18.5	1.03	26.2
	23510	26505	8	625	930	910	1354	.025	.64	.79	20.1	1.16	29.5
	23525	26506	12	875	1302	1230	1831	.025	.64	1.00	25.4	1.37	34.8
	23539	26507	16	1054	1569	1445	2151	.025	.64	1.12	28.2	1.48	37.6
	23538	26508	24	1397	2079	1840	2738	.025	.64	1.36	34.5	1.75	44.5
	23568	26551	36	1920	2857	2460	3661	.025	.64	1.60	40.6	1.97	50.0

-25°C Installed • -40°C to +105°C (Dry) (75°C Wet)

16 AWG Triads Stranded (7x24) TC Conductors • Individual Beldfoil + Polyester Isolation Tape • Overall Beldfoil Shield (100% Coverage)

Interlocked Armor • PVC Insulation* • PVC Inner Jacket • Chrome PVC Outer Jacket

CSA C22.2#239, Type ACIC	23507**	26502**	1	190	282	295	439	.025	.64	.35	8.9	.63	16.0
CSA C22.2#174, HLBCD	23522	26509	2	342	508	500	744	.025	.64	.58	14.7	.90	22.9
CSA C22.2#0.3, Clause 4.31 Low Acid Gas	23520	26510	4	450	670	640	953	.025	.64	.68	17.3	.95	24.1
FT4 Flame Test	23529	26511	6	650	967	928	1381	.025	.64	.78	19.8	1.19	30.2
	23526	26512	8	825	1228	1130	1682	.025	.64	.93	23.6	1.30	33.0
	23541	26513	12	1082	1610	1511	2249	.025	.64	1.13	28.7	1.50	38.1
	23567	26545	16	1285	1912	1705	2537	.025	.64	1.25	31.8	1.64	41.7
	23578	26547	24	1725	2567	2200	3274	.025	.64	1.58	40.1	1.95	49.5

-25°C Installed • -40°C to +105°C (Dry) (75°C Wet)

TC = Tinned Copper

*Note: Add D suffix for XLPE insulation. Example: 23501D.

**One pair/triad cables have one foil shield and drain wire

Color Code: Pairs — Black and White with Numbers.

Triads — Black, White and Red with Numbers.

CSA Instrumentation Cable

600V CIC

Description	Part Number	No. of Pairs or Triads	Cable Weight		Jacket Thickness		Nominal OD	
			Lbs./1000 Ft.	kg/km	Inch	mm	Inch	mm

18 AWG Pairs Stranded (7x26) TC Conductors • Individual Beldfoil® + Polyester Isolation Tape • Overall Beldfoil Shield (100% Coverage)

PVC Insulation • Black PVC Jacket (Color Code: Black and White with Numbers)

CSA C22.2#239, Type CIC	22417*	1	109	162	.045	1.14	.32	8.13
CSA C22.2#0.3, Clause 4.31 Low Acid Gas FT4 Flame Test	22405	2	229	341	.045	1.14	.51	12.95
	22404	4	374	557	.060	1.52	.63	16.00
	22418	8	632	941	.060	1.52	.79	20.07
	22421	12	970	1444	.080	2.03	1.00	25.40
	22419	24	1741	2591	.080	2.03	1.36	34.54

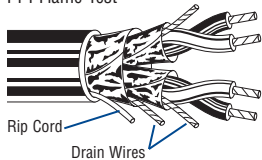

-25°C Installed
-40°C to +105°C (Dry) (75°C Wet)

18 AWG Triads Stranded (7x26) TC Conductors • Individual Beldfoil + Polyester Isolation Tape • Overall Beldfoil Shield (100% Coverage)

PVC Insulation • Black PVC Jacket (Color Code: Black, White and Red with Numbers)

CSA C22.2#239, Type CIC	22442*	1	131	195	.045	1.14	.34	8.64
CSA C22.2#0.3, Clause 4.31 Low Acid Gas FT4 Flame Test	22443	2	299	445	.060	1.52	.58	14.73
	22444	4	476	708	.060	1.52	.68	17.27
	22445	8	893	1329	.080	2.03	.88	22.35

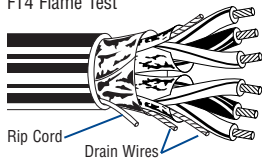

-25°C Installed
-40°C to +105°C (Dry) (75°C Wet)

16 AWG Pairs Stranded (7x24) TC Conductors • Individual Beldfoil + Polyester Isolation Tape • Overall Beldfoil Shield (100% Coverage)

PVC Insulation • Black PVC Jacket (Color Code: Black and White with Numbers)

CSA C22.2#239, Type CIC	22416*	1	129	192	.045	1.14	.34	8.64
CSA C22.2#0.3, Clause 4.31 Low Acid Gas FT4 Flame Test	22409	2	229	341	.045	1.14	.59	14.99
	22410	4	469	698	.060	1.52	.68	17.27
	22446	6	667	993	.060	1.52	.79	20.07
	22411	8	841	1252	.080	2.03	.90	22.86
	22412	12	1235	1838	.080	2.03	1.09	27.69
	22447	24	2250	3349	.080	2.03	1.49	37.85

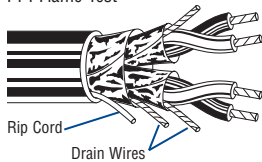

-25°C Installed
-40°C to +105°C (Dry) (75°C Wet)

16 AWG Triads Stranded (7x24) TC Conductors • Individual Beldfoil + Polyester Isolation Tape • Overall Beldfoil Shield (100% Coverage)

PVC Insulation • Black PVC Jacket (Color Code: Black, White and Red with Numbers)

CSA C22.2#239, Type CIC	22413*	1	167	249	.045	1.14	.36	9.14
CSA C22.2#0.3, Clause 4.31 Low Acid Gas FT4 Flame Test	22448	2	372	554	.045	1.14	.62	15.88
	22414	4	606	902	.060	1.52	.72	18.29
	22415	8	1144	1703	.080	2.03	.96	24.38

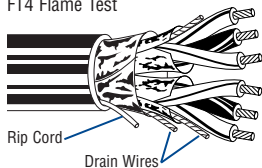

-25°C Installed
-40°C to +105°C (Dry) (75°C Wet)

TC = Tinned Copper

*One pair/triad cables have one foil shield and drain wire

CSA Instrumentation Cable

600V ACIC Armored Cables

Description	Part No.		No. of Pairs/Triads	Cable Weight Aluminum Armor		Cable Weight Steel Armor		Insulation Thickness		Nominal OD Inner Jacket		Nominal OD Outer Jacket	
	Aluminum Armor	Steel Armor		Lbs./1000 Ft.	kg/km	Lbs./1000 Ft.	kg/km	Inch	mm	Inch	mm	Inch	mm

18 AWG Pairs Stranded (7x26) TC Cond. • Individual Beldfoil® + Polyester Isolation Tape • Overall Beldfoil Shield (100% Coverage)

Interlocked Armor • PVC Insulation* • PVC Inner Jacket • Chrome PVC Outer Jacket

CSA C22.2#239, Type ACIC	24511**	25506**	1	154	229	257	382	.030	.76	.32	8.13	.61	15.49
CSA C22.2#174, HLBCD	24512	25514	2	238	354	387	575	.030	.76	.51	12.95	.82	20.83
CSA C22.2#0.3, Clause 4.31	24513	25503	4	335	499	504	750	.030	.76	.63	16.00	.93	23.62
Low Acid Gas, FT4 Flame Test	24514	25505	8	536	798	829	1233	.030	.76	.79	20.27	1.15	29.21
	24515	25501	12	739	1100	1092	1624	.030	.76	1.00	25.40	1.36	34.54
	24520	25517	24	1169	1740	1674	2490	.030	.76	1.36	34.54	1.75	44.45

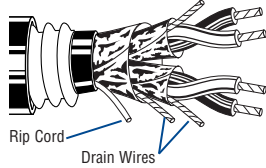

-25°C Installed • -40°C to +105°C (Dry) (75°C Wet)

18 AWG Triads Stranded (7x26) TC Conductors • Individual Beldfoil + Polyester Isolation Tape • Overall Beldfoil Shield (100% Coverage)

Interlocked Armor • PVC Insulation* • PVC Inner Jacket • Chrome PVC Outer Jacket

CSA C22.2#239, Type ACIC	24516**	25500**	1	166	247	276	411	.030	.76	.34	8.64	.63	16.00
CSA C22.2#174, HLBCD	24517	25522	2	293	436	455	677	.030	.76	.58	14.73	.89	22.61
CSA C22.2#0.3, Clause 4.31	24518	25520	4	391	582	572	851	.030	.76	.66	16.76	.99	25.15
Low Acid Gas, FT4 Flame Test	24519	25523	8	673	1002	988	1470	.030	.76	.88	22.35	1.29	32.77

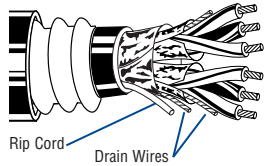

-25°C Installed • -40°C to +105°C (Dry) (75°C Wet)

16 AWG Pairs Stranded (7x24) TC Cond. • Individual Beldfoil + Polyester Isolation Tape • Overall Beldfoil Shield (100% Coverage)

Interlocked Armor • PVC Insulation* • PVC Inner Jacket • Chrome PVC Outer Jacket

CSA C22.2#239, Type ACIC	24500**	25504**	1	171	254	279	415	.030	.76	.34	8.64	.64	16.26
CSA C22.2#174, HLBCD	24505	25510	2	299	445	455	677	.030	.76	.59	14.99	.89	22.61
CSA C22.2#0.3, Clause 4.31	24502	25511	4	450	670	583	868	.030	.76	.68	17.27	.98	24.89
Low Acid Gas, FT4 Flame Test	24506	25512	6	576	857	880	1310	.030	.76	.79	20.07	1.16	29.46
	24503	25513	8	679	1010	1005	1496	.030	.76	.90	22.86	1.27	32.26
	24504	25518	12	908	1351	1280	1905	.030	.76	1.09	27.69	1.46	37.08
	24510	25519	24	1502	2235	2030	3021	.030	.76	1.49	37.85	1.88	47.75

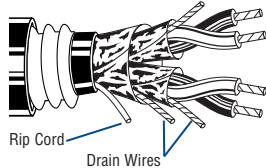

-25°C Installed • -40°C to +105°C (Dry) (75°C Wet)

16 AWG Triads Stranded (7x24) TC Conductors • Individual Beldfoil + Polyester Isolation Tape • Overall Beldfoil Shield (100% Coverage)

Interlocked Armor • PVC Insulation* • PVC Inner Jacket • Chrome PVC Outer Jacket

CSA C22.2#239, Type ACIC	24501**	25502**	1	195	290	309	460	.030	.76	.36	9.14	.66	16.76
CSA C22.2#174, HLBCD	24507	25507	2	339	505	465	692	.030	.76	.62	15.75	.94	23.88
CSA C22.2#0.3, Clause 4.31	24508	25509	4	464	691	793	1180	.030	.76	.72	18.29	1.05	26.67
Low Acid Gas, FT4 Flame Test	24509	25508	8	807	1201	1250	1860	.030	.76	.96	24.38	1.33	33.78

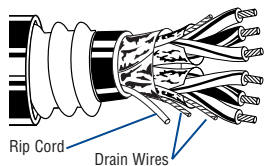

-25°C Installed • -40°C to +105°C (Dry) (75°C Wet)

Color Code: Pairs — Black and White with Numbers.
Triads — Black, White and Red with Numbers.

TC = Tinned Copper

*Note: Add D suffix for XLPE insulation. Example: 24511D.
**One pair/triad cables have one foil shield and drain wire

CSA Control and Power Cable

600V and 1000V TC/CIC Multi-conductor Cables

Cable Specifications

- CSA C22.2 #230 Type TC
- CSA C22.2 #239 Control and Instrumentation (600V only)
- CSA C22.2 #38 Type TC (1000V only)
- CSA FT4 70,000 BTU Flame Test
- 90°C Dry & Wet
- -40°C Cold Bend, -25°C Cold Impact
- -25°C Installation temp
- Per CEC Part 1, Suitable for use in hazardous locations:
Class 1 — Zone 2
Class 2 — Division 2
- Sunlight Resistant/UV Resistant
- Direct Burial

To Create a Part Number

Add suffix "S" for Overall Foil Shielding

Sample Part Number:

21500S = 600V CSA Tray Control Cable
2-conductor, 14 AWG Bare Copper
Conductor with XLPE Insulation,
PVC Jacket, and Overall Foil Shield

Color Codes

No. of Conductors	Color Combination
2	Black & White
3	Black, Red & Blue
4	Black, Red, Blue & White
5 or more	Black & Number Coded

No. of Conductors	Part Numbers					
	14 AWG (7 Strand)		12 AWG (7 Strand)		10 AWG (7 Strand)	
	600V	1000V	600V	1000V	600V	1000V
2	21500	21300	21550	21350	21600	21400
3	21501	21301	21551	21351	21601	21401
4	21502	21302	21552	21352	21602	21402
5	21503	21303	21553	21353	21603	21403
6	21504	21304	21554	21354	21604	21404
7	21505	21305	21555	21355	21605	21405
8	21506	21306	21556	21356	21606	21406
9	21507	21307	21557	21357	21607	21407
10	21508	21308	21558	21358	21608	21408
11	21509	21309	21559	21359	21609	21409
12	21510	21310	21560	21360	21610	21410
13	21511	21311	21561	21361	21611	21411
14	21512	21312	21562	21362	21612	21412
15	21513	21313	21563	21363	21613	21413
16	21514	21314	21564	21364	21614	21414
17	21515	21315	21565	21365	21615	21415
18	21516	21316	21566	21366	21616	21416
19	21517	21317	21567	21367	21617	21417
20	21518	21318	21568	21368	21618	21418
21	21519	21319	21569	21369	21619	21419
22	21520	21320	21570	21370	21620	21420
23	21521	21321	21571	21371	21621	21421
24	21522	21322	21572	21372	21622	21422
25	21523	21323	21573	21373	21623	21423
26	21524	21324	21574	21374	21624	21424
27	21525	21325	21575	21375	21625	21425
28	21526	21326	21576	21376	21626	21426
29	21527	21327	21577	21377	21627	21427
30	21528	21328	21578	21378	21628	21428
31	21529	21329	21579	21379	21629	21429
32	21530	21330	21580	21380	21630	21430
33	21531	21331	21581	21381	21631	21431
34	21532	21332	21582	21382	21632	21432
35	21533	21333	21583	21383	21633	21433
36	21534	21334	21584	21384	21634	21434
37	21535	21335	21585	21385	21635	21435
38	21536	21336	21586	21386	21636	21436
39	21537	21337	21587	21387	21637	21437
40	21538	21338	21588	21388	21638	21438
41	21539	21339	21589	21389	21639	21439
42	21540	21340	21590	21390	21640	21440
43	21541	21341	21591	21391	21641	21441
44	21542	21342	21592	21392	21642	21442
45	21543	21343	21593	21393	21643	21443
46	21544	21344	21594	21394	21644	21444
47	21545	21345	21595	21395	21645	21445
48	21546	21346	21596	21396	21646	21446
49	21547	21347	21597	21397	21647	21447
50	21548	21348	21598	21398	21648	21448

No. of Cond.	Part Numbers									
	8 AWG (7 Strand)		6 AWG (7 Strand)		4 AWG (7 Strand)		3 AWG (7 Strand)		2 AWG (7 Strand)	
	600V	1000V	600V	1000V	600V	1000V	600V	1000V	600V	1000V
2	21650	21450	21653	21453	21656	21456	21659	21459	21662	21462
3	21651	21451	21654	21454	21657	21457	21660	21460	21663	21463
4	21652	21452	21655	21455	21658	21458	21661	21461	21664	21464

No. of Cond.	Part Numbers									
	1 AWG (19 Strand)		1/0 AWG (19 Strand)		2/0 AWG (19 Strand)		3/0 AWG (19 Strand)		4/0 AWG (19 Strand)	
	600V	1000V	600V	1000V	600V	1000V	600V	1000V	600V	1000V
2	21665	21465	21668	21468	21671	21471	21674	21474	21677	21477
3	21666	21466	21669	21469	21672	21472	21675	21475	21678	21478
4	21667	21467	21670	21470	21673	21473	21676	21476	21679	21479



CSA Control Cable

600V CIC Multi-conductor Cables

Description	Part Number	No. of Cond.	Cable Weight		Insulation Thickness		Jacket Thickness		Nominal OD	
			Lbs./1000 Ft.	kg/km	Inch	mm	Inch	mm	Inch	mm

14 AWG Stranded (7x22) Bare Copper Conductors

Cross-linked Polyethylene Insulation • Black PVC Jacket (Color Code: Black and Numbered)

CSA C22.2#131, Type CIC	22100	2	62	92	.030	.76	.045	1.14	.367	9.32
CSA C22.2#0.3, Clause 4.31 Low Acid Gas FT4 Flame Test	22101	3	81	121	.030	.76	.045	1.14	.388	9.86
	22102	4	101	150	.030	.76	.045	1.14	.423	10.74
	22103	5	122	182	.030	.76	.045	1.14	.462	11.74
	22104	6	143	213	.030	.76	.045	1.14	.504	12.80
	22105	7	160	238	.030	.76	.045	1.14	.504	12.80
	22106	8	197	293	.030	.76	.060	1.52	.576	14.63
	22107	9	220	327	.030	.76	.060	1.52	.618	15.70
	22108	10	226	336	.030	.76	.060	1.52	.669	17.00
	22110	12	279	415	.030	.76	.060	1.52	.689	17.50
	22114	16	357	531	.030	.76	.060	1.52	.764	19.41
	22118	20	467	695	.030	.76	.080	2.03	.886	22.50

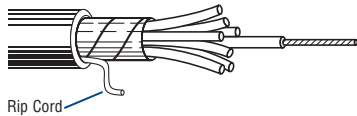

-25°C Installed
-40°C to +90°C (Dry) (75°C Wet)

12 AWG Stranded (7x20) Bare Copper Conductors

Cross-linked Polyethylene Insulation • Black PVC Jacket (Color Code: Black and Numbered)

CSA C22.2#131, Type CIC	22120	2	82	122	.030	.76	.045	1.14	.405	10.29
CSA C22.2#0.3, Clause 4.31 Low Acid Gas FT4 Flame Test	22121	3	109	162	.030	.76	.045	1.14	.429	10.90
	22122	4	140	208	.030	.76	.045	1.14	.469	11.91
	22123	5	170	253	.030	.76	.045	1.14	.515	13.08
	22124	6	214	319	.030	.76	.060	1.52	.591	15.01
	22125	7	240	357	.030	.76	.060	1.52	.591	15.01
	22126	8	270	402	.030	.76	.060	1.52	.639	16.23
	22127	9	302	449	.030	.76	.060	1.52	.687	17.45
	22128	10	336	500	.030	.76	.060	1.52	.745	18.92
	22130	12	390	580	.030	.76	.060	1.52	.768	19.51
	22134	16	584	869	.030	.76	.080	2.03	.893	22.68
	22138	20	655	975	.030	.76	.080	2.03	.992	25.20

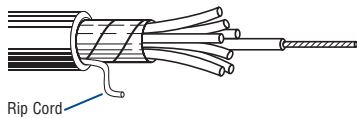

-25°C Installed
-40°C to +90°C (Dry) (75°C Wet)

10 AWG Stranded (7x18) Bare Copper Conductors

Cross-linked Polyethylene Insulation • Black PVC Jacket (Color Code: Black and Numbered)

CSA C22.2#131, Type CIC	22140	2	148	220	.030	.76	.045	1.14	.736	18.69
CSA C22.2#0.3, Clause 4.31 Low Acid Gas FT4 Flame Test	22141	3	189	281	.030	.76	.045	1.14	.763	19.38
	22142	4	248	369	.030	.76	.060	1.52	.839	21.31
	22143	5	293	436	.030	.76	.060	1.52	.891	22.63
	22144	6	338	503	.030	.76	.060	1.52	.944	23.98
	22145	7	378	563	.030	.76	.060	1.52	.944	23.98
	22146	8	424	631	.030	.76	.060	1.52	.999	25.38
	22147	9	469	698	.030	.76	.060	1.52	1.074	27.28
	22148	10	548	816	.030	.76	.080	2.03	1.182	30.02
	22150	12	631	939	.030	.76	.080	2.03	1.209	30.71
	22152	14	717	1067	.030	.76	.080	2.03	1.255	31.88
	22154	16	805	1198	.030	.76	.080	2.03	1.307	33.20

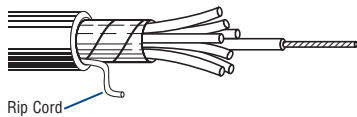

-25°C Installed
-40°C to +90°C (Dry) (75°C Wet)

CSA Control Cable

600V CIC Multi-conductor Cables

Description	Part Number	No. of Cond.	Cable Weight		Insulation Thickness		Jacket Thickness		Nominal OD	
			Lbs./1000 Ft.	kg/km	Inch	mm	Inch	mm	Inch	mm

8 AWG Stranded (7x16) Bare Copper Conductors

Cross-linked Polyethylene Insulation • Black PVC Jacket (Color Code: Black and Numbered)

CSA C22.2#131, Type CIC	22160	2	240	357	.045	1.14	.060	1.52	.863	21.92
CSA C22.2#0.3, Clause 4.31 Low Acid Gas FT4 Flame Test	22161	3	308	458	.045	1.14	.060	1.52	.898	22.81
	22162	4	379	564	.045	1.14	.060	1.52	.957	24.31

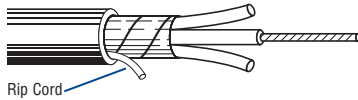

-25°C Installed
-40°C to +90°C (Dry) (75°C Wet)

6 AWG Stranded (7x14) Bare Copper Conductors

Cross-linked Polyethylene Insulation • Black PVC Jacket (Color Code: Black and Numbered)

CSA C22.2#131, Type CIC	22170	2	279	415	.060	1.52	.060	1.52	.711	18.06
CSA C22.2#0.3, Clause 4.31 Low Acid Gas FT4 Flame Test	22171	3	383	570	.060	1.52	.060	1.52	.756	19.20

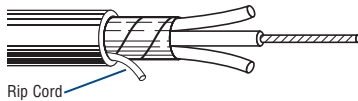

-25°C Installed
-40°C to +90°C (Dry) (75°C Wet)

4 AWG Stranded (7x12) Bare Copper Conductors

Cross-linked Polyethylene Insulation • Black PVC Jacket (Color Code: Black and Numbered)

CSA C22.2#131, Type CIC	22180	2	390	580	.060	1.52	.060	1.52	.800	20.32
CSA C22.2#0.3, Clause 4.31 Low Acid Gas FT4 Flame Test	22181	3	580	863	.060	1.52	.080	2.03	.891	22.63

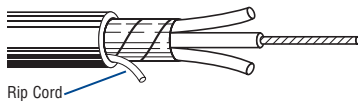

-25°C Installed
-40°C to +90°C (Dry) (75°C Wet)

CSA Control Cable

600V ACIC and Teck90 Cables — Overview

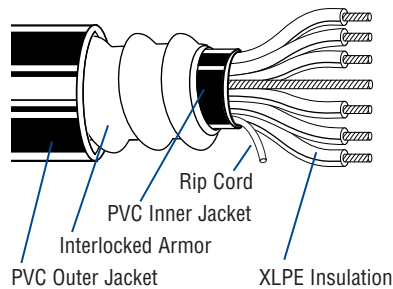

Introduction

Belden® Teck90 and ACIC cables are designed to meet demanding industrial needs by combining rugged durability and corrosion resistance with flexibility and easy handling.

Teck90 and ACIC Cables are available in a wide range of in-stock and custom constructions to meet the needs of pulp and paper, chemical, petroleum and other demanding industrial and resource industry environments. They are ideal for use in wet or dry areas; ventilated, non-ventilated or ladder-type cable troughs; ventilated flexible cableways; and for direct burial.

Belden Teck90 Cable is marked with “FT4,” “HL” designations, and cable constructions are certified to CSA Standard C22.2#131 and C22.2#174 for use in a wide range of hazardous locations. Both inner and outer jackets meet the acid gas evolution requirement of 14% maximum required by CSA Standard C22.2#0.3 Clause 4.31.

Custom cables are available upon request.

Construction

Class B stranded bare copper conductors, cross-link polyethylene insulation, bare copper ground wire, PVC inner jacket, aluminum steel interlocking armor, PVC outer jacket.

- Galvanized steel interlocking armor available as an option.

Voltage Rating

18 to 16 AWG — 600V ACIC

14 to 8 AWG — 600 Volts

14 to 4/0 AWG — 1000 Volts

Temperature Rating

-40°C to 90°C (Dry/Wet)

-25°C installed

Application

Teck90 and ACIC are general-purpose cables used in the pulp and paper, mining, petroleum and chemical industries as well as in commercial buildings.

Teck90 and ACIC may be used under the following conditions:

- Exposed or concealed wiring in dry or wet conditions
- In ventilated, non-ventilated or ladder-type cable trays in dry or wet conditions
- On walls or beams
- Directly buried
- CEC Class I, Division I locations

Minimum Bending Radius

12 times the overall cable diameter

Pulling Tensions

The combined use of Kellems grips and pulling eyes is recommended.

Design Advantages

Insulation Properties

- High tensile strength
- Impact- and crush-resistant
- Heat-resistant
- Excellent elongation
- Moisture-resistant
- Good low temperature properties

Electrical Properties

- High insulation resistance
- Low dielectric loss
- High dielectric strength

Other Features

- Corrosion-resistant
- Versatile and flexible
- Provides cost savings as conduit and ducts are not required
- ACIC has a blue jacket
- Rip cord for inner jacket

Specifications

- CSA Standard C22.2#131
- CSA Standard C22.2#174 “Cables and Cable Glands for Use in Hazardous Locations”
- CSA Standard C22.2#0.3 Clause 4.31 “Low Acid Gas”
- CSA Standard C22.2#0.3 Clause 4.11.4 “Cables with FT4 Marking”

CSA Control Cable

600V ACIC Cables

Description	Part No.	No. of Cond.	Cable Weight		Inner Jacket OD		Armor OD		Outer Jacket		Maximum Pull Tension		Minimum Bend Radius	
			Lbs./1000 Ft.	kg/km	Inch	mm	Inch	mm	Inch	mm	Lbs.	N	Inch	mm

18 AWG Stranded (7x26) Bare Copper Conductors • 18 AWG Bare Copper Ground Wire

Aluminum Interlocked Armor • .030" (.76mm) XLPE Insulation • PVC Inner Jacket • Blue PVC Outer Jacket

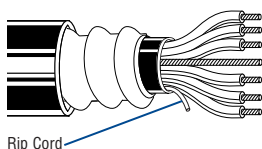
CSA C22.2#239 FT4 Flame Test	29030	2	163	243	.32	8.13	.52	13.21	.62	15.75	44	196	7.4	187.96	
 <p>Rip Cord</p>	29031	3	177	263	.34	8.64	.54	13.72	.64	16.26	66	294	7.6	193.04	
	29032	4	195	290	.37	9.40	.57	14.48	.67	17.02	88	392	8.0	203.20	
	29033	5	219	326	.41	10.41	.61	15.49	.71	18.03	110	490	8.5	215.90	
	29034	6	239	356	.45	11.43	.65	16.51	.75	19.05	132	587	9.0	228.60	
	29035	7	245	365	.45	11.43	.65	16.51	.75	19.05	154	685	9.0	228.60	
	29036	8	266	396	.48	12.19	.68	17.27	.78	19.81	176	783	9.3	236.22	
	29038	10	331	493	.56	14.22	.76	19.30	.87	22.10	220	979	10.6	269.24	
	29040	12	353	525	.62	15.75	.82	20.83	.93	23.62	264	1175	11.1	281.94	
	29043	15	401	597	.65	16.51	.85	21.59	.96	24.38	330	1469	11.5	292.10	
	29048	20	466	694	.73	18.54	.93	23.62	1.04	26.42	440	1958	12.4	314.96	
	29053	25	589	877	.79	20.07	1.05	26.67	1.16	29.46	550	2448	13.9	353.06	
	29058	30	698	1039	.88	22.35	1.14	28.96	1.25	31.75	660	2937	15.0	381.00	
	29068	40	827	1231	.97	24.64	1.23	31.24	1.35	34.29	880	3916	16.2	411.48	
	HAZ LOC CSA C22.2#0.3 Clause 4.31 Low Acid Gas	29078	50	965	1436	1.09	27.69	1.35	34.29	1.47	37.34	1100	4895	17.6	447.04

16 AWG Stranded (7x24) Bare Copper Conductors • 16 AWG Bare Copper Ground Wire

Aluminum Interlocked Armor • .030" (.76mm) XLPE Insulation • PVC Inner Jacket • Blue PVC Outer Jacket

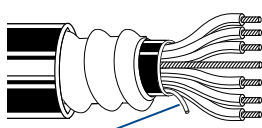
CSA C22.2#239 FT4 Flame Test	29017	2	202	301	.34	8.64	.54	13.72	.65	16.51	70	312	7.7	195.58
 <p>Rip Cord</p>	29004	3	221	329	.36	9.14	.56	14.22	.66	16.76	105	467	7.9	200.66
	29018	4	242	360	.39	9.91	.59	14.99	.70	17.78	140	623	8.3	210.82
	29019	5	264	393	.42	10.67	.62	15.75	.73	18.54	175	779	8.6	218.44
	29005	6	292	435	.46	11.68	.66	16.76	.77	19.56	210	935	9.1	231.14
	29020	7	314	467	.47	11.94	.67	17.02	.77	19.56	245	1090	9.2	233.68
	29021	8	364	542	.50	12.70	.70	17.78	.80	20.32	280	1246	9.6	243.84
	29022	10	412	613	.61	15.49	.81	20.57	.92	23.37	350	1558	10.9	276.86
	29006	12	441	656	.63	16.00	.83	21.08	.94	23.88	420	1869	11.2	284.48
	29023	15	502	748	.68	17.27	.88	22.35	1.00	25.40	525	2336	11.9	302.26
	29007	20	636	947	.77	19.56	1.03	26.16	1.13	28.70	700	3115	13.7	347.98
	29024	25	845	1258	.89	22.61	1.15	29.21	1.26	32.00	875	3894	15.1	383.54
	29008	30	922	1372	.94	23.88	1.20	30.48	1.30	33.02	1050	4673	15.8	401.32
	29009	40	1109	1650	1.06	26.92	1.32	33.53	1.41	35.81	1400	6230	17.3	439.42
	29016	50	1306	1944	1.19	30.23	1.45	36.83	1.54	39.12	1750	7788	18.8	477.52
	HAZ LOC CSA C22.2#0.3 Clause 4.31 Low Acid Gas	29025	60	1390	2070	1.27	32.26	1.53	38.86	1.66	42.16	2100	9345	19.9

XLPE = Cross-linked Polyethylene

Color Code: #1 conductor is white; remaining conductors are black with number coding. Other color codes available upon request.

CSA Control Cable

600V Teck90 Cables

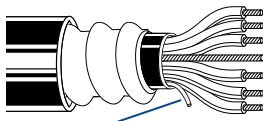
Description	Part No.	No. of Cond.	Cable Weight		Inner Jacket OD		Armor OD		Outer Jacket		Maximum Pull Tension		Minimum Bend Radius	
			Lbs./1000 Ft.	kg/km	Inch	mm	Inch	mm	Inch	mm	Lbs.	N	Inch	mm
14 AWG Stranded (7x22) Bare Copper Conductors • 14 AWG Bare Copper Ground Wire														
Aluminum Interlocked Armor • .030" (.76mm) XLPE Insulation • PVC Inner Jacket • Black PVC Outer Jacket														
CSA C22.2#131 FT4 Flame Test 	C5500	2	198	296	.36	9.14	.56	14.22	.66	16.76	108	481	7.8	198.12
	C5501	3	222	331	.39	9.91	.58	14.73	.66	16.76	162	721	8.2	208.28
	C5502	4	251	375	.42	10.67	.62	15.75	.71	18.03	216	961	8.5	215.90
	C5503	5	284	424	.47	11.94	.66	16.76	.74	18.80	270	1202	9.0	228.60
	C5504	6	317	473	.51	12.95	.70	17.78	.78	19.81	324	1442	9.5	241.30
	C5505	7	331	494	.51	12.95	.70	17.78	.78	19.81	378	1682	9.5	241.30
	C5506	8	414	618	.58	14.73	.77	19.56	.86	21.84	432	1922	10.4	264.16
	C5508	10	510	761	.67	17.02	.93	23.62	.95	24.13	540	2403	12.3	312.42
	C5510	12	551	822	.69	17.53	.95	24.13	.97	24.64	648	2884	12.6	320.04
	C5513	15	636	949	.77	19.56	1.03	26.16	1.11	28.19	810	3605	14.1	358.14
	C5518	20	810	1209	.90	22.86	1.16	29.46	1.24	31.50	1080	4806	15.1	383.54
	C5523	25	948	1415	.90	22.86	1.24	31.50	1.33	33.78	1350	6008	16.1	408.94
	C5528	30	1047	1563	1.05	26.67	1.30	33.02	1.40	35.56	1620	7209	16.8	426.72
	C5529	40	1310	1955	1.20	30.48	1.42	36.07	1.51	38.35	2160	9612	18.3	464.82
	HAZ LOC CSA C22.2#0.3 Clause 4.31 Low Acid Gas C6064	50	1620	2418	1.35	34.29	1.60	40.64	1.66	42.16	2700	12015	20.5	520.70

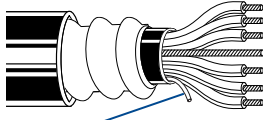
12 AWG Stranded (7x20) Bare Copper Conductors • 14 AWG Bare Copper Ground Wire														
Aluminum Interlocked Armor • .030" (.76mm) XLPE Insulation • PVC Inner Jacket • Black PVC Outer Jacket														
CSA C22.2#131 FT4 Flame Test 	C5530	2	225	336	.41	10.41	.60	15.24	.69	17.53	172	765	8.3	210.82
	C5531	3	261	390	.43	10.92	.62	15.75	.70	17.78	258	1148	8.6	218.44
	C5532	4	301	449	.47	11.94	.66	16.76	.73	18.54	344	1531	9.1	231.14
	C5533	5	348	519	.52	13.21	.71	18.03	.78	19.81	430	1914	9.1	231.14
	C5534	6	435	649	.59	14.99	.78	19.81	.86	21.84	516	2296	10.5	266.70
	C5535	7	450	672	.59	14.99	.78	19.81	.86	21.84	602	2679	10.5	266.70
	C5536	8	506	755	.64	16.26	.83	21.08	.92	23.37	688	3062	11.1	281.94
	C5538	10	633	945	.75	19.05	1.01	25.65	1.02	25.91	860	3827	13.3	337.82
	C5540	12	696	1039	.77	19.56	1.03	26.16	1.12	28.45	1032	4592	13.5	342.90
	C5543	15	823	1228	.90	22.86	1.16	29.46	1.24	31.50	1290	5741	15.1	383.54
	C5548	20	1035	1545	.99	25.15	1.25	31.75	1.34	34.04	1720	7654	16.5	419.10
	C5553	25	1230	1836	1.10	27.94	1.36	34.54	1.45	36.83	2150	9568	17.6	447.04
	HAZ LOC CSA C22.2#0.3 Clause 4.31 Low Acid Gas C5558	30	1390	2075	1.20	30.48	1.46	37.08	1.51	38.35	2580	11481	17.6	447.04

XLPE = Cross-linked Polyethylene

Color Code: 2 conductors — Black, White (If required, a Red conductor can be used in place of White.)
 3 conductors — Black, Red, Blue (If required, a White conductor can be used in place of Blue.)
 4 conductors — Black, Red, Blue, White
 5 or more conductors — Black and numbered

CSA Control Cable

600V Teck90 Cables

Description	Part No.	No. of Cond.	Cable Weight		Inner Jacket OD		Armor OD		Outer Jacket		Maximum Pull Tension		Minimum Bend Radius	
			Lbs./1000 Ft.	kg/km	Inch	mm	Inch	mm	Inch	mm	Lbs.	N	Inch	mm

10 AWG Stranded (7x18) Bare Copper Conductors • 12 AWG Bare Copper Ground Wire

Aluminum Interlocked Armor • .030" (.76mm) XLPE Insulation • PVC Inner Jacket • Black PVC Outer Jacket

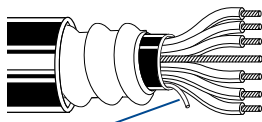
CSA C22.2#131 FT4 Flame Test  Rip Cord	C5560	2	278	415	.48	12.19	.66	16.76	.72	18.29	296	1317	8.9	226.06
	C5561	3	327	488	.50	12.70	.70	17.78	.75	19.05	444	1976	9.2	233.68
	C5562	4	405	604	.57	14.48	.77	19.56	.79	20.07	592	2634	10.1	256.64
	C5563	5	487	727	.63	16.00	.83	21.08	.93	23.62	740	3293	11.5	292.10
	C5564	6	556	830	.68	17.27	.88	22.35	.93	23.62	888	3952	11.5	292.10
	C5565	7	627	936	.69	17.53	.89	22.61	.99	25.15	1036	4610	11.8	299.72
	C5566	8	739	1103	.74	18.80	.94	23.88	1.00	25.40	1184	5269	12.4	314.96
	C5568	10	964	1439	.84	21.34	1.10	27.94	1.24	31.50	1480	6586	14.4	365.76
	C5570	12	1067	1593	.93	23.62	1.19	30.23	1.26	32.00	1776	7903	15.6	396.24
	C5573	15	1297	1936	.99	25.15	1.25	31.75	1.37	34.80	2220	9879	16.3	414.02
HAZ LOC CSA C22.2#0.3 Clause 4.31 Low Acid Gas	C5578	20	1546	2307	1.13	28.70	1.39	35.31	1.47	37.34	2960	13172	16.9	429.26
	C5579	25	1802	2690	1.26	32.00	1.52	38.61	1.60	40.64	3700	16465	19.7	500.38
	C5580	30	2142	3197	1.34	34.04	1.60	40.64	1.66	42.16	4440	19758	20.6	523.24

8 AWG Stranded (7x16) Bare Copper Conductors • 10 AWG Bare Copper Ground Wire

Aluminum Interlocked Armor • .045" (1.14mm) XLPE Insulation • PVC Inner Jacket • Black PVC Outer Jacket

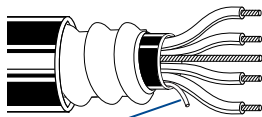
CSA C22.2#131 FT4 Flame Test  Rip Cord	C5583	2	407	607	.59	14.99	.78	19.81	.86	21.84	384	1709	10.6	269.24
	C5581	3	471	703	.63	16.00	.83	21.08	.90	22.86	576	2563	10.8	274.32
	C5582	4	606	904	.69	17.53	.89	22.61	.97	24.64	768	3418	12.5	317.50
Dual Rated 600V, 1000V HAZ LOC CSA C22.2#0.3 Clause 4.31 Low Acid Gas														

XLPE = Cross-linked Polyethylene

Color Code: 2 conductors — Black, White (if required, a Red conductor can be used in place of White.)
 3 conductors — Black, Red, Blue (if required, a White conductor can be used in place of Blue.)
 4 conductors — Black, Red, Blue, White
 5 or more conductors — Black and numbered

CSA Control Cable

600V Teck90 Cables

Description	Part No.	No. of Cond.	Cable Weight		Inner Jacket OD		Armor OD		Outer Jacket		Maximum Pull Tension		Minimum Bend Radius	
			Lbs./1000 Ft.	kg/km	Inch	mm	Inch	mm	Inch	mm	Lbs.	N	Inch	mm

Composite 14 AWG Stranded (7x22) and 12 AWG Stranded (7x20) Bare Copper Conductors • 14 AWG Bare Copper Ground Wire

Aluminum Interlocked Armor • .031" (.79mm) XLPE Insulation • PVC Inner Jacket • Black PVC Outer Jacket

CSA C22.2#131 FT4 Flame Test	6054	3c/14 3c/12	369	549	.560	14.22	.75	19.05	.89	22.61	424	1886	8.4	213.36
---------------------------------	-------------	----------------	-----	-----	------	-------	-----	-------	-----	-------	-----	------	-----	--------

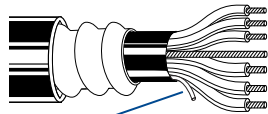

Rip Cord

HAZ LOC
CSA C22.2#0.3 Clause 4.31 Low Acid Gas

Composite 14 AWG Stranded (7x22) and 10 AWG Stranded (7x18) Bare Copper Conductors • 12 AWG Bare Copper Ground Wire

Aluminum Interlocked Armor • .031" (.79mm) XLPE Insulation • PVC Inner Jacket • Black PVC Outer Jacket

CSA C22.2#131 FT4 Flame Test	6051	3c/14 3c/10	432	643	.600	15.24	.82	20.83	.92	23.37	608	2705	9.0	228.60
---------------------------------	-------------	----------------	-----	-----	------	-------	-----	-------	-----	-------	-----	------	-----	--------

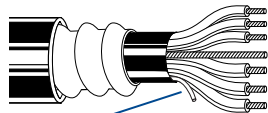

Rip Cord

HAZ LOC
CSA C22.2#0.3 Clause 4.31 Low Acid Gas

Composite 14 AWG Stranded (7x22) and 8 AWG Stranded (7x16) Bare Copper Conductors • 10 AWG Bare Copper Ground Wire

Aluminum Interlocked Armor • .046" (1.17mm) XLPE Insulation • PVC Inner Jacket • Black PVC Outer Jacket

CSA C22.2#131 FT4 Flame Test	6059	3c/14 3c/8	608	905	.700	17.78	.89	22.51	.98	24.92	1160	5160	9.8	248.92
---------------------------------	-------------	---------------	-----	-----	------	-------	-----	-------	-----	-------	------	------	-----	--------

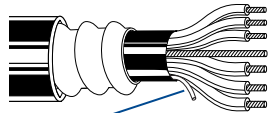

Rip Cord

HAZ LOC
CSA C22.2#0.3 Clause 4.31 Low Acid Gas

Composite 14 AWG Stranded (7x22) and 6 AWG Stranded (7x14) Bare Copper Conductors • 8 AWG Bare Copper Ground Wire

Aluminum Interlocked Armor • .061" (1.55mm) XLPE Insulation • PVC Inner Jacket • Black PVC Outer Jacket

CSA C22.2#131 FT4 Flame Test	6060	3c/14 3c/6	849	1264	.810	20.57	1.06	27.00	1.16	29.41	1700	7562	11.6	294.64
---------------------------------	-------------	---------------	-----	------	------	-------	------	-------	------	-------	------	------	------	--------

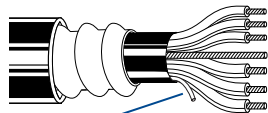

Rip Cord

HAZ LOC
CSA C22.2#0.3 Clause 4.31 Low Acid Gas

XLPE = Cross-linked Polyethylene

Color Code: 2 conductors — Black, White (If required, a Red conductor can be used in place of White.)
3 conductors — Black, Red, Blue (If required, a White conductor can be used in place of Blue.)
4 conductors — Black, Red, Blue, White
5 or more conductors — Black and numbered

CSA Control Cable

1000V Teck90 Cables

Description	Part No.	No. of Cond.	Cable Weight		Inner Jacket OD		Armor OD		Outer Jacket		Maximum Pull Tension		Minimum Bend Radius	
			Lbs./1000 Ft.	kg/km	Inch	mm	Inch	mm	Inch	mm	Lbs.	N	Inch	mm

14 AWG Stranded (7x22) Bare Copper Conductors • 14 AWG Bare Copper Ground Wire

Aluminum Interlocked Armor • .045" (1.14mm) XLPE Insulation • PVC Inner Jacket • Black PVC Outer Jacket

CSA C22.2#131	C5701	3	251	374	.47	11.94	.67	17.02	.73	18.54	162	721	9.2	233.68
FT4 Flame Test	C5702	4	301	448	.51	12.95	.71	18.03	.81	20.57	216	961	9.7	246.38

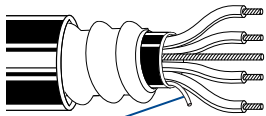

Rip Cord

HAZ LOC
CSA C22.2#0.3 Clause 4.31 Low Acid Gas

12 AWG Stranded (7x20) Bare Copper Conductors • 14 AWG Bare Copper Ground Wire

Aluminum Interlocked Armor • .045" (1.14mm) XLPE Insulation • PVC Inner Jacket • Black PVC Outer Jacket

CSA C22.2#131	C5730	2	253	377	.48	12.19	.68	17.27	.74	18.80	172	765	9.3	236.22
FT4 Flame Test	C5731	3	291	433	.51	12.95	.71	18.03	.76	19.30	258	1148	9.7	246.38
	C5732	4	368	548	.59	14.99	.75	19.05	.85	21.59	344	1531	10.8	274.32

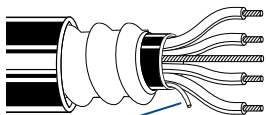

Rip Cord

HAZ LOC
CSA C22.2#0.3 Clause 4.31 Low Acid Gas

10 AWG Stranded (7x18) Bare Copper Conductors • 12 AWG Bare Copper Ground Wire

Aluminum Interlocked Armor • .045" (1.14mm) XLPE Insulation • PVC Inner Jacket • Black PVC Outer Jacket

CSA C22.2#131	C5760	2	285	424	.56	14.22	.79	19.99	.70	17.71	296	1317	10.3	261.62
FT4 Flame Test	C5761	3	389	581	.59	14.99	.79	20.07	.85	21.59	444	1976	10.3	261.62
	C5762	4	460	687	.65	16.51	.85	21.59	.90	22.86	592	2634	11.5	292.10

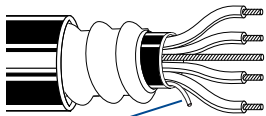

Rip Cord

HAZ LOC
CSA C22.2#0.3 Clause 4.31 Low Acid Gas

8 AWG Stranded (7x16) Bare Copper Conductors • 10 AWG Bare Copper Ground Wire

Aluminum Interlocked Armor • .045" (1.14mm) XLPE Insulation • PVC Inner Jacket • Black PVC Outer Jacket

CSA C22.2#131	C5583	2	407	607	.59	14.99	.78	19.81	.86	21.84	384	1709	10.6	269.24
FT4 Flame Test	C5581	3	471	703	.63	16.00	.83	21.08	.90	22.86	576	2563	10.8	274.32
	C5582	4	606	905	.69	17.53	.89	22.61	.97	24.64	768	3418	12.5	317.50

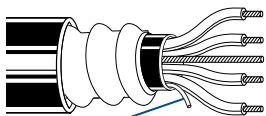

Rip Cord

Dual Rated 600V, 1000V
HAZ LOC
CSA C22.2#0.3 Clause 4.31 Low Acid Gas

XLPE = Cross-linked Polyethylene

Color Code: 2 conductors — Black, White (If required, a Red conductor can be used in place of White.)
3 conductors — Black, Red, Blue (If required, a White conductor can be used in place of Blue.)
4 conductors — Black, Red, Blue, White
5 or more conductors — Black and numbered

CSA Control Cable

1000V Teck90 Cables

Description	Part No.	No. of Cond.	Cable Weight		Inner Jacket OD		Armor OD		Outer Jacket		Maximum Pull Tension		Minimum Bend Radius	
			Lbs./1000 Ft.	kg/km	Inch	mm	Inch	mm	Inch	mm	Lbs.	N	Inch	mm

6 AWG Stranded (7x14) Bare Copper Conductors • 8 AWG Bare Copper Ground Wire

Aluminum Interlocked Armor • .060" (1.53mm) XLPE Insulation • PVC Inner Jacket • Black PVC Outer Jacket

CSA C22.2#131 FT4 Flame Test	C5590	2	567	844	.73	18.54	.99	25.15	1.10	27.94	610	2713	12.8	325.12
	C5591	3	685	1019	.78	19.81	1.04	26.42	1.15	29.21	915	4072	13.4	340.36
	C5592	4	927	1380	.89	22.61	1.15	29.21	1.24	31.50	1220	5429	14.9	378.46

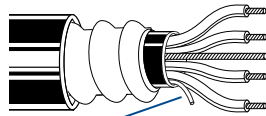

Rip Cord

HAZ LOC
CSA C22.2#0.3 Clause 4.31 Low Acid Gas

4 AWG Stranded (7x12) Bare Copper Conductors • 8 AWG Bare Copper Ground Wire

Aluminum Interlocked Armor • .060" (1.53mm) XLPE Insulation • PVC Inner Jacket • Black PVC Outer Jacket

CSA C22.2#131 FT4 Flame Test	C5601	3	961	1430	.91	23.11	1.17	29.72	1.23	31.24	1455	6475	15.2	386.08
	C5602	4	1202	1794	.91	23.11	1.25	31.75	1.33	33.78	1940	8633	16.2	411.48

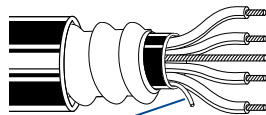

Rip Cord

HAZ LOC
CSA C22.2#0.3 Clause 4.31 Low Acid Gas

3 AWG Stranded (7x11) Bare Copper Conductors • 6 AWG Bare Copper Ground Wire

Aluminum Interlocked Armor • .060" (1.53mm) XLPE Insulation • PVC Inner Jacket • Black PVC Outer Jacket

CSA C22.2#131 FT4 Flame Test	C5611	3	1126	1681	.97	24.64	1.23	31.24	1.30	33.02	1836	8170	15.8	401.32
---------------------------------	--------------	---	------	------	-----	-------	------	-------	------	-------	------	------	------	--------

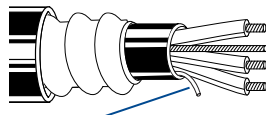

Rip Cord

HAZ LOC
CSA C22.2#0.3 Clause 4.31 Low Acid Gas

2 AWG Stranded (7x10) Bare Copper Conductors • 6 AWG Bare Copper Ground Wire

Aluminum Interlocked Armor • .060" (1.53mm) XLPE Insulation • PVC Inner Jacket • Black PVC Outer Jacket

CSA C22.2#131 FT4 Flame Test	C5621	3	1291	1927	1.02	25.91	1.28	32.51	1.37	34.80	2316	10302	16.5	419.10
	C5622	4	1691	2524	1.12	28.45	1.38	35.05	1.48	37.59	3088	13736	17.7	449.58

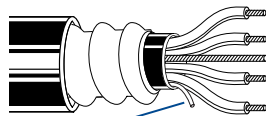

Rip Cord

HAZ LOC
CSA C22.2#0.3 Clause 4.31 Low Acid Gas

XLPE = Cross-linked Polyethylene

Color Code: 2 conductors — Black, White (If required, a Red conductor can be used in place of White.)
3 conductors — Black, Red, Blue (If required, a White conductor can be used in place of Blue.)
4 conductors — Black, Red, Blue, White

CSA Control Cable

1000V Teck90 Cables

Description	Part No.	No. of Cond.	Cable Weight		Inner Jacket OD		Armor OD		Outer Jacket		Maximum Pull Tension		Minimum Bend Radius	
			Lbs./1000 Ft.	kg/km	Inch	mm	Inch	mm	Inch	mm	Lbs.	N	Inch	mm

1 AWG Stranded (19x14) Bare Copper Conductors • 6 AWG Bare Copper Ground Wire

Aluminum Interlocked Armor • .080" (2.03mm) XLPE Insulation • PVC Inner Jacket • Black PVC Outer Jacket

CSA C22.2#131	C5625	3	1620	2411	1.25	31.75	1.51	38.35	1.59	40.39	1980	8807	19.1	485.14
FT4 Flame Test	C5626	4	2173	3234	1.34	34.04	1.57	39.88	1.68	42.67	2680	11921	20.2	513.08

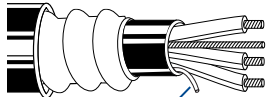

HAZ LOC
CSA C22.2#0.3 Clause 4.31 Low Acid Gas

1/0 AWG Stranded (19x12) Bare Copper Conductors • 6 AWG Bare Copper Ground Wire

Aluminum Interlocked Armor • .080" (2.03mm) XLPE Insulation • PVC Inner Jacket • Black PVC Outer Jacket

CSA C22.2#131	C5627	3	1912	2854	1.34	34.04	1.60	40.64	1.67	42.42	3582	15940	20.0	508.0
FT4 Flame Test	6164	4	2514	3742	1.44	36.58	1.67	42.42	1.78	45.21	4700	20906	21.4	543.56

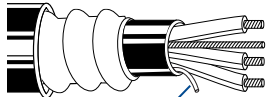

HAZ LOC
CSA C22.2#0.3 Clause 4.31 Low Acid Gas

2/0 AWG Stranded (19x11) Bare Copper Conductors • 6 AWG Bare Copper Ground Wire

Aluminum Interlocked Armor • .080" (2.03mm) XLPE Insulation • PVC Inner Jacket • Black PVC Outer Jacket

CSA C22.2#131	C5635	3	2300	3423	1.40	35.56	1.63	41.40	1.74	44.20	4200	12010	20.9	530.86
FT4 Flame Test	6157	4	3039	4523	1.55	39.37	1.84	46.74	1.95	49.53	5500	24465	23.4	594.36

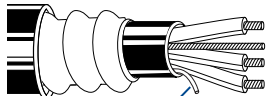

HAZ LOC
CSA C22.2#0.3 Clause 4.31 Low Acid Gas

3/0 AWG Stranded (19x10) Bare Copper Conductors • 4 AWG Bare Copper Ground Wire

Aluminum Interlocked Armor • .080" (2.03mm) XLPE Insulation • PVC Inner Jacket • Black PVC Outer Jacket

CSA C22.2#131	6163	3	2905	4324	1.51	38.10	1.80	45.72	1.91	48.26	5020	11121	22.9	579.12
FT4 Flame Test	6179	4	3700	5506	1.67	42.42	1.96	49.78	2.07	52.58	6500	28913	24.8	629.92

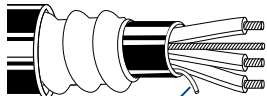

HAZ LOC
CSA C22.2#0.3 Clause 4.31 Low Acid Gas

4/0 AWG Stranded (19x9.5) Bare Copper Conductors • 4 AWG Bare Copper Ground Wire

Aluminum Interlocked Armor • .080" (2.03mm) XLPE Insulation • PVC Inner Jacket • Black PVC Outer Jacket

CSA C22.2#131	6193	3	3450	5134	1.63	41.40	1.92	48.77	2.03	51.56	6650	29580	24.4	619.76
FT4 Flame Test														

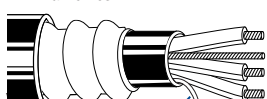

HAZ LOC
CSA C22.2#0.3 Clause 4.31 Low Acid Gas

XLPE = Cross-linked Polyethylene

Color Code: 3 conductors — Black, Red, Blue (If required, a White conductor can be used in place of Blue.)
4 conductors — Black, Red, Blue, White



CSA Control Cable

1000V Variable Frequency Drive Cable

Cable Specifications

- CSA C22.2 #38 Type TC
- CSA C22.2 #230 Type TC
- CSA FT4 70,000 BTU Flame Test
- 90°C Dry and Wet
- -40°C Cold Bend, -25°C Cold Impact
- -25°C Installation temp
- Per CEC Part 1, Suitable for Use in Hazardous Locations:
Class 1 — Zone 2
Class 2 — Division 2
- Sunlight Resistant/UV Resistant
- Direct Burial

14 to 2 AWG with Foil/Braid Shield

Belden's classic line of VFD cables, with foil/braid shield, is offered in 14 to 2 AWG, and continues to be the highest-performing solution in the market. The oversized XLPE insulation provides the lowest capacitance available in a VFD cable. Its highly effective dual shielding provides the lowest resistance to ground path, which improves common mode current containment. Included are a full-size, insulated green ground wire with a yellow stripe, as well as a drain wire for ease of installation and termination. The 85% braid coverage offers optimum EMI low frequency noise protection, while the 100% aluminum/Mylar tape offers RFI high frequency noise protection. Cables are round and smooth for proper sealing of glands and molding applications.

Large AWG (1 to 4/0) with Copper Tape Shield, Symmetrical Design

Belden's symmetrical design combines the benefits of our classic line of VFD cables, with additional features for use on larger, more powerful AC motor drives. Its highly effective shielding provides a low resistance ground path, which improves common mode current containment. The spirally applied dual copper tapes provide improved flexibility and EMI/RFI noise protection. Three symmetrical bare ground wires provide a balanced ground system. This reduces the likelihood of premature motor bearing or motor insulation failure.

Description	Part Number	AWG	Stranding	Shield
-------------	-------------	-----	-----------	--------

14 to 2 AWG (3) Stranded Bare Copper Circuit Conductors + (1) Full-sized PVC Insulated Ground • Overall Beldfoil® (100% Coverage) + TC Braid Shield (85% Coverage) • Full Size TC Drain Wire (ICEA Method 4 Color Code: Black and Numbered, Green/Yellow Ground)

XLPE Insulation • Black Sunlight- and Oil-resistant PVC Jacket

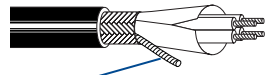
1000V CSA TC	29550	14	7	Beldfoil (100% Coverage) + TC Braid (85% Coverage)
FT4	29551	12	7	
RW90 Circuit Conductors	29552	10	7	
	29553	8	7	
	29554	6	7	
	29555	4	7	
	29556	2	7	

1 to 4/0 AWG (3) Stranded Bare Copper Circuit Conductors + (3) Symmetrical Bare Copper Grounds • (2) Spiral Copper Tape Shields

XLPE Insulation • Black Sunlight- and Oil-resistant PVC Jacket

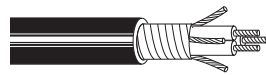
1000V CSA TC	29557	1	19	(2) Spiral Copper Tapes
FT4	29558	1/0	19	
XHHW-2 Circuit Conductors	29559	2/0	19	
	29560	3/0	19	
	29561	4/0	19	

Products listed are subject to minimum order quantities.

Technical Information

Gland Information for Armored Cables

Thomas and Betts

Part No.	Hub Size NPT	Range Over Jacket			
		Minimum		Maximum	
		Inch	mm	Inch	mm
ST050-462	1/2	.525	13.34	.650	16.51
ST050-464	1/2	.600	15.24	.760	19.30
ST050-465	1/2	.725	18.42	.885	22.48
ST050-466	1/2	.825	20.96	.985	25.02
ST075-467	3/4	.880	22.35	1.065	27.05
ST075-468	3/4	1.025	26.04	1.205	30.61
ST100-469	1	1.187	30.15	1.375	34.93
ST125-470	1-1/4	1.350	34.29	1.625	41.28
ST125-550	1-1/4	1.500	38.10	1.625	41.28
ST125-471	1-1/4	1.600	40.64	1.875	47.63
ST150-472	1-1/2	1.700	43.18	1.965	49.91
ST150-473	1-1/2	1.900	48.26	2.187	55.55
ST200-551	2	1.900	48.26	2.187	55.55
ST200-474	2	2.100	53.34	2.375	60.33
ST200-475	2	2.300	58.42	2.565	65.15
ST200-476	2	2.500	63.50	2.750	69.85
ST250-477	2-1/2	2.380	60.45	2.640	67.06
ST250-478	2-1/2	2.580	65.53	2.840	72.14
ST300-479	3	2.790	70.87	3.060	77.72
ST300-480	3	3.000	76.20	3.270	83.06
ST300-481	3	3.210	81.53	3.480	88.39
ST350-482	3-1/2	3.420	86.67	3.690	93.73
ST350-483	3-1/2	3.610	91.69	3.870	98.30
ST400-484	4	3.810	96.77	4.030	102.36
ST400-485	4	3.965	100.71	4.185	106.30
ST400-486	4	4.120	104.65	4.340	110.24

Crouse Hinds

NPT Thread Size	Armor OD Range (Inch)	Non-Hazardous Part No.	Hazardous Part No.
1/2	.440 to .650	TMC165	TMCX165*
3/4	.600 to .850	TMC285	TMCX285*
1	.800 to 1.120	TMC3112	TMCX3112*
1-1/4	1.100 to 1.400	TMC4140	TMCX4140*
1-1/2	1.330 to 1.610	TMC5161	TMCX5161*
2	1.570 to 2.060	TMC6206	TMCX6206*
2-1/2	1.930 to 2.470	TMC7247	TMCX7247*
3	2.450 to 3.020	TMC8302	TMCX8302
3-1/2	2.950 to 3.520	TMC9352	TMCX9352
4	3.500 to 4.020	TMC10402	TMCX10402

* TMCX Catalog numbers listed are suitable for use with Type TC tray cable in hazardous locations when installed in accordance with NEC Articles 501-5(e) and 502-5. TMCX series is not suitable for use in Class III locations when used with tray cable.

Hawke

Hawke Size Ref.	Standard Seal 1348 Diameter				Alternative Seal 1498 Diameter				NPT Size
	Minimum		Maximum		Minimum		Maximum		
	Inch	mm	Inch	mm	Inch	mm	Inch	mm	
711-A	.590	14.99	.820	20.83	.470	11.94	.610	15.49	1/2
711-B	.790	20.07	.060	26.92	.630	16.00	.840	21.34	3/4
711-C	.930	23.62	1.310	33.27	.830	21.08	1.090	27.69	1
711-C2	1.260	32.00	1.690	42.93	1.100	27.94	1.340	34.04	1-1/4
711-D	1.690	42.93	2.060	52.32	1.300	33.02	1.610	40.89	2
711-E	2.050	52.07	2.560	65.02	1.810	45.97	2.160	54.86	2-1/2
711-F	2.560	65.02	3.070	77.98	2.240	56.90	2.640	67.06	3
711-H	2.990	75.95	3.520	89.41	Special Order				3-1/2
711-J	3.500	88.90	4.110	104.39	Special Order				4

Adalet — PLM

Part No.**	Diameter Over Jacket				Conduit Size
	Minimum		Maximum		
	Inch	mm	Inch	mm	
PS/PSX 45-05	.350	8.89	.450	11.43	1/2
PS/PSX 55-05	.450	11.43	.550	13.97	1/2
PS/PSX 65-05	.550	13.97	.650	16.51	1/2
PS/PSX 75-05	.650	16.51	.750	19.05	1/2
PS/PSX 85-05	.750	19.05	.850	21.59	1/2
PS/PSX 95-05	.850	21.59	.950	24.13	1/2
PS/PSX 99-07	.850	21.59	.990	25.15	3/4
PS/PSX 107-07	.920	23.37	1.070	27.18	3/4
PS/PSX 113-07	.980	24.89	1.130	28.70	3/4
PS/PSX 121-07	1.070	27.18	1.210	30.73	3/4
PS/PSX 112-10	1.000	25.40	1.120	28.45	1
PS/PSX 125-10	1.120	28.45	1.250	31.25	1
PS/PSX 138-10	1.220	30.99	1.380	35.05	1
PS/PSX 138-12	1.280	32.51	1.380	35.05	1-1/4
PS/PSX 156-12	1.380	35.05	1.560	39.62	1-1/4
PS/PSX 174-12	1.560	39.62	1.740	44.20	1-1/4
PS/PSX 188-12	1.740	44.20	1.880	47.75	1-1/4
PS/PSX 174-15	1.600	40.64	1.740	44.20	1-1/2
PS/PSX 188-15	1.740	44.20	1.880	47.75	1-1/2
PS/PSX 200-15	1.880	47.75	2.000	50.80	1-1/2
PS/PSX 218-15	2.000	50.80	2.180	55.37	1-1/2
PS/PSX 219-20	2.050	52.07	2.190	55.63	2
PS/PSX 236-20	2.190	55.63	2.360	59.94	2
PS/PSX 247-20	2.350	59.69	2.470	62.74	2
PS/PSX 261-20	2.470	62.74	2.610	66.29	2
PS/PSX 263-25	2.460	62.48	2.630	66.80	2-1/2
PS/PSX 280-25	2.620	66.55	2.800	71.12	2-1/2
PS/PSX 296-25	2.800	71.12	2.960	75.18	2-1/2
PS/PSX 297-30	2.800	71.12	2.970	75.44	3
PS/PSX 311-30	2.950	74.93	3.110	78.99	3
PS/PSX 327-30	3.100	78.74	3.270	83.06	3
PS/PSX 343-30	3.260	82.80	3.430	87.12	3
PS/PSX 359-30	3.420	86.87	3.590	91.19	3
PS/PSX 375-35	3.520	89.41	3.750	95.25	3-1/2
PS/PSX 392-35	3.750	95.25	3.920	99.57	3-1/2
PS/PSX 412-35	3.900	99.06	4.120	104.65	3-1/2
PS/PSX 423-40	4.050	102.87	4.230	107.44	4
PS/PSX 437-40	4.200	106.68	4.370	111.00	4
PS/PSX 451-40	4.340	110.24	4.510	114.55	4
PS/PSX 462-40	4.430	112.52	4.620	117.35	4

** Use PS for non-hazardous locations and PSX for hazardous locations.



Technical Information

LSZH Jacketed Cables and Hazardous Locations Reference

Approvals and Standards/Performance Data for Low-Smoke, Zero-Halogen Jacketed Cable

XLPE Insulation	
Physical: (per UL-44)	
Tensile (min)	1500 psi
Elongation (min)	150%
Deformation (max)	3.35
LOI	27

Haloarrest® Jacket	
Physical	
Tensile (min)	1500 psi
Elongation (min)	100%
Tear resistance	74 lbs/inch
LOI	38
Halogen Content	
IEC 754-1	0%
BS6425	0%
MIL-C-24643	<0.2%
NBS Smoke Chamber (.100" wall)	
Flaming Mode	141 D _m corrected typical
Smoldering Mode	311 D _m corrected typical
Acid Gas	
IEC 754-2	4.3 pH, 28 μS/cm
VDE 0472 Part 813	4.3 pH, 27 μS/cm
Toxicity Index	
NES 713	1

Low-Smoke, Zero-Halogen Jacketed Cable Specifications

600V, 90°C TC-LS NEC 340/UL 1277 & 1685

Instrumentation

- 18 to 12 AWG, BC or TC
- 90°C XLPE insulation
- UL 44 XHHW-2 — 90°C dry/wet
- Shielded or unshielded
- Haloarrest jacket

Control or Power

- 14 to 4/0 AWG, BC or TC
- 90°C XLPE insulation
- UL 44 XHHW-2 — 90°C dry/wet
- Shielded or unshielded
- Haloarrest jacket

Hazardous Locations Cable Reference

Article 500

Class I Division 1 Hazards

- Locations where flammable gases or vapors may exist under normal operating conditions, under frequent repair or maintenance operations, or where breakdown or faulty operation of process equipment might also cause simultaneous failure of electrical equipment.
- Use conduit or MI cable with approved termination fittings.

Class I Division 2 Hazards

- Locations where flammable gases, vapors or volatile liquids are handled either in a closed system, or confined within suitable enclosures, or where hazardous concentrations are normally prevented by positive mechanical ventilation. Areas adjacent to Division 1 areas belong in Division 2.
- Use PLTC, ITC, TC, MC, MV, MI with approved termination fittings.

Class II Division 1

- Locations where combustible dusts exist under normal conditions.
- Use conduit or MI with approved termination fittings.

Class II Division 2

- Locations where combustible dusts exist under abnormal conditions.
- Use conduit or PLTC, ITC, TC, MC with ventilated channel cable trays.
- Use conduit or MC, MI with approved termination fittings.

Class III Division 1

- Locations where easily ignitable fibers and flyings exist under normal conditions.
- Use conduit or MC, MI with approved termination fittings.

Class III Division 2

- Locations where easily ignitable fibers and flyings exist under abnormal conditions.
- Use conduit or MC, MI with approved termination fittings.

Article 504

Intrinsically Safe

- Equipment and wiring that are incapable of releasing sufficient electrical energy under normal or abnormal conditions to cause ignition of a specific hazardous atmospheric mixture in its most easily ignited concentration.
- Use CL3, CL2, PLTC, TC or CM cable, colored light blue, with approved sealing and separation.

Hazardous Location Cable Reference per Canadian Electrical Code CEC Section 18

All Armored cables printed "HL" per CSA C22.2 #174 are rated for all Hazardous Location Classes and Divisions (ie. Class 1, Div. 1).

All Tray Cables printed "TC" per per CSA C22.2 #230 are rated for all Hazardous Location Classes and Division 2 or lower. (ie. Class 1, Div. 2 or lower).

Technical Information

UL Approved Insulation/Jacketing Options

UL Listed for MC and TC			
Insulation/Jacket	Max. Temp Rating		Flame Tests
	Wet	Dry	
PVC-Nylon/PVC (THHN or THWN) 14 AWG & larger	75°C	90°C	UL 1685 FT4/ IEEE 1202/383 ICEA T-29-520
PVC-Nylon/PVC (TFN or TFFN) 16 & 18 AWG	NA	90°C	UL 1685 FT4/ IEEE 1202/383 ICEA T-29-520
XLPE/PVC or CPE (XHHW-2) 14 AWG & larger	90°C	90°C	UL 1685 FT4/ IEEE 1202/383 VW-1 rated singles ICEA T-29-520
XLPE/PVC or CPE (RFH-2) 16 & 18 AWG	75°C	75°C	UL 1685 FT4/ IEEE 1202/383 VW-1 rated singles ICEA T-29-520
FRPO/PVC 18 AWG & larger	—	75°C	UL 1685
TPE/TPE	75°C	90°C	UL 1685
FRPO/PVC	75°C	90°C	UL 1685
XLPE/Haloarrest (XHHW-2) 14 AWG & larger	90°C	90°C	UL 1685 FT4/IEEE 1202/383 ICEA T-29-520
XLPE/Haloarrest (RFH-2) 16 & 18 AWG	75°C	75°C	UL 1685 FT4/IEEE 1202/383 ICEA T-29-520
FEP/PVC	90°C	90°C	UL 1685

UL Listed for PLTC	
Insulation/Jacket	Max. Temp Rating
XLPE/PVC	90°C
XLPE/CPE	90°C
PVC/PVC	105°C
PVC/CPE	105°C
PE/PVC	75°C
FPE/PVC	75°C
TPE/TPE	105°C
XLPE/Haloarrest®	90°C
FEP/FEP	200°C

Abbreviations Key

CPE	Chlorinated Polyethylene
FEP	Fluorinated Ethylene-propylene
FPE	Foam Polyethylene
FRPO	Flame-Retardant Polyolefin
PE	Polyethylene
PVC	Polyvinyl Chloride Nylon insulated singles are type THHN or THWN for conductors 14 AWG or larger. Conductor sizes 16 and 18 AWG are Type TFN or TFFN singles.
TPE	Thermoplastic Elastomer
XLPE	Cross-Linked Polyethylene Cross-Linked Polyethylene (XLPE) insulated singles are type XHHW-2 for conductors 14 AWG or larger. Conductor sizes 16 and 18 AWG are RFH-2.

Vertical Tray Flame Test Comparison

Test	UL-1685 (UL-1581)	FT4/IEEE 1202/ IEEE 383-2003	IEEE 383-1974	IEC 323-3	ICEA T-29-520
Flame Test Chamber	Vertical Tray	Vertical Tray	Vertical Tray	Vertical Tray	Vertical Tray
Burner Type	Ribbon gas burner	Ribbon gas burner	Ribbon gas burner	Ribbon gas burner	Ribbon gas burner
Theoretical Heat Input	70,000 BTU/hr	70,000 BTU/hr	70,000 BTU/hr	70,000 BTU/hr	210,000 BTU/hr
Burner Positioning	horizontal 3" from samples 18" from tray base	20° up from horizontal 2.95" from cable surface 11.8" above floor	horizontal 3" from samples 18" above tray bottom	horizontal 2.95" from cable surface 23.6" above floor	horizontal 8-1/4" from cable surface 12-1/4" above tray base
Tray Dimensions	8' length 12" width 3" side flanges	9.84' length 11.81" width 2.85" side flanges	8' length 12" width 3" side flanges	11.5' length 19.7" width none	8' length 12" width 3" side flanges
Sample Spacing	1/2 cable diameter	1/2 cable diameter	1/2 cable diameter	lesser of 1/2 cable diameter and .78"	1/2 cable diameter
Duration of Flame Application	20 minutes	20 minutes	20 minutes	20 minutes	20 minutes
Mode of Failure	Cable blistering or charring has reached the top of the sample after the cable has self-extinguished.	Cable char has exceeded a length of 4.92'.	Cable blistering or charring has reached the top of the sample after the cable has self-extinguished.	Cable charring has reached a height of 98.4" above the bottom of the burner.	Cable blistering or charring has reached the top of the sample after the cable has self-extinguished.



Broadcast Cables

Table of Contents

Broadcast Cables	Page No.
Introduction	19.2
Microphone and Musical Instrument Cable	19.3–19.8
Single-Conductor, High-Impedance	19.4
Two-Conductor, Low-Impedance	19.5
Three-Conductor, Low-Impedance	19.7
Four-Conductor Star Quad, Low-Impedance	19.8
Line Level Analog Audio Cable	19.9–19.15
Single- and Double-Pair	19.9
Analog Multi-Pair Snake Cable	19.16–19.25
Super-Flexible, High-Performance, 26 AWG Star Quads	19.17
CMR Rated, 24 AWG Twisted Pairs	19.18
Flexible, CM Rated, 24 AWG Twisted Pairs	19.19
FlexSnake® Super-Flexible, 24 AWG Twisted Pairs	19.20
CMR Rated, 22 AWG Twisted Pairs	19.21
Flexible Low-Capacitance, 22 AWG Twisted Pairs	19.22
CM Rated, 22 AWG Twisted Pairs	19.23
CMP Rated, 22 AWG Plenum Twisted Pairs	19.24
AES/EBU Digital Audio Cable	19.26–19.30
Single- and Double-Pair	19.27
Multi-Pair Snake Cables	19.28
Speaker Wire and Cable	19.31–19.37
Electrolytic Tough Pitch (ETP) Speaker Cables	19.32
Low-Cap, Oxygen-Free High-Conductivity (OFHC) Speaker Cables	19.36
High-Flex Bi-amp and Tri-amp Speaker Connections	19.37
Special Audio, Communication & Instrumentation Cable	19.38–19.40
Audio Connecting Cables	19.38
Dual Channel Audio Cables	19.38
Multimedia Control Cables	19.39
Microphone/Musical Instrument Cables	19.40
75 Ohm Standard Analog Video Coax	19.41–19.48
Miniature Coax	19.41
High-Frequency Conformable® Coax	19.42
RG-59/U Type	19.43
RG-6/U Type	19.47
RG-11/U Type	19.48
Precision Video Coax for Analog and Digital	19.49–19.58
Subminiature RG-59/U Type	19.50
Miniature RG-59/U Type	19.51
RG-59/U Type	19.52
RG-59/U Type, Double Braided	19.52
RG-6/U Type, Low Loss Serial Digital	19.54
RG-11/U Type, Low Loss Serial Digital	19.54
Bundled VideoFLEX® Snake Cables	19.55
Parallel Digital Video	19.57
Digital Video Time Code	19.58
Precision Video Twinax	19.58
Video Triax Cable	19.59–19.62
A/V and Composite Camera Cable	19.63–19.68
RGB Component Video Cable	19.69–19.73
RJ-45 Cable for A/V Applications	19.74–19.76
S-Video Cable	19.77
Technical Information	19.78

Introduction



Broadcast — there is perhaps no other industry which values performance so highly, for the lack of broadcast performance has immediate, far-reaching, and embarrassing results.

That's why the broadcast industry prefers Belden® cable. From major network events such as the Olympics, space launches, and presidential news conferences to everyday audio and video applications, Belden is the local, regional, and national choice. The overwhelming reason? Performance.

In broadcast, cable performance means ensured product quality, absolute signal integrity, and no system downtime. Belden products provide performance for both critical field applications (where cable is dragged, crunched, trod, and tread upon) and permanent studio installations (where the long run is all important). Belden products are an important link in network and cable broadcasts (NBC Nightly News, Lifetime Cable Network, CNN News, and CNN Headline News), film studios (Lucasfilm) and corporate broadcasting (USA Today, Merrill Lynch).

Watch television last night or listen to the radio this morning? Chances are the link was made with Belden cable. And with dedication to development and innovation, the chance the link will be Belden increases.

Committed to Product Innovation and Technical Excellence

Belden's commitment to product innovation and technical excellence in the broadcast industry has resulted in a line of dependable audio and video cabling products called Brilliance®. Named for the sound and picture brilliance obtainable through new product innovations and improved signal integrity, Brilliance encompasses all Belden Audio/Video products. The line includes:

- High-Conductivity Microphone Cables
- Analog/Digital Audio Cables
- Speaker Cables
- Precision Analog/Digital Video Cables
- Triaxial Cables
- Audio/Video Composite Cables
- RGB & Component Video Cables
- Multimedia Cables
- Fiber Optic Cable
(See Fiber Optic Section)

Most of our Brilliance cables are available from stock. Many of these are available off the shelf from distributors. If you have a new or unusual application or you cannot find Brilliance cable in this catalog section that meets your technical requirements, contact Technical Support at 1-800-BELDEN-1.

Performance Features

Innovative Shielding

Belden shielded cable ensures signal integrity and provides confidence in audio and video transmissions, preventing downtime and maintaining sound and picture clarity. Among the shield types available are: braid shields, foil shields, combination shields and Belden's patented "French Braid" shield.

"French Braid" Shields

Belden's patented "French Braid" shield is a double spiral (double serve bare copper shield) with the two spirals tied together by one weave. This construction provides improved flex life over standard spiral shields, improved flexibility over conventional braid shields, and lower levels of microphonic or triboelectric noise than either spiral or conventional braid shields. The "French Braid" is easier to terminate than a standard braid since it is not fully woven. It also provides for a lower DC loop resistance than a single spiral braid for improved performance.

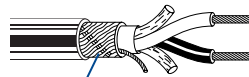

French Braid

Special Noise/Interference Problems in Broadcasting

Triboelectric noise is generated by mechanical motion of a cable, causing movement in the cable's shield. Belden detects and measures triboelectric noise through the use of Low Noise Test equipment. Belden developed the test procedure and the equipment based on a combination of three low noise standards: NBS, ISA-S, and MIL-C-17.

Mechanically induced noise is a critical and frequent concern in the use of guitar cords and microphone cables. Belden rigorously employs the properties of special conductive tapes and insulations to prevent these noise problems.

Insulations

Belden formulates its own insulations to provide superior performance under a variety of broadcast environment conditions while meeting the electrical requirements of specific applications. Belden cables are available in a number of UL Listed and CSA Approved insulation compounds. Insulation materials include polyethylene, polypropylene, PVC, fluorinated ethylene-propylene (FEP) and Belden's Datalene® — a crush-resistant, lightweight insulation that provides a low dielectric constant and dissipation factor that's well suited to high-speed, low-distortion data handling.

Jackets

Belden broadcast cables are manufactured in a wide selection of standard jacketing materials. Special compounds and variations of standard compounds are used to meet critical broadcast application requirements and unusual environmental conditions. Proper matching of cable jackets to their working environment can prevent deterioration due to intense heat and cold, sunlight, mechanical abuse, impact and crowd or vehicle traffic. Jacket materials offered include PVC (in standard and matte finishes), polyethylene, FEP, Neoprene, Hypalon®, silicone rubber and natural rubber.

For more detailed information and assistance in selecting the correct cable component features for your needs, please refer to the Technical Information section of this catalog.

Hypalon is a DuPont trademark.

Microphone and Musical Instrument Cable

Overview



Flexible Microphone Cables

Belden® microphone cable is used for connecting low level microphones or musical instruments. Key properties of microphone (MIC) cable are ruggedness, flexibility, flex life and interference immunity.

MIC cable constructions utilize either 1-, 2-, 3- or 4-conductor configurations. Cable selection depends on whether the MIC or instrument is of a high- or low-impedance design. High-impedance MICs require unbalanced single conductor (coaxial) cables while low-impedance MICs utilize balanced 2-, 3-, or 4-conductor (quad) designs. Quad MIC cables are connected by attaching the two white conductors to one pin and two blue conductors to the other pin in a balanced-line XLR type connector. Besides the common-mode rejection of a standard balanced line, this gives common-mode rejection at each pin, greatly reducing noise and interference.

High-conductivity Copper

All Belden microphone cables with bare copper conductors utilize only high-conductivity copper produced by a process called Electrolytic Tough Pitch (ETP). This refining process produces a copper conductor that is 99.95% pure copper resulting in high-conductivity per ASTM B115. The high purity obtained from ETP copper results in microphone cable performance that is comparable to that of oxygen-free copper cables.

- **Plastic cables recommended for:**
Lower capacitance, lower loss, greater ozone and oil resistance, lighter weight, smaller diameter.
- **Rubber cables recommended for:**
Greater abrasion and impact resistance and extra limpness so the cable will lie flat on stage or on studio floors.

Four-Conductor Star Quad Low-Impedance Cables

Quad connection scheme: The two blue wires (or wires directly opposite one another) are connected together to form one conductor, and similarly the two white wires (or remaining wires) are connected together to form the second conductor.

Conductors joined in this manner lower the possibility of induced noise.

Microphone and Musical Instrument Cable

Single-Conductor, High-Impedance Cables

High-Conductivity Copper

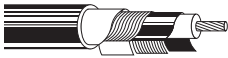
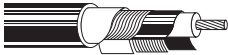
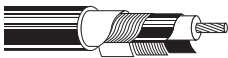

Description	Part No.	UL NEC/ C(UL) CEC Type	No. of Cond.	Color Code	Standard Lengths		Standard Unit Weight		Insulation Thickness		Jacket Thickness		Nominal OD		Nominal Capacitance			
					Ft.	m	Lbs.	kg	Inch	mm	Inch	mm	Inch	mm	* pF/ Ft.	* pF/ m	** pF/ Ft.	** pF/ m

25 AWG Stranded (7x33) Composite Copper Conductor • (3) Strands TC, (4) Strands TCCS • TC Spiral Shield (90% Coverage)**PVC Insulation • Matte Gray PVC Jacket**1000 VDC, 60°C **9396** — 1 N/A 250 76.2 2.8 1.3 .018 .46 .017 .43 .100 2.54 — — 75 246**25 AWG** Stranded (7x33) Composite Copper Conductor† • Rayon Braid + TC Braid Shield (80% Coverage) • Cotton Serve**EPDM Rubber Insulation • Cotton Serve • Black EPDM Rubber Jacket**3000 VDC, 60°C **8410** — 1 N/A 500 152.4 18.5 8.4 .058 1.47 .024 .61 .245 6.22 — — 33 108**20 AWG** Stranded (27x34) High-conductivity TC Conductor • Conductive Textile (100%) plus TC Spiral Shields (95% Coverage) • Paper Tape**EPDM Rubber Insulation • Black Neoprene Jacket**60°C **9394** — 1 N/A 1000 304.8 26.0 11.8 .030 .76 .033 .84 .190 4.83 — — 55 180**20 AWG** Stranded (26x34) High-conductivity TC Conductor • Conductive Textile (100%) plus TC Spiral Shields (75% Coverage) • Paper Tape**EPDM Rubber Insulation • Black Neoprene Jacket**60°C **9778** — 1 N/A 1000 304.8 39.0 17.7 .040 1.02 .050 1.27 .235 5.97 — — 45 148**18 AWG** Stranded (41x34) High-conductivity TC Conductor • Conductive Textile (100%) plus TC Spiral Shields (68% Coverage) • Paper Tape**EPDM Rubber Insulation • Black Neoprene Jacket**600V RMS, 60°C **9395** — 1 N/A 1000 304.8 38.0 17.2 .045 1.14 .034 .86 .235 5.97 — — 55 180

EPDM = Ethylene Propylene Diene Monomer • TC = Tinned Copper • TCCS = Tinned Copper-covered Steel

*Capacitance between conductors.

**Capacitance between center conductor and outer shield.

†(3) Strands TC, (4) Strands TCCS.

Microphone and Musical Instrument Cable

Two-Conductor, Low-Impedance Cables
High-Conductivity Copper



Description	Part No.	UL NEC/ C(UL) CEC Type	No. of Cond.	Color Code	Standard Lengths		Standard Unit Weight		Insulation Thickness		Jacket Thickness		Nominal OD		Nominal Capacitance			
					Ft.	m	Lbs.	kg	Inch	mm	Inch	mm	Inch	mm	* pF/ Ft.	* pF/ m	** pF/ Ft.	** pF/ m

24 AWG Stranded (105x44) High-conductivity Bare Copper Conductors† • Double Bare Copper Spiral Shield (97% Coverage)

PVC Insulation • Matte Black PVC Jacket

300V RMS 80°C	9397	—	2	White, Green	500	152.4	12.0	5.5	.012	.30	.031	.79	.176	4.47	47	154	86	283
					1000	304.8	24.0	10.9										



24 AWG Stranded (45x40) TC Alloy Conductors† • Conductive Textile Wrap (100% Coverage) • TC Braid Shield (56% Coverage) • Cotton Spiral

EPDM Rubber Insulation • Black EPDM Jacket

300V RMS 90°C	8413	—	2	White, Black	100	30.5	2.3	1.0	.016	.41	.017	.43	.199	5.05	30	98	55	180
					U-500	U-152.4	13.0	5.9										
					500	152.4	11.5	5.2										



24 AWG Stranded (45x40) BC Alloy Conductors† • Conductive Textile Wrap (100% Coverage) • TC Braid Shield (65% Coverage) • Cotton Spiral

EPDM Rubber Insulation • Brown EPDM Jacket

300V RMS 90°C	9399	—	2	Blue, Red	500	152.4	12.5	5.7	.016	.41	.020	.51	.200	5.08	30	98	55	180
---------------	-------------	---	---	--------------	-----	-------	------	-----	------	-----	------	-----	------	------	----	----	----	-----



24 AWG Stranded (42x40) High-conductivity BC Conductors† • TC “French Braid” Shield (95% Coverage) • BC Drain Wire

Datalene® Insulation • Matte PVC Jacket (Available in Red, Yellow, Green, Blue, Gray or Black)

Digital MIC Cable	1800F	NEC:	2	Black,	500*	152.4	12.0	5.5	.017	.43	.037	.94	.211	5.36	12	39	26	85
High-Flex	110 Ohm	CL2R		Red	U-1000	U-304.8	26.0	11.8										
300V RMS 60°C	AES/EBU				1000*	304.8	24.0	10.9										

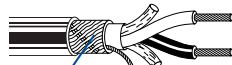

French Braid

*500 ft. and 1000 ft. put-ups available in Black only.

24 AWG Stranded (42x40) High-conductivity BC Conductors† • Double Bare Copper Spiral Shield (95% Coverage)

PVC Insulation • PVC Inner Jacket • Matte PVC Outer Jacket (Available in Red, Yellow, Green, Blue or Black)

100V RMS 60°C	1812A	—	2	Brown, White	328*	100.0	9.8	4.5	.012	.30	.037	.94	.213	5.41	33	108	54	177
					1000	304.8	31.0	14.1										

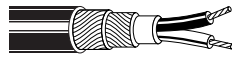

*328 ft. put-up not available in Green.

BC = Bare Copper • EPDM = Ethylene Propylene Diene Monomer • TC = Tinned Copper

*Capacitance between conductors.

**Capacitance between one conductor and other conductors connected to shield.

†Conductors cabled with fillers.

Not RoHS compliant at time of printing. Please check with Belden Technical Support for current compliance information at 1-800-BELDEN-1.

Datalene insulation features include a low dielectric constant and a low dissipation factor for high-speed, low-distortion data handling. Physical properties include good crush resistance and light weight.

Microphone and Musical Instrument Cable

Two-Conductor, Low-Impedance Cables

High-Conductivity Copper



Description	Part No.	UL NEC/ C(UL) CEC Type	No. of Cond.	Color Code	Standard Lengths		Standard Unit Weight		Insulation Thickness		Jacket Thickness		Nominal OD		Nominal Capacitance			
					Ft.	m	Lbs.	kg	Inch	mm	Inch	mm	Inch	mm	* pF/ Ft.	* pF/ m	** pF/ Ft.	** pF/ m

24 AWG Stranded (19x36) HC TC Conductors • Twisted Pair • Noise Reducing Tape • Beldfoil® Shield (100% Coverage) • TC Drain Wire

High-density Polyethylene Insulation • Black PVC Jacket

200V RMS 75°C	9452	—	2	Black, Red	U-500	U-152.4	6.5	3.0	.008	.20	.020	.51	.135	3.43	30	98	58	190			
					500	152.4	6.0	2.7													
					U-1000	U-304.8	12.0	5.5													
					1000	304.8	12.0	5.5													

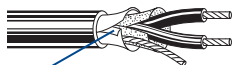

Shorting Fold

24 AWG Stranded (27x38) High-conductivity Bare Copper Conductors • Bare Copper Spiral Shield (92% Coverage)

PVC Insulation • Black Matte PVC Jacket

100V RMS 60°C	1813A	—	2	Red, Blue	328	100.0	10.2	4.6	.017	.43	.055	1.40	.236	5.99	33	108	61	200
					1000	304.8	31.0	14.1										



22 AWG Stranded (16x34) High-conductivity Tinned Copper Conductors • Cotton Braid • Double TC Braid Shield (85% Coverage)

Polyethylene Insulation • Chrome PVC Jacket

1000V RMS 80°C	8422	—	2	Clear, Black	500	152.4	15.0	6.8	.021	.53	.022	.56	.231	5.87	18	59	32	105		
					U-1000	U-304.8	31.0	14.1												
					1000	304.8	33.0	15.0												



20 AWG Stranded (26x34) High-conductivity TC Conductors • Rayon Braid • TC Braid Shield (85% Coverage) • Cotton Wrap

EPDM Rubber Insulation • EPDM Jacket (Available in Black, Red, Yellow or Blue)*

600V RMS 90°C	8412	—	2	White, Black	100	30.5	5.2	2.4	.023	.58	.035	.89	.262	6.65	30	98	55	180			
					250	76.2	12.0	5.5													
					U-500	U-152.4	24.0	10.9													
					500	152.4	22.0	10.0													
					U-1000	U-304.8	46.0	20.9													
					1000	304.8	47.0	21.4													

*Red, Yellow or Blue available in 1000 ft. put-up only.

EPDM Rubber Insulation • Brown Hypalon® Jacket

600V RMS 60°C	8402	—	2	White, Black	500	152.4	25.0	11.3	.023	.58	.035	.89	.263	6.68	30	98	55	180
VW-1					U-1000	U-304.8	52.0	23.6										



18 AWG Stranded (41x34) High-conductivity TC Conductors • Rayon Braid • TC Braid Shield (85% Coverage) • Cotton Wrap

EPDM Rubber Insulation • Black Neoprene Jacket

600V RMS 60°C	8428	—	2	White, Black	100	30.5	6.3	2.8	.023	.58	.030	.76	.290	7.37	35	115	60	197			
					U-500	U-152.4	29.0	13.2													
					500	152.4	28.0	12.7													
					1000	304.8	59.0	26.8													



16 AWG Stranded (65x34) High-conductivity TC Conductors • Rayon Braid • Paper Wrap • TC Braid Shield (85% Coverage) • Cotton Wrap

EPDM Rubber Insulation • Brown Hypalon® Heavy-duty Jacket

600V RMS 60°C	8408	—	2	Black, White	500	152.4	50.0	22.7	.037	.94	.040	1.02	.380	9.65	30	98	55	180
VW-1																		



BC = Bare Copper • EPDM = Ethylene Propylene Diene Monomer • HC = High-conductivity • TC = Tinned Copper

Hypalon is a DuPont trademark.

*Capacitance between conductors. **Capacitance between one conductor and other conductors connected to shield.



For more information, contact Belden Technical Support: 1-800-BELDEN-1 • www.belden.com

Microphone and Musical Instrument Cable

Three-Conductor, Low-Impedance Cables

High-Conductivity Copper



19 • Brilliance® Broadcast

Description	Part No.	UL NEC/ C(UL) CEC Type	No. of Cond.	Color Code	Standard Lengths		Standard Unit Weight		Insulation Thickness		Jacket Thickness		Nominal OD		Nominal Capacitance			
					Ft.	m	Lbs.	kg	Inch	mm	Inch	mm	Inch	mm	* pF/ Ft.	* pF/ m	** pF/ Ft.	** pF/ m

24 AWG Stranded (105x44) High-conductivity Bare Copper Conductors • Double Bare Copper Spiral Shield (97% Coverage)

PVC Insulation • Matte Black PVC Jacket

300V RMS 80°C	9398	—	3	White, Green, Brown	1000	304.8	25.0	11.4	.012	.30	.030	.76	.185	4.70	40	131	110	361
---------------	-------------	---	---	---------------------	------	-------	------	------	------	-----	------	-----	------	------	----	-----	-----	-----



24 AWG Stranded (45x40) TC Alloy Conductors • Conductive Textile Wrap (100% Coverage) • TC Braid Shield (60% Coverage)

EPDM Rubber Insulation • Black EPDM Rubber Jacket

300V 90°C	8406	—	3	Black, Red, White	100	30.5	3.0	1.4	.016	.41	.025	.64	.223	5.66	30	98	55	180
					500	152.4	15.0	6.8										



24 AWG Stranded (19x32) High-conductivity Tinned Copper Conductors • Rayon Braid • TC Braid Shield (89% Coverage)

Polyethylene Insulation • Chrome PVC Jacket

600V RMS 80°C	8403	—	3	Clear, Black, Red	500	152.4	20.5	9.3	.016	.41	.033	.84	.244	6.20	25	82	45	148
VW-1					1000	304.8	45.0	20.5										



20 AWG Stranded (26x34) High-conductivity TC Conductors • Rayon Braid • TC Braid Shield (85% Coverage) • Cotton Wrap

EPDM Rubber Insulation • Black EPDM Jacket

600V RMS 90°C	8423	—	3	White, Black, Red	100	30.5	6.0	2.7	.023	.58	.040	1.02	.272	6.91	30	98	55	180
					500	152.4	26.0	11.8										
					1000	304.8	56.0	25.5										

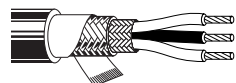

EPDM = Ethylene Propylene Diene Monomer • TC = Tinned Copper

*Capacitance between conductors.

**Capacitance between one conductor and other conductors connected to shield.

Not RoHS compliant at time of printing. Please check with Belden Technical Support for current compliance information at 1-800-BELDEN-1.

Microphone and Musical Instrument Cable

Four-Conductor Star Quad, Low-Impedance Cables†
High-Conductivity Copper



Description	Part No.	UL NEC/ C(UL) CEC Type	No. of Cond.	Color Code	Standard Lengths		Standard Unit Weight		Insulation Thickness		Jacket Thickness		Nominal OD		Nominal Capacitance			
					Ft.	m	Lbs.	kg	Inch	mm	Inch	mm	Inch	mm	* pF/ Ft.	* pF/ m	** pF/ Ft.	** pF/ m

28 AWG Stranded (19x40) High-conductivity Silver-plated Copper Alloy Conductors • Tinned Copper Braid Shield (78% Coverage)

Polypropylene Insulation • Matte PVC Jacket (Available in Red, Yellow, Blue, Beige or Black)

Mini Star Quad 100V RMS 60°C 	1804A	—	4	Blue/White, White/Blue	100 ▲	30.5	1.6	0.7	.006	.15	.014	.36	.115	2.92	40	131	60	197
					500 ■	152.4	4.5	2.0										

2/c 25 AWG equivalent DCR when connected to a 3-pin XLR.

▲100 ft. put-up available in Black only.

■May contain more than one piece. Min. length of any one piece is 50 ft.

One Blue conductor and one White conductor are striped for use in MIDI and other four conductor applications.

26 AWG Stranded (30x40) High-conductivity BC Conductors • TC “French Braid” Shield (95% Coverage) • BC Drain Wire

Polyethylene Insulation • Matte PVC Jacket (Available in Red, Green, Yellow, Blue, Gray or Black)

100V RMS 60°C 	1172A	—	4	Blue/White, White/Blue	500 *	152.4	13.5	6.1	.011	.28	.030	.76	.190	4.83	39	128	57	187
					1000	304.8	25.0	11.3										

2/c 23 AWG equivalent DCR when connected to a 3-pin XLR.

French Braid

*500 ft. put-up available in Black only.

One Blue conductor and one White conductor are striped for use in MIDI and other four conductor applications.

24 AWG Stranded (42x40) High-conductivity Bare Copper Conductors • Tinned Copper Braid Shield (95% Coverage)

Polyethylene Insulation • Matte PVC Jacket (Available in Red, Green, Yellow, Blue, Gray or Black)

100V RMS 75°C 	1192A	—	4	Blue/White, White/Blue	100 ▼	30.5	4.1	1.8	.016	.41	.045	1.14	.245	6.22	39	128	57	187			
					500 ▼	152.4	16.5	7.5													
					1000	304.8	37.0	16.8													

2/c 21 AWG equivalent DCR when connected to a 3-pin XLR.

▼100 ft. put-up available in Black only. 500 ft. put-up available in Blue or Black only.

One Blue conductor and one White conductor are striped for use in MIDI and other four conductor applications.

20 AWG Stranded (19x32) High-conductivity Tinned Copper Conductors • Rayon Braid • Tinned Copper Braid Shield (85% Coverage)

Polyethylene Insulation • Chrome PVC Jacket

UL AWM Style 2094 (300V RMS 60°C) VW-1 	8404	—	4	Clear,	100	30.5	5.4	2.4	.016	.41	.032	.81	.252	6.40	23	75	49	161				
					Black,	500	152.4	23.0	10.4													
					Red,	U-1000	U-304.8	48.0	21.8													
					Green	1000	304.8	49.0	22.3													

2/c 17 AWG equivalent DCR when connected to a 3-pin XLR.

20 AWG Stranded (26x34) High-conductivity Tinned Copper Conductors • Rayon Braid • TC Braid Shield (85% Coverage) • Cotton Wrap

EPDM Rubber Insulation • Black EPDM Rubber Jacket

600V RMS 90°C 	8424	—	4	Black,	100	30.5	6.8	3.1	.023	.58	.036	.91	.294	7.47	47	154	59	194				
					White,	250	76.2	15.3	6.9													
					Red,	U-500	U-152.4	32.0	14.5													
					Green	500	152.4	30.5	13.8													
						1000	304.8	64.0	29.1													

2/c 17 AWG equivalent DCR when connected to a 3-pin XLR.

16 AWG Stranded (65x34) High-conductivity Tinned Copper Conductors • Rayon Braid • TC Braid Shield (85% Coverage) • Cotton Wrap

EPDM Rubber Insulation • Black Neoprene Jacket

600V RMS 60°C VW-1 	8407	—	4	Black,	100	30.5	11.3	5.1	.031	.79	.043	1.09	.416	10.57	30	98	66	216				
					White,	250	76.2	28.3	12.8													
					Red,																	
					Green																	

2/c 13 AWG equivalent DCR when connected to a 3-pin XLR.

BC = Bare Copper • EPDM = Ethylene Propylene Diene Monomer • TC = Tinned Copper

*Capacitance between conductors. **Nom. capacitance between conductors in a Quad configuration.

†**Quad connection scheme:** The two blue wires (or wires directly opposite one another) are connected together to form one conductor, and similarly the two white wires (or remaining wires) are connected together to form the second conductor.

⚠ Not RoHS compliant at time of printing. Please check with Belden Technical Support for current compliance information at 1-800-BELDEN-1.



For more information, contact **Belden Technical Support: 1-800-BELDEN-1 • www.belden.com**

Line Level Analog Audio Cable

Single-Pair Cables



Belden analog audio cables are used for connecting line level audio equipment in either permanent or semi-permanent installations. They consist of one or two individually foil-shielded, twisted pairs. Once installed, they are not intended to be moved while in service. For cables that are in motion during use, refer to the Microphone and Musical Instrument Cable section in this catalog.

no. 8451 utilizes a paper tape separator to facilitate easy long length jacket stripping. Part no. 9451 comes with a bonded Beldfoil® shield so that the shield and jacket strip simultaneously. A special matte PVC jacket material is employed on part no. 1508A making it a highly flexible construction. Double pair cables are available in a round construction (part no. 8723) or in a ZIP cord style (part no. 1504A) for easy separation in two-channel or stereo hook-ups.

Belden's analog audio cable offering consists of a selection of designs to handle a variety of audio applications. Belden part

Description	Part No.	UL NEC/ C(UL) CEC Type	No. of Pairs	Color Code	Standard Lengths		Standard Unit Weight		Insulation Thickness		Jacket Thickness		Nominal OD		Nominal Capacitance			
					Ft.	m	Lbs.	kg	Inch	mm	Inch	mm	Inch	mm	* pF/ Ft.	* pF/ m	** pF/ Ft.	** pF/ m

24 AWG Stranded (7x32) TC Conductors • Twisted Pair • Overall Beldfoil Shield (100% Coverage) • 24 AWG Stranded TC Drain Wire

Polypropylene Insulation • PVC Jacket (Available in Brown, Red, Green, Lt. Blue, Purple, Gray, White or Black)

300V RMS 60°C	1883A	NEC: CMR CEC: CMG FT4	1	Black, Red	U-1000 1000 [▲]	U-304.8 304.8	11.0 11.0	5.0 5.0	.008 .20	.020 .51	.123 3.12	31 102	58 190				
---------------	--------------	--------------------------------	---	---------------	-----------------------------	------------------	--------------	------------	-------------	-------------	--------------	-----------	-----------	--	--	--	--



[▲]1000 ft. put-up available in Gray only.
Jacket and shield are bonded so both can be removed with automatic stripping equipment.

For cross-connect use with 1408R (et al.) Snake Cables, see page 19.18.

Polyolefin Insulation • Black Matte PVC Jacket

High-Flex 300V RMS 60°C	1508A	NEC: CM CEC: CM	1	Black, Red	500 1000	152.4 304.8	6.5 11.0	2.9 5.0	.008 .20	.024 .61	.131 3.33	31 102	58 190				
----------------------------	--------------	--------------------------	---	---------------	-------------	----------------	-------------	------------	-------------	-------------	--------------	-----------	-----------	--	--	--	--



Jacket and shield are bonded so both can be removed with automatic stripping equipment.

For cross-connect use with 1408R (et al.) Snake Cables, see page 19.18.

24 AWG Stranded (7x32) TC Conductors • Twisted Pair • Overall Beldfoil Shield (100% Coverage)^{††} • 24 AWG Stranded TC Drain Wire

Polyethylene Insulation • Chrome PVC Jacket

Low-Capacitance UL AWM Style 2092 (300V RMS 60°C)	8641	NEC: CM CEC: CM	1	Black, Clear	100 U-500 500 U-1000 1000 2000	30.5 U-152.4 152.4 U-304.8 304.8 609.6	2.3 7.5 7.0 14.0 14.0 28.0	1.0 3.4 3.2 6.4 6.4 12.7	.016 .41	.025 .64	.168 4.27	22 72	42 138				
---	-------------	--------------------------	---	-----------------	---	---	---	---	-------------	-------------	--------------	----------	-----------	--	--	--	--



For Plenum versions of 8641, see 88641 or 82641.

Plenum • FEP Insulation • Red FEP Jacket

300V RMS 200°C, Non-conduit	88641	NEC: CMP CEC: CMP FT6	1	Black, Red	100 500 [†] 1000 [†]	30.5 152.4 304.8	2.4 6.0 9.0	1.1 2.7 4.1	.006 .15	.014 .36	.106 2.69	31 102	59 194				
-----------------------------	--------------	--------------------------------	---	---------------	--	------------------------	-------------------	-------------------	-------------	-------------	--------------	-----------	-----------	--	--	--	--



Plenum • FEP Insulation • Natural Flamarrest® Jacket

300V RMS 60°C, Non-conduit	82641	NEC: CMP CEC: CMP FT6	1	Black, Red	U-1000 ^{††} 1000 ^{††}	U-304.8 304.8	9.0 8.0	4.1 3.6	.006 .15	.014 .36	.106 2.69	31 102	59 194				
----------------------------	--------------	--------------------------------	---	---------------	--	------------------	------------	------------	-------------	-------------	--------------	-----------	-----------	--	--	--	--



FEP = Fluorinated Ethylene Propylene • TC = Tinned Copper

*Capacitance between conductors.
**Capacitance between one conductor and other conductors connected to shield.

[†]Spools and/or UnReel® cartons are one piece, but length may vary ±10% for spools and ±5% for UnReel from length shown.
^{††}Length may vary ±10% for UnReel.



Line Level Analog Audio Cable

Single-Pair Cables



Description	Part No.	UL NEC/ C(UL) CEC Type	No. of Pairs	Color Code	Standard Lengths		Standard Unit Weight		Insulation Thickness		Jacket Thickness		Nominal OD		Nominal Capacitance			
					Ft.	m	Lbs.	kg	Inch	mm	Inch	mm	Inch	mm	* pF/ Ft.	* pF/ m	** pF/ Ft.	** pF/ m

22 AWG Stranded (7x30) TC Conductors • Twisted Pair • Overall Beldfoil® Shield (100% Coverage) • 24 AWG Stranded TC Drain Wire

Polypropylene Insulation • PVC Jacket (Available in Brown, Red, Orange, Yellow, Green, Blue, Purple, Gray, White or Black)

300V RMS 60°C	1266A	NEC: CM CEC: CM	1	Black, Red	U-1000 1000 [▲]	U-304.8 304.8	15.0 15.0	6.8 6.8	.010 .25	.020 .51	.143 3.63	30 99	54 177				
---------------	--------------	--------------------------	---	---------------	-----------------------------	------------------	--------------	------------	-------------	-------------	--------------	----------	-----------	--	--	--	--

*1000 ft. put-up available in Black only.
Unique design features lower capacitance and greater flexibility than standard audio pair constructions.

PVC Insulation • PVC Jacket (Available in Brown, Red, Orange, Yellow, Green, Blue, Purple, Gray, White or Black)

300V RMS 90°C	1503A	NEC: CM CEC: CM	1	Black, Red	U-1000	U-304.8	16.0	7.3	.010 .25	.020 .51	.142 3.61	53 174	97 318				
---------------	--------------	--------------------------	---	---------------	--------	---------	------	-----	-------------	-------------	--------------	-----------	-----------	--	--	--	--

22 AWG Stranded (7x30) TC Conductors • Twisted Pair • Overall Beldfoil Shield (100% Coverage) • 22 AWG Stranded TC Drain Wire

Polypropylene Insulation • Paper Wrap • Gray or Black PVC Jacket

300V RMS 75°C	8451	NEC: CMR CEC: CMG FT4	1	Black, Red	100 [▼] U-500 500 1000	30.5 U-152.4 152.4 U-304.8 304.8	2.3 8.5 8.0 16.0 16.0	1.1 3.9 3.6 7.3 7.3	.008 .20	.020 .51	.138 3.51	34 111	67 220				
---------------	-------------	--------------------------------	---	---------------	--	--	-----------------------------------	---------------------------------	-------------	-------------	--------------	-----------	-----------	--	--	--	--

*100 ft. put-up available in Black only.
Unique paper separator facilitates jacket stripping.

Polypropylene Insulation • PVC Jacket (Available in Brown, Red, Orange, Yellow, Green, Blue, Purple, Gray, White or Black)

300V RMS 75°C	9451	NEC: CMR CEC: CMG FT4	1	Black, Red	U-500* 500* T-1000* U-1000 5000	U-152.4 152.4 T-304.8 U-304.8 1524.0	8.5 8.0 18.0 15.0 75.0	3.9 3.6 8.2 6.8 34.0	.008 .20	.020 .51	.135 3.43	35 115	67 220	For cross-connect use with 1814R (et al.) Snake Cables, see page 19.21			
---------------	-------------	--------------------------------	---	---------------	---	--	------------------------------------	----------------------------------	-------------	-------------	--------------	-----------	-----------	---	--	--	--

*U-500 ft., 500 ft. and T-1000 ft. put-ups available in Gray only.
The jacket and shield are bonded so both can be removed on automatic stripping equipment. Drain wire is inside foil shield.

Polypropylene Insulation • Black Low-Smoke, Zero-Halogen Jacket

LSZH and ABS Type Approved 300V RMS 105°C	9451SB <small>new</small>	NEC: CMG-LS CEC: CMG-LS FT4 Limited Smoke	1	Black, Red	1000	304.8	20.0	9.1	.008 .20	.032 .81	.160 4.06	35 114	67 220				
--	-------------------------------------	---	---	---------------	------	-------	------	-----	-------------	-------------	--------------	-----------	-----------	--	--	--	--

The jacket and shield are bonded so both can be removed on automatic stripping equipment. Drain wire is inside foil shield.

Plenum • FEP Insulation • Flamarest® Jacket (Brown, Red, Orange, Yellow, Green, Blue, Purple, Gray, White or Black)

300V RMS 60°C	9451P <small>new</small>	NEC: CMP CEC: CMP FT6	1	Black, Red	U-1000 5000	U-304.8 1524.0	16.0 75.0	7.3 34.0	.007 .18	.017 .43	.127 3.23	35 115	67 220				
---------------	------------------------------------	--------------------------------	---	---------------	----------------	-------------------	--------------	-------------	-------------	-------------	--------------	-----------	-----------	--	--	--	--

The jacket and shield are bonded so both can be removed on automatic stripping equipment. Drain wire is inside foil shield.

22 AWG Solid Tinned Copper Conductors • Twisted Pair • Overall Beldfoil Shield (100% Coverage) • 22 AWG Solid TC Drain Wire

Polypropylene Insulation • Gray or Black PVC Jacket

300V RMS 75°C	8450	NEC: CM CEC: CM	1	Black, Red	U-500* U-1000* 1000	U-152.4 U-304.8 304.8	7.5 14.0 13.0	3.4 6.4 5.9	.007 .18	.018 .46	.118 3.00	40 131	76 249				
---------------	-------------	--------------------------	---	---------------	---------------------------	-----------------------------	---------------------	-------------------	-------------	-------------	--------------	-----------	-----------	--	--	--	--

*U-500 ft. and U-1000 ft. put-ups available in Black only.
Belden's Miniature Type Broadcast Audio and Instrumentation Cables occupy 1/2 to 2/3 less space than standard cables.

FEP = Fluorinated Ethylene Propylene • TC = Tinned Copper

*Capacitance between conductors.
**Capacitance between one conductor and other conductors connected to shield.



Line Level Analog Audio Cable

Single-Pair Cables



19 • Brilliance® Broadcast

Description	Part No.	UL NEC/ C(UL) CEC Type	No. of Pairs	Color Code	Standard Lengths		Standard Unit Weight		Insulation Thickness		Jacket Thickness		Nominal OD		Nominal Capacitance			
					Ft.	m	Lbs.	kg	Inch	mm	Inch	mm	Inch	mm	* pF/ Ft.	* pF/ m	** pF/ Ft.	** pF/ m

22 AWG Stranded (7x30) TC Conductors • Twisted Pair • Overall Beldfoil® Shield (100% Coverage) • 22 AWG Stranded TC Drain Wire

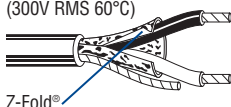
Polyethylene Insulation • Chrome PVC Jacket																						
Low-Capacitance UL AWM Style 2092 (300V RMS 60°C)  Z-Fold®	8761	NEC:	1	Black, Clear	U-500	U-152.4	9.0	4.1	.016	.41	.025	.64	.175	4.45	24	79	47	154				
		CM			500	152.4	9.0	4.1														
		CEC:			U-1000	U-304.8	17.0	7.7														
		CM			1000	304.8	18.0	8.2														
					2000	609.6	36.0	16.3														
					5000	1524.0	90.0	40.9														
	10000††	3048.0	170.0	77.3																		

For Plenum versions of 8761, see 88761, 87761 or 82761.

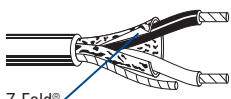
Plenum • FEP Insulation • Red FEP Jacket																				
300V RMS 200°C  Z-Fold®	88761	NEC:	1	Black, Red	100	30.5	2.7	1.2	.006	.15	.014	.36	.119	3.02	35	115	67	220		
		CMP			U-500▲	U-152.4	7.5	3.4												
		CEC:			500†	152.4	7.5	3.4												
		CMP FT6			U-1000▲	U-304.8	15.0	6.8												
					1000†	304.8	12.0	5.4												

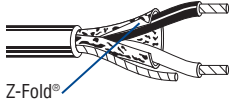
Plenum • FEP Insulation • Red Fluoropolymer Jacket																			
300V RMS 150°C  Z-Fold®	87761	NEC:	1	Black, Red	500†	152.4	7.0	3.2	.006	.15	.014	.36	.116	2.95	35	115	67	220	
		CMP			1000†	304.8	11.0	5.0											
		CEC:																	
		CMP FT6																	

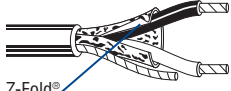
Plenum • FEP Insulation • Natural Flamarrest® Jacket																		
300V RMS 75°C  Z-Fold®	82761	NEC:	1	Black, Red	U-500▲	U-152.4	7.0	3.2	.006	.15	.014	.36	.116	2.95	35	115	67	220
		CMP			U-1000■	U-304.8	14.0	6.4										
		CEC:			1000†	304.8	11.0	5.0										
		CMP FT6																

Polyethylene Insulation • Chrome PVC Jacket																		
Low-Capacitance UL AWM Style 2092 (300V RMS 60°C)  Z-Fold®	9461	NEC:	1	Black, Clear	U-500	U-152.4	11.0	5.0	.016	.41	.026	.66	.180	4.57	24	79	47	154
		CM			U-1000	U-304.8	21.0	9.6										
		CEC:																
		CM																

The jacket and shield are bonded so both can be removed on automatic stripping equipment.

22 AWG Stranded (7x30) Tinned Copper Conductors • Twisted Pair • Tinned Copper Spiral Wrapped Shield (85% Coverage)

PVC Insulation • Chrome PVC Jacket																		
UL AWM Style 2095 (300V RMS 80°C)  Z-Fold®	8737	NEC:	1	Black, Red	U-500	U-152.4	10.5	4.8	.015	.38	.025	.64	.180	4.57	40	131	70	230
		CMG			500	152.4	10.0	4.5										
		CEC:			U-1000	U-304.8	20.0	9.1										
		CMG FT4			1000	304.8	20.0	9.1										

FEP = Fluorinated Ethylene Propylene • TC = Tinned Copper

* Capacitance between conductors.

** Capacitance between one conductor and other conductors connected to shield.

† Spools and/or UnReel® cartons are one piece, but length may vary ±10% for spools and ±5% for UnReel from length shown.

†† Length may vary -10% to +20% and may contain 2 pieces. Minimum length of any piece is 1500 ft.

▲ Length may vary ±10% for UnReel® cartons.

■ Length may vary -10% to +5% from length shown.



Line Level Analog Audio Cable

Double-Pair Cables



Description	Part No.	UL NEC/ C(UL) CEC Type	No. of Pairs	Color Code	Standard Lengths		Standard Unit Weight		Insulation Thickness		Jacket Thickness		Nominal OD		Nominal Capacitance			
					Ft.	m	Lbs.	kg	Inch	mm	Inch	mm	Inch	mm	* pF/ Ft.	* pF/ m	** pF/ Ft.	** pF/ m

22 AWG Stranded (7x30) TC Conductors • Twisted Pairs • Individual Beldfoil® Shield (100% Coverage) • Stranded TC Common Drain Wire

Polypropylene Insulation • Chrome PVC Jacket (Pairs Cabled on Common Axis to Reduce Diameter)

<p>300V RMS 60°C</p>	8723	NEC: 2 Red/Black, Green/White CM	2	Red/Black, Green/White	100	30.5	2.3	1.0	.008	.20	—	—	.160	4.06	35	115	62	203			
		CEC: 500			U-500	U-152.4	10.5	4.8	500	152.4	10.0	4.5	U-1000	U-304.8	20.0	9.1	1000	304.8	20.0	9.1	
		CM			1640	499.9	32.8	14.9	U-2000	U-609.6	38.0	17.2	2000	609.6	40.0	18.2	3280	999.7	65.6	29.8	
					2000	609.6	40.0	18.2	5000	1524.0	95.0	43.2	10000	3048.0	200.0	90.9					

For Plenum versions of 8723, see 88723, 87723 or 82723.

Polypropylene Insulation • Black Low-Smoke, Zero-Halogen Jacket (Pairs Cabled on Common Axis to Reduce Diameter)

<p>LSZH and ABS Type Approved 300V RMS 60°C</p>	8723SB <small>new</small>	NEC: 2 Red & Black, Green & White CMG-LS CEC: CMG-LS FT4 Limited Smoke	2	Red & Black, Green & White	1000	304.8	26.0	11.8	—	—	—	—	.196	4.98	35	115	62	203
---	-------------------------------------	--	---	-------------------------------	------	-------	------	------	---	---	---	---	------	------	----	-----	----	-----

Polypropylene Insulation • Black Low-Smoke, Zero-Halogen Jacket

<p>LSZH and ABS Type Approved 300V RMS</p>	8777SB <small>new</small>	NEC: 3 See Chart 3 CMG-LS CEC: CMG-LS FT4 Limited Smoke (Tech Info Section)	3	See Chart 3 (Tech Info Section)	1000†	304.8	39.0	17.7	.010	.25	—	—	.273	6.93	30	98	55	180
--	-------------------------------------	---	---	------------------------------------	-------	-------	------	------	------	-----	---	---	------	------	----	----	----	-----

Plenum • FEP Insulation • Red FEP Jacket (Pairs Cabled on Common Axis to Reduce Diameter)

<p>300V RMS 200°C</p>	88723	NEC: 2 Red/Black, Green/White CMP CEC: CMP FT6	2	Red/Black, Green/White	100†	30.5	3.4	1.5	.006	.15	—	—	.148	3.76	35	115	67	220
		500†			152.4	11.0	5.0	1000†	304.8	19.0	8.6							

Plenum • FEP Insulation • Red Fluorocopolymer Jacket (Pairs Cabled on Common Axis to Reduce Diameter)

<p>300V RMS 150°C</p>	87723	NEC: 2 Red/Black, Green/White CMP CEC: CMP FT6	2	Red/Black, Green/White	500†	152.4	11.0	5.0	.006	.15	—	—	.148	3.76	35	115	67	220
		1000†			304.8	18.0	8.2											

Plenum • FEP Insulation • Natural Flamarrest® Jacket (Pairs Cabled on Common Axis to Reduce Diameter)

<p>300V RMS 75°C</p>	82723	NEC: 2 Red/Black, Green/White CMP CEC: CMP FT6	2	Red/Black, Green/White	U-500†	U-152.4	10.5	4.8	.006	.15	—	—	.153	3.89	43	141	75	246
		U-1000†			U-304.8	20.0	9.1	1000†	304.8	19.0	8.6							
		U-2000†			U-609.6	40.0	18.1											

FEP = Fluorinated Ethylene Propylene • TC = Tinned Copper

*Capacitance between conductors.

**Capacitance between one conductor and other conductors connected to shield.

† Spools and/or UnReel® cartons are one piece, but length may vary ±10% for spools and ±5% for UnReel from length shown.

Line Level Analog Audio Cable

Single- and Double-Pair Cables



19 • Brilliance® Broadcast

Description	Part No.	UL NEC/ C(UL) CEC Type	No. of Pairs	Color Code	Standard Lengths		Standard Unit Weight		Insulation Thickness		Jacket Thickness		Nominal OD		Nominal Capacitance			
					Ft.	m	Lbs.	kg	Inch	mm	Inch	mm	Inch	mm	* pF/ Ft.	* pF/ m	** pF/ Ft.	** pF/ m

22 AWG Stranded (19x34) TC Conductors • Dual Twisted Pairs • Overall Beldfoil® Shield (100% Coverage) • 24 AWG Stranded TC Drain Wire
PVC Insulation • PVC Jacket in Zip-Cord Construction (Red & Green, Red & Black, Red & Purple or Red & Gray)

	1504A	NEC:	2	Black, Red	U-1000	U-304.8	32.0	14.5	.010	.25	.020	.51	.143	3.63	57	187	100	328		
		CM			2000 ▲	609.8	64.0	29.0												
		CEC: CM														.286	7.26			

*2000 ft. put-up available in Red & Gray or Red & Green only.
 The jacket and shield are bonded so both can be removed on automatic stripping equipment. Drain wire is inside foil shield.

22 AWG Stranded (7x30) TC Conductors • Dual Twisted Pairs • Overall Beldfoil Shield (100% Coverage) • 22 AWG Stranded TC Drain Wire
Polyolefin Insulation • PVC Jacket in Zip-Cord Construction (Red & Green, Red & Gray, Red & Black or Red & Purple)

	9451D	NEC:	2	Black, Red	U-1000	U-304.8	29.0	13.2	.008	.20	.020	.51	.135	3.43	34	112	67	220		
		CMR			2000 *	620.8	62.0	28.1								x	x			
		CEC: CMG FT4														.270	6.86			

*2000 ft. put-up available in Red & Green only.
 The jacket and shield are bonded so both can be removed on automatic stripping equipment. Drain wire is inside foil shield.

Plenum • FEP Insulation • White Flamarrest® Jacket in Zip-Cord Construction

	9451DP <small>new</small>	NEC:	2	Black & Red, Black & White	1000	304.8	24.0	10.9	.007	.18	.017	.43	.127	3.23	35	115	67	220		
		CMP														x	x			
		CEC: CMP FT6														.269	6.83			

The jacket and shield are bonded so both can be removed on automatic stripping equipment. Drain wire is inside foil shield.

20 AWG Stranded (7x28) TC Conductors • Twisted Pair • Overall Beldfoil Shield (100% Coverage) • 20 AWG Stranded TC Drain Wire
PVC Insulation • Beige PVC Jacket

	9154	NEC:	1	Black, Red	U-500	U-152.4	11.5	5.2	.014	.36	.031	.79	.198	5.03	60	197	100	328			
		CMG			500	152.4	12.0	5.5													
		CEC:			U-1000	U-304.8	22.0	10.0													
		CMG FT4			1000	304.8	23.0	10.5													

9154 has 22 AWG stranded tinned copper drain wire.

Polyethylene Insulation • Chrome PVC Jacket

	8762	NEC:	1	Black, Clear	100	30.5	3.2	1.5	.016	.41	.028	.71	.204	5.18	27	89	49	161			
		CM			250	76.2	6.3	2.8													
		CEC:			U-500	U-152.4	12.0	5.5													
		CM			500	152.4	12.0	5.5													
					U-1000	U-304.8	23.0	10.5													

	9464	NEC:	1	Black, Clear	U-500	U-152.4	17.0	7.7	.016	.41	.035	.89	.214	5.44	27	89	49	161		
		CM			U-1000	U-304.8	32.0	14.5												
		CEC: CM																		

The jacket and shield are bonded so both can be removed on automatic stripping equipment. Drain wire is on the inside of foil shield.

20 AWG Stranded (7x28) Tinned Copper Conductors • Twisted Pair • Tinned Copper Spiral Wrapped Shield (89% Coverage)
PVC Insulation • Chrome PVC Jacket

	8759	NEC:	1	Black, Red	U-500	U-152.4	12.5	5.7	.016	.41	.025	.64	.199	5.05	47	154	79	259			
		CMG			U-1000	U-304.8	24.0	10.9													
		CEC:			1000	304.8	25.0	11.4													
		CMG FT4																			

FEP = Fluorinated Ethylene Propylene • TC = Tinned Copper

*Capacitance between conductors.

**Capacitance between one conductor and other conductors connected to shield.



For more information, contact Belden Technical Support: 1-800-BELDEN-1 • www.belden.com

Line Level Analog Audio Cable

Single-Pair Cables



Description	Part No.	UL NEC/ C(UL) CEC Type	No. of Pairs	Color Code	Standard Lengths		Standard Unit Weight		Insulation Thickness		Jacket Thickness		Nominal OD		Nominal Capacitance			
					Ft.	m	Lbs.	kg	Inch	mm	Inch	mm	Inch	mm	* pF/ Ft.	* pF/ m	** pF/ Ft.	** pF/ m

18 AWG Stranded (16x30) TC Conductors • Twisted Pair • Overall Beldfoil® Shield (100% Coverage) • 20 AWG Stranded TC Drain Wire

Polyethylene Insulation • Chrome PVC Jacket

Low-Capacitance UL AWM Style 2092 (300V RMS 60°C)	9460	NEC:	1	Black, Clear	U-500	U-152.4	18.5	8.4	.019	.48	.030	.76	.230	5.84	30	98	44	144			
		CM			U-1000	U-304.8	36.0	16.4													
		CEC:																			
		CM																			



The jacket and shield are bonded so both can be removed on automatic stripping equipment. Drain wire is on the inside of foil shield.

Low-Capacitance UL AWM Style 2092 (300V RMS 60°C)	8760	NEC:	1	Black, Clear	250	76.2	6.8	3.1	.019	.48	.028	.71	.222	5.64	30	98	44	144			
		CM			U-500	U-152.4	13.5	6.1													
		CEC:			500	152.4	13.0	5.9													
		CM			U-1000	U-304.8	25.0	11.3													
					1000	304.8	26.0	11.8													
					2000	609.6	50.0	22.7													
					5000	1524.0	135.0	61.4													
	10000	3048.0	260.0	118.2																	

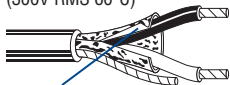

Shorting Fold

For Plenum versions of 8760, see 88760, 87760 or 82760.

18 AWG Stranded (19x30) TC Conductors • Twisted Pair • Overall Beldfoil Shield (100% Coverage) • 20 AWG Stranded TC Drain Wire

Plenum • FEP Insulation • Red FEP Jacket

300V RMS 200°C	88760	NEC:	1	Black, Red	100	30.5	3.7	1.7	.007	.18	.014	.36	.153	3.89	51	167	97	318
		CMP			U-500†	U-152.4	12.5	5.7										
		CEC:			500†	152.4	11.0	5.0										
		CMP FT6			U-1000†	U-304.8	24.0	10.9										
		1000†	304.8	22.0	10.0													



Z-Fold®

Plenum • FEP Insulation • Red Fluorocopolymer Jacket

300V RMS 150°C	87760	NEC:	1	Black, Red	U-500†	U-152.4	12.5	5.7	.007	.18	.014	.36	.150	3.81	51	167	97	318
		CMP			500†	152.4	10.5	4.8										
		CEC:			1000†	304.8	21.0	9.5										
		CMP FT6																



Z-Fold®

Plenum • FEP Insulation • Natural Flamarrest® Jacket

300V RMS 75°C	82760	NEC:	1	Black, Red	U-500†	U-152.4	12.0	5.5	.007	.18	.014	.36	.150	3.81	51	167	97	318
		CMP			U-1000††	U-304.8	22.0	10.0										
		CEC:			1000†	304.8	21.0	9.5										
		CMP FT6																



Z-Fold®

18 AWG Stranded (7x26) Tinned Copper Conductors • Twisted Pair • Tinned Copper Spiral Wrapped Shield (85% Coverage)

PVC Insulation • Chrome PVC Jacket

300V RMS 60°C	8790	NEC:	1	Red, White	U-500	U-152.4	17.5	7.9	.022	.56	.028	.71	.241	6.12	53	174	92	302
		CMG			500	152.4	17.0	7.7										
		CEC:			U-1000	U-304.8	33.0	15.0										
		CMG FT4			1000	304.8	35.0	15.9										



FEP = Fluorinated Ethylene Propylene • TC = Tinned Copper

*Capacitance between conductors.
 **Capacitance between one conductor and other conductors connected to shield.
 † Spools and/or UnReel® cartons are one piece, but length may vary ±10% for spools and ±5% for UnReel from length shown.
 †† Spools and/or UnReel® cartons are one piece, but length may vary -0% to +10%.

Line Level Analog Audio Cable

Single-Pair Cables



19 • Brilliance® Broadcast

Description	Part No.	UL NEC/ C(UL) CEC Type	No. of Pairs	Color Code	Standard Lengths		Standard Unit Weight		Insulation Thickness		Jacket Thickness		Nominal OD		Nominal Capacitance			
					Ft.	m	Lbs.	kg	Inch	mm	Inch	mm	Inch	mm	* pF/ Ft.	* pF/ m	** pF/ Ft.	** pF/ m

16 AWG Stranded (19x29) Tinned Copper Conductors • Twisted Pair • Tinned Copper Spiral Wrapped Shield (85% Coverage)

PVC Insulation • Chrome PVC Jacket																				
	300V RMS 60°C	8780	NEC:	1	Black,	500	152.4	23.5	10.7	.023	.58	.030	.76	.280	7.11	57	187	98	322	
			CMG		White	U-1000	U-304.8	44.0	20.0											
			CEC:			1000	304.8	46.0	20.9											
			CMG FT4																	

16 AWG Stranded (19x29) TC Conductors • Twisted Pair • Overall Beldfoil® Shield (100% Coverage) • 18 AWG Stranded TC Drain Wire

Polyethylene Insulation • Chrome PVC Jacket																				
	Low-Capacitance	8719	NEC:	1	Black,	U-500	U-152.4	24.0	10.9	.032	.81	.032	.81	.313	7.95	23	75	44	144	
	UL AWM Style 20253		CM, CL2		Clear	500	152.4	25.5	11.6											
	(600V RMS 80°C)		CEC:			U-1000	U-304.8	47.0	21.3											
			CM			1000	304.8	50.0	22.7											
						2000	609.6	100.0	45.5											
						5000	1524.0	245.0	111.4											
Shorting Fold					10000 [†]	3048.0	510.0	231.3												

14 AWG Stranded (19x27) TC Conductors • Twisted Pair • Overall Beldfoil Shield (100% Coverage) • 16 AWG Stranded TC Drain Wire

Polyethylene Insulation • Chrome PVC Jacket																				
	Low-Capacitance	8720	NEC:	1	Black,	U-500	U-152.4	34.0	15.4	.032	.81	.035	.89	.355	9.02	24	79	47	154	
	UL AWM Style 20253		CL2		Clear	500	152.4	35.0	15.9											
	(600V RMS 80°C)					1000	304.8	71.0	32.3											
						2000	609.6	138.0	62.7											
	Z-Fold®																			

12 AWG Stranded (19x25) TC Conductors • Twisted Pair • Overall Beldfoil Shield (100% Coverage) • 14 AWG Stranded TC Drain Wire

Polyethylene Insulation • Chrome PVC Jacket																			
	Low-Capacitance	8718	NEC	1	Black,	U-500	U-152.4	47.5	21.6	.037	.94	.040	1.02	.400	10.16	25	82	49	161
	UL AWM Style 20253		CL2		Clear	500	152.4	50.5	22.9										
	(600V RMS 80°C)					1000	304.8	100.0	45.5										
						2000	609.6	198.0	90.0										
Z-Fold®																			

TC = Tinned Copper

*Capacitance between conductors.

**Capacitance between one conductor and other conductors connected to shield.

[†] Final put-up length may vary -10% to +20% from length shown. May contain 2 pieces. Minimum length of any one piece is 1500 ft.

Analog Multi-Pair Snake Cable

High-Flex and NEC Rated Cables



Especially designed for the broadcast industry, Belden's full family of multi-pair audio "Snake" cables feature options and construction for virtually every application.

Applications

Snake cables are used to connect multiple audio channels in low-level (microphone) and high-level (line) componentry such as console board equipment for recording studios, radio television stations, post-production facilities, and sound system installations. With Belden's individually shielded and jacketed snakes, pairs can be split out of the overall jacket for any length and connectorized directly without the need for heat shrink tubing or costly and time-consuming preparation. 22 AWG and 24 AWG sizes are also ideal for punch down connector applications.

Numbered and Color Coded

Jacketed pairs are individually numbered and color coded (following the familiar resistor color code) for easy identification.

Low-Capacitance Design

Belden's 1200 Series Snake Cables feature a low-capacitance design in a flexible, high-performance construction.

New "French Braid" Shield

Belden's patented "French Braid" shield is a double spiral (double serve) bare copper shield with the two spirals tied together by one weave. This improves flex life over standard spiral shields, improves flexibility over conventional braid shields, and lowers microphonic or triboelectric noise.

The "French Braid" is easy to terminate since it is not fully woven. It also provides for lower DC loop resistance than a single spiral braid. The "French Braid" is featured on Belden's FleXsnake® Cables (1900 Series) and Quad Snake Cables (7880 Series).

How to Choose a Snake Cable

Permanent Installations

For installed jobs, where you must have an NEC rating, choose your preferred pair-count from within one of the following Belden® snake cable series:

1400R Series Page 19.19

CMR Rated
24 AWG
Individually Shielded and Jacketed Pairs

1500C Series Page 19.20

Flexible, CM Rated
24 AWG
Individually Shielded and Jacketed Pairs

1800R Series Page 19.22

CMR Rated
22 AWG
Individually Shielded and Jacketed Pairs

8769-8778/9767-9769 Series Page 19.24

CM Rated
22 AWG
Individually Shielded Pairs

80000 Series Page 19.25

CMP Rated (Plenum-Rated)
22 AWG
Individually Shielded Pairs

6540PA Series Page 19.26

CMP Rated (Plenum-Rated)
22 AWG
Individually Shielded Pairs

Temporary Installations or Field Use

For non-installed jobs, where cable flexibility is more important than NEC rating, choose your preferred pair-count from these snake cables series:

1500C Series Page 19.20

Flexible, CM Rated
24 AWG
Individually Shielded and Jacketed Pairs

1200B Series Page 19.23

Flexible, Low-Capacitance
22 AWG
Individually Shielded and Jacketed Pairs

1900A Series Page 19.21

Super-Flexible
24 AWG
Individually Shielded and Jacketed Pairs with "French Braid" Shield

7880A Series Page 19.18

Super-Flexible Star Quads
26 AWG
Individually Shielded and Jacketed Quads with "French Braid" Shield

For AES/EBU Digital Multi-Snake Cables
See Pages 19.28 -19.30

Analog Multi-Quad Snake Cable

Super-Flexible, High-Performance Cables
Individually Shielded and Jacketed Quads



Individually Shielded and Jacketed Quads

Not NEC Rated

Product Description

26 AWG* stranded (19x38) bare copper conductor. Polyethylene insulation. Quads individually shielded with bare copper "French Braid," each quad with 26 AWG tinned copper drain wire. Color-coded PVC inner jackets (see table below) with overall Matte Black PVC jacket and 20 AWG tinned copper drain wire.

Color Code: Blue, White, Blue w/White stripe, White w/Blue stripe.

Specifications

Nominal OD — Conductor	.020" (.51mm)
Nominal OD — Insulation	.045" (1.14mm)
Inner Quad Jacket OD	.157" (3.99mm)
Nominal DCR	
Conductor	36.0 Ω/M' (11.8 Ω/km)
Shield (Inner Pair)	6.8 Ω/M' (2.23 Ω/km)
Voltage Rating	100V RMS
Temperature Rating	60°C
Nominal Impedance	40Ω
Nominal Velocity of Propagation	66%
Nominal Capacitance	
Between Conductors and Shield	39 pF/Ft. (129 pF/m)
Between Conductors in Quad Config.	57 pF/Ft. (188 pF/m)

DCR = DC Resistance

*22 AWG equivalent DCR when connected to a 3-pin XLR

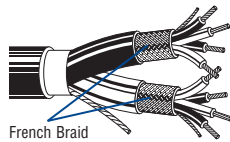

French Braid

Part No.	No. of Quads	Standard Lengths		Standard Unit Weight		Nominal OD	
		Ft.	m	Lbs.	kg	Inch	mm

Super-Flexible Quads

26 AWG							
7884A	2	250	76.2	27.0	12.3	.458	11.63
		500 [†]	152.4	49.0	22.2		
		1000 [†]	304.8	98.0	44.4		
7885A	4	250	76.2	36.3	16.4	.498	12.65
		500 [†]	152.4	70.0	31.8		
		1000 [†]	304.8	136.0	61.7		
7886A	8	500 [†]	152.4	146.5	66.6	.782	19.86
		1000 [†]	304.8	314.0	142.4		
7887A	12	250	76.2	89.5	40.6	.828	21.03
		500 [†]	152.4	177.5	80.5		
		1000 [†]	304.8	365.0	165.6		
7888A	16	250	76.2	114.0	51.7	.938	23.83
		500 [†]	152.4	238.5	108.2		
		1000 [†]	304.8	468.0	212.3		
7889A	24	500 [†]	152.4	396.0	180.0	1.232	31.29
		1000 [†]	304.8	798.0	362.0		

[†]Length may vary -10% to +0% from length shown.

Inner Jacket Colors:

Quad No.	Jacket Color	Quad No.	Jacket Color
1	Brown	8	Gray
2	Red	9	White
3	Orange	10	Black
4	Yellow	11	Beige
5	Green	12	Pink
6	Blue	13-24	Gray (numbered)
7	Purple		

Analog Multi-Pair Snake Cable

CMR Rated Cables

Individually Shielded and Jacketed Twisted Pairs



Individually Shielded and Jacketed Pairs

NEC: CMR (CEC: CMG FT4)

Product Description

24 AWG stranded (7x30) tinned copper conductor. Polyolefin insulation. Twisted pairs individual Beldfoil® shield (100% Coverage) and have numbered and color-coded PVC jackets (see Chart 7 in Technical Information Section for colors). Pair jackets and shields are bonded so both strip simultaneously with automatic stripping equipment. Overall Beldfoil shield and 18 AWG tinned copper drain wire, plus overall Black PVC jacket and nylon rip cord.

Color Code: Red, Black.

Specifications

Nominal OD — Conductor	.024" (.61mm)
Nominal OD — Insulation	.040" (1.02mm)
Inner Pair Jacket OD	.111" (2.82mm)
Approvals	
NEC	CMR
CEC	CMG FT4
Nominal DCR	
Conductor	23.3Ω/M' (76.4Ω/km)
Shield (Inner Pair)	15.9Ω/M' (52.1Ω/km)
Voltage Rating	300V RMS
Temperature Rating	75°C
Nominal Impedance	50Ω
Nominal Velocity of Propagation	66%
Nominal Capacitance	
Between Conductors	31 pF/Ft. (102 pF/m)
Between Conductor/Shield*	58 pF/Ft. (191 pF/m)

DCR = DC Resistance

*Capacitance between one conductor and other conductors connected to shield.

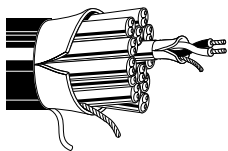

Part No.	No. of Pairs	Standard Lengths		Standard Unit Weight		Nominal OD	
		Ft.	m	Lbs.	kg	Inch	mm

CMR Rated Twisted Pairs NEC: CMR (CEC: CMG FT4)

24 AWG							
1408R	4	500	152.4	36.0	16.3	.346	8.79
		1000	304.8	73.0	33.2		
1409R	6	500	152.4	50.5	22.9	.412	10.46
		1000	304.8	100.0	45.4		
1410R	8	500	152.4	62.0	28.1	.446	11.33
		1000	304.8	122.0	55.3		
1411R	12	500	152.4	91.0	41.3	.555	14.10
		1000	304.8	175.0	79.4		
1412R	16	500	152.4	117.0	53.1	.622	15.80
		1000	304.8	232.0	105.2		
1413R	20	500	152.4	145.0	65.8	.704	17.88
		1000	304.8	293.0	132.9		
1414R	24	500	152.4	182.0	82.6	.801	20.35
		1000	304.8	374.0	169.6		
1415R	26	500	152.4	193.5	87.8	.816	20.73
		1000	304.8	397.0	180.1		
1416R	32	500	152.4	228.5	103.7	.890	22.61
		1000	304.8	465.0	210.9		

Analog Multi-Pair Snake Cable

Flexible, CM Rated Cables

Individually Shielded and Jacketed Twisted Pairs



Individually Shielded and Jacketed Pairs

NEC: CM (CEC: CM)

Product Description

24 AWG stranded (7x32) tinned copper conductor. Polyolefin insulation. Twisted pairs individual Beldfoil® shield (100% coverage) and have numbered and color-coded PVC jackets (see Chart 7 in Technical Information Section for colors). Jackets and shields are bonded so both strip simultaneously. Overall Beldfoil shield and 24 AWG tinned copper drain wire, plus overall Matte Black PVC jacket and nylon rip cord.

Color Code: Red, Black.

Specifications

Nominal OD — Conductor	.024" (.61mm)
Nominal OD — Insulation	.040" (1.02mm)
Inner Pair Jacket OD	.111" (2.82mm)
Approvals	
NEC	CM
CEC	CM
Nominal DCR	
Conductor	23.3Ω/M' (76.4Ω/km)
Shield (Inner Pair)	15.9Ω/M' (52.2Ω/km)
Voltage Rating	300V RMS
Temperature Rating	75°C
Nominal Impedance	50Ω
Nominal Velocity of Propagation	66%
Nominal Capacitance	
Between Conductors	31 pF/Ft. (102 pF/m)
Between Conductor/Shield*	58 pF/Ft. (191 pF/m)

DCR = DC Resistance

*Capacitance between one conductor and other conductors connected to shield.

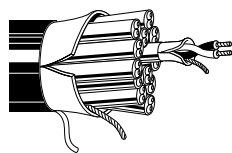

Part No.	No. of Pairs	Standard Lengths		Standard Unit Weight		Nominal OD	
		Ft.	m	Lbs.	kg	Inch	mm

Flexible, CM Rated Twisted Pairs NEC: CM (CEC: CM)

24 AWG							
1509C	2	500	152.4	24.0	10.9	.301	7.65
		1000	304.8	46.0	20.9		
1510C	4	500	152.4	35.5	16.1	.352	8.94
		1000	304.8	72.0	32.6		
1511C	6	500	152.4	52.0	23.6	.418	10.61
		1000	304.8	102.0	46.3		
1512C	8	500	152.4	65.5	29.7	.452	11.48
		1000	304.8	124.0	56.3		
1513C (DT-12)	12	500	152.4	89.5	40.6	.561	14.25
		1000	304.8	178.0	80.7		
1514C	16	500	152.4	122.5	55.6	.628	15.95
		1000	304.8	241.0	109.3		
1515C	20	500	152.4	142.5	64.6	.710	19.56
		1000	304.8	288.0	130.6		
1516C	24	500	152.4	180.5	81.9	.807	20.50
		1000	304.8	371.0	168.3		
1517C	26	500	152.4	187.5	85.1	.823	20.90
		1000	304.8	385.0	174.6		
1518C	32	500	152.4	236.5	107.3	.897	22.78
		1000	304.8	481.0	218.2		
1519C	52	500	152.4	372.5	169.0	1.117	28.37
		1000	304.8	731.0	331.6		

Analog Multi-Pair Snake Cable

FlexSnake® Super-Flexible, High-Performance Cables
Individually Shielded and Jacketed Twisted Pairs



Individually Shielded and Jacketed Pairs

Not NEC Rated

Product Description

24 AWG stranded (41x40) bare copper conductor. Polyolefin insulation. Twisted pairs individually shielded with double serve "French Braid" (93% coverage) with tinned copper drain wire. Pairs have numbered and color-coded PVC jackets (see Chart 7 in Technical Information Section for colors). Overall Black PVC jacket.

Color Code: Red, Black.

Specifications

Nominal OD — Conductor	.023" (.58mm)
Nominal OD — Insulation	.040" (1.02mm)
Inner Pair Jacket OD	.119" (3.02mm)
Nominal DCR	
Conductor	25.5Ω/M' (83.7Ω/km)
Shield (Inner Pair)	7.2Ω/M' (23.6Ω/km)
Voltage Rating	300V RMS
Temperature Rating	60°C
Nominal Impedance	60Ω
Nominal Velocity of Propagation	66%
Nominal Capacitance	
Between Conductors	26 pF/Ft. (85 pF/m)
Between Conductor/Shield*	47 pF/Ft. (154 pF/m)

DCR = DC Resistance

*Capacitance between one conductor and other conductors connected to shield.

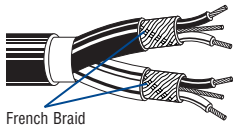

French Braid

Part No.	No. of Pairs	Standard Lengths		Standard Unit Weight		Nominal OD	
		Ft.	m	Lbs.	kg	Inch	mm

FlexSnake Super-Flexible Twisted Pairs

24 AWG							
1902A	2	250	76.2	12.0	5.5	.330	8.38
		500 †	152.4	27.5	12.5		
		1000 †	304.8	53.0	24.1		
1904A	4	250	76.2	19.8	9.0	.372	8.45
		500 †	152.4	40.5	18.4		
		1000 †	304.8	78.0	35.5		
1906A	6	250	76.2	28.5	12.9	.449	11.40
		500 †	152.4	55.5	25.2		
		1000 †	304.8	111.0	50.5		
1908A	8	250	76.2	36.0	16.3	.482	12.20
		500 †	152.4	72.5	32.9		
		1000 †	304.8	141.0	64.0		
1912A	12	250	76.2	51.8	23.5	.602	15.30
		500 †	152.4	102.5	46.6		
		1000 †	304.8	202.0	91.6		
1916A	16	250	76.2	71.0	32.2	.683	17.30
		500 †	152.4	138.0	62.7		
		1000 †	304.8	279.0	126.6		
1924A	24	250	76.2	108.0	49.0	.825	21.00
		500 †	152.4	214.5	97.3		
		1000 †	304.8	437.0	198.2		
1932A	32	250	76.2	135.3	61.4	.968	24.60
		500 †	152.4	274.0	124.3		
		1000 †	304.8	539.0	244.5		

†Length may vary -10% to +0% from length shown.

Analog Multi-Pair Snake Cable

CMR Rated Cables

Individually Shielded and Jacketed Twisted Pairs



Individually Shielded and Jacketed Pairs

NEC: CMR (CEC: CMG FT4)

Product Description

22 AWG stranded (7x30) tinned copper conductor. Polyolefin insulation. Twisted pairs individual bonded Beldfoil® shield and have numbered and color-coded PVC jackets (see Chart 7 in Technical Information Section for colors). Jackets and shields are bonded so both strip simultaneously. Overall Beldfoil shield plus overall Black PVC jacket and nylon rip cord.

Color Code: Red, Black.

Specifications

Nominal OD — Conductor	.030" (.76mm)
Nominal OD — Insulation	.050" (1.27mm)
Drain Wire	
Individual Pairs	22 AWG
Overall: 1814R	22 AWG
Overall: 1815R – 1823R	18 AWG
Inner Pair Jacket OD	.133" (3.38mm)
Approvals	
NEC	CMR
CEC	CMG FT4
Nominal DCR	
Conductor	14.8Ω/M' (52.5Ω/km)
Shield (Inner Pair)	14.1Ω/M' (46.3Ω/km)
Voltage Rating	300V RMS
Temperature Rating	60°C
Nominal Impedance	50Ω
Nominal Velocity of Propagation	66%
Nominal Capacitance	
Between Conductors	31 pF/Ft. (102 pF/m)
Between Conductor/Shield*	56 pF/Ft. (184 pF/m)

DCR = DC Resistance

*Capacitance between one conductor and other conductors connected to shield.

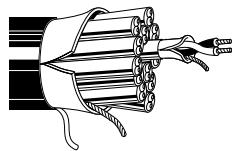

Part No.	No. of Pairs	Standard Lengths		Standard Unit Weight		Nominal OD	
		Ft.	m	Lbs.	kg	Inch	mm

CMR Rated Twisted Pairs NEC: CMR (CEC: CMG FT4)

22 AWG							
1814R	2	500	152.4	30.0	13.6	.330	8.38
		1000	304.8	59.0	26.8		
1815R	4	500	152.4	45.0	20.4	.384	9.74
		1000	304.8	91.0	41.3		
1816R	6	500	152.4	65.0	29.5	.462	11.73
		1000	304.8	131.0	59.6		
1817R	8	500	152.4	80.0	36.3	.503	12.78
		1000	304.8	152.0	68.9		
1818R	12	500	152.4	121.0	54.9	.638	16.21
		1000	304.8	241.0	109.3		
1819R	16	500	152.4	180.0	81.6	.776	19.71
		1000	304.8	364.0	165.0		
1820R	20	500	152.4	216.0	98.0	.865	21.97
		1000	304.8	442.0	200.1		
1821R	24	500	152.4	263.5	119.5	.969	24.61
		1000	304.8	518.0	235.0		
1822R	26	500	152.4	280.5	127.2	.989	25.12
		1000	304.8	552.0	250.4		
1823R	32	500	152.4	335.5	152.2	1.072	27.23
		1000	304.8	692.0	313.9		

Length may vary -10% to +0% from length shown.

Analog Multi-Pair Snake Cable

Flexible, Low-Capacitance Cables

Individually Shielded and Jacketed Twisted Pairs



Individually Shielded and Jacketed Pairs

Not NEC Rated

Product Description

22 AWG stranded (7x30) tinned copper conductor. Datalene® insulation. Twisted pairs individual Beldfoil® shield (100% Coverage) and have numbered and color-coded PVC jackets (see Chart 7 in Technical Information Section for colors). Pair jackets and shields are bonded so both strip simultaneously with automatic stripping equipment. Overall Matte Black PVC jacket and nylon rip cord.

Datalene insulation features include a low dielectric constant and a low dissipation factor for high-speed, low-distortion data handling. Physical properties include good crush resistance and light weight.

Color Code: Red, Black.

Specifications

Nominal OD — Conductor	.030" (.76mm)
Nominal OD — Insulation	.060" (1.52mm)
Inner Pair Jacket OD	.153" (3.89mm)
Nominal DCR	
Conductor	15.0Ω/M' (52.5Ω/km)
Shield (Inner Pair)	10.6Ω/M' (34.8Ω/km)
Voltage Rating	150V RMS
Temperature Rating	60°C
Nominal Impedance	70Ω
Nominal Velocity of Propagation	78%
Nominal Capacitance	
Between Conductors	19 pF/Ft. (62 pF/m)
Between Conductor/Shield*	35 pF/Ft. (115 pF/m)

DCR = DC Resistance

*Capacitance between one conductor and other conductors connected to shield.

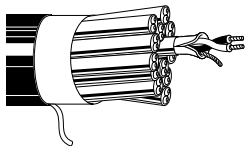

Part No.	No. of Pairs	Standard Lengths		Standard Unit Weight		Nominal OD	
		Ft.	m	Lbs.	kg	Inch	mm

Flexible, Low-Capacitance Twisted Pairs

22 AWG							
1217B	4	500	152.4	53.0	24.0	.458	11.63
		1000	304.8	107.0	48.5		
1218B	6	500	152.4	79.5	36.1	.578	14.68
		1000	304.8	152.0	68.9		
1219B	9	500	152.4	115.5	52.4	.700	17.78
		1000	304.8	234.0	106.1		
1220B	12	500	152.4	141.0	70.0	.760	19.30
		1000	304.8	286.0	129.7		
1222B	16	500	152.4	188.0	85.3	.852	21.64
		1000	304.8	384.0	174.2		
1225B	20	500	152.4	240.0	108.8	.960	24.38
		1000	304.8	471.0	213.6		
1427B	24	1000	304.8	588.0	266.7	1.088	27.64
1221B	28	500	152.4	335.0	152.0	1.140	28.96
		1000	304.8	676.0	306.6		
1226B	32	500	152.4	369.0	167.4	1.183	30.05
		1000	304.8	744.0	337.5		
1428B†	52	1000	304.8	1141.0	517.5	1.496	38.00

†1428B available by special order. Please contact Belden for lead time.

Analog Multi-Pair Snake Cable

CM Rated Cables
Individually Shielded Twisted Pairs



Individually Shielded Pairs

NEC: CM (CEC: CM)

Product Description

22 AWG stranded (7x30) tinned copper conductors. Polypropylene insulation. Twisted pairs individually Beldfoil® shielded (100% Coverage). Overall Chrome PVC jacket and 22 AWG stranded tinned copper drain wire.

Color Code: See Chart 3 (in Technical Information Section)

Specifications

Nominal OD — Conductor	.030" (.76mm)
Nominal OD — Insulation	.050" (1.27mm)

Approvals	
NEC	CM
CEC	CM

UL Ratings	UL AWM Style 2919
-------------------	-------------------

Voltage Rating	30V RMS
-----------------------	---------

Temperature Rating	80°C
---------------------------	------

Nominal DCR	
Conductor	15.0Ω/M' (52.5Ω/km)
Shield	10.6Ω/M' (34.8Ω/km)

Nominal Impedance	50Ω
--------------------------	-----

Nominal Velocity of Propagation	66%
--	-----

Nominal Capacitance	
Between Conductors	30 pF/Ft. (98 pF/m)
Between Conductor/Shield*	55 pF/Ft. (180 pF/m)

DCR = DC Resistance

*Capacitance between one conductor and other conductors connected to shield.

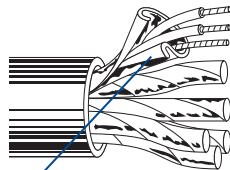

Z-Fold®

Part No.	No. of Pairs	Standard Lengths		Standard Unit Weight		Nominal OD	
		Ft.	m	Lbs.	kg	Inch	mm

CM Rated Twisted Pairs NEC: CM (CEC: CM)

22 AWG							
8777	3	100	30.5	4.7	2.1	.273	6.93
		250	76.2	10.0	4.5		
		U-500	U-152.4	21.0	9.5		
		500	152.4	20.0	9.1		
		U-1000	U-304.8	41.0	18.6		
		1000	304.8	44.0	20.0		
		1640	499.9	70.5	32.0		
		3280	999.7	141.0	64.0		
		5000	1524.0	215.0	97.5		
		10000†	3048.0	460.0	208.7		

For Plenum versions of 8777, see 88777, 87777 or 82777.

8778	6	100	30.5	8.4	3.8	.362	9.19
		250	76.2	19.0	8.6		
		500	152.4	43.0	19.5		
		1000	304.8	83.0	37.7		

For Plenum versions of 8778, see 88778, 87778 or 82778.

8774	9	100	30.5	11.5	5.2	.417	10.59
		250	76.2	29.5	13.4		
		500	152.4	57.5	26.1		
		1000	304.8	113.0	51.3		

8775	11	100	30.5	12.1	5.5	.464	11.79
		500	152.4	65.5	29.7		
		1000	304.8	130.0	59.0		

9768	12	100	30.5	13.2	6.0	.464	11.79
		250	76.2	36.5	16.6		
		500	152.4	73.5	33.4		
		1000	304.8	143.0	65.0		

8776	15	100	30.5	17.8	8.1	.548	13.92
		250	76.2	49.5	22.5		
		500	152.4	98.0	44.5		
		1000	304.8	197.0	89.5		

9769	17	100	30.5	20.0	9.1	.577	14.66
		500	152.4	109.0	49.5		
		1000	304.8	215.0	97.7		

8769	19	100	30.5	22.9	10.4	.603	15.32
		500	152.4	123.0	55.8		
		1000	304.8	244.0	110.7		

8773	27	100	30.5	33.9	15.4	.709	18.00
		250	76.2	83.8	38.0		
		500	152.4	163.0	73.9		
		1000	304.8	341.0	154.7		

9767	37	500††	152.4	224.0	101.8	.800	20.32
		1000††	304.8	481.0	218.6		

† Final put-ups may vary -10 to +20% from length shown, and may contain 2 pieces.

Minimum length of any one piece will be 1500 ft.

†† Spools are one piece, but length may vary -0 to +20% from length shown.

Analog Multi-Pair Snake Cable

CMP Rated (Plenum) Cables
Individually Shielded Twisted Pairs



Individually Shielded Pairs

NEC: CMP (CEC: CMP FT6)

Product Description

22 AWG stranded (7x30) tinned copper conductors. FEP insulation. Twisted pairs individually Beldfoil® shielded (100% Coverage). Overall jacket per table below. 22 AWG stranded tinned copper drain wire.

Color Code: See Chart 3 (in Technical Information Section)

Specifications

Nominal OD — Conductor .030" (.76mm)

Nominal OD — Insulation .050" (1.27mm)

Overall Jacket

88000 Series FEP
87000 Series PVDF
82000 Series Flamarrest®

Approvals

NEC CMP
CEC CMP FT6

UL Ratings

Non-conduit

Voltage Rating

300V RMS

Temperature Rating

88000 Series 200°C
87000 Series 150°C
82000 Series 60°C

Nominal DCR

Conductor 16.0Ω/M' (52.5Ω/km)
Shield 11.3Ω/M' (37.1Ω/km)

Nominal Impedance

82000 Series 46Ω
87000, 88000 Series 50Ω

Nominal Velocity of Propagation

82000 Series 62%
87000, 88000 Series 69%

Nominal Capacitance (82000 Series)

Between Conductors 35 pF/Ft. (115 pF/m)
Between Conductor/Shield* 76 pF/Ft. (249 pF/m)

Nominal Capacitance (87000, 88000 Series)

Between Conductors 31 pF/Ft. (102 pF/m)
Between Conductor/Shield* 67 pF/Ft. (220 pF/m)

DCR = DC Resistance • FEP = Fluorinated Ethylene Propylene

*Capacitance between one conductor and other conductors connected to shield.

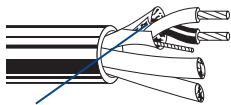

Z-Fold®

Part No.	No. of Pairs	Standard Lengths		Standard Unit Weight		Nominal OD	
		Ft.	m	Lbs.	kg	Inch	mm

Plenum-Rated Twisted Pairs NEC: CMP (CEC: CMP FT6)

22 AWG							
88777	3	100	30.5	6.0	2.7	.234	5.94
		500†	152.4	19.0	8.6		
		1000†	304.8	42.0	19.1		
88778	6	100	30.5	7.0	3.2	.309	7.85
		500†	152.4	38.5	17.5		
		1000†	304.8	75.0	34.1		
87777	3	500†	152.4	18.0	8.2	.234	5.94
		1000†	304.8	40.0	18.2		
87778	6	500†	152.4	37.5	17.0	.309	7.85
		1000†	304.8	73.0	33.2		
82777	3	U-500†	U-152.4	19.5	8.9	.237	6.02
		U-1000	U-304.8	38.0	17.3		
		1000†	304.8	39.0	17.7		
82778	6	1000†	304.8	71.0	32.2	.314	7.98

†Spools and/or UnReel® cartons are one piece, but length may vary ±10% for spools and UnReel U-500 and -10% to +5% for UnReel U-1000 from length shown.

Analog Multi-Pair Snake Cable

CMP Rated (Plenum) Cables
Individually Shielded Twisted Pairs



Individually Shielded Pairs

NEC: CMP (CEC: CMP FT6)

Product Description

22 AWG stranded (7x30) bare copper conductor. FEP insulation. Twisted pairs individual Beldfoil® shield (100% Coverage) with drain wire. Multiple pairs cable together. Overall Gray fluorocopolymer jacket and rip cord. Sequential footage marking every two feet.

Color Code: See Chart 3 (in Technical Information Section)

Specifications

Nominal OD — Conductor	.029" (.74mm)
Nominal OD — Insulation	.049" (1.24mm)
Insulation Thickness	.010" (.254mm)
Shield	Beldfoil
Outer Jacket Thickness	
2- to 12-pair	.015" (.38mm)
16-pair (6549PA)	.018" (.46mm)
Approvals	
NEC	CMP
CEC	CMP FT6
Voltage Rating	300V
Temperature Rating	75°C
Nominal DCR	
Conductor	16.4Ω/M' (53.8Ω/km)
Shield	15.3Ω/M' (50.2Ω/km)
Nominal Impedance	50Ω
Nominal Velocity of Propagation	69%
Nominal Capacitance	27.5 pF/Ft. (90.2 pF/m)

DCR = DC Resistance • FEP = Fluorinated Ethylene Propylene

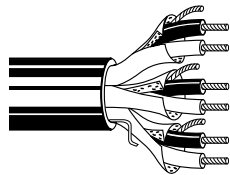

Part No.	No. of Pairs	Standard Lengths		Standard Unit Weight		Nominal OD	
		Ft.	m	Lbs.	kg	Inch	mm

Plenum-Rated Twisted Pairs NEC: CMP (CEC: CMP FT6)

22 AWG							
6541PA	2	500	152	13.5	6.1	.214	5.44
		U-1000	U-305	26.0	11.8		
		1000	305	27.0	12.2		
6542PA	3	1000	305	36.0	16.4	.228	5.79
6543PA	4	1000	305	45.0	20.4	.252	6.40
6545PA	6	1000	305	60.0	27.2	.300	7.62
6546PA	8	1000	305	85.0	38.6	.332	8.43
6548PA	12	1000	305	125.0	56.7	.408	10.36
6549PA	16	1000	305	162.0	73.5	.457	11.61

AES/EBU Digital Audio Cable

Overview



While digital audio has been around for over 25 years, only recently has there been an effort to standardize specifications. The Audio Engineering Society (U.S.) and the European Broadcast Union have established an international standard, called AES/EBU. The detailed specifications of this standard are:

Sampling Rate: from 32 KHz to 192 KHz
Bandwidth: from 4.096 MHz to 24.5 MHz
Impedance: 110Ω ± 20%

The key difference between twisted pair specifications for digital audio cable and standard analog audio cable is the impedance specification.

AES/EBU, with its broad tolerance, allows cables with impedances from 88 ohms to 132 ohms to be used. Standard analog audio cable impedance is 45 ohms to 70 ohms. This potential amount of mismatch can result in signal reflections and jitter, causing bit errors at the receiver. For this reason Belden recommends 100 to 120 ohm shielded twisted pair cable.

Product Characteristics

Belden's product offering includes 110 ohm cable solutions and an entire line of single and multi-pair snake cable designed specifically for digital audio. These cables utilize Datalene® premium grade high density insulation. This provides exceptional crush resistance as compared to standard foam polyethylenes, making the new cables less susceptible to damage resulting from cable pulling or flexing. The high velocity of propagation further reduces capacitance and signal delay providing error-free transmissions over extended distances.

Belden's "Super Flexible" digital patch cable, part no. 1800F, utilizes Belden's patented "French Braid" shield technology and a special jacket compound formulation to provide the ultimate in flexibility and performance.

Digital Audio Attenuation

Part Number	2 MHz		4 MHz		5 MHz		6 MHz		12 MHz		25 MHz	
	dB/100 Ft.	dB/100m	dB/100 Ft.	dB/100m	dB/100 Ft.	dB/100m	dB/100 Ft.	dB/100m	dB/100 Ft.	dB/100m	dB/100 Ft.	dB/100m
9180, 7880A Series	1.67	5.48	2.11	6.92	2.30	7.55	2.46	8.07	3.16	10.37	4.22	13.85
1800F	1.28	4.20	2.17	7.12	2.62	8.60	3.01	9.88	4.72	15.49	7.17	23.52
1800B, 1801B, 1802B, 1803F Series	1.30	4.27	1.56	5.12	1.70	5.58	1.81	5.94	2.28	7.48	3.08	10.10
1696A	.93	3.05	1.15	3.77	1.20	3.94	1.30	4.27	1.60	5.25	1.97	6.46
179DT (coax)	1.34	4.40	1.67	5.48	1.74	5.71	1.99	6.53	2.77	9.09	3.83	12.57
1855A (coax)	.57	1.86	.82	2.70	.92	3.02	1.00	3.29	1.30	4.27	1.80	5.91
1505A (coax)	.41	1.35	.58	1.89	.63	2.07	.69	2.25	.90	2.95	1.30	4.27
1505F (coax)	.34	1.11	.53	1.74	.60	1.97	.67	2.20	.98	3.22	1.44	4.72
1694A (coax)	.16	.52	.48	1.57	.54	1.77	.59	1.93	.80	2.62	1.00	3.28

Values reflect typical results.

Maximum Recommended Transmission Distance at Digital Audio Data Rates (AES3-2003)*

Part Number	2 MHz		4 MHz		5 MHz		6 MHz		12 MHz		25 MHz	
	Ft.	m	Ft.	m	Ft.	m	Ft.	m	Ft.	m	Ft.	m
9180, 7880A Series	1198	365	948	289	870	265	813	248	633	193	474	144
7731A Series	8889	2709	6349	1935	5882	1793	5479	1670	3774	1150	2817	859
1800F	1563	476	922	281	763	233	664	203	424	129	279	85
1800B, 1801B, 1802B, 1803F Series	1538	469	1282	391	1176	359	1105	337	877	267	649	198
1696A	2151	655	1739	530	1667	508	1538	469	1250	381	1015	309
179DT (AES3)†♦	1493	455	1198	365	1149	350	1005	306	722	220	522	159
(AES-3id)††	597	182	479	146	460	140	402	123	289	88	209	64
1855A (AES3)†♦	3521	1073	2427	740	2174	663	1992	607	1538	469	1111	339
(AES-3id)††	1408	429	970	295	869	265	796	242	615	188	444	135
1505A (AES3)†♦	4866	1483	3478	1060	3175	968	2911	887	2222	677	1538	469
(AES-3id)††	1946	593	1391	424	1270	387	1164	355	888	270	615	188
1505F (AES3)†♦	5882	1793	3774	1150	3333	1016	2985	910	2041	622	1389	423
(AES-3id)††	2353	717	1509	460	1333	406	1194	364	816	249	556	169
1694A (AES3)†♦	5882	1793	4184	1275	3704	1129	3407	1039	2500	762	2000	610
(AES-3id)††	2353	717	1673	510	1482	452	1363	416	1000	305	800	244

* Longer transmission distances are achievable but are contingent upon system component quality of input/output voltages.

† Transmission distance calculations assume minimum allowable output signal amplitude (2V per AES3-2003) and minimum allowable input signal amplitude (200mV per AES3-2003).

†† Per AES-3id-2001, when using analog video distribution equipment to implement AES-3id, maximum transmission distances are 40% of AES3 values assuming a minimum allowable output signal amplitude of 1V and a minimum allowable input signal amplitude of 320mV.

♦ Implementation of AES3 with coaxial cable and 110-75Ω baluns can be achieved with transmission distances of 91% of the AES3 coaxial distances listed above.

AES/EBU Digital Audio Cable

Single- and Double-Pair Cables



19 • Brilliance® Broadcast

Description	Part No.	UL NEC/ C(UL) CEC Type	No. of Pairs	Color Code	Standard Lengths		Standard Unit Weight		Nom. DCR		Nominal OD		Nom. Imp. (Ω)	Nom. Vel. of Prop.	Nom. Capacitance			
					Ft.	m	Lbs.	kg	Cond.	Shield	Inch	mm			* pF/ Ft.	* pF/ m	** pF/ Ft.	** pF/ m

110 Ohm • 26 AWG Stranded (7x34) .018" TC Conductors • Twisted Pair • Beldfoil® Shield (100% Coverage) • 26 AWG Stranded TC Drain Wire
Datalene® Insulation • Chrome or Purple PVC Jacket

2-Conductor Digital Video Time Code Cable 75°C	9180	NEC: CMR CEC: CMG FT4	1	Black, White	1000	304.8	10.0	4.5	37.3Ω/M'	23.1Ω/M'	.144	3.66	110	76%	13	43	26	85
---	-------------	--------------------------	---	--------------	------	-------	------	-----	----------	----------	------	------	-----	-----	----	----	----	----



Shorting Fold

For cross-connect use with 7891A (et al.) Digital Audio Snake Cables, see page 19.28.

24 AWG Stranded (7x32) Tinned Copper Conductors • Twisted Pairs • Overall Beldfoil Shield (100% Coverage) • 24 AWG Drain Wire
Datalene Insulation • Gray or Purple PVC Jacket

60°C	1800B	NEC: CMR CEC: CMG FT4	1	Black, Red	500*	152.4	8.0	3.6	23.7Ω/M'	18.9Ω/M'	.177	4.57	110	76%	12	39	26	85
					U-1000	U-304.8	17.0	7.7	77.7Ω/km	62.0Ω/km								
					1000	304.8	16.0	7.3										
					5000*	1524.0	90.0	40.8										



For cross-connect use with 1803F (et al.) Digital Audio Snake Cables, see page 19.28.
 For Plenum version of 1800B, see 1801B.

*500 ft. put-up available in Gray only. 5000 ft. put-up available in Purple only.
 The jacket and shield are bonded so both can be removed with automatic stripping equipment.

24 AWG Stranded (42x40) HC BC Conductors • Conductors Cabled with Fillers • TC "French Braid" Shield (95% Coverage) • BC Drain Wire
Datalene Insulation • Matte PVC Jacket (Available in Red, Yellow, Green, Blue, Gray or Black)

Digital Mic Cable High-Flex 60°C	1800F	NEC: CL2R	1	Black, Red	500*	152.4	12.0	5.5	23.7Ω/M'	5.0Ω/M'	.211	5.36	110	76%	12	39	26	85
					U-1000	U-304.8	26.0	11.8	77.7Ω/km	16.4Ω/km								
					1000*	304.8	24.0	10.9										



French Braid

*500 ft. and 1000 ft. put-ups available in Black only.

24 AWG Stranded (7x32) TC Conductors • Twisted Pairs • Overall Beldfoil Shield (100% Coverage) • 24 AWG TC Drain Wire
Plenum • Foam FEP Teflon® Insulation • Flamarrest® Jacket (Available in Natural White or Purple)

75°C, Non-conduit	1801B	NEC: CMP CEC: CMP FT6	1	Black, Red	500	152.4	6.0	2.7	23.7Ω/M'	18.9Ω/M'	.165	4.19	110	78%	12	39	26	85
					U-1000	U-304.8	14.0	6.4	77.7Ω/km	62.0Ω/km								
					1000	304.8	12.0	5.5										



24 AWG Stranded (7x32) TC Conductors • Dual Twisted Pairs • Overall Beldfoil Shield (100% Coverage) • 24 AWG TC Drain Wire
Datalene Insulation • Purple PVC Jacket in Zip-Cord Construction

60°C	1802B	NEC: CMR CEC: CMG FT4	2	Black, Red	500	152.4	16.5	7.5	23.7Ω/M'	18.9Ω/M'	.180	4.57	110	76%	12	39	26	85
					U-1000	U-304.8	35.0	15.9	77.7Ω/km	62.0Ω/km	x	x						
					1000	304.8	37.0	16.8			.360	9.14						



The jacket and shield are bonded so both can be removed with automatic stripping equipment.

22 AWG Stranded (7x30) TC Conductors • Twisted Pair with Fillers • Overall Beldfoil + TC Braid Shield (90% Coverage) • 24 AWG Drain Wire
Datalene Insulation • Black High-Flex Matte PVC Jacket

DMX512 Type High-Flex 60°C	1696A	—	1	Blue, White	250	76.2	8.0	3.6	17.8Ω/M'	4.6Ω/M'	.234	5.94	110	76%	13	43	26	85
					500	152.4	14.5	6.6	48.5Ω/km	15.2Ω/km								
					U-1000	U-304.8	30.0	13.6										
					1000	304.8	32.0	14.5										



Z-Fold®

BC = Bare Copper • DCR = DC Resistance • FEP = Fluorinated Ethylene Propylene • HC = High-conductivity • TC = Tinned Copper

*Capacitance between conductors.

**Capacitance between one conductor and other conductors connected to shield.

Teflon is a DuPont trademark.



For more information, contact Belden Technical Support: 1-800-BELDEN-1 • www.belden.com

AES/EBU Digital Audio Cable

Multi-Pair Snake Cables

Individually Shielded and Jacketed Pairs



Individually Shielded and Jacketed Pairs

NEC: CMG (CEC: CMG FT4)

Product Description

26 AWG or 24 AWG stranded tinned copper conductor. Datalene® insulation. Pairs individually shielded with bonded Beldfoil® with a drain wire and have numbered and color-coded PVC jackets (see Chart 7 in Technical Information Section for colors). Pair jackets and shields are bonded so both strip simultaneously with automatic stripping equipment. Overall Beldfoil shield/drain wire plus overall Purple PVC jacket and nylon rip cord.

Datalene insulation features include low dielectric constant and a dissipation factor for high-speed, low-distortion data handling. Physical properties include good crush resistance and light weight.

Color Code: Black, Red.

Specifications

Nominal OD — Conductor

26 AWG	.019" (.48mm)
24 AWG	.024" (.60mm)

Nominal OD — Insulation

26 AWG	.054" (1.37mm)
24 AWG	.070" (1.78mm)

Inner Pair Jacket OD

26 AWG	.136" (3.45mm)
24 AWG	.167" (4.24mm)

Approvals

NEC	CMG
CEC	CMG FT4

Nominal DCR (26 AWG)

Conductor	37.3Ω/M' (122.3Ω/km)
Shield	25.5Ω/M' (83.6Ω/km)

Nominal DCR (24 AWG)

Conductor	23.7Ω/M' (77.7Ω/km)
Shield	18.9Ω/M' (62.0Ω/km)

Nominal Impedance

110Ω ±10Ω

Nominal Velocity of Propagation

76%

Nominal Capacitance (26 AWG)

Between Conductors	12.5 pF/Ft. (41 pF/m)
Between Conductor/Shield*	25 pF/Ft. (82 pF/m)

Nominal Capacitance (24 AWG)

Between Conductors	12 pF/Ft. (39 pF/m)
Between Conductor/Shield*	26 pF/Ft. (86 pF/m)

DCR = DC Resistance

*Capacitance between one conductor and other conductors connected to shield.

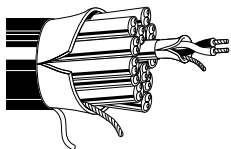

Part No.	No. of Pairs	Standard Lengths		Standard Unit Weight		Nominal OD	
		Ft.	m	Lbs.	kg	Inch	mm

Individually Shielded & Jacketed NEC: CMG (CEC: CMG FT4)

26 AWG (7x34)

7891A	2	500	152.4	28.0	12.7	.343	8.71
		1000	304.8	56.0	25.5		
7890A	4	100	30.5	8.2	3.7	.399	10.13
		250	76.2	18.0	8.2		
		500	152.4	31.0	14.1		
		1000	304.8	61.0	27.7		
7880A[†]	8	250	76.2	28.0	12.7	.541	13.74
		500	152.4	57.0	25.9		
		1000	304.8	142.0	64.4		

Fits metal shell 25-pin D-sub connectors.

7892A	12	500	152.4	85.5	37.9	.679	17.25
		1000	304.8	174.0	79.1		
7893A	16	500	152.4	109.5	49.8	.770	19.56
		1000	304.8	240.0	109.1		

Individually Shielded & Jacketed NEC: CMG (CEC: CMG FT4)

24 AWG (7x32) • Flexible

1803F	4	500	152.4	57.5	26.1	.488	12.39
		1000	304.8	107.0	48.6		
1805F	8	500	152.4	106.5	48.3	.661	16.79
		1000	304.8	211.0	95.7		
1806F	12	500	152.4	160.0	72.6	.829	21.06
		1000	304.8	330.0	149.7		
1850F	16	500	152.4	208.0	94.4	.944	23.98
		1000	304.8	407.0	184.6		
1852F	24	500	152.4	321.0	145.6	1.205	30.61
		1000	304.8	644.0	292.1		
1854F	32	1000	304.8	841.0	381.5	1.346	34.19

[†]7880A is designed to fit in 25-pin D-sub connectors used in digital console board equipment.

AES/EBU Digital Audio CableMulti-Pair Snake Cables
Individually Shielded Pairs**Individually Shielded Pairs**

NEC: CM (CEC: CM)

Product Description

24 AWG stranded (7x32) tinned copper conductors. Datalene® insulation. Twisted pairs individually Beldfoil® shielded (100% Coverage). Overall Chrome PVC jacket and 24 AWG stranded tinned copper drain wire.

Datalene insulation features include low dielectric constant and a dissipation factor for high-speed, low-distortion data handling. Physical properties include good crush resistance and light weight.

Color Code: See Chart 3 (in Technical Information Section)

Specifications

Nominal OD — Conductor	.024" (.60mm)
Nominal OD — Insulation	.061" (1.55mm)
Approvals	
NEC	CM
CEC	CM
UL Ratings	UL AWM Style 2493
Voltage Rating	300V
Temperature Rating	60°C
Non UL Temperature Rating	80°C
Nominal DCR	
Conductor	24.0Ω/M' (78.7Ω/km)
Shield	15.0Ω/M' (49.2Ω/km)
Nominal Impedance	100Ω
Nominal Velocity of Propagation	76%
Nominal Capacitance	
Between Conductors	12.5 pF/Ft. (41.0 pF/m)
Between Conductor/Shield*	23.2 pF/Ft. (76.1 pF/m)

DCR = DC Resistance

*Capacitance between one conductor and other conductors connected to shield.

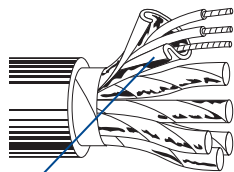

Z-Fold®

Part No.	No. of Pairs	Standard Lengths		Standard Unit Weight		Nominal OD	
		Ft.	m	Lbs.	kg	Inch	mm

Individually Shielded Pairs NEC: CM (CEC: CM)

24 AWG							
9729	2	100	30.5	4.3	2.0	.266	6.76
		500	152.4	20.5	9.3		
		1000	304.8	39.0	17.7		
		10000 [†]	3048.0	390.0	176.9		

For Plenum version of 9729, see 89729 or 82729.

9730	3	100	30.5	5.1	2.3	.334	8.48
		500	152.4	24.5	11.1		
		1000	304.8	46.0	20.9		
		10000 ^{††}	3048.0	520.0	236.4		

For Plenum version of 9730, see 89730.

9728	4	100	30.5	6.0	2.7	.363	9.22
		500	152.4	29.0	13.2		
		1000	304.8	51.0	23.1		

For Plenum version of 9728, see 89728.

9731	6	100	30.5	7.4	3.4	.421	10.69
		500	152.4	42.0	19.1		
		1000	304.8	83.0	37.7		

For Plenum version of 9731, see 89731.

9732	9	100	30.5	9.9	4.5	.488	12.40
		500	152.4	57.0	25.8		
		1000	304.8	106.0	48.1		

For Plenum version of 9732, see 89732.

9733	11	500	152.4	75.0	34.1	.575	14.61
-------------	----	-----	-------	------	------	------	-------

9734	12	500	152.4	79.5	36.1	.575	14.61
		1000	304.8	154.0	70.0		

For Plenum version of 9734, see 89734.

9735	15	500	152.4	95.0	43.2	.639	16.23
		1000	304.8	185.0	84.1		

9736	17	500	152.4	103.5	47.0	.671	17.04
		1000	304.8	210.0	95.5		

9737	19	1000	304.8	231.0	105.0	.671	17.04
-------------	----	------	-------	-------	-------	------	-------

9738	27	1000	304.8	334.0	151.8	.797	20.24
-------------	----	------	-------	-------	-------	------	-------

[†] Total length may vary -10 to +5% from length shown and may contain 2 pieces. Minimum length of any one piece will be 1500 ft.

^{††} Total length may vary -10 to +20% from length shown and may contain 2 pieces. Minimum length of any one piece will be 1500 ft.

AES/EBU Digital Audio CablePlenum-Rated, Multi-Pair Snake Cables
Individually Shielded Pairs**Individually Shielded Pairs**

NEC: CMP (CEC: CMP FT6)

Product Description

24 AWG stranded (7x32) tinned copper conductors. Foam FEP insulation. Twisted pairs individually Beldfoil® shielded (100% Coverage). Overall Gray fluorocopolymer jacket (except 82729 which has Natural Flamarrest® jacket). 24 AWG stranded tinned copper drain wire.

Color Code: See Chart 5 (in Technical Information Section)

Specifications**Nominal OD — Conductor** .024" (.60mm)**Nominal OD — Insulation** .062" (1.57mm)**Approvals**

NEC	CMP
CEC	CMP FT6

UL Ratings Non-conduit**Voltage Rating** 300V RMS**Nominal DCR**

Conductor	23.3Ω/M' (76.4Ω/km)
Shield	14.4Ω/M' (47.2Ω/km)

Nominal Impedance 100Ω**Nominal Velocity of Propagation** 76%**Nominal Capacitance**

Between Conductors	13.5 pF/Ft. (44 pF/m)
Between Conductor/Shield*	22.5 pF/Ft. (73.8 pF/m)

DCR = DC Resistance • FEP = Fluorinated Ethylene Propylene

*Capacitance between one conductor and other conductors connected to shield.

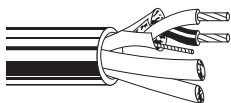

Part No.	No. of Pairs	Standard Lengths		Standard Unit Weight		Nominal OD	
		Ft.	m	Lbs.	kg	Inch	mm

Plenum Individually Shielded NEC: CMP (CEC: CMP FT6)

24 AWG							
82729	2	U-1000 1000	U-304.8 304.8	26.0 28.0	11.8 12.7	.255	6.48
89729	2	500 1000	152.4 304.8	17.0 31.0	7.7 14.1	.261	6.63
89730	3	500 1000	152.4 304.8	21.5 40.0	9.8 18.2	.278	7.06
89728	4	500 1000	152.4 304.8	26.5 50.0	12.0 22.7	.307	7.80
89705	5	500 1000	152.4 304.8	30.5 62.0	13.9 28.2	.333	8.46
89731	6	500 1000	152.4 304.8	35.0 71.0	15.9 32.3	.361	9.17
89757	7	500 1000	152.4 304.8	39.5 80.0	18.0 36.4	.361	9.17
89732	9	1000	304.8	108.0	49.0	.433	10.99
89734	12	500 1000	152.4 304.8	71.0 140.0	32.3 63.6	.498	12.65
89758	18	500 1000	152.4 304.8	100.5 204.0	45.7 92.7	.616	15.65

Spools are one piece, but length may vary ±10% from length shown.
Unreel® carton may vary -5% to +10% from length shown.

Speaker Wire and Cable

Overview



Electrolytic Tough Pitch (ETP) High-conductivity Copper Speaker Cables

Speaker cables are used to connect receivers or power amplifiers to speakers and are also used for the internal wiring of the speakers themselves.

High-conductivity Copper

All Belden® speaker cables utilize only high-conductivity copper produced by a process called Electrolytic Tough Pitch. This refining process produces a conductor that is 99.95% pure copper resulting in high-conductivity per ASTM B115. The high purity obtained from ETP copper results in audio cable performance that is comparable to that of oxygen-free copper cables.

Gage Selection

Because the impedance of the loud-speaker is quite low (typically 3 to 10 ohms) much of the power conducted through the cable is carried in the current domain which is affected by conductor resistance. The resistance of the cable between the speaker and the amplifier turns some of the amplifier's power into heat and does not get to the speaker.

The feedback from the speaker is altered by the cable. This feedback is used by the amplifier to correct the speaker's non-linearity. It is measured as the Damping factor by amplifier designers and is called "Servoing" by the Hi-Fi community.

In general, the higher the cable resistance, the lower the power level getting to the speaker, resulting in "sloppier" speaker performance due to damping.

Ultimately, the system designer must decide how to compromise system performance against system cost. In general, one of the least expensive ways to squeeze more and better performance out of the system hardware is to use larger speaker cables and cut your losses where they occur rather than try to "Band-Aid" the system later with equalization or more power.

The Cable Selection Guide can aid in determining the proper gage selection depending on the speaker impedance, acceptable power loss and cable run length.

Speaker Cable Selection Guide

AWG	4Ω Speaker			8Ω Speaker			70V Speaker*		
	Power (%) / Loss (dB/Ft.)								
	11% .5	21% 1.0	50% 3.0	11% .5	21% 1.0	50% 3.0	11% .5	21% 1.0	50% 3.0
12	140	305	1150	285	610	2285	6920	14890	56000
14	90	195	740	185	395	1480	4490	9650	36300
16	60	125	470	115	250	935	2840	6100	22950
18	40	90	340	85	190	685	2070	4450	16720
20	25	50	195	50	105	390	1170	2520	9500
22	15	35	135	35	70	275	820	1770	6650
24	10	25	85	20	45	170	520	1120	4210

The number of feet of cable you can run for a given loss and performance budget.

How to Use the Guide

- Step One** Select the appropriate speaker impedance column.
- Step Two** Select the appropriate power loss column deemed to be acceptable.
- Step Three** Select the applicable wire gage size and follow the row over to the columns determined in steps one and two. The number listed is the maximum cable run length.
- Example** The maximum run for 12 AWG in a 4 Ohm speaker system with 11% or .5 dB loss is 140 ft.

*70 volt line drive systems, while considered a potential for Hi-Fi performance, follow the same cable loss physics as the higher current (lower impedance) system. For the sake of this calculation a 25 watt 70 volts system (196Ω) was used.

Speaker Wire and Cable

Electrolytic Tough Pitch (ETP) High-Conductivity Copper Speaker Cables
Parallel Zip Constructions



Description	Part No.	UL NEC/ C(UL) CEC Type	No. of Cond.	Standard Lengths		Standard Unit Weight		Insulation Thickness		Nominal OD	
				Ft.	m	Lbs.	kg	Inch	mm	Inch	mm

24 AWG Stranded (7x32) ETP High-conductivity Copper Conductors • Parallel: (1) Tinned, (1) Bare

PVC Insulation (Available in Clear, White, Brown or Chrome)

300V 60°C (Clear)	8782	—	2	U-1000 ▲	U-304.8	7.0	3.2	.017	.43	.058	1.47
300V 75°C (Chrome, Brown, White)				1000 ♦	304.8	6.0	2.7			x	x
										.116	2.95

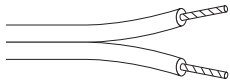

▲U-1000 ft. put-up available in Brown or Chrome only.
♦1000 ft. put-up available in White or Clear only.

22 AWG Stranded (7x30) ETP High-conductivity Copper Conductors • Parallel: (1) Tinned, (1) Bare

Clear PVC Insulation

300V 60°C	9712	—	2	1000	304.8	9.0	4.1	.017	.43	.065	1.65
										x	x
										.130	3.30

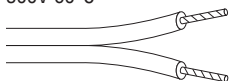

20 AWG Stranded (7x28) ETP High-conductivity Copper Conductors • Parallel: (1) Tinned, (1) Bare

Clear or Chrome PVC Insulation

300V 60°C (Clear)	8649	—	2	1000	304.8	12.0	5.5	.018	.46	.073	1.85
300V 75°C (Chrome)										x	x
VW-1										.146	3.71

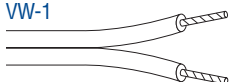

18 AWG Stranded (16x30) ETP High-conductivity Copper Conductors • Parallel: (1) Tinned, (1) Bare

Clear PVC Insulation

300V 60°C	9708	—	2	U-500	U-152.4	11.0	5.0	.032	.81	.110	2.79
				500	152.4	10.5	4.8			x	x
				U-1000	U-304.8	21.0	9.5			.220	5.59
				1000	304.8	21.0	9.5				

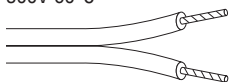

16 AWG Stranded (26x30) ETP High-conductivity Copper Conductors • Parallel: (1) Tinned, (1) Bare

Clear PVC Insulation

300V 60°C	9716	—	2	U-1000	U-304.8	27.0	12.2	.027	.69	.115	2.92
				1000	304.8	26.0	11.8			x	x
										.230	5.84

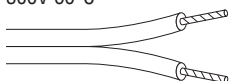

14 AWG Stranded (19x27) ETP High-conductivity Copper Conductors • Parallel: (1) Tinned, (1) Bare

Clear PVC Insulation

300V 60°C	9717	—	2	U-1000	U-304.8	42.0	19.1	.035	.89	.146	3.71
				1000	304.8	42.0	19.1			x	x
										.292	7.42

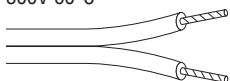

12 AWG Stranded (65x30) ETP High-conductivity Copper Conductors • Parallel: (1) Tinned, (1) Bare

Clear PVC Insulation

300V 60°C	9718	—	2	500	152.4	33.0	15.0	.045	1.14	.185	4.70
				1000	304.8	66.0	30.0			x	x
										.370	9.40

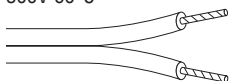

Speaker Wire and Cable

Electrolytic Tough Pitch (ETP) High-Conductivity Copper Speaker Cables
Open Twisted Construction



19 • Brilliance® Broadcast

Description	Part No.	UL NEC/ C(UL) CEC Type	No. of Cond.	Standard Lengths		Standard Unit Weight		Insulation Thickness		Nominal OD	
				Ft.	m	Lbs.	kg	Inch	mm	Inch	mm

22 AWG Stranded (7x30) ETP High-conductivity Copper Conductors • Cabled: (1) Tinned, (1) Bare

PVC Insulation • (Color Code: White)

UL Listed. Wires Misc. 90V 90°C VW-1	9151	—	2	U-1000	U-304.8	7.0	3.2	.012	.30	.108	2.74
--	-------------	---	---	--------	---------	-----	-----	------	-----	------	------



18 AWG Stranded (7x26) ETP High-conductivity Tinned Copper Conductors • Cabled

PVC Insulation • (Color Code: Black, Natural)

UL AWM Style 1007 (300V 80°C) VW-1	8460	—	2	U-1000 1000	U-304.8 304.8	18.0	8.2	.020	.51	.180	4.57
--	-------------	---	---	----------------	------------------	------	-----	------	-----	------	------



18 AWG Stranded (19x30) ETP High-conductivity Bare Copper Conductors • Cabled

Plenum • Flamarrest® Insulation • (Color Code: Black, Natural)

75°C	1863A	NEC: CL2P	2	1000	304.8	19.0	8.6	.022	.56	.178	4.52
------	--------------	--------------	---	------	-------	------	-----	------	-----	------	------



16 AWG Stranded (19x29) ETP High-conductivity Tinned Copper Conductors • Cabled

PVC Insulation • (Color Code: Black & Natural for 8470; Black & Orange for 9497)

UL AWM Style 1007 (300V 80°C) VW-1	8470	—	2	500	152.4	13.0	5.9	.023	.58	.210	5.33
				U-1000	U-304.8	26.0	11.8				
				1000	304.8	26.0	11.8				



	9497	—	2	1000	304.8	30.0	13.6	.023	.58	.210	5.33
--	-------------	---	---	------	-------	------	------	------	-----	------	------

16 AWG Stranded (19x29) ETP High-conductivity Bare Copper Conductors • Cabled

Plenum • Flamarrest Insulation • (Color Code: Black, Natural)

75°C	1862A	NEC: CL2P	2	1000	304.8	26.0	11.8	.022	.56	.202	5.13
------	--------------	--------------	---	------	-------	------	------	------	-----	------	------



Speaker Wire and Cable

Electrolytic Tough Pitch (ETP) High-Conductivity Copper Speaker Cables
Open Twisted Construction



Description	Part No.	UL NEC/ C(UL) CEC Type	No. of Cond.	Standard Lengths		Standard Unit Weight		Insulation Thickness		Nominal OD	
				Ft.	m	Lbs.	kg	Inch	mm	Inch	mm

14 AWG Stranded (19x27) ETP High-conductivity Bare Copper Conductors • Cabled

Plenum • Flamarrest® Insulation • (Color Code: Black, Natural)

150V RMS 75°C,	1861A	NEC: CL2P	2	1000	304.8	36.0	16.3	.022	.56	.236	5.99
----------------	--------------	--------------	---	------	-------	------	------	------	-----	------	------



12 AWG Stranded (19x25) ETP High-conductivity Bare Copper Conductors • Cabled

Plenum • Flamarrest Insulation • (Color Code: Black, Natural)

150V RMS 75°C,	1860A	NEC: CL2P	2	1000	304.8	58.0	26.4	.022	.56	.270	6.86
----------------	--------------	--------------	---	------	-------	------	------	------	-----	------	------



Speaker Wire and Cable

Electrolytic Tough Pitch (ETP) High-Conductivity Copper Speaker Cables
Twisted Jacketed Construction



19 • Brilliance® Broadcast

Description	Part No.	UL NEC/ C(UL) CEC Type	No. of Cond.	Color Code	Standard Lengths		Standard Unit Weight		Insulation Thickness		Jacket Thickness		Nominal OD	
					Ft.	m	Lbs.	kg	Inch	mm	Inch	mm	Inch	mm

22 AWG Stranded (7x30) Tinned Copper Conductors • Conductors Cabled

PVC Insulation • Chrome PVC Jacket															
	300V RMS 60°C	8442	NEC:	2	Black,	100	30.5	2.4	1.0	.015	.38	.025	.64	.170	4.32
			CMG:		Red	U-500	U-152.4	7.5	3.4						
			CEC:			500	152.4	7.5	3.4						
			CMG FT4			U-1000	U-304.8	15.0	6.8						
						1000	304.8	15.0	6.8						
						10000	3048.0	150.0	68.2						

For Plenum versions of 8442, see 88442 or 82442.

20 AWG Stranded (7x28) Tinned Copper Conductors • Twisted Pair

PVC Insulation • Chrome PVC Jacket															
	300V RMS 80°C	8205	NEC:	2	Black,	100	30.5	2.6	1.2	.013	.33	.025	.64	.180	4.57
			CMG:		Red	U-500	U-152.4	9.0	4.1						
			CEC:			500	152.4	9.0	4.1						
			CMG FT4			U-1000	U-304.8	17.0	7.7						
						1000	304.8	18.0	8.2						

18 AWG Stranded (7x26) Tinned Copper Conductors • Twisted Pair

PVC Insulation • Chrome PVC Jacket															
	300V RMS 80°C	8461	NEC:	2	Black,	100	30.5	3.2	1.4	.022	.56	.028	.71	.234	5.94
			CMG:		White	U-500	U-152.4	13.5	6.1						
			CEC:			500	152.4	13.5	6.1						
			CMG FT4			U-1000	U-304.8	26.0	11.8						
						1000	304.8	27.0	12.2						

16 AWG Stranded (19x29) Tinned Copper Conductors • Twisted Pair

PVC Insulation • Chrome PVC Jacket															
	UL AWM Style 2598 (300V 60°C) (80°C non-UL)	8471	NEC:	2	Black,	U-500	U-152.4	20.0	9.1	.023	.58	.032	.81	.274	6.96
			CMG:		White	500	152.4	20.0	9.1						
			CEC:			U-1000	U-304.8	38.0	17.2						
			CMG FT4			1000	304.8	40.0	18.2						

14 AWG Stranded (42x30) Tinned Copper Conductors • Twisted Pair

PVC Insulation • Chrome PVC Jacket															
	UL AWM Style 2587 (600V 90°C)	8473	NEC:	2	Black,	U-500	U-152.4	29.0	13.2	.031	.79	.032	.81	.340	8.64
			CL3		White	500	152.4	30.5	13.9						
			CEC:			1000	304.8	58.0	26.4						
			FAS 90 FT4												

See NEC Guidelines for applicable CL3 voltage ratings (300V RMS).

12 AWG Stranded (65x30) Tinned Copper Conductors • Twisted Pair

PVC Insulation • Chrome PVC Jacket															
	UL AWM Style 2587 (600V 90°C)	8477	NEC:	2	Black,	U-500	U-152.4	41.5	18.8	.032	.81	.035	.89	.386	9.80
			CL3R		White	500	152.4	43.5	19.7						
						1000	304.8	85.0	38.6						

See NEC Guidelines for applicable CL3 voltage ratings (300V RMS).



Speaker Wire and Cable

Low-Capacitance Oxygen-Free, High-Conductivity (OFHC) Speaker Cable
Twisted Jacketed Construction



Description	Part No.	UL NEC/ C(UL) CEC Type	No. of Cond.	Standard Lengths		Standard Unit Weight		Insulation Thickness		Jacket Thickness		Nominal OD		Nominal Capacitance*	
				Ft.	m	Lbs.	kg	Inch	mm	Inch	mm	Inch	mm	pF/Ft.	pF/m

Low Cap • 16 AWG Stranded (65x34) Oxygen-free High-Conductivity Bare Copper Conductors • Conductors Cabled • Unshielded

Polyolefin Insulation • PVC Jacket (Available in Black, White, Gray, Blue or Green)

	1307A <small>new</small>	NEC: CMR, CL3R CEC: CMG FT4	2	U-500	U-152.4	15.0	6.8	.013	.32	.022	.56	.210	5.33	19.9	65.3
				1000†	304.8	29.0	13.2								

Suitable for Direct Burial applications. White and Black jackets are Sunlight-resistant.

	1308A <small>new</small>	NEC: CMR, CL3R CEC: CMG FT4	4	U-500	U-152.4	26.5	12.0	.013	.32	.026	.66	.270	6.86	19.9	65.3
				1000†	304.8	54.0	24.5								

Suitable for Direct Burial applications. White and Black jackets are Sunlight-resistant.

Low Cap • 14 AWG Stranded (105x34) Oxygen-free High-Conductivity Bare Copper Conductors • Conductors Cabled • Unshielded

Polyolefin Insulation • PVC Jacket (Available in Black, White, Gray, Blue or Green)

	1309A <small>new</small>	NEC: CMR, CL3R CEC: CMG FT4	2	U-500	U-152.4	22.5	10.2	.016	.39	.027	.69	.264	6.71	20.5	67.3
				1000†	304.8	46.0	20.9								

Suitable for Direct Burial applications. White and Black jackets are Sunlight-resistant.

	1310A <small>new</small>	NEC: CMR, CL3R CEC: CMG FT4	4	U-500	U-152.4	41.5	18.8	.016	.39	.033	.94	.319	8.10	20.5	67.3
				1000†	304.8	84.0	38.1								

Suitable for Direct Burial applications. White and Black jackets are Sunlight-resistant.

Low Cap • 12 AWG Stranded (168x34) Oxygen-free High-Conductivity Bare Copper Conductors • Conductors Cabled • Unshielded

Polyolefin Insulation • PVC Jacket (Available in Black, White or Gray)

	1311A <small>new</small>	NEC: CMR, CL3R CEC: CMG FT4	2	U-500	U-152.4	36.5	16.6	.018	.46	.036	.91	.352	8.94	22.3	73.2
				500	152.4	36.5	16.6								
				1000†	304.8	74.0	33.6								

Suitable for Direct Burial applications. White and Black jackets are Sunlight-resistant.

	1312A <small>new</small>	NEC: CMR, CL3R CEC: CMG FT4	4	500	152.4	66.5	30.2	.018	.46	.043	1.09	.423	10.74	22.3	73.2
				1000†	304.8	132.0	59.9								

Suitable for Direct Burial applications. White and Black jackets are Sunlight-resistant.

Low Cap • 10 AWG Stranded (259x34) Oxygen-free High-Conductivity Bare Copper Conductors • Conductors Cabled

Polyolefin Insulation • PVC Jacket (Available in Black, White or Gray)

	1313A <small>new</small>	NEC: CMR, CL3R CEC: CMG FT4	2	500	152.4	55.0	25.0	.019	.48	.044	1.12	.428	10.87	23.2	76.1
				1000†	304.8	109.0	49.5								

Suitable for Direct Burial applications. White and Black jackets are Sunlight-resistant.

OFHC = Oxygen-Free High-Conductivity

*Capacitance between conductors.

†1000 ft. put-ups not available in Blue or Green.

Color Code Chart

Cond.	Color
1	Black
2	Red
3	White
4	Green



Speaker Wire and Cable

High-Flex Multi-Conductor Cables

Bi-amp and Tri-amp Speaker Connections



Description	Part No.	UL NEC/ C(UL) CEC Type	No. of Cond.	Color Code	Standard Lengths		Standard Unit Weight		Insulation Thickness		Jacket Thickness		Nominal OD	
					Ft.	m	Lbs.	kg	Inch	mm	Inch	mm	Inch	mm

14 AWG Stranded (104x34) Bare Copper Conductors • Conductors Cabled with Fillers • Paper Wrap

PVC Insulation • Overall Matte Black PVC Jacket

High-Flex 60°C 	1810A	—	4	Red, Green, White, Black	250	76.2	26.3	11.9	.025	.64	.040	1.02	.390	9.91	
					500	152.4	55.5	25.2							
					1000	304.8	114.0	51.7							

Compatible with Neutrik Speakon® Connectors.

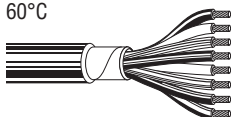
High-Flex 60°C 	1811A	—	8	Brown, Red, Orange, Yellow, Green, White, Blue, Black	1000	304.8	205.0	93.0	.025	.64	.040	1.02	.515	13.08	

Compatible with Neutrik Speakon® Connectors.

10 AWG Stranded (65x28) Bare High-conductivity ETP Copper Conductors • Highly Stranded for Ultra Flexibility • Rip Cord

High-grade PVC Insulation • PVC Jacket (Available in Gray)

High-Flex 75°C, UL 1581 	5T00UP	NEC: CL2 Audio Use Only	2	Black, White	500	152.4	49.5	22.5	.020	.38	.026	.66	.356	9.04
					1000	304.8	96.0	49.5						

For Plenum version of 5T00UP, see 6T00UP.

Jacket sequentially marked at 2 ft. intervals.

10 AWG Stranded (65x28) Bare Copper Conductors • Cabled • Rip Cord

Plenum • Flamarrest® Insulation • Natural Flamarrest Jacket

High-Flex 150V 75°C 	6T00UP	NEC: CL2P Audio Use Only	2	Black, White	1000	304.8	85.0	38.6	.011	.28	.015	.38	.308	7.82

Jacket sequentially marked at 2 ft. intervals.

Neutrik is a Liechtenstein Corporation trademark.

Special Application Audio, Communication and Instrumentation Cable

Audio Connecting Cables and Dual Channel Audio Cables



Description	Part No.	UL NEC/ C(UL) CEC Type	No. of Cond.	Color Code	Standard Lengths		Standard Unit Weight		Insulation Thickness		Jacket Thickness		Nominal OD		Nominal Capacitance	
					Ft.	m	Lbs.	kg	Inch	mm	Inch	mm	Inch	mm	pF/Ft.*	pF/m*

25 AWG Stranded (7x33) Conductor • (3) TC, (4) TCCS • Double Beldfoil® Shield (100% Coverage) • 26 AWG Stranded TC Drain Wire

FPE Insulation • Chrome PVC Jacket

Miniature 80°C	8417	—	1	—	250	76.2	3.3	1.5	.020	.51	.026	.66	.140	3.56	29	95
-------------------	------	---	---	---	-----	------	-----	-----	------	-----	------	-----	------	------	----	----



25 AWG Stranded (7x33) Conductor • (3) TC, (4) TCCS • Tinned Copper Spiral Wrapped Shield (86% Coverage)

FPE Insulation • Chrome PVC Jacket

Low-Capacitance 80°C	8421	—	1	—	250	76.2	4.5	2.0	.051	1.30	.023	.58	.180	4.57	16	53
-------------------------	------	---	---	---	-----	------	-----	-----	------	------	------	-----	------	------	----	----



24 AWG Uni-strand (7x32) Tinned Copper Conductor • Beldfoil Shield (100% Coverage)

Flame-retardant Polypropylene Insulation • Black PVC Jacket

UL AWM Style 1770 (300V 80°C) VV-1	9264	—	1	—	1000	304.8	14.0	6.4	.027	.69	.020	.51	.122	3.10	30	99
													.146	3.71		

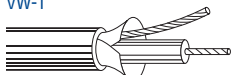

Nominal impedance: 50 ohms.
Tear-drop, machine strippable coaxial cable.

Dual Channel • 30 AWG Stranded (7x38) TCCS Conductors • Individual Tinned Copper Spiral Wrapped Shield (85% Coverage)

FPE Insulation • Black PVC Jacket • Polarity Ribbed

Low-Capacitance 70°C	9454	—	2	—	100	30.5	3.5	1.6	.049	1.24	.020	.51	.160	4.06	12	39
													.320	8.13	each channel	



Stereo connecting cable

Dual Channel • 25 AWG Stranded (7x38) Conductors • (3) TC, (4) TCCS • Individual TC Spiral Wrapped Shield (90% Coverage)

Polyethylene Insulation • Gray PVC Jacket • Polarity Rib on Red Conductor

80°C	8416	—	2	—	250	76.2	4.8	2.2	.018	.46	.020	.51	.106	2.69	36	118
													.213	5.41	each channel	

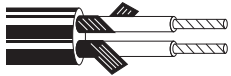

For use with head sets, stereo and language labs.

FPE = Foam Polyethylene • TC = Tinned Copper • TCCS = Tinned Copper-covered Steel

*Capacitance between conductors.

Special Application Audio, Communication and Instrumentation Cable

Multimedia Control Cables

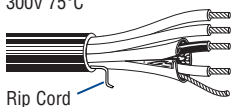

19 • Brilliance® Broadcast

Description	Part No.	UL NEC/ C(UL) CEC Type	No. of Cond.	Color Code	Standard Lengths		Standard Unit Weight		Insulation Thickness		Jacket Thickness		Nominal OD		Nominal Capacitance			
					Ft.	m	Lbs.	kg	Inch	mm	Inch	mm	Inch	mm	* pF/ Ft.	* pF/ m	** pF/ Ft.	** pF/ m
22 AWG Stranded (7x30) TC Conductors (Data), STP w/Beldfoil®, TC Drain Wire • 18 AWG (16x30) TC Conductors (Power), Unshielded Pair																		
FPE Insulation (Data) • F-R PVC Insulation (Power) • F-R PVC Jacket (Available in Black, White or Aqua)																		
300V 75°C  Rip Cord	1502R	NEC:	1 STP	Pair:	500	152.4	20.0	9.1	Data:	.039	.99	.250	6.35	14	46	38	125	
		CMR CEC: CMG FT4	+2/C	Blue, White Cond.: Red, Black	1000	304.8	44.0	20.0	.025 Power: .013	.64 .33	22 AWG Data Pair Impedance: 100Ω							

Sequential footing marking every two feet.

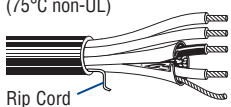
22 AWG (7x30) TC Conductors, STP w/Beldfoil, TC Drain Wire • 18 AWG (16x30) TC Conductors Unshielded • Polypropylene Binder Tape																	
Plenum • Foam FEP Insulation (Data) • Flamarrest® Insulation (Power) • Natural Flamarrest Jacket																	
300V 60°C (75°C non-UL)  Rip Cord	1502P	NEC:	1 STP	Pair:	1000	304.8	31.0	14.1	Data:	.015	.381	.205	5.21	14	46	38	125
		CMP CEC: CMP FT6	+2/C	Blue, White Cond.: Red, Black					.025 Power: .011	.64 .28	22 AWG Data Pair Impedance: 100Ω						

BC = Bare Copper • DCR = DC Resistance • EPDM = Ethylene Propylene Diene Monomer • FEP = Fluorinated Ethylene Propylene • FPE = Foam Polyethylene • F-R = Flame-retardant • STP = Shielded Twisted Pair • TC = Tinned Copper

*Capacitance between conductors.

**Capacitance between one conductor and other conductors connected to shield.

Special Application Audio, Communication and Instrumentation Cable

Microphone/Musical Instrument Cables



Description	Part No.	UL NEC/ C(UL) CEC Type	No. of Cond.	Color Code	Standard Lengths		Standard Unit Weight		Insulation Thickness		Jacket Thickness		Nominal OD		Nominal Capacitance			
					Ft.	m	Lbs.	kg	Inch	mm	Inch	mm	Inch	mm	* pF/ Ft.	* pF/ m	** pF/ Ft.	** pF/ m

Mic • 20 AWG Stranded (19x32) High-conductivity TC Conductors, Cabled • Rayon Braid • TC Braid Shield (84% Coverage)

Polyethylene Insulation • Chrome PVC Jacket

Low-Impedance	8405	—	5	Black,	250	46.2	14.8	6.7	.016	.41	.035	.89	.281	7.14	23	76	40	131		
UL AWM Style 2094				Clear,	500	152.4	29.5	13.4												
(300V 60°C)				Green,	1000	304.8	63.0	28.6												
VW-1				Red, Blue																



Mic • 20 AWG Stranded (26x34) High-conductivity TC Conductors, Cabled • Cotton Wrap • Rayon Braid • TC Braid Shield (85% Coverage)

Rubber Insulation • Black EPDM Rubber Jacket

Low-Impedance	8425	—	5	Blue,	100	30.5	7.8	3.5	.023	.58	.031	.79	.318	8.08	30	98	55	180
600V RMS 90°C (60°C non-UL)				Orange, Black, White, Brown	250	46.2	17.3	7.8										
	8426	—	6	(Same as 8425)	100	30.5	9.0	4.1	.023	.58	.037	.94	.342	8.69	30	98	55	180
				+ Green	250	46.2	21.0	9.5										
	8427	—	7	(Same as 8426)	100	30.5	9.8	4.5	.023	.58	.041	1.04	.355	9.02	30	98	55	180
				+ Red	250	46.2	22.3	10.1										
	8418	—	8	(Same as 8427)	100	30.5	11.0	5.0	.023	.58	.037	.94	.381	9.68	30	98	55	180
				+ Yellow	250	46.2	25.0	11.3										



EPDM = Ethylene Propylene Diene Monomer • TC = Tinned Copper

*Capacitance between conductors.

**Capacitance between one conductor and other conductors connected to shield.

Standard Analog Video Cable

75 Ohm Miniature Coax



Belden standard video cables are typically used in non-critical video applications such as video equipment rack wiring, closed circuit TV (CCTV), master antenna TV(MATV) and color or monochrome video monitor hook-ups. Applications such as these do not require Precision Video coaxes which have extremely tight electrical tolerances. (See Precision Video cables, pages 19.49 through 19.58.)

Standard video coaxes are available in both solid and stranded designs. Stranded designs are recommended for flexing applications such as interconnection of CCTV cameras with pan and tilt capabilities, or remote camera hook-ups where the cable is constantly being spooled and despoiled from a reel. Belden's Brilliance high-flex part no. 8241F is ideal for these types of applications.

Video coax cables have a characteristic impedance of 75 ohms. This value was not chosen arbitrarily. Physics shows that optimum attenuation characteristics occur at 77 ohms. Materials and design lead to the selection of 75 ohms as the optimum compromise for low power applications.

Description	Part No.	UL NEC/ C(UL) CEC Type	Standard Lengths		Standard Unit Weight		Conductor (stranding) Diameter Nom. DCR	Insulation Diameter		Shielding Materials Nom. DCR	Nominal OD		Nom. Imp. (Ω)	Nom. Vel. of Prop.	Nominal Capacitance		Nominal Attenuation		
			Ft.	m	Lbs.	kg		Inch	mm		Inch	mm			pF/Ft.	pF/m	MHz	dB/100 Ft.	dB/100m
30 AWG Stranded (7x38) .012" Tinned Copper Conductor • Tinned Copper Braid Shield (89% Coverage)																			
Foam HDPE Insulation • Black PVC Jacket																			
UL AWM Style 1375 (30V 60°C)	9221	—	100	30.5	1.5	1.0	30 AWG (7x38) .012"	.058	1.47	TC Braid 89% Shield Coverage	.097	2.46	75	78%	17.3	56.8	1	.7	2.3
			U-500	U-152.4	4.0	1.8	TC			11.7Ω/M'							4	1.3	4.3
			500	152.4	4.0	1.8	100.0Ω/M'			38.4Ω/km							5	1.6	5.2
							328.0Ω/km										10	2.2	7.2
																	50	5.1	16.7
																	100	7.3	23.9
																	200	10.5	34.4
																	400	15.5	50.9
																	1000	26.6	87.3

27 AWG Stranded (7x35) .017" Bare Copper-covered Steel Conductor • Tinned Copper Braid Shield (93% Coverage)																			
Polyethylene Insulation • Black PVC Jacket																			
UL AWM Style 1354 (30V 60°C) (1700V non-UL)	8218	—	U-500	U-152.4	8.5	3.9	27 AWG (7x35) .017"	.100	2.54	TC Braid 93% Shield Coverage	.150	3.81	75	66%	20.5	67.3	1	1.2	3.9
			500	152.4	8.0	3.6	BCCS			5.7Ω/M'							10	2.4	7.9
			U-1000	U-304.8	16.0	7.3	120.0Ω/M'			18.7Ω/km							50	4.2	13.8
			1000	304.8	14.0	6.4	393.7Ω/km										100	5.7	18.7
																	200	8.3	27.2
																	400	12.1	39.7
																	700	16.5	54.1
																	900	19.0	62.3
																	1000	20.0	65.6

Miniature • 25 AWG Solid .018" Tinned Copper Conductors • Duobond® (100% Coverage) + TC Braid Shield (95% Coverage)																			
Gas-injected Foam HDPE Insulation • Black PVC Jacket																			
1281R <small>new</small>	NEC: CMR	1	1000	304.8	8.0	3.6	25 AWG (solid) .018" TC	.074	1.88	Duobond (100%) + TC Braid	.114	2.90	75	80%	17.0	55.8	1	.5	1.7
	CEC: CMG						34.0Ω/M'			5.4Ω/M'							5	1.2	3.8
							111.6Ω/km			17.7Ω/km							50	3.7	12.1
																	100	4.9	16.1
																	200	6.7	22.0
																	400	9.5	31.2
																	700	13.4	44.0
																	900	15.0	49.2
																	1000	15.8	51.8
																	3000	31.2	102.4

Plenum • FPFA Insulation • Black Flamarrest® Jacket																			
1282P <small>new</small>	NEC: CMP	1	1000	304.8	10.0	4.5	25 AWG (solid) .018" TC	.074	1.88	Duobond (100%) + TC Braid	.114	2.90	75	81%	17.0	55.8	1	.4	1.3
	CEC: CMP FT6						31.8Ω/M'			5.8Ω/M'							5	.9	3.0
							104.3Ω/km			19.0Ω/km							50	3.7	12.1
																	100	5.0	16.4
																	200	7.0	23.0
																	400	10.0	32.8
																	700	14.5	47.6
																	900	17.0	55.8
																	1000	17.5	57.4
																	3000	37.0	121.4

BCCS = Bare Copper-covered Steel • DCR = DC Resistance • FPFA = Foam Perfluoroalkoxy • HDPE = High-density Polyethylene • TC = Tinned Copper

Standard Analog Video Cable

75 Ohm High-Frequency Cables

Conformable® Coax Cable



Description	Part No.	UL NEC/ C(UL) CEC Type	Standard Lengths		Standard Unit Weight		Conductor (stranding) Diameter Nom. DCR	Insulation Diameter		Shielding Materials Nom. DCR	Nominal OD		Nom. Imp. (Ω)	Nom. Vel. of Prop.	Nominal Capacitance		Nominal Attenuation		
			Ft.	m	Lbs.	kg		Inch	mm		Inch	mm			pF/Ft.	pF/m	MHz	dB/100 Ft.	dB/100m

29 AWG Solid .011" Silver-coated Copper-covered Steel Conductor • Copper-Tin Composite Shield (100% Coverage)

TFE Teflon® Insulation • Unjacketed

UL AWM	1672A*	—	500 ^{††}	152.4	7.5	3.4	29 AWG	.062	1.57	CT	.087	2.21	75	69.5%	19.5	64.0	1	1.6	5.3
Style 10245			1000 ^{††}	304.8	14.0	6.4	(solid)			Composite							10	1.8	5.9
(30V 105°C)							.011"			100% Shield							50	4.1	13.5
(1500V RMS 200°C non-UL)							SCCCS			Coverage							100	6.5	21.3
							205.0Ω/M'			10.0Ω/M'							200	9.0	29.5
							672.4Ω/km			33.5Ω/km							400	12.8	42.0
																	700	18.0	59.1
																	1000	22.1	72.5



TFE Teflon Insulation • PVC Jacket (Black or Clear)

UL AWM	1672J*	—	100 ^{†*}	30.5	3.1	1.4	29 AWG	.062	1.57	CT	.127	3.23	75	69.5%	19.5	64.0	1	1.6	5.3
Style 10245			500 [†]	152.4	9.5	4.3	(solid)			Composite							10	1.8	5.9
(30V 105°C)			1000 ^{††}	304.8	17.0	7.7	.011"			100% Shield							50	4.1	13.5
(1500V RMS 200°C non-UL)							SCCCS			Coverage							100	6.5	21.3
							205.0Ω/M'			10.0Ω/M'							200	9.0	29.5
							672.4Ω/km			33.5Ω/km							400	12.8	42.0
																	700	18.0	59.1
																	1000	22.1	72.5



*100 ft. put-up available in Clear only.

29 AWG Solid .011" Silver-plated Copper Conductor • Copper-Tin Composite Shield (100% Coverage)

TFE Teflon Insulation • Unjacketed

UL AWM	1672B*	—	100 [†]	30.5	2.5	1.1	29 AWG	.062	1.57	CT	.087	2.21	75	69.5%	19.5	64.0	1	1.2	3.9
Style 10245			500 [†]	152.4	7.5	3.4	(solid)			Composite							10	1.8	5.9
(30V 105°C)			1000 [†]	304.8	14.0	6.4	.011"			100% Shield							50	4.1	13.5
(1500V RMS 200°C non-UL)							SPC			Coverage							100	6.5	21.3
							11.0Ω/M'			10.0Ω/M'							200	9.0	29.5
							36.9Ω/km			33.5Ω/km							400	12.8	42.0
																	700	18.0	59.1
																	1000	22.1	72.5



Non-ferrous design

CT = Copper Tin • DCR = DC Resistance • SCCC = Silver-coated Copper-covered Steel • SPC = Silver-plated Copper

Contact the Belden Customer Service Department for a Comprehensive Connector Cross Reference. **1-800-BELDEN-1**.

*Protected by one or more of U.S. Patent Nos. 4,694,122 and 5,292,001. Patent held in the U.S., Singapore, Australia, Germany, France and England. Patent pending in Japan.

†May contain more than one piece. Minimum length of any one piece is 25 ft.

††500 ft. put-up: Exact 5 pieces (maximum), 50 feet minimum length
1000 ft. put-up: Exact 8 pieces (maximum), 50 feet minimum length

Teflon is a DuPont trademark.



Standard Analog Video Cable

75 Ohm Coax
RG-59/U Type



Description	Part No.	UL NEC/ C(UL) CEC Type	Standard Lengths		Standard Unit Weight		Conductor (stranding) Diameter Nom. DCR	Insulation Diameter		Shielding Materials Nom. DCR	Nominal OD		Nom. Imp. (Ω)	Nom. Vel. of Prop.	Nominal Capacitance		Nominal Attenuation		
			Ft.	m	Lbs.	kg		Inch	mm		Inch	mm			pF/Ft.	pF/m	MHz	dB/100 Ft.	dB/100m

23 AWG Solid .023" Bare Copper or Bare Copper-covered Steel Conductor • Bare Copper Braid Shield (95% Coverage)

Polyethylene Insulation • Black or Colored PVC Jacket *																			
UL AWM Style 1354 (30V 75°C)	8241	NEC: CM	100	30.5	4.4	2.0	23 AWG	.146	3.71	BC Braid	.240	6.09	75	66%	20.5	67.3	1	.6	2.0
			500	152.4	18.5	8.4	.023"			95% Shield							10	1.1	3.6
			1000	304.8	36.9	16.8	BCCS			Coverage							50	2.4	7.9
300V RMS (UL)			U-1000	U-304.8	38.0	17.2	49.0Ω/M'			2.6Ω/M'							100	3.4	11.2
1700V RMS (non-UL)			2000	609.6	80.0	36.3	160.7Ω/km			8.5Ω/km							200	4.9	16.1
			5000	1524.0	200.0	90.7											400	7.0	23.0
																	700	9.7	31.8
																	900	11.1	36.4
																	1000	12.0	39.4

*U-1000 ft. put-up also available in Red, Orange, Yellow, Green, Blue or White.

Flame-retardant Semi-foam Polyethylene Insulation • Black PVC Jacket																			
UL AWM Style 1354 (30V 75°C)	8241A	NEC: CMG CEC: CMG FT4	U-1000	U-304.8	40.0	18.1	23 AWG (solid)	.146	3.71	BC Braid	.242	6.15	75	66%	20.5	67.3	1	.6	2.0
			1000	304.8	42.0	19.0	.023"			95% Shield							5	.9	3.0
							BCCS			Coverage							10	1.1	3.6
300V RMS (UL)							49.0Ω/M'			2.6Ω/M'							50	2.4	7.9
							160.7Ω/km			8.5Ω/km							100	3.4	11.2
																	200	4.9	16.1
																	400	7.0	23.0
																	700	10.1	33.1
																	900	11.7	38.2
																	1000	13.2	43.3

Suitable for Indoor and Outdoor applications.

Polyethylene Insulation • Black PVC Jacket																			
UL AWM Style 1354 (30V 80°C)	8241B	NEC: CM CEC: CM	U-1000	U-304.8	36.0	16.3	23 AWG (solid)	.146	3.71	BC Braid	.242	6.15	75	66%	20.5	67.3	1	.4	1.3
			1000	304.8	37.0	16.8	.023"			95% Shield							10	1.1	3.6
							BC			Coverage							50	2.4	7.9
300V RMS (UL)							20.4Ω/M'			2.9Ω/M'							100	3.4	11.2
1700V RMS (non-UL)							66.9Ω/km			9.5Ω/km							200	4.9	16.1
																	400	7.0	23.0
																	700	9.7	31.8
																	900	11.1	36.4
																	1000	12.0	39.4

Suitable for Indoor and Outdoor applications.

22 AWG Stranded (7x30) .030" Bare Copper Conductor • Bare Copper Braid Shield (95% Coverage)

Foam Polyethylene Insulation • PVC Jacket (Available in Matte Black, Red, Blue, Green, Yellow, White or Gray)																			
High-Flex 60°C	8241F	—	1000	304.8	35.0	15.9	22 AWG (7x30)	.146	3.71	BC Braid	.242	6.15	75	78%	17.3	56.8	1	.3	1.0
							.030"			95% Shield							10	.9	3.0
							BC			Coverage							50	2.1	6.9
300V RMS (non-UL)							15.0Ω/M'			2.6Ω/M'							100	3.0	9.8
							49.2Ω/km			8.5Ω/km							200	4.5	14.8
																	400	6.6	21.7
																	700	8.9	29.2
																	900	10.1	33.1
																	1000	10.9	35.8

23 AWG Solid .023" Bare Copper-covered Steel Conductor • Bare Copper Braid Shield (97% Coverage)

Plenum • FEP Insulation • Black FEP Jacket																			
200°C	88241	NEC: CMP CEC: CMP FT6	500	152.4	18.0	8.2	23 AWG (solid)	.132	3.35	BC Braid	.190	4.83	75	69.5%	19.5	64.0	1	.5	1.6
			1000	304.8	36.0	16.3	.023"			97% Shield							10	1.0	3.3
							BCCS			Coverage							50	2.3	7.5
300V RMS (UL)							49.0Ω/M'			2.6Ω/M'							100	3.3	10.8
1700V RMS (non-UL)							160.7Ω/km			8.5Ω/km							200	5.2	17.1
																	400	8.4	27.6
																	700	11.6	38.0
																	900	13.8	45.3
																	1000	14.8	48.5

Suitable for Outdoor and Direct Burial applications.

Plenum • FEP Insulation • Natural Flamarrest® Jacket																			
60°C	82241	NEC: CMP CEC: CMP FT6	U-500	U-152.4	18.5	8.4	23 AWG (solid)	.134	3.40	BC Braid	.190	4.83	75	69.5%	19.5	64.0	1	.5	1.6
			U-1000	U-304.8	36.0	16.3	.023"			97% Shield							10	1.0	3.3
			1000	304.8	34.0	15.4	BCCS			Coverage							50	2.3	7.5
300V RMS (UL)							49.0Ω/M'			2.6Ω/M'							100	3.3	10.8
1700V RMS 75°C (non-UL)							160.7Ω/km			8.5Ω/km							200	5.2	17.1
																	400	8.4	27.6
																	700	11.6	38.0
																	900	13.8	45.3
																	1000	14.8	48.5

BC = Bare Copper • BCCS = Bare Copper-covered Steel • DCR = DC Resistance

Contact the Belden Customer Service Department for a Comprehensive Connector Cross Reference. 1-800-BELDEN-1. Request quotations of RG/U cables not listed.



Standard Analog Video Cable

75 Ohm Coax
RG-59/U Type



Description	Part No.	UL NEC/ C(UL) CEC Type	Standard Lengths		Standard Unit Weight		Conductor (stranding) Diameter Nom. DCR	Insulation Diameter		Shielding Materials Nom. DCR	Nominal OD		Nom. Imp. (Ω)	Nom. Vel. of Prop.	Nominal Capacitance		Nominal Attenuation		
			Ft.	m	Lbs.	kg		Inch	mm		Inch	mm			pF/Ft.	pF/m	MHz	dB/100 Ft.	dB/100m

23 AWG Solid Bare Copper-covered Steel Conductor • Bare Copper Braid Shield (95% Coverage)

Polyethylene Insulation • Black PVC Jacket																			
UL AWM	8263	NEC:	U-500	U-152.4	19.5	8.9	23 AWG	.146	3.71	BC Braid	.242	6.15	75	66%	20.5	67.3	1	.6	2.0
Style 1354		CMX:	U-1000	U-304.8	38.0	17.2	(solid)			95% Shield							10	1.1	3.6
(30V 60°C)		CEC:	1000	304.8	39.0	17.7	.023"			Coverage							50	2.4	7.9
VW-1		CMX:					BCCS			2.6Ω/M'							100	3.4	11.2
							49.0Ω/M'			8.5Ω/km							200	4.9	16.1
							160.7Ω/km										400	7.0	23.0
																	700	9.7	31.8
																	900	11.1	36.4
																	1000	12.0	39.4

150V RMS (UL), 1700V RMS (non-UL)
Non-contaminating Black PVC Jacket. Suitable for Indoor and Outdoor applications.

22 AWG Solid Bare Copper-covered Steel Conductor • Bare Copper Braid Shield (85% Coverage)

Polyethylene Insulation • Black PVC Jacket																			
UL AWM	9244	NEC:	U-500	U-152.4	18.0	8.2	22 AWG	.146	3.71	BC Braid	.242	6.15	75	66%	19.4	63.6	1	.6	2.0
Style 1354		CMX:	U-1000	U-304.8	35.0	15.9	(solid)			85% Shield							10	1.1	3.6
(30V 80°C)		CEC:	1000	304.8	36.0	16.4	.025"			Coverage							50	2.4	7.9
VW-1		CMX:	3280	1000.0	118.1	53.8	BCCS			4.5Ω/M'							100	3.4	11.2
							50.0Ω/M'			14.8Ω/km							200	4.9	16.1
							164.0Ω/km										400	7.0	23.0
																	700	9.7	31.8
																	900	11.1	36.4
																	1000	12.0	39.4

150V RMS (UL), 1700V RMS (non-UL)
Suitable for Indoor and Outdoor applications.

Foam Polyethylene Insulation • Black PVC Jacket																			
75°C	8221	—	U-500	U-152.4	18.5	8.4	22 AWG	.146	3.71	BC Braid	.242	6.15	80	78%	16.3	53.5	1	.4	1.4
300V RMS (non-UL)			500	152.4	17.0	7.7	(solid)			95% Shield							10	.9	3.0
			U-1000	U-304.8	36.0	16.3	.025"			Coverage							50	2.0	6.6
			1000	304.8	37.0	16.8	BCCS			2.6Ω/M'							100	2.9	9.5
							50.0Ω/M'			8.5Ω/km							200	4.1	13.4
							164.0Ω/km										400	5.9	19.4
																	700	7.8	25.6
																	900	8.8	28.9
																	1000	9.9	32.5

BC = Bare Copper • BCCS = Bare Copper-covered Steel • DCR = DC Resistance
Contact the Belden Customer Service Department for a Comprehensive Connector Cross Reference. **1-800-BELDEN-1**. Request quotations of RG/U cables not listed.

Standard Analog Video Cable

75 Ohm Coax
RG-59/U Type



Description	Part No.	UL NEC/ C(UL) CEC Type	Standard Lengths		Standard Unit Weight		Conductor (stranding) Diameter Nom. DCR	Insulation Diameter		Shielding Materials Nom. DCR	Nominal OD		Nom. Imp. (Ω)	Nom. Vel. of Prop.	Nominal Capacitance		Nominal Attenuation		
			Ft.	m	Lbs.	kg		Inch	mm		Inch	mm			pF/Ft.	pF/m	MHz	dB/ 100 Ft.	dB/ 100m

22 AWG Stranded (7x30) .030" Bare Copper Conductor • Bare Copper Braid Shield (95% Coverage)

Foam Polyethylene Insulation • Black PVC Jacket

UL AWM Style 1354 (30V 80°C) VW-1, FT-1	9659	NEC: CMX CEC: CMX	U-500 U-1000 1000	U-152.4 U-304.8 304.8	19.0 37.0 38.0	8.6 16.8 17.2	22 AWG (7x30) .030"	.146 3.71	3.71	BC Braid 95% Shield Coverage BC 2.6Ω/M' 8.5Ω/km	.242 6.15	6.15	75	78%	17.3 56.7	56.7	1 10 50 100 200 400 700 900 1000	.3 .9 2.1 3.0 4.5 6.6 8.9 10.1 10.9	1.0 3.0 6.9 9.8 14.8 21.6 29.2 33.1 35.8
--	-------------	----------------------------	-------------------------	-----------------------------	----------------------	---------------------	---------------------------	--------------	------	--	--------------	------	----	-----	--------------	------	--	---	--

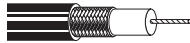

Non-contaminating PVC Jacket. For CCTV, Indoor and Outdoor applications.

UL AWM Style 1354 (30V 80°C) 300V RMS (UL)	9259	NEC: CM CEC: CM	100 U-500 500 U-1000 1000	30.5 U-152.4 152.4 U-304.8 304.8	4.1 8.2 7.5 15.9 16.8	1.9 8.2 7.5 15.9 16.8	22 AWG (7x30) .030"	.146 3.71	3.71	BC Braid 95% Shield Coverage BC 2.6Ω/M' 8.5Ω/km	.241 6.12	6.12	75	78%	17.3 56.7	56.7	1 10 50 100 200 400 700 900 1000	.3 .9 2.1 3.0 4.5 6.6 8.9 10.1 10.9	1.0 3.0 6.9 9.8 14.8 21.7 29.2 33.1 35.8
---	-------------	--------------------------	---------------------------------------	--	-----------------------------------	-----------------------------------	---------------------------	--------------	------	--	--------------	------	----	-----	--------------	------	--	---	--

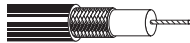

For CCTV, Indoor and Outdoor applications.

Plenum • Foam FEP Insulation • Black FEP Jacket

200°C 300V RMS (UL)	89259	NEC: CMP CEC: CMP FT6	100 500 1000	30.5 152.4 304.8	5.1 16.0 32.0	2.3 7.3 14.5	22 AWG (7x30) .030"	.135 3.43	3.43	BC Braid 95% Shield Coverage BC 2.6Ω/M' 8.5Ω/km	.193 4.90	4.90	75	78%	17.3 56.7	56.7	1 10 50 100 200 400 700 900 1000	.3 .9 2.1 3.0 4.5 6.6 9.0 10.1 11.0	1.0 3.0 6.9 9.8 14.8 21.6 29.5 33.1 36.1
------------------------	--------------	--------------------------------	--------------------	------------------------	---------------------	--------------------	---------------------------	--------------	------	--	--------------	------	----	-----	--------------	------	--	---	--



Suitable for Outdoor and Direct Burial applications.

Plenum • Foam FEP Insulation • Natural Flamarrest® Jacket

75°C 300V RMS (UL)	82259	NEC: CMP CEC: CMP FT6	U-1000 1000	U-304.8 304.8	31.0 30.0	14.1 13.6	22 AWG (7x30) .030"	.135 3.43	3.43	BC Braid 95% Shield Coverage BC 2.6Ω/M' 8.5Ω/km	.193 4.90	4.90	75	78%	17.3 56.7	56.7	1 10 50 100 200 400 700 900 1000	.3 .9 2.1 3.0 4.5 6.6 9.0 10.1 11.0	1.0 3.0 6.9 9.8 14.8 21.6 29.5 33.1 36.1
-----------------------	--------------	--------------------------------	----------------	------------------	--------------	--------------	---------------------------	--------------	------	--	--------------	------	----	-----	--------------	------	--	---	--



BC = Bare Copper • DCR = DC Resistance • FEP = Fluorinated Ethylene Propylene

Contact the Belden Customer Service Department for a Comprehensive Connector Cross Reference. **1-800-BELDEN-1**. Request quotations of RG/U cables not listed.

Standard Analog Video Cable

75 Ohm Coax
RG-59/U Type



Description	Part No.	UL NEC/ C(UL) CEC Type	Standard Lengths		Standard Unit Weight		Conductor (stranding) Diameter Nom. DCR	Nominal Core OD		Shielding Materials Nom. DCR	Nominal OD		Nom. Imp. (Ω)	Nom. Vel. of Prop.	Nominal Capacitance		Nominal Attenuation		
			Ft.	m	Lbs.	kg		Inch	mm		Inch	mm			pF/Ft.	pF/m	MHz	dB/100 Ft.	dB/100m

20 AWG Solid .032" Bare Copper-covered Steel Conductor • Bare Copper Braid Shield (80% Coverage)

Foam Polyethylene Insulation • Black PVC Jacket

75°C	9240	—	1000†	304.8	31.0	14.1	20 AWG (solid) .032" BCCS 44.5Ω/M' 146.0Ω/km	.143	3.63	BC Braid 80% Shield Coverage 5.6Ω/M' 18.4Ω/km	.241	6.12	75	78%	17.3	56.7	1	.6	2.0
																	10	1.0	3.3
																	50	2.1	6.9
																	100	3.0	9.8
																	200	4.5	14.8
																	400	6.6	21.6
																	700	8.9	29.2
																	900	10.1	33.1
																	1000	10.9	35.8

20 AWG Solid .032" Bare Copper-covered Steel Conductor • Bare Copper Braid Shield (95% Coverage)

Foam Polyethylene Insulation • Black Polyethylene Jacket

80°C	8212	—	U-500	U-152.4	16.5	7.5	20 AWG (solid) .032" BCCS 44.5Ω/M' 146.0Ω/km	.143	3.63	BC Braid 95% Shield Coverage 2.6Ω/M' 8.5Ω/km	.242	6.15	75	78%	17.3	56.7	1	.6	2.0
			500	152.4	15.0	6.8											10	1.0	3.3
			U-1000	U-304.8	31.0	14.1											50	2.1	6.9
			1000	304.8	33.0	15.0											100	3.0	9.8
																	200	4.5	14.8
																	400	6.6	21.6
																	700	8.9	29.2
																	900	10.1	33.1
																	1000	10.9	35.8

Foam Polyethylene Insulation • Black PVC Jacket

80°C	9274	NEC: CM CEC: CM	500	152.4	15.5	7.0	20 AWG (solid) .032" BCCS 44.5Ω/M' 146.0Ω/km	.143	3.63	BC Braid 95% Shield Coverage 3.5Ω/M' 11.5Ω/km	.240	6.10	75	82%	16.3	53.5	1	.6	2.0
			1000	304.8	35.0	15.9											10	1.0	3.3
																	50	2.1	6.9
																	100	3.0	9.8
																	200	4.5	14.8
																	400	6.6	21.6
																	700	8.9	29.2
																	900	10.1	33.1
																	1000	10.9	35.8

20 AWG Solid .032" Bare Copper Conductor • Bare Copper Braid Shield (95% Coverage)

Gas-injected Foam HDPE Insulation • Black PVC Jacket

UL AWM Style 1354 (30V 75°C) 60°C (UL)	1426A	NEC: CM	U-1000	U-304.8	35.0	15.9	20 AWG (solid) .032" BC 10.0Ω/M' 32.8Ω/km	.145	3.68	BC Braid 95% Shield Coverage 2.6Ω/M' 8.5Ω/km	.242	6.15	75	83%	16.3	53.5	1	.3	1.0
																	10	.9	3.0
																	50	1.9	6.2
																	100	2.6	8.5
																	200	3.6	11.8
																	400	5.0	16.4
																	700	7.0	23.0
																	900	8.0	26.3
																	1000	8.5	27.9

Series 59 • 20 AWG Solid .032" Bare Copper-covered Steel Conductor • Duofoil® or Duobond® + Aluminum Braid Shield (40% Coverage)

Gas-injected Foam Polyethylene Insulation • Black PVC Jacket

80°C	9275	NEC: CATV CM CEC: CM	U-500	U-152.4	12.0	5.5	20 AWG (solid) .032" BCCS 44.5Ω/M' 146.0Ω/km	.144	3.66	Duofoil + 40% Aluminum Braid 17.0Ω/M' 55.8Ω/km	.237	6.02	75	83%	16.2	53.1	See Chart on page 6.88
			U-1000*	U-304.8	23.0	10.4											
			1000	304.8	24.0	10.9											
																	100% Sweep tested. 5 MHz to 550 MHz.

*U-1000 ft. put-up also available in White.

80°C	9100	NEC: CATV CM CEC: CM	U-500	U-152.4	12.0	5.5	20 AWG (solid) .032" BCCS 44.5Ω/M' 146.0Ω/km	.144	3.66	Duobond II + 40% Aluminum Braid 17.0Ω/M' 55.8Ω/km	.237	6.02	75	83%	16.2	53.1	See Chart on page 6.88
			U-1000*	U-304.8	23.0	10.4											
			1000	304.8	24.0	10.9											
																	100% Sweep tested. 5 MHz to 1 GHz.

*U-1000 ft. put-up also available in White.

BC = Bare Copper • BCCS = Bare Copper-covered Steel • DCR = DC Resistance

Contact the Belden Customer Service Department for a Comprehensive Connector Cross Reference. 1-800-BELDEN-1. Request quotations of RG/U cables not listed.

†Spools and/or UnReel® cartons are one piece, but length may vary ±5% from length shown.



Standard Analog Video Cable

75 Ohm Coax
RG-6/U Type



19 • Brilliance® Broadcast

Description	Part No.	UL NEC/ C(UL) CEC Type	Standard Lengths		Standard Unit Weight		Conductor (stranding) Diameter Nom. DCR	Nominal Core OD		Shielding Materials Nom. DCR	Nominal OD		Nom. Imp. (Ω)	Nom. Vel. of Prop.	Nominal Capacitance		Nominal Attenuation		
			Ft.	m	Lbs.	kg		Inch	mm		Inch	mm			pF/Ft.	pF/m	MHz	dB/100 Ft.	dB/100m

21 AWG Solid .028" Bare Copper-covered Steel Conductor • Bare Copper Double Braid Shields (98% Coverage)

Polyethylene Insulation • Black Polyethylene Jacket																			
MATV Cable 80°C	8215	—	1000	304.8	74.0	33.6	21 AWG (solid) .028"	.185	4.70	(2) BC Braids 98% Shield Coverage	.332	8.43	75	66%	20.5	67.2	1	.4	1.3
							32.0Ω/M'			1.1Ω/M'							10	.8	2.6
							105.0Ω/km			3.6Ω/km							50	1.9	6.2
																	100	2.7	8.9
																	200	4.1	13.4
																	400	5.9	19.4
																	700	8.1	26.6
																	900	9.4	30.8
																	1000	9.8	32.1

18 AWG Solid .037" Bare Copper Conductor • Bare Copper Double Braid Shields (98% Coverage)

Foam Polyethylene Insulation • Black PVC Jacket																			
80°C	9290	NEC: CM CEC: CM	1000 2000	304.8 609.6	59.0 118.0	26.8 53.5	18 AWG (solid) .037"	.180	4.57	(2) BC Braids 98% Shield Coverage	.288	7.32	75	81%	17.3	56.7	1	.2	.7
							7.5Ω/M'			2.0Ω/M'							10	.7	2.3
							24.6Ω/km			6.6Ω/km							50	1.7	5.6
																	100	2.5	8.2
																	200	3.6	11.8
																	400	5.0	16.4
																	700	7.2	23.6
																	900	8.3	27.2
																	1000	8.8	28.9

Suitable for Indoor and Outdoor applications.

18 AWG Solid .040" Bare Copper Conductor • Duofoil® (100% Coverage) + Tinned Copper Braid Shield (60% Coverage)

Gas-injected Foam HDPE Insulation • Black PVC Jacket																			
UL AWM Style 1354 (30V 80°C)	9248	NEC: CM CEC: CM	U-500 500	U-152.4 152.4	16.5 15.0	7.5 6.8	18 AWG (solid) .040"	.180	4.57	Duofoil + 60% TC Braid	.270	6.86	75	82%	16.2	53.1	1	.3	1.0
			U-1000 1000	U-304.8 304.8	32.0 33.0	14.5 15.0	6.4Ω/M'			5.6Ω/M'							10	.7	2.3
			1640 3280	500.0 1000.0	55.8 108.2	25.3 49.2	21.0Ω/km			18.4Ω/km							50	1.5	4.9
																	100	2.0	6.6
																	200	2.8	9.2
																	400	4.0	13.1
																	700	5.3	17.4
																	900	6.1	20.0
																	1000	6.5	21.3

18 AWG Solid .040" Bare Copper Conductor • Duofoil® (100% Coverage) + Tinned Copper Braid Shield (65% Coverage)

Plenum • Foam FEP Insulation • Black FEP Jacket																			
200°C	89248	NEC: CMP CEC: CMP FT6	500 1000 2000	152.4 304.8 609.6	15.0 33.0 64.0	6.8 15.0 29.0	18 AWG (solid) .040"	.170	4.32	Duofoil + 65% TC Braid	.222	5.64	75	82%	16.5	54.1	1	.3	1.0
							6.4Ω/M'			5.1Ω/M'							10	.7	2.3
							21.0Ω/km			16.7Ω/km							50	1.5	4.9
																	100	2.1	6.9
																	200	3.1	10.2
																	400	4.5	14.8
																	700	6.0	19.7
																	900	6.9	22.6
																	1000	7.3	23.9

Suitable for Outdoor and Direct Burial applications.

Plenum • Foam FEP Insulation • Natural Flamarrest® Jacket																			
75°C	82248	NEC: CMP CEC: CMP FT6	U-1000 1000	U-304.8 304.8	29.0 31.0	13.2 14.1	18 AWG (solid) .040"	.170	4.32	Duofoil + 65% TC Braid	.222	5.64	75	82%	16.5	54.1	1	.3	1.0
							6.4Ω/M'			5.1Ω/M'							10	.7	2.3
							21.0Ω/km			16.7Ω/km							50	1.6	5.2
																	100	2.2	7.2
																	200	3.0	9.8
																	400	4.6	15.1
																	700	6.6	21.6
																	900	7.7	25.3
																	1000	8.2	26.9

BC = Bare Copper • BCCS = Bare Copper-covered Steel • DCR = DC Resistance • FEP = Fluorinated Ethylene Propylene • HDPE = High-density Polyethylene • TC = Tinned Copper
Contact the Belden Customer Service Department for a Comprehensive Connector Cross Reference. **1-800-BELDEN-1**. Request quotations of RG/U cables not listed.

Standard Analog Video Cable

75 Ohm Coax
RG-11/U Type



Description	Part No.	UL NEC/ C(UL) CEC Type	Standard Lengths		Standard Unit Weight		Conductor (stranding) Diameter Nom. DCR	Nominal Core OD		Shielding Materials Nom. DCR	Nominal OD		Nom. Imp. (Ω)	Nom. Vel. of Prop.	Nominal Capacitance		Nominal Attenuation		
			Ft.	m	Lbs.	kg		Inch	mm		Inch	mm			pF/Ft.	pF/m	MHz	dB/100 Ft.	dB/100m

18 AWG Stranded (7x26) .048" Tinned Copper Conductor • Bare Copper Braid Shield (97% Coverage)

Flame-retardant Semi-foam Polyethylene Insulation • Black PVC Jacket																			
80°C	8238	NEC: CM CEC: CM	500 1000	152.4 304.8	59.0 117.0	26.8 53.2	18 AWG (7x26) .048" TC 6.1Ω/M' 20.0Ω/km	.285	7.24	BC Braid 97% Shield Coverage 1.2Ω/M' 3.9Ω/km	.405	10.29	75	66%	20.5	67.2	1 10 50 100 200 400 700 900 1000	.2 .7 1.3 2.0 2.9 4.2 5.8 6.8 7.1	.6 2.2 4.3 6.6 9.5 13.8 19.0 22.3 23.3

Suitable for Indoor and Outdoor applications.

Polyethylene Insulation • Black PVC Jacket*																			
60°C	8261	CEC: CXC	500 1000	152.4 304.8	52.5 104.0	23.9 47.3	18 AWG (7x26) .048" TC 6.1Ω/M' 20.0Ω/km	.285	7.24	BC Braid 97% Shield Coverage 1.2Ω/M' 3.9Ω/km	.405	10.29	75	66%	20.5	67.2	1 10 50 100 200 400 700 900 1000	.2 .7 1.3 2.0 2.9 4.2 5.8 6.8 7.1	.6 2.2 4.3 6.6 9.5 13.8 19.0 22.3 23.3

*Non-contaminating PVC jacket. Suitable for Indoor and Outdoor applications.

14 AWG Solid .064" Bare Copper Conductor • Duofoil® (100% Coverage) + Tinned Copper Braid Shield (60% Coverage)

Gas-injected Foam HDPE Insulation • Black PVC Jacket																			
80°C	9292	—	1000	304.8	75.0	36.8	14 AWG (solid) .064" BC 2.6Ω/M' 8.5Ω/km	.280	7.11	Duofoil + 60% TC Braid 3.0Ω/M' 9.8Ω/km	.405	10.29	75	84%	16.1	52.8	1 10 50 100 200 400 700 900 1000	.2 .5 .9 1.3 1.6 2.3 3.3 4.0 4.3	.6 1.6 3.0 4.3 5.3 7.6 10.8 13.1 14.1

Suitable for Indoor and Outdoor applications.

14 AWG Solid .064" Bare Copper Conductor • Duofoil® (100% Coverage) + Tinned Copper Braid Shield (63% Coverage)

Plenum • Foam FEP Insulation • Black FEP Jacket																			
200°C	89292	NEC: CMP CATVP CEC: CMP FT6	500† 1000†	152.4 304.8	40.5 81.0	18.4 36.7	14 AWG (solid) .064" BC 2.5Ω/M' 8.2Ω/km	.274	6.96	Duofoil + 63% TC Braid 3.0Ω/M' 9.8Ω/km	.346	8.79	75	83%	16.2	53.1	1 10 50 100 200 400 700 900 1000	.2 .4 1.0 1.5 2.2 3.3 4.5 5.2 5.5	.5 1.3 3.3 4.9 7.2 10.8 14.8 17.1 18.0

Suitable for Indoor and Outdoor applications.

14 AWG Solid .064" Bare Copper Conductor • Bare Copper Braid Shield (97% Coverage)

Gas-injected Foam HDPE Insulation • Black Polyethylene Jacket																			
80°C	8213	—	500 1000 2000	152.4 304.8 609.6	44.0 87.0 172.0	20.0 39.5 78.2	14 AWG (solid) .064" BC 2.6Ω/M' 8.5Ω/km	.285	7.24	BC Braid 97% Shield Coverage 1.1Ω/M' 3.6Ω/km	.405	10.29	75	84%	16.1	52.8	1 10 50 100 200 400 700 900 1000	.2 .4 .9 1.3 1.9 2.9 4.1 4.8 5.2	.6 1.1 3.0 4.3 6.2 9.5 13.5 15.7 17.1

Suitable for Indoor and Outdoor applications.

BC = Bare Copper • DCR = DC Resistance • FEP = Fluorinated Ethylene Propylene • HDPE = High-density Polyethylene • TC = Tinned Copper

Contact the Belden Customer Service Department for a Comprehensive Connector Cross Reference. **1-800-BELDEN-1**. Request quotations of RG/U cables not listed.

†Spools and/or UnReel® cartons are one piece, but length may vary ±10% from length shown.

Precision Video Cable for Analog and Digital

Overview



Analog Video

Belden® precision video cables are used in critical analog and digital video circuits and high quality applications such as live broadcast in network studios and pre- or post-production facilities. They should be used where superior signal integrity is required.

Precision video cables usually have solid center conductors and dual shields. The dielectrics can either be foamed or solid. Tighter impedance and attenuation tolerances, superior Return Loss (RL) specifications, and improved shielding give precision video cables their no-compromise performance.

The frequency response loss curves of the solid dielectric cables, such as 8281, are different from those with foam dielectric, like 1505A. Therefore, different equalization equipment is necessary and commercially available. Avoid mixing 8281 and 1505A for this reason.

Digital Video

Precision video cables are also recommended for the latest digital video applications. Since its inception in the early '80s, digital broadcast is quickly becoming the preferred video format. The advantages of the digital format are many. Digital is very stable, minimizing equipment adjustments. Copies or reproductions retain the quality of the original. Signal degradation is virtually eliminated, and noise immunity is greatly improved. Digital video is transmitted over a cable in either a Parallel or Serial format.

Parallel Digital Video (D₁, D₂ & D₃)

The Parallel format transmits each bit of an 8 or 10 bit digital word simultaneously or parallel down a separate signal path at a frequency of 27 Mb/s. This type of transmission requires the use of a 100 to 120 ohm 12-1/2 pair data cable (Belden part nos. 8142 or 8112 page 19.56). These cables are limited to a transmission distance of less than 30 meters.

Serial Digital Video (SDI)

The Society of Motion Picture and Television Engineers (SMPTE) has developed two different standards for serial digital transmissions (SDI). A third format that transmits at 540 Mb/s is under development. There is also a European standards body known as ITU (formerly CCIR) that developed the specifications for Europe known as PAL. Each of these specifications differs in frequency and transmission technology, i.e., composite or component.

- **SMPTE 259M** — Covers digital video transmissions of composite NTSC 143 Mb/s (Level A) and PAL 177 Mb/s (Level B). It also covers 525/625 component transmissions of 270 Mb/s (Level C) and 360 Mb/s (Level D).
- **SMPTE 292M** — Covers the newest format for HDTV transmissions at 1.458 Gb/s.
- **SMPTE 344M** — Covers component widescreen transmissions of 540 Mb/s.
- **ITU-R BT.601** — International standard covers component PAL transmissions of 177 Mb/s.

Precision Video Cable for Analog and Digital

Sub-Miniature RG-59/U Type



Description	Part No.	UL NEC/ C(UL) CEC Type	Standard Lengths		Standard Unit Weight		Conductor (stranding) Diameter Nom. DCR	Nominal Core OD		Shielding Materials Nom. DCR	Nominal OD		Nom. Imp. (Ω)	Nom. Vel. of Prop.	Nominal Capacitance		Nominal Attenuation		
			Ft.	m	Lbs.	kg		Inch	mm		Inch	mm			pF/Ft.	pF/m	MHz	dB/100 Ft.	dB/100m

28.5 AWG Solid .012" Bare Copper Conductor • Duobond® (100% Coverage) + Tinned Copper Braid Shield (95% Coverage)

Gas-injected Foam HDPE Insulation • PVC Jacket (Available in 10 colors)*

DigiTruck®	179DT <small>new</small>	NEC:	500 [▲]	152.4	5.0	2.3	28.5 AWG (solid)	.056	1.42	Duobond (100%)	.100	2.54	75	77%	17.4	57.4	1	1.2	3.9
SDI/HDTV		CMR	1000	304.8	8.0	3.6											5	1.9	6.1
Digital Video		CEC:					.012"			+ TC Braid							10	2.4	7.8
75°C		CMG FT4					BC			(95% Cov.)							67.5	5.9	19.3
							108Ω/M'			8.9Ω/M'							71.5	6.0	19.6
							350Ω/km			29.2Ω/km							100	6.9	22.6
																	135	7.9	25.8
																	270	10.8	35.4
																	360	12.5	41.0
																	540	15.4	50.5
																	720	17.9	58.7
																	750	18.3	60.0
																	1000	21.3	69.9
																	1500	26.3	86.3
																	2000	30.8	101.1
																	2250	32.8	107.6
																	3000	38.3	125.7

▲500 ft. put-up available in Black only.

25 AWG Stranded (19x37) .021" Bare Copper Conductor • Duofoil® (100% Coverage) + Tinned Copper Braid Shield (95% Coverage)

Gas-injected Foam HDPE Insulation • PVC Jacket (Available in 10 colors)*

SDI/HDTV	1865A	NEC:	1000	304.8	14.0	6.4	25 AWG (19x37)	.094	2.39	Duofoil (100%)	.150	3.81	75	82%	16.5	54.1	1	.5	1.5
Digital Video		CMR															3.6	1.0	3.1
75°C		CEC:					.021"			+ TC Braid							10	1.6	5.2
		CMG FT4					BC			(95% Cov.)							71.5	3.7	12.1
							27.4Ω/M'			5.4Ω/M'							135	5.0	16.4
							89.9Ω/km			17.7Ω/km							270	7.1	23.3
																	360	8.2	26.9
																	540	10.1	33.1
																	720	11.8	38.7
																	750	12.0	39.4
																	1000	13.9	45.6
																	1500	17.0	55.8
																	2250	20.8	68.2
																	3000	24.0	78.7

23 AWG Solid .023" Bare Copper Conductor • Duofoil (100% Coverage) + Tinned Copper Braid Shield (95% Coverage)

Gas-injected Foam HDPE Insulation • PVC Jacket (Available in 10 colors)*

SDI/HDTV	1855A	NEC:	500 [▲]	152.4	9.0	4.1	23 AWG (solid)	.102	2.59	Duofoil (100%)	.159	4.03	75	82%	16.3	53.5	1	.4	1.3
Digital Video		CMR	1000	304.8	16.0	7.3											3.6	.8	2.6
75°C		CEC:					.023"			+ TC Braid							10	1.2	3.9
		CMG FT4					BC			(95% Cov.)							71.5	3.1	10.0
							20.1Ω/M'			7.6Ω/M'							135	3.8	12.5
							65.9Ω/km			24.9Ω/km							270	5.4	17.7
																	360	6.2	20.3
																	540	7.7	25.3
																	720	9.5	31.1
																	750	9.6	31.5
																	1000	10.5	34.4
																	1500	13.0	42.6
																	2250	16.0	52.5
																	3000	18.5	60.7

▲500 ft. put-up available in Black only.

BC = Bare Copper • DCR = DC Resistance • HDPE = High-density Polyethylene • TC = Tinned Copper

Contact the Belden Customer Service Department for a Comprehensive Connector Cross Reference. **1-800-BELDEN-1**. Request quotations of RG/U cables not listed.

*Available in Brown, Red, Orange, Yellow, Green, Blue, Purple, Gray, White or Black.

Precision Video Cable for Analog and Digital

Miniature RG-59/U Type



19 • Brilliance® Broadcast

Description	Part No.	UL NEC/ C(UL) CEC Type	Standard Lengths		Standard Unit Weight		Conductor (stranding) Diameter Nom. DCR	Insulation Diameter		Shielding Materials Nom. DCR	Nominal OD		Nom. Imp. (Ω)	Nom. Vel. of Prop.	Nominal Capacitance		Nominal Attenuation		
			Ft.	m	Lbs.	kg		Inch	mm		Inch	mm			pF/Ft.	pF/m	MHz	dB/100 Ft.	dB/100m
23 AWG Stranded (7x32) .023" Bare Compacted Copper Conductor* • Tinned Copper Braid Shield (95% Coverage)																			
Polyethylene Insulation • Black Polyethylene Jacket																			
80°C	8279	—	500	152.4	13.0	5.9	23 AWG (7x32)	.146	3.71	TC + 95% Shield	.220	5.59	75	66%	21.0	68.9	1	.4	1.1
			1000	304.8	29.0	13.2	.023" BCC			4.5Ω/M'							3.6	.6	2.0
							19.1Ω/M'			14.8Ω/km							10.0	1.2	3.9
							62.6Ω/km			100% Sweep tested. 5 MHz to 850 MHz.							71.5	3.3	10.8
																	135	4.7	15.4
																	270	6.8	22.3
																	360	8.0	26.2
																	540	9.9	32.5
																	720	11.6	38.0
																	750	11.9	39.0
																	1000	13.8	45.3

23 AWG Solid .022" Bare Copper Conductor • Duofoil® (100% Coverage) + Tinned Copper Braid Shield (95% Coverage)																			
Polyethylene Insulation • Black Polyethylene Jacket																			
80°C	9209	—	U-500	U-152.4	15.0	6.8	23 AWG (solid)	.146	3.71	Duofoil + 95% TC Braid	.220	5.59	75	66%	21.0	68.9	1	.4	1.2
			U-1000	U-304.8	29.0	13.2	.022" BC			4.5Ω/M'							3.6	.5	1.8
							20.4Ω/M'			14.8Ω/km							10.0	1.2	3.8
							66.9Ω/km			100% Sweep tested. 5 MHz to 850 MHz.							71.5	2.9	9.5
																	135	4.0	13.0
																	270	5.6	18.4
																	360	6.6	21.5
																	540	8.3	27.2
																	720	9.7	31.7
																	750	9.9	32.5
																	1000	11.6	38.0

Flame-retardant Semi-foam Polyethylene Insulation • Black PVC Jacket																			
UL AWM Style 1354 (30V 75°C)	9209A	NEC: CMR CEC: CMG FT4	U-1000	U-304.8	35.0	15.9	23 AWG (solid)	.146	3.71	Duofoil + 95% TC Braid	.220	5.59	75	66%	21.0	68.9	1	.4	1.2
							.022" BC			4.5Ω/M'							3.6	.5	1.8
							20.4Ω/M'			14.8Ω/km							10.0	1.2	3.8
							66.9Ω/km			100% Sweep tested. 5 MHz to 850 MHz.							71.5	2.9	9.5
																	135	4.0	13.0
																	270	5.6	18.4
																	360	6.6	21.5
																	540	8.6	28.3
																	720	10.1	33.2
																	750	10.4	34.1
																	1000	12.8	41.9

BC = Bare Copper • BCC = Bare Compacted Copper • DCR = DC Resistance • TC = Tinned Copper

Contact the Belden Customer Service Department for a Comprehensive Connector Cross Reference. **1-800-BELDEN-1**. Request quotations of RG/U cables not listed.

*Compacted conductor combines impedance uniformity of solid conductors and "nick-resistance" of stranded conductor.

Precision Video Cable for Analog and Digital

RG-59/U Type and Double Braided RG-59/U Type



Description	Part No.	UL NEC/ C(UL) CEC Type	Standard Lengths		Standard Unit Weight		Conductor (stranding) Diameter Nom. DCR	Nominal Core OD		Shielding Materials Nom. DCR	Nominal OD		Nom. Imp. (Ω)	Nom. Vel. of Prop.	Nominal Capacitance		Nominal Attenuation		
			Ft.	m	Lbs.	kg		Inch	mm		Inch	mm			pF/Ft.	pF/m	MHz	dB/ 100 Ft.	dB/ 100m

20 AWG Solid .032" Bare Copper Conductor • Duofoil® (100% Coverage) + Tinned Copper Braid Shield (95% Coverage)

Gas-injected Foam HDPE Insulation • PVC Jacket (Available in 10 colors)*

SDI/HDTV Digital Video 75°C	1505A	NEC: CMR CEC: CMG FT4	500 [▲] 1000 [◆] 5000 [◆]	152.4 304.8 1524.0	15.5 35.0 165.0	7.0 15.9 74.8	20 AWG (solid) .032" BC 10.0Ω/M' 32.8Ω/km	.145 3.68	3.68	Duofoil + 95% TC Braid 3.8Ω/M' 12.5Ω/km	.233 5.92	75	83%	16.3 53.5	1 3.6 10 71.5 135 270 360 540 720 750 1000 1500 2250 3000	.3 .6 .9 2.1 2.7 3.8 4.4 5.5 6.4 6.5 7.6 9.3 11.6 13.4	1.0 1.8 2.9 6.9 8.9 12.5 14.4 18.0 21.0 21.3 24.9 30.5 38.0 44.0
-----------------------------------	--------------	--------------------------------	--	--------------------------	-----------------------	---------------------	--	--------------	------	---	--------------	----	-----	--------------	--	---	---

For Plenum version of 1505A, see 1506A.
Also available in bundled versions. See 7794A through 7798A.
100% Sweep tested. 5 MHz to 3 GHz.

*500 ft. put-up available in Black, Red or Blue only.
◆1000 ft. and 5000 ft. put-ups available in all ten colors: Brown, Red, Orange, Yellow, Green, Blue, Purple, Gray, White or Black.

Plenum • Foam FEP Teflon® Insulation • Flamarrest® Jacket (Available in 10 colors)*

SDI/HDTV Digital Video 75°C	1506A	NEC: CMP CEC: CMPT FT6	500 [▼] 1000	152.4 304.8	14.5 29.0	6.6 13.2	20 AWG (solid) .032" BC 10.0Ω/M' 32.8Ω/km	.133 3.38	3.38	Duofoil + 95% TC Braid 3.2Ω/M' 10.5Ω/km	.196 4.98	75	84%	16.1 52.8	1 3.6 10 71.5 135 270 360 540 720 750 1000 1500 2250 3000	.3 .6 1.1 2.3 3.2 4.6 5.3 6.4 7.3 7.5 9.4 12.8 17.5 21.9	1.0 2.0 3.4 7.4 10.5 14.9 17.2 21.0 23.9 24.6 30.8 42.0 57.4 71.8
-----------------------------------	--------------	---------------------------------	--------------------------	----------------	--------------	-------------	--	--------------	------	---	--------------	----	-----	--------------	--	---	--

100% Sweep tested. 5 MHz to 3 GHz.

▼500 ft. put-up available in Black or Natural only.
◆1000 ft. put-up available in all ten colors: Brown, Red, Orange, Yellow, Green, Blue, Purple, Gray, Natural or Black.

22 AWG Stranded (7x29) .031" Bare Compacted Copper Conductor* • Tinned Copper/Bare Copper Double Braid Shield (98% Coverage)

Polyethylene Insulation • PVC Jacket (Matte Red, Blue, Green, Gray or Black)

High-Flex SDI/HDTV Video Patch 75°C	8281F	—	500 [▲] 1000	152.4 304.8	34.5 67.0	15.7 30.4	22 AWG (7x29) .031" BCC 12.2Ω/M' 40.0Ω/km	.198 4.90	4.90	TC Double Braid 98% Shield Coverage 1.7Ω/M' 5.6Ω/km	.305 7.75	75	66%	21.0 68.9	1 3.6 10 71.5 135 270 360 540 720 750 1000	.3 .5 .9 2.5 3.6 5.1 6.0 7.4 8.7 8.9 10.5	.9 1.7 2.9 8.0 11.6 16.7 19.7 24.3 28.5 29.2 34.4
--	--------------	---	--------------------------	----------------	--------------	--------------	--	--------------	------	--	--------------	----	-----	--------------	--	---	---

100% Sweep tested. 5 MHz to 830 MHz.

*500 ft. put-up available in Black only.

22 AWG Stranded (7x29) .031" Bare Compacted Copper Conductor* • Tinned Copper/Bare Copper Double Braid Shield (95% Coverage)

Gas-injected Foam HDPE Insulation • PVC Jacket (Matte Black, Red, Green, Blue, Yellow, White, Orange or Purple)

High-Flex SDI/HDTV Video Patch 75°C	1505F	NEC: CM CEC: CM	1000	304.8	45.0 20.4	20.4	22 AWG (7x29) .031" BCC 12.2Ω/M' 40.0Ω/km	.145 3.68	3.68	TC Double Braid 95% Shield Coverage 2.4Ω/M' 7.8Ω/km	.242 6.15	75	80%	17.0 55.7	1 3.6 10 71.5 135 270 360 540 720 750 1000 1500 2250 3000	.2 .5 .9 2.5 3.5 5.1 6.0 7.4 8.7 8.9 10.5 13.3 16.9 20.3	.7 1.6 2.9 8.2 11.5 16.7 19.7 24.3 28.5 29.2 34.4 43.6 55.4 66.6
--	--------------	--------------------------	------	-------	--------------	------	--	--------------	------	--	--------------	----	-----	--------------	--	---	---

100% Sweep tested. 5 MHz to 3 GHz.

*Compacted conductor combines impedance uniformity of solid conductors and "nick-resistance" of stranded conductor.

BC = Bare Copper • BCC = Bare Compacted Copper • DCR = DC Resistance • FEP = Fluorinated Ethylene Propylene • HDPE = High-density Polyethylene • TC = Tinned Copper
Contact the Belden Customer Service Department for a Comprehensive Connector Cross Reference. **1-800-BELDEN-1**. Request quotations of RG/U cables not listed.

Teflon is a DuPont trademark.



For more information, contact **Belden Technical Support: 1-800-BELDEN-1 • www.belden.com**

Precision Video Cable for Analog and Digital

Double Braided RG-59/U Type



Description	Part No.	UL NEC/ C(UL) CEC Type	Standard Lengths		Standard Unit Weight		Conductor (stranding) Diameter Nom. DCR	Nominal Core OD		Shielding Materials Nom. DCR	Nominal OD		Nom. Imp. (Ω)	Nom. Vel. of Prop.	Nominal Capacitance		Nominal Attenuation		
			Ft.	m	Lbs.	kg		Inch	mm		Inch	mm			pF/Ft.	pF/m	MHz	dB/ 100 Ft.	dB/ 100m

20 AWG Solid .031" Bare Copper Conductor • Tinned Copper/Bare Copper Double Braid Shield (98% Coverage)

Polyethylene Insulation • Gray PVC Jacket †

60°C	9231	NEC:	500	152.4	39.0	17.7	20 AWG (solid) .031"	.198	5.03	TC Double Braid	.305	7.75	75	66%	21.0	68.9	1	.3	1.0
VW-1		CMH	1000	304.8	76.0	34.5											98% Shield Coverage	3.6	.5
		CEC:					9.9Ω/M'			71.5					10.0	.8	2.6		
		CMH FT1					32.5Ω/km			135					71.5	2.0	6.6		
										270					135	3.5	11.5		
										360					270	4.3	14.1		
										540					360	5.0	16.4		
										720					540	6.2	20.3		
										720					720	7.2	23.6		
										750					750	7.4	24.3		
										1000					1000	9.1	29.8		

†Non-contaminating PVC jacket

Polyethylene Insulation • Clear Polyethylene Jacket

Indoor Use 80°C	9141	—	1000	304.8	73.0	33.2	20 AWG (solid) .031"	.200	5.06	TC Double Braid	.305	7.75	75	66%	20.0	65.6	1	.3	1.0
		98% Shield Coverage	3.6	.5	1.6														
							9.9Ω/M'			71.5					10.0	.8	2.6		
							32.5Ω/km			135					71.5	2.0	6.6		
										270					135	3.5	11.5		
										360					270	4.3	14.1		
										540					360	5.0	16.4		
										720					540	6.2	20.3		
										720					720	7.2	23.6		
										750					750	7.4	24.3		
										1000					1000	9.1	29.8		

20 AWG Solid .031" Bare Copper Conductor • Tinned Copper/Bare Copper Double Braid Shield (98% Coverage)

Polyethylene Insulation • Polyethylene Jacket (Available in Red, Yellow, Green, Blue, White, Orange or Black)

80°C	8281	—	500 [▲]	152.4	37.5	17.0	20 AWG (solid) .031"	.198	5.03	TC Double Braid	.305	7.75	75	66%	21.0	68.9	1	.3	.8
		98% Shield Coverage	3.6	.5	1.8														
			1000	304.8	74.0	33.6	9.9Ω/M'			71.5					10.0	.8	2.6		
							32.5Ω/km			135					71.5	2.1	6.9		
										270					135	3.0	9.8		
										360					270	4.3	14.1		
										540					360	5.1	16.6		
										720					540	6.3	20.7		
										720					720	7.4	24.3		
										750					750	7.6	24.9		
										1000					1000	9.2	30.2		

[▲]500 ft. put-up not available in White.

Flame-retardant Semi-Foam Polyethylene Insulation • PVC Jacket (Available in 9 colors)*

UL AWM Style 1354 (30V 80°C)	8281B	NEC:	1000	304.8	84.0	38.1	20 AWG (solid) .031"	.198	5.03	TC Double Braid	.305	7.75	75	66%	21.0	68.9	1	.3	.8
		98% Shield Coverage	3.6	.5	1.8														
		CMR					9.9Ω/M'			71.5					10.0	.8	2.6		
		CEC:					32.5Ω/km			135					71.5	2.1	6.9		
		CMG FT4								270					135	3.0	9.8		
										360					270	4.4	14.4		
										540					360	5.1	16.6		
										720					540	6.6	21.5		
										720					720	7.8	25.4		
										750					750	8.0	26.2		
										1000					1000	10.2	33.5		

*8281B available in Red, Orange, Yellow, Green, Blue, Purple, Gray, White or Black.

20 AWG Solid .031" Bare Copper Conductor • Tinned Copper/Bare Copper Double Braid Shield (98% Coverage)

Plenum • FEP Insulation • Black Fluorocopolymer Jacket

150°C	88281	NEC:	500	152.4	44.5	20.2	20 AWG (solid) .031"	.185	4.70	TC Double Braid	.271	6.88	75	70%	19.0	62.4	1	.2	.7
		98% Shield Coverage	3.6	.5	1.6														
		CMP	1000	304.8	86.0	39.1	9.9Ω/M'			71.5					10.0	.8	2.6		
		CEC:					32.5Ω/km			135					71.5	2.3	7.5		
		CMF FT6								270					135	3.3	10.8		
										360					270	5.1	16.7		
										540					360	6.1	20.0		
										720					540	8.0	26.2		
										720					720	9.7	31.8		
										750					750	10.0	32.8		
										1000					1000	12.3	40.3		

Suitable for Outdoor and Direct Burial applications.

BC = Bare Copper • DCR = DC Resistance • FEP = Fluorinated Ethylene Propylene • TC = Tinned Copper

Contact the Belden Customer Service Department for a Comprehensive Connector Cross Reference. **1-800-BELDEN-1**. Request quotations of RG/U cables not listed.

*Compacted conductor combines impedance uniformity of solid conductors and "nick-resistance" of stranded conductor.



Precision Video Cable for Analog and Digital

Low Loss Serial Digital Coax

RG-6/U and RG-11/U Type



Description	Part No.	UL NEC/ C(UL) CEC Type	Standard Lengths		Standard Unit Weight		Conductor (stranding) Diameter Nom. DCR	Nominal Core OD		Shielding Materials Nom. DCR	Nominal OD		Nom. Imp. (Ω)	Nom. Vel. of Prop.	Nominal Capacitance		Nominal Attenuation		
			Ft.	m	Lbs.	kg		Inch	mm		Inch	mm			pF/Ft.	pF/m	MHz	dB/100 Ft.	dB/100m

RG-6/U Type • 18 AWG Solid .040" Bare Copper Conductor • Duofoil® (100% Coverage) + Tinned Copper Braid Shield (95% Coverage)

Gas-injected Foam HDPE Insulation • PVC Jacket (Available in 10 colors)*

SDI/HDTV	1694A	NEC:	500 [▲]	152.4	20.5	9.3	18 AWG	.180	4.57	Duofoil + 95%	.274	6.96	75	82%	16.2	53.1	1	.2	.8
Digital Video		CMR	1000	304.8	45.0	20.5	(solid)			+ 95%							3.6	.5	1.5
75°C		CEC:	4500	1371.6	202.5	91.9	.040"			TC Braid							10	.7	2.4
		CMG FT4					BC			2.8Ω/M'	For Plenum version of 1694A, see 1695A.						71.5	1.6	5.2
							6.4Ω/M'			9.2Ω/km	Also available in bundled versions. See 7710A through 7713A.						135	2.1	6.9
							21.0Ω/km				100% Sweep tested. 5 MHz to 3 GHz.						270	3.0	9.7
																	360	3.4	11.3
																	540	4.3	13.9
																	720	4.9	16.1
																	750	5.0	16.4
																	1000	5.9	19.3
																	1500	7.3	24.0
																	2250	9.1	30.0
																	3000	10.7	35.0

*500 ft. put-up available in Black only.

Gas-injected Foam HDPE Insulation • Black Low-Smoke, Zero-Halogen Jacket

SDI/HDTV	1694SB	NEC:	1000	304.8	46.0	20.9	18 AWG	.180	4.57	Duofoil + 95%	.274	6.96	75	82%	16.2	53.1	1	.2	.8
Digital Video	new	CMG-LS					(solid)			+ 95%							3.6	.5	1.5
75°C		CEC:					.040"			TC Braid							10	.7	2.4
		CMG-LS FT4					BC			2.8Ω/M'	100% Sweep tested. 5 MHz to 4.5 GHz.						71.5	1.6	5.2
		Limited Smoke					6.4Ω/M'			9.2Ω/km							135	2.1	6.9
							21.0Ω/km										270	3.0	9.7
																	360	3.4	11.3
																	540	4.3	13.9
																	720	4.9	16.1
																	750	5.0	16.4
																	1000	5.9	19.3
																	1500	7.3	24.0
																	2250	9.1	30.0
																	3000	10.7	35.0

Plenum • Foam FEP Teflon® Insulation • Flammarrest® Jacket (Available in 10 colors)**

SDI/HDTV	1695A	NEC:	500 [*]	152.4	20.5	9.3	18 AWG	.170	4.32	Duofoil + 95%	.234	5.94	75	82%	16.2	53.1	1	.2	.8
Digital Video		CMP	1000	304.8	45.0	20.5	(solid)			+ 95%							3.6	.5	1.5
75°C		CEC:					.040"			TC Braid							10	.8	2.5
		CMG FT6					BC			2.8Ω/M'	100% Sweep tested. 5 MHz to 3 GHz.						71.5	1.8	5.8
							6.4Ω/M'			9.2Ω/km							135	2.4	7.9
							21.0Ω/km										270	3.4	11.2
																	360	4.0	13.1
																	540	5.2	17.1
																	720	6.1	20.0
																	750	6.2	20.3
																	1000	7.3	23.9
																	1500	9.2	30.2
																	2250	11.6	38.0
																	3000	13.7	44.9

Black jacket suitable for Indoor, Outdoor and Aerial applications.

*500 ft. put-up available in Black or Natural only.

RG-11/U Type • 14 AWG Solid .064" Bare Copper Conductor • Duofoil (100% Coverage) + Tinned Copper Braid Shield (95% Coverage)

Gas-injected Foam HDPE Insulation • PVC Jacket (Available in 10 colors)*

SDI/HDTV	7731A	NEC:	500 [*]	152.4	46.5	21.1	14 AWG	.280	7.11	Duofoil + 95%	.400	10.2	75	85%	16.0	52.4	1	.2	.5
Digital Video		CMR	1000	304.8	95.0	43.1	(solid)			+ 95%							3.6	.3	1.0
75°C		CEC:	4000	1219.2	388.0	176.0	.064"			TC Braid							10	.5	1.5
		CMG FT4					BC			1.5Ω/M'	100% Sweep tested. 5 MHz to 3 GHz.						71.5	1.1	3.6
							2.5Ω/M'			4.9Ω/km							135	1.5	4.8
							8.2Ω/km										270	2.1	6.9
																	360	2.5	8.0
																	540	3.1	10.0
																	720	3.6	11.7
																	750	3.7	12.0
																	1000	4.3	14.1
																	1500	5.5	18.0
																	2250	6.9	22.6
																	3000	8.2	26.9

*500 ft. put-up available in Red or Black only.

Plenum • Foam FEP Teflon Insulation • Fluorocopolymer Jacket (Available in 10 colors)**

SDI/HDTV	7732A	NEC:	500 [*]	152.4	45.0	20.5	14 AWG	.274	6.96	Duofoil + 95%	.348	8.84	75	83%	16.3	53.5	1	.2	.5
Digital Video		CMP	1000	304.8	90.0	40.8	(solid)			+ 95%							3.6	.3	.9
150°C		CEC:	2000 [▼]	609.6	176.0	80.0	.064"			TC Braid							10	.4	1.3
		CMG FT6					BC			1.6Ω/M'	100% Sweep tested. 5 MHz to 3 GHz.						71.5	1.2	4.1
							2.5Ω/M'			5.3Ω/km							135	1.8	5.8
							8.2Ω/km										270	2.6	8.5
																	360	3.1	10.2
																	540	3.9	12.8
																	720	4.6	15.0
																	750	4.7	15.4
																	1000	5.5	18.0
																	1500	6.9	22.7
																	2250	9.2	30.2
																	3000	10.2	33.5

*500 ft. put-up available in Black or Natural only.

**2000 ft. put-up available in Natural only.

Suitable for Outdoor and Direct Burial applications.

BC = Bare Copper • DCR = DC Resistance • FEP = Fluorinated Ethylene Propylene • HDPE = High-density Polyethylene • TC = Tinned Copper

Teflon is a DuPont trademark.

Contact the Belden Customer Service Department for a Comprehensive Connector Cross Reference. **1-800-BELDEN-1**. Request quotations of RG-U cables not listed.

* Available in Black, Brown, Red, Orange, Yellow, Green, Blue, Purple, Gray or White.

** Available in Black, Brown, Red, Orange, Yellow, Green, Blue, Purple, Gray or Natural.



For more information, contact **Belden Technical Support: 1-800-BELDEN-1 • www.belden.com**

VideoFLEX® Snake Cable for Precision Digital and Analog

Bundled Miniature and RG-59/U Type



Description	Part No.	UL NEC/ C(UL) CEC Type	No. of Cond.	Standard Lengths		Standard Unit Weight		Conductor (stranding) Diameter Nom. DCR	Nominal Core OD		Shielding Materials Nom. DCR	Nominal OD		Nom. Imp. (Ω)	Nom. Vel. of Prop.	Nominal Capacitance		Nominal Attenuation	
				Ft.	m	Lbs.	kg		Inch	mm		Inch	mm			pF/Ft.	pF/m	MHz	dB/ 100 Ft.

Miniature • 23 AWG Solid .023" Bare Copper Conductors • Duofoil® (100% Coverage) + Tinned Copper Braid Shield (95% Coverage)

Gas-injected Foam HDPE Insulation • Overall Matte Black PVC Jacket (Color Code: See chart below)

SDI/HDTV Digital Video (1855A Bundled)	7787A	NEC: CMR CEC: CMG FT4	3	500 1000	152.4 304.8	47.5 94.0	21.6 42.7	23 AWG (solid) .023"	.102 .159	2.55 4.03	Duofoil + 95% TC Braid 7.6Ω/M' 24.9Ω/km	.432	10.97	75	83%	16.5	54.1	1 3.6	.4 .8	1.3 2.6
																		10 71.5	1.2 3.1	3.9 10.0
																		135 270	3.8 5.4	12.5 17.7
																		360 540	6.2 7.7	20.3 25.3
																		720 750	9.1 9.5	29.8 31.2
																		1000 1500	10.5 13.0	34.4 42.6
																		2500 3000	16.9 18.5	55.4 60.7
	7788A	NEC: CMR CEC: CMG FT4	4	1000	304.8	110.0	49.9	same as above	.102 .159	2.55 4.03	same as above	.481	12.22							
	7789A	NEC: CMR CEC: CMG FT4	5	500 1000	152.4 304.8	73.0 142.0	33.1 64.4	same as above	.102 .159	2.55 4.03	same as above	.539	13.69							
	7790A	NEC: CMR CEC: CMG FT4	6	500 1000	152.4 304.8	88.5 176.0	40.2 79.8	same as above	.102 .159	2.55 4.03	same as above	.597	15.16							
	7791A	NEC: CMR CEC: CMG FT4	10	500 1000	152.4 304.8	155.5 304.0	70.5 137.9	same as above	.102 .159	2.55 4.03	same as above	.796	20.22							
	7792A	NEC: CMR CEC: CMG FT4	12	500 1000	152.4 304.8	178.5 367.0	81.0 166.5	same as above	.102 .159	2.55 4.03	same as above	.825	20.96							

Sweep tested 5 MHz to 3 GHz.

RG-59/U Type • 20 AWG Solid .032" Bare Copper Conductors • Duofoil (100% Coverage) + Tinned Copper Braid Shield (95% Coverage)

Gas-injected Foam HDPE Insulation • Overall Matte Black PVC Jacket (Color Code: See chart below)

SDI/HDTV Digital Video (1505A Bundled)	7794A	NEC: CMR CEC: CMG FT4	3	500 1000	152.4 304.8	94.5 187.0	43.0 84.8	20 AWG (solid) .032"	.145 .235	3.68 5.97	Duofoil + 95% TC Braid 3.8Ω/M' 12.5Ω/km	.631	16.03	75	83%	16.2	53.1	1 3.6	.3 .6	1.0 1.8
																		10 71.5	.9 2.1	2.9 6.9
																		135 270	2.7 3.8	8.9 12.5
																		360 540	4.4 5.5	14.4 18.0
																		720 750	6.4 6.5	21.0 21.3
																		1000 1500	7.6 9.4	24.9 30.8
																		2500 3000	12.4 13.8	40.7 45.3
	7795A	NEC: CMR CEC: CMG FT4	4	500 1000	152.4 304.8	116.5 237.0	53.0 107.7	same as above	.145 .235	3.68 5.97	same as above	.706	17.93							
	7796A	NEC: CMR CEC: CMG FT4	5	500 1000	152.4 304.8	153.0 299.0	69.4 135.6	same as above	.145 .235	3.68 5.97	same as above	.790	20.07							
	7798A	NEC: CMR CEC: CMG FT4	10	500 1000	152.4 304.8	319.5 625.0	145.2 284.1	same as above	.145 .235	3.68 5.97	same as above	1.166	29.62							

Sweep tested 5 MHz to 3 GHz.

BC = Bare Copper • DCR = DC Resistance • HDPE = High-density Polyethylene • TC = Tinned Copper

See Connector Reference Guide at www.belden.com for connector recommendations.

Color Code Chart

Cond.	Color	Cond.	Color	Cond.	Color
1	Red	5	Yellow	9	Purple
2	Green	6	Brown	10	Black
3	Blue	7	Orange	11	Pink
4	White	8	Gray	12	Tan



VideoFLEX® Snake Cable for Precision Digital and Analog

RG-59/U and RG-6/U Types



Description	Part No.	UL NEC/ C(UL) CEC Type	No. of Cond.	Standard Lengths		Standard Unit Weight		Conductor (stranding) Diameter	Nominal Core OD		Shielding Materials	Nominal OD		Nom. Imp. (Ω)	Nom. Vel. of Prop.	Nominal Capacitance		Nominal Attenuation		
				Ft.	m	Lbs.	kg		Inch	mm		Inch	mm			pF/Ft.	pF/m	MHz	dB/ 100 Ft.	dB/ 100m

RG-59/U • 20 AWG Solid .032" Bare Copper Conductors • Duofoil® (100% Coverage) + Tinned Copper Braid Shield (95% Coverage)

Plenum • Foam FEP Insulation • Plenum-Grade PVC Jackets (Color Code: See chart below) • **Center Spine • No Overall Jacket**

	300V RMS 1283S3 <small>new</small>	NEC:	3	250	76.2	26.3	11.9	20 AWG	.133	3.38	Duofoil (95%)	.422	10.72	75	83%	16.2	53.1	1	.3	1.0			
		CMP:		500	152.4	54.0	24.5	(solid)			+ TC Braid								3.6	.6	2.0		
		CEC:		1000	304.8	103.0	46.7	.032"			3.8Ω/M'								10	.9	2.9		
			CMP:					BC			12.5Ω/km								71.5	2.1	6.9		
								10.0Ω/M'											135	2.7	8.9		
								32.8Ω/km											270	3.8	12.5		
																			360	4.4	14.4		
																			540	5.5	18.0		
																			720	6.4	21.0		
																			750	6.5	21.3		
	1283S5 <small>new</small>	NEC:	5	250	76.2	43.5	19.7	same	.133	3.38	same	.529	13.44	Sweep tested. 5 MHz to 3 GHz.				1000	7.6	24.9			
CMP:			500	152.4	88.0	39.9	as			as			1500					9.4	30.8				
CEC:			1000	304.8	174.0	78.9	above			above			2500					12.4	40.7				
												3000	13.8					45.3					
	1283S6 <small>new</small>	NEC:	6	250	76.6	59.0	26.8	same	.133	3.38	same	.588	14.94	Sweep tested. 5 MHz to 3 GHz.									
CMP:			500	152.4	108.0	49.0	as			as													
CEC:			1000	304.8	209.0	94.8	above			above													

Suitable for Indoor and Outdoor applications.

RG-6/U Type • 18 AWG Solid .040" Bare Copper Conductors • Duofoil® (100% Coverage) + Tinned Copper Braid Shield (95% Coverage)

Gas-injected Foam HDPE Insulation • Overall Matte Black PVC Jacket (Color Code: See chart below)

	SDI/HDTV Digital Video 75°C/60°C (UL) (1694A Bundled)	7710A	NEC:	3	500	152.4	137.5	62.4	18 AWG	.180	4.57	Duofoil	.770	19.56	75	82%	16.2	53.1	1	.24	.8			
			CMR:		1000	304.8	285.0	129.3	(solid)			Coax OD: + 95%								3.58	.45	1.5		
			CEC:						.040"			.275	6.99	TC Braid						5	.54	1.8		
								BC				3.0Ω/M'							7	.63	2.1			
								6.4Ω/M'				9.9Ω/km							10	.72	2.4			
								21.0Ω/km											67.5	1.57	5.2			
																			71.5	1.60	5.3			
																			88.5	1.75	5.7			
																			100	1.84	6.0			
																			135	2.10	6.9			
	7711A	NEC:	4	500	152.4	179.5	81.4	same	.180	4.57	same	.900	22.86	Sweep tested 5 MHz to 3 GHz.				143	2.16	7.1				
CMR:			1000	304.8	350.0	158.8	as			Coax OD: as												180	2.42	7.9
CEC:							above			.275	6.99	above										270	2.97	9.8
																						360	3.43	11.3
																						540	4.25	13.9
																						720	4.95	16.2
	7712A	NEC:	5	500	152.4	216.5	98.2	same	.180	4.57	same	.970	24.64	Sweep tested 5 MHz to 3 GHz.				750	5.00	16.4				
CMR:			1000	304.8	454.0	205.9	as			Coax OD: as												1000	5.89	19.3
CEC:							above			.275	6.99	above										1500	7.33	24.1
																						2000	8.57	28.1
																						2250	9.14	30.0
																						3000	10.67	35.0
	7713A	NEC:	10	500	152.4	463.0	210.0	same	.180	4.57	same	1.386	35.20	Sweep tested 5 MHz to 3 GHz.										
CMR:			1000	304.8	904.0	410.0	as			Coax OD: as														
CEC:							above			.275	6.99	above												

BC = Bare Copper • DCR = DC Resistance • FEP = Fluorinated Ethylene Propylene • HDPE = High-density Polyethylene • TC = Tinned Copper

Contact the Belden Customer Service Department for a Comprehensive Connector Cross Reference. **1-800-BELDEN-1**. Request quotations of cables not listed. See Connector Reference Guide at www.belden.com for connector recommendations.

Color Code Chart

Cond.	Color	Cond.	Color
1	Red	6	Brown
2	Green	7	Orange
3	Blue	8	Gray
4	White	9	Purple
5	Yellow	10	Black



For more information, contact **Belden Technical Support: 1-800-BELDEN-1 • www.belden.com**

Precision Video Cable for Analog and Digital Parallel Digital Video



Description	Part No.	UL NEC/ C(UL) CEC Type	No. of Pairs	Color Code	Standard Lengths		Standard Unit Weight		Nom. DCR		Nominal OD		Nom. Imp. (Ω)	Nom. Vel. of Prop.	Nom. Capacitance			
					Ft.	m	Lbs.	kg	Cond.	Shield	Inch	mm			* pF/ Ft.	* pF/ m	** pF/ Ft.	** pF/ m

28 AWG Stranded (7x36) TC Conductors • Twisted Pairs • Overall Beldfoil® + TC Braid Shield (65% Coverage) • TC Drain Wire[†]

Datalene® Insulation • Chrome PVC Jacket

UL AWM Style 2919 (30V 80°C)	8142	NEC:	12.5	See	100	30.5	6.8	3.1	65.0Ω/M'	3.1Ω/M'	.375	9.52	120	78%	11.0	36.1	20.0	65.6	
		CL2	(12 pairs + 1 single)	Chart 5	500	152.4	33.0	15.0	213.0Ω/km	10.1Ω/km									
				(Tech Info Section)	1000	304.8	66.0	30.0											

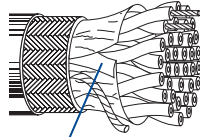

Shorting Fold

24 AWG Stranded (7x32) TC Conductors • Twisted Pairs • Overall Beldfoil + TC Braid Shield (65% Coverage) • TC Drain Wire^{††}

Datalene Insulation • Chrome PVC Jacket

UL AWM Style 2919 (30V 80°C)	8112	NEC: CM	12.5	See	100	30.5	9.2	4.2	24.0Ω/M'	2.4Ω/M'	.440	11.18	100	78%	12.5	41	22	72.2	
		NEC: CM	(12 pairs + 1 single)	Chart 5	500	152.4	51.0	23.1	78.7Ω/km	7.9Ω/km									
				(Tech Info Section)	1000	304.8	101.0	45.8											

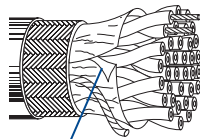

Shorting Fold

DCR = DC Resistance • TC = Tinned Copper

*Capacitance between conductors.

**Capacitance between one conductor and other conductors connected to shield.

† Drain wire is 28 AWG stranded tinned copper

†† Drain wire is 24 AWG stranded tinned copper

Datalene insulation features include low dielectric constant and a dissipation factor for high-speed, low-distortion data handling. Physical properties include good crush resistance and light weight.

Precision Video Cable for Analog and Digital

Digital Video Time Code and
Precision Video Twinax



Description	Part No.	UL NEC/ C(UL) CEC Type	Standard Lengths		Standard Unit Weight		Conductor (stranding) Diameter Nom. DCR	Nominal Core OD		Shielding Materials Nom. DCR	Nominal OD		Nom. Imp. (Ω)	Nom. Vel. of Prop.	Nominal Capacitance		Nominal Attenuation		
			Ft.	m	Lbs.	kg		Inch	mm		Inch	mm			pF/Ft.	pF/m	MHz	dB/100 Ft.	dB/100m
110 Ohm • 26 AWG Stranded (7x34) .018" TC Conductors • Twisted Pair • Beldfoil® Shield (100% Coverage) • 26 AWG Stranded TC Drain Wire																			
Datalene® Insulation (Color Code: Black, White) • PVC Jacket (Chrome or Purple)																			
75°C	9180	NEC: CMR CEC: CMG FT4	1000	304.8	10.0	4.5	26 AWG (7x34) .018" TC 37.3Ω/M' 122.3Ω/km	.049	1.24	Beldfoil w/Stranded TC Drain Wire 23.1Ω/M' 75.8Ω/km	.144	3.66	110	76%	13.0	42.7	.38 .77 1.0 1.5 2.0 3.1 4.1 5.6 8.2 11.3 12.3 24.6	.8 1.2 1.3 1.5 1.7 1.9 2.1 2.4 2.8 3.1 3.2 4.2	.8 4.0 4.3 5.0 5.6 6.3 7.0 8.0 9.3 10.3 10.6 14.0



Twinax • 124 Ohm • 16 AWG Solid .051" BC Conductors • Duofoil® (100% Coverage) + TC Braid Shield (90% Coverage)

Foam Polyethylene Insulation (Color Code: Clear, Blue) • Black PVC Jacket																			
UL AWM Style 2448 (30V 60°C)	9860	NEC: CMX CEC: CMX	500	152.4	52.0	23.6	16 AWG (solid) .051" BC 4.2Ω/M' 13.8Ω/km	.322	8.18	Duofoil + 90% TC Braid 1.3Ω/M' 4.3Ω/km	.440	11.18	124	78%	10.9	35.8	1	.2	.6
			1000	304.8	103.0	46.8											10	.7	2.3
			2000	609.6	202.0	91.8											50	1.8	5.9
																	100	2.9	9.5
																	200	4.1	13.5
																	400	6.2	20.3



BC = Bare Copper • DCR = DC Resistance • TC = Tinned Copper

Contact the Belden Customer Service Department for a Comprehensive Connector Cross Reference. **1-800-BELDEN-1**.

Maximum Transmission Distance at Serial Digital Data Rates

Data Rate:	143 Mb/s		177 Mb/s		270 Mb/s		360 Mb/s		540 Mb/s		1.5 Gb/s	
	SMPTE 259M		ITU-R BT. 601		SMPTE 259M		SMPTE 259M		SMPTE 344M*		SMPTE 292M	
Spec:	Composite NTSC		Composite PAL		Component Video		Component Widescreen		Component Widescreen		HDTV	
Application:	Composite NTSC		Composite PAL		Component Video		Component Widescreen		Component Widescreen		HDTV	
Part No.	Ft.	m	Ft.	m	Ft.	m	Ft.	m	Ft.	m	Ft.	m
1865A	810	247	760	232	600	183	520	158	420	128	170	52
8279	910	277	810	247	640	195	550	168	440	134	170	52
1855A-7787A	1000	305	910	277	750	229	650	198	530	162	210	64
9209	1030	314	930	283	750	229	650	198	540	165	200	61
9209A	1030	314	930	283	750	229	650	198	540	165	200	61
1505A-7794A	1430	436	1320	402	1110	338	960	293	790	241	300	91
1505F	1200	366	1071	326	857	261	732	223	588	179	225	69
1506A	1360	415	1200	366	940	286	810	247	670	204	270	82
9231	1430	436	1270	387	1000	305	850	259	680	207	260	79
9141	1430	436	1270	387	1000	305	850	259	680	207	260	79
8281	1430	436	1270	387	1000	305	860	262	700	213	260	79
8281B	1430	436	1270	387	1000	305	850	259	680	207	250	76
8281F	1250	381	1100	335	860	262	730	222	590	180	240	73
88281	1300	396	1150	351	910	277	770	235	600	183	200	61
1694A-7710A	1760	536	1620	494	1360	415	1180	360	970	296	370	113
1695A	1670	509	1520	463	1250	381	1080	329	880	268	310	94
7855A	2220	677	2000	610	1670	509	1460	445	1210	369	470	143
7731A	2730	832	2460	750	2000	610	1740	530	1430	436	540	165
7732A	2420	738	2140	652	1690	515	1440	439	1150	351	430	131

*Values proposed at time of printing.

The serial digital interconnect standards are designed to operate where the signal loss at 1/2 the clock frequency does not exceed the approximate loss values listed below.

The maximum length values shown are based on typical attenuation values for the cables listed and the following criteria:

Maximum length = 30 dB loss at 1/2 the clock frequency: SMPTE 259M, PAL, Widescreen.

Maximum length = 20 dB loss at 1/2 the clock frequency: SMPTE 292M.

The bit error rate (BER) can vary dramatically as the calculated distances are approached. BER is dependent on receiver design and the losses of the actual coax used.

Distribution and routing equipment manufacturers should be contacted to verify their maximum recommended transmission.

Return Loss Headroom — Refer to graph on page 19.78.



For more information, contact **Belden Technical Support: 1-800-BELDEN-1 • www.belden.com**

Video Triax Cable

RG-59/U Type



Triaxial cable is used to interconnect video cameras to related equipment. Triax cables contain 2 isolated shields and a solid or stranded center conductor. Isolated shields allow the triax to provide multiple functions over 1 cable through multiplexing techniques. Examples include: DC power to camera, intercom to operator, teleprompter feeds, monitoring feeds and even automatic or robotic functions.

Triax is usually either RG-59/U or RG-11/U. The second shield makes the OD of either type larger, so size and flexibility can be an issue. RG-11 styles have lower losses for long runs while RG-59 styles are smaller and generally more flexible. Part numbers 9267 and 9232 are designed with Hypalon® jackets for applications requiring even greater flexibility and ruggedness.

Description	Part No.	UL NEC/ C(UL) CEC Type	Standard Lengths		Standard Unit Weight		Conductor (stranding) Diameter Nom. DCR	Nominal Core OD		Shielding Materials Nom. DCR	Nominal OD		Nom. Imp. (Ω)	Nom. Vel. of Prop.	Nominal Capacitance		Nominal Attenuation		
			Ft.	m	Lbs.	kg		Inch	mm		Inch	mm			pF/Ft.	pF/m	MHz	dB/100 Ft.	dB/100m

22 AWG Stranded (19x34) .031" Bare Copper Conductor • Double Bare Copper Braid Shields (95% Coverage)

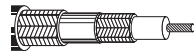
Foam Polyethylene Insulation • Belflex® Jacket (Red, Yellow, Green, Blue, Purple or Black.) Polyethylene Insulation between Braids																																																													
High-Flex 75°C	1857A	—	500	152.4	42.5	19.3	22 AWG (19x34) .031"	.143	3.63	(2) BC Braids 95% Coverage	.360	9.14	75	79%	17.0	55.8	1	.3	1.0																																										
			1000	304.8	86.0	39.1											14.0Ω/M' 45.9Ω/km	2.5Ω/M' 8.2Ω/km	100% Sweep tested. 5 MHz to 3 GHz.	3.6	.5	1.6																																							
																																																													
<table border="0"> <tr> <td>BC</td> <td>71.5</td> <td>2.2</td> <td>7.2</td> </tr> <tr> <td>Inner:</td> <td>135</td> <td>3.1</td> <td>10.2</td> </tr> <tr> <td>Outer:</td> <td>270</td> <td>4.5</td> <td>14.8</td> </tr> <tr> <td></td> <td>360</td> <td>5.4</td> <td>17.7</td> </tr> <tr> <td></td> <td>540</td> <td>6.8</td> <td>22.3</td> </tr> <tr> <td></td> <td>720</td> <td>8.1</td> <td>26.6</td> </tr> <tr> <td></td> <td>750</td> <td>8.4</td> <td>27.6</td> </tr> <tr> <td></td> <td>1000</td> <td>10.1</td> <td>33.1</td> </tr> <tr> <td></td> <td>1500</td> <td>13.3</td> <td>43.6</td> </tr> <tr> <td></td> <td>2250</td> <td>17.6</td> <td>57.7</td> </tr> <tr> <td></td> <td>3000</td> <td>21.4</td> <td>70.2</td> </tr> </table>																		BC	71.5	2.2	7.2	Inner:	135	3.1	10.2	Outer:	270	4.5	14.8		360	5.4	17.7		540	6.8	22.3		720	8.1	26.6		750	8.4	27.6		1000	10.1	33.1		1500	13.3	43.6		2250	17.6	57.7		3000	21.4	70.2
BC	71.5	2.2	7.2																																																										
Inner:	135	3.1	10.2																																																										
Outer:	270	4.5	14.8																																																										
	360	5.4	17.7																																																										
	540	6.8	22.3																																																										
	720	8.1	26.6																																																										
	750	8.4	27.6																																																										
	1000	10.1	33.1																																																										
	1500	13.3	43.6																																																										
	2250	17.6	57.7																																																										
	3000	21.4	70.2																																																										

Suitable for Outdoor applications: Black for permanent installations, all colors for field deployable use.

20 AWG Solid .032" Bare Copper Conductor • Double Bare Copper Braid Shields (80% Coverage)

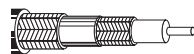
Gas-injected Foam HDPE Insulation • Black Polyethylene Jacket (Polyethylene Insulation between Braids)																																																													
80°C	8232	—	500	152.4	31.0	14.1	20 AWG (solid) .032"	.145	3.68	(2) BC Braids 95% Coverage	.315	8.00	75	83%	16.2	53.1	1	.3	1.0																																										
			1000	304.8	60.0	27.3											10.0Ω/M' 32.8Ω/km	2.5Ω/M' 8.2Ω/km	For Plenum version of 8232, see 88232.	3.6	.6	2.0																																							
																																																													
<table border="0"> <tr> <td>BC</td> <td>71.5</td> <td>2.1</td> <td>6.9</td> </tr> <tr> <td>Inner:</td> <td>135</td> <td>3.0</td> <td>9.8</td> </tr> <tr> <td>Outer:</td> <td>270</td> <td>4.2</td> <td>13.8</td> </tr> <tr> <td></td> <td>360</td> <td>4.8</td> <td>15.7</td> </tr> <tr> <td></td> <td>540</td> <td>5.9</td> <td>19.4</td> </tr> <tr> <td></td> <td>720</td> <td>7.0</td> <td>23.0</td> </tr> <tr> <td></td> <td>750</td> <td>7.1</td> <td>23.3</td> </tr> <tr> <td></td> <td>1000</td> <td>8.3</td> <td>27.2</td> </tr> <tr> <td></td> <td>1500</td> <td>10.5</td> <td>34.4</td> </tr> <tr> <td></td> <td>2250</td> <td>13.4</td> <td>44.0</td> </tr> <tr> <td></td> <td>3000</td> <td>15.9</td> <td>52.2</td> </tr> </table>																		BC	71.5	2.1	6.9	Inner:	135	3.0	9.8	Outer:	270	4.2	13.8		360	4.8	15.7		540	5.9	19.4		720	7.0	23.0		750	7.1	23.3		1000	8.3	27.2		1500	10.5	34.4		2250	13.4	44.0		3000	15.9	52.2
BC	71.5	2.1	6.9																																																										
Inner:	135	3.0	9.8																																																										
Outer:	270	4.2	13.8																																																										
	360	4.8	15.7																																																										
	540	5.9	19.4																																																										
	720	7.0	23.0																																																										
	750	7.1	23.3																																																										
	1000	8.3	27.2																																																										
	1500	10.5	34.4																																																										
	2250	13.4	44.0																																																										
	3000	15.9	52.2																																																										

Suitable for Outdoor and Direct Burial applications.
Suitable for Aerial applications when supported by a messenger wire.

Gas-injected Foam HDPE Insulation • Black PVC Jacket (PVC Insulation between Braids)

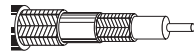
75°C 60°C (UL)	8232A	NEC: CMR CEC: CMG FT4	1000	304.8	68.0	30.8	20 AWG (solid) .032"	.145	3.68	(2) BC Braids 95% Coverage	.315	8.00	75	83%	16.2	53.1	1	.3	1.0																																										
																	10.0Ω/M' 32.8Ω/km	2.5Ω/M' 8.2Ω/km	For Plenum version of 8232A, see 88232.	3.6	.6	2.0																																							
																																																													
<table border="0"> <tr> <td>BC</td> <td>71.5</td> <td>2.1</td> <td>6.9</td> </tr> <tr> <td>Inner:</td> <td>135</td> <td>3.0</td> <td>9.8</td> </tr> <tr> <td>Outer:</td> <td>270</td> <td>4.2</td> <td>13.8</td> </tr> <tr> <td></td> <td>360</td> <td>4.8</td> <td>15.7</td> </tr> <tr> <td></td> <td>540</td> <td>5.9</td> <td>19.4</td> </tr> <tr> <td></td> <td>720</td> <td>7.0</td> <td>23.0</td> </tr> <tr> <td></td> <td>750</td> <td>7.1</td> <td>23.3</td> </tr> <tr> <td></td> <td>1000</td> <td>8.3</td> <td>27.2</td> </tr> <tr> <td></td> <td>1500</td> <td>10.5</td> <td>34.4</td> </tr> <tr> <td></td> <td>2250</td> <td>13.4</td> <td>44.0</td> </tr> <tr> <td></td> <td>3000</td> <td>15.9</td> <td>52.2</td> </tr> </table>																		BC	71.5	2.1	6.9	Inner:	135	3.0	9.8	Outer:	270	4.2	13.8		360	4.8	15.7		540	5.9	19.4		720	7.0	23.0		750	7.1	23.3		1000	8.3	27.2		1500	10.5	34.4		2250	13.4	44.0		3000	15.9	52.2
BC	71.5	2.1	6.9																																																										
Inner:	135	3.0	9.8																																																										
Outer:	270	4.2	13.8																																																										
	360	4.8	15.7																																																										
	540	5.9	19.4																																																										
	720	7.0	23.0																																																										
	750	7.1	23.3																																																										
	1000	8.3	27.2																																																										
	1500	10.5	34.4																																																										
	2250	13.4	44.0																																																										
	3000	15.9	52.2																																																										

Plenum • Foam FEP Insulation • Black FEP Jacket (FEP Insulation between Braids)

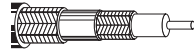
200°C	88232	NEC: CMP CEC: CMP	500†	152.4	29.0	13.2	20 AWG (solid) .032"	.140	3.56	(2) BC Braids 95% Coverage	.245	6.22	75	80%	16.9	55.4	1	.4	1.3																																										
			1000†	304.8	61.0	27.7											10.0Ω/M' 32.8Ω/km	2.6Ω/M' 8.5Ω/km	100% Sweep tested. 5 MHz to 3 GHz.	3.6	.6	2.0																																							
																																																													
<table border="0"> <tr> <td>BC</td> <td>71.5</td> <td>2.2</td> <td>7.2</td> </tr> <tr> <td>Inner:</td> <td>135</td> <td>3.1</td> <td>10.2</td> </tr> <tr> <td>Outer:</td> <td>270</td> <td>4.5</td> <td>14.8</td> </tr> <tr> <td></td> <td>360</td> <td>5.3</td> <td>17.4</td> </tr> <tr> <td></td> <td>540</td> <td>6.6</td> <td>21.6</td> </tr> <tr> <td></td> <td>720</td> <td>7.7</td> <td>25.3</td> </tr> <tr> <td></td> <td>750</td> <td>7.9</td> <td>25.9</td> </tr> <tr> <td></td> <td>1000</td> <td>9.4</td> <td>30.8</td> </tr> <tr> <td></td> <td>1500</td> <td>12.1</td> <td>39.7</td> </tr> <tr> <td></td> <td>2250</td> <td>15.6</td> <td>51.2</td> </tr> <tr> <td></td> <td>3000</td> <td>18.7</td> <td>61.3</td> </tr> </table>																		BC	71.5	2.2	7.2	Inner:	135	3.1	10.2	Outer:	270	4.5	14.8		360	5.3	17.4		540	6.6	21.6		720	7.7	25.3		750	7.9	25.9		1000	9.4	30.8		1500	12.1	39.7		2250	15.6	51.2		3000	18.7	61.3
BC	71.5	2.2	7.2																																																										
Inner:	135	3.1	10.2																																																										
Outer:	270	4.5	14.8																																																										
	360	5.3	17.4																																																										
	540	6.6	21.6																																																										
	720	7.7	25.3																																																										
	750	7.9	25.9																																																										
	1000	9.4	30.8																																																										
	1500	12.1	39.7																																																										
	2250	15.6	51.2																																																										
	3000	18.7	61.3																																																										

BC = Bare Copper • DCR = DC Resistance • FEP = Fluorinated Ethylene Propylene • HDPE = High-density Polyethylene

Contact the Belden Customer Service Department for a Comprehensive Connector Cross Reference. 1-800-BELDEN-1. Request quotations of cables not listed.

†Spools are one piece, but length may vary ±10% from length shown.

Hypalon is a DuPont trademark.



Video Triax Cable

RG-59/U Type



Description	Part No.	UL NEC/ C(UL) CEC Type	Standard Lengths		Standard Unit Weight		Conductor (stranding) Diameter Nom. DCR	Nominal Core OD		Shielding Materials Nom. DCR	Nominal OD		Nom. Imp. (Ω)	Nom. Vel. of Prop.	Nominal Capacitance		Nominal Attenuation		
			Ft.	m	Lbs.	kg		Inch	mm		Inch	mm			pF/Ft.	pF/m	MHz	dB/ 100 Ft.	dB/ 100m

20 AWG Solid .032" Bare Copper Conductor • Double Bare Copper Braid Shields (95% Coverage)

Gas-injected Foam HDPE Insulation • Belflex® Jacket (Red, Yellow, Green, Blue or Black) Polyethylene Insulation between Braids

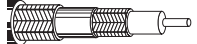
75°C	1856A	—	1000	304.8	83.0	37.7	20 AWG (solid)	.145	3.68	(2) BC Braids 95% Coverage	.360	9.14	75	83%	16.2	53.1	1	.3	1.0
							.032"			Inner: BC							71.5	2.2	7.2
							10.1Ω/M'			2.5Ω/M'							135	3.0	9.8
							33.1Ω/km			8.2Ω/km							270	4.2	13.8
										Outer: 1.6Ω/M'				100% Sweep tested. 5 MHz to 3 GHz.			360	4.8	15.7
										5.3Ω/km							540	5.9	19.4
																	720	6.9	22.6
																	750	7.1	23.3
																	1000	8.8	28.9
																	1500	12.0	39.4
																	2250	16.4	53.8
																	3000	20.4	66.9

Suitable for Outdoor applications: Black for permanent installations, all colors for field deployable use.

Gas-injected Foam HDPE Insulation • Belflex® Jacket (Red, Yellow, Green, Blue, Purple or Black) PVC Insulation between Braids

75°C	1856B	NEC: —	1000	304.8	86.0	39.1	20 AWG (solid)	.145	3.68	(2) BC Braids 95% Coverage	.360	9.14	75	83%	16.2	53.1	1	.3	1.0
60°C (UL)		CMR					.032"			Inner: BC							71.5	2.2	7.2
		GEC: CMG FT4					10.1Ω/M'			2.5Ω/M'							135	3.0	9.8
							33.1Ω/km			8.2Ω/km							270	4.2	13.8
										Outer: 1.6Ω/M'				100% Sweep tested. 5 MHz to 3 GHz.			360	4.8	15.7
										5.2Ω/km							540	5.9	19.4
																	720	6.9	22.6
																	750	7.1	23.3
																	1000	8.8	28.9
																	1500	12.0	39.4
																	2250	16.4	53.8
																	3000	20.4	66.9

Gas-injected Foam HDPE Insulation • Paper Tape Separator • Black Hypalon® Jacket (Polyethylene Insulation between Braids)

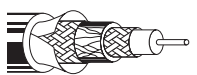
80°C	9267	—	500	152.4	39.5	18.0	20 AWG (solid)	.145	3.68	(2) BC Braids 95% Coverage	.360	9.14	75	82%	16.3	53.5	1	.3	1.0
VW-1			1000	304.8	77.0	35.0	.032"			Inner: BC							71.5	2.1	6.9
							10.1Ω/M'			2.5Ω/M'							135	2.9	9.5
							33.1Ω/km			8.3Ω/km							270	4.2	13.8
										Outer: 2.6Ω/M'				100% Sweep tested. 5 MHz to 3 GHz.			360	4.8	15.7
										8.6Ω/km							540	6.0	19.7
																	720	6.7	22.0
																	750	6.9	22.6
																	1000	8.3	27.2
																	1500	10.5	34.4
																	2250	13.4	44.0
																	3000	15.9	52.2

Suitable for Outdoor and Direct Burial applications.

BC = Bare Copper • DCR = DC Resistance • HDPE = High-density Polyethylene

Contact the Belden Customer Service Department for a Comprehensive Connector Cross Reference. **1-800-BELDEN-1**. Request quotations of cables not listed.

Hypalon is a DuPont trademark.



For more information, contact **Belden Technical Support: 1-800-BELDEN-1 • www.belden.com**

Video Triax Cable

RG-11/U Type



19 • Brilliance® Broadcast

Description	Part No.	UL NEC/ C(UL) CEC Type	Standard Lengths		Standard Unit Weight		Conductor (stranding) Diameter Nom. DCR	Nominal Core OD		Shielding Materials Nom. DCR	Nominal OD		Nom. Imp. (Ω)	Nom. Vel. of Prop.	Nominal Capacitance		Nominal Attenuation		
			Ft.	m	Lbs.	kg		Inch	mm		Inch	mm			pF/Ft.	pF/m	MHz	dB/ 100 Ft.	dB/ 100m

15 AWG Stranded (19x27) .064" Bare Copper Conductor • Double Bare Copper Braid Shield (95% Coverage)

Gas-injected Foam HDPE Insulation • Belflex® Jacket (Red, Yellow, Green, Blue, Purple or Black) Polyethylene Insulation between Braids

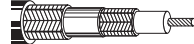
High-Flex 75°C	1858A	—	500	152.4	80.5	36.5	15 AWG (19x27) .064"	.312	7.92	(2) BC Braids 95% Coverage	.520	13.20	75	78%	17.3	56.8	1	.1	.5
			1000	304.8	157.0	71.2											3.6	.3	1.0
																			
BC Inner: 71.5 1.2 3.9 3.1Ω/M' 135 1.8 5.9 8.9Ω/km 270 2.6 8.5 Outer: 360 3.1 10.2 1.4Ω/M' 540 3.9 12.8 4.6Ω/km 720 4.7 15.4 750 4.8 15.7 1000 5.7 18.7																			

Suitable for Outdoor applications: Black for permanent installations, all colors for field deployable use.

Plenum • Foam FEP Teflon® Insulation • Black Fluorocopolymer Jacket (Fluorocopolymer Insulation between Braids)

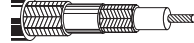
125°C	1859A	NEC:	500	152.4	66.5	30.2	15 AWG (19x27) .064"	.285	7.24	(2) BC Braids 95% Coverage	.406	10.30	75	80%	16.5	54.1	1	.1	.5
		CMP	1000	304.8	134.0	60.9											3.6	.2	.7
																			
CEC: 71.5 1.3 4.3 CMP FT6 135 1.9 6.2 3.1Ω/M' 270 3.0 9.8 8.9Ω/km 4.6Ω/km 360 3.6 11.8 1.4Ω/M' 540 4.5 14.8 4.6Ω/km 720 5.4 17.7 750 5.6 18.4 1000 6.6 21.6																			

Suitable for Outdoor and Direct Burial applications.
Suitable for Aerial applications when supported by a messenger wire.

15 AWG Stranded (19x27) .064" Bare Copper Conductor • Double Bare Copper Braid Shield (90% Coverage)

Gas-injected Foam HDPE Insulation • Yellow PVC Jacket (Polyethylene Insulation between Braids)

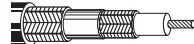
UL AWM Style 1641 (30V 75°C) VW-1	9192	NEC:	1000	304.8	150.0	68.2	15 AWG (19x27) .064"	.312	7.92	(2) BC Braids 90% Coverage	.520	13.20	75	78%	17.3	56.8	1	.1	.5
		CL2X															3.6	.3	1.0
																			
BC 71.5 1.2 3.9 3.1Ω/M' 135 1.8 5.9 8.9Ω/km 270 2.6 8.5 Outer: 360 3.1 10.2 1.6Ω/M' 540 3.9 12.8 5.2Ω/km 720 4.7 15.4 750 4.8 15.7 1000 5.7 18.7																			

Suitable for Outdoor applications: Black for permanent installations, all colors for field deployable use.

Gas-injected Foam HDPE Insulation • Paper Tape Separator • Black Hypalon® Jacket (Polyethylene Insulation between Braids)

UL AWM Style 1641 (30V 75°C) VW-1	9232	—	500	152.4	76.5	34.7	15 AWG (19x27) .064"	.312	7.92	(2) BC Braids 90% Coverage	.520	13.20	75	78%	17.3	56.8	1	.1	.5
			1000	304.8	145.0	65.9											3.6	.3	1.0
																			
BC 71.5 1.2 3.9 3.1Ω/M' 135 1.8 5.9 8.9Ω/km 270 2.6 8.5 Outer: 360 3.1 10.2 1.6Ω/M' 540 3.9 12.8 5.2Ω/km 720 4.7 15.4 750 4.8 15.7 1000 5.7 18.7																			

Suitable for Outdoor and Direct Burial applications.

BC = Bare Copper • DCR = DC Resistance • FEP = Fluorinated Ethylene Propylene • HDPE = High-density Polyethylene

Contact the Belden Customer Service Department for a Comprehensive Connector Cross Reference. **1-800-BELDEN-1**. Request quotations of cables not listed.

Hypalon is a DuPont trademark.
Teflon is a DuPont trademark.



Video Triax Cable

RG-11/U Type



Description	Part No.	UL NEC/ C(UL) CEC Type	Standard Lengths		Standard Unit Weight		Conductor (stranding) Diameter Nom. DCR	Nominal Core OD		Shielding Materials Nom. DCR	Nominal OD		Nom. Imp. (Ω)	Nom. Vel. of Prop.	Nominal Capacitance		Nominal Attenuation		
			Ft.	m	Lbs.	kg		Inch	mm		Inch	mm			pF/Ft.	pF/m	MHz	dB/100 Ft.	dB/100m

14 AWG Solid .064" Bare Copper Conductor • Double Bare Copper Shield (95% Coverage)

Gas-injected Foam HDPE Insulation • Black Polyethylene Jacket (Polyethylene Insulation between Braids)

80°C	8233	—	500	152.4	63.0	28.6	14 AWG (solid)	.285	7.24	(2) BC Braids 95% Coverage	.475	12.07	75	84%	16.1	52.8	1	.2	.7
			1000	304.8	122.0	55.5	.064"			Inner: 2.5Ω/M'							3.6	.3	1.0
			2000	609.6	240.0	109.1	8.2Ω/km			Outer: 1.6Ω/M'							10	.4	1.3
										5.2Ω/km							71.5	1.1	3.6
																	135	1.5	4.9
																	270	2.3	7.5
																	360	2.7	8.9
																	540	3.5	11.5
																	720	4.2	13.8
																	750	4.3	14.1
																	1000	5.2	17.1
																	1500	7.1	23.3
																	2250	9.6	31.5
																	3000	12.0	39.4

Suitable for Outdoor and Direct Burial applications.

Gas-injected Foam HDPE Insulation • Black PVC Jacket (PVC Insulation between Braids)

75°C	8233A	NEC:	1000	304.8	136.0	61.7	14 AWG (solid)	.285	7.24	(2) BC Braids 95% Coverage	.475	12.07	75	84%	16.1	52.8	1	.2	.7
60°C (UL)		CMR:	2000	609.6	266.0	120.7	.064"			Inner: 2.5Ω/M'							3.6	.3	1.0
		CEC:	4000	1219.2	572.0	259.5	8.2Ω/km			Outer: 1.6Ω/M'							10	.4	1.3
		CMG:								5.2Ω/km							71.5	1.1	3.6
																	135	1.5	4.9
																	270	2.3	7.5
																	360	2.7	8.9
																	540	3.5	11.5
																	720	4.2	13.8
																	750	4.3	14.1
																	1000	5.2	17.1
																	1500	7.1	23.3
																	2250	9.6	31.5
																	3000	12.0	39.4

Gas-injected Foam HDPE Insulation • Black Polyethylene Jacket (PE Insulation between Braids; Flooding Compound on Outer Braid)

Flooded	7803A	—	500	152.4	64.0	29.1	14 AWG (solid)	.285	7.24	(2) BC Braids 95% Coverage	.475	12.07	75	84%	16.1	52.8	1	.2	.7
80°C			1000	304.8	123.0	55.9	.064"			Inner: 2.5Ω/M'							3.6	.3	1.0
			3000	914.4	381.0	173.2	8.2Ω/km			Outer: 1.6Ω/M'							10	.4	1.3
										5.2Ω/km							71.5	1.1	3.6
																	135	1.5	4.9
																	270	2.3	7.5
																	360	2.7	8.9
																	540	3.5	11.5
																	720	4.2	13.8
																	750	4.3	14.1
																	1000	5.2	17.1
																	1500	7.1	23.3
																	2250	9.6	31.5
																	3000	12.0	39.4

Suitable for Outdoor and Direct Burial applications.

BC = Bare Copper • DCR = DC Resistance • HDPE = High-density Polyethylene • PE = Polyethylene

Contact the Belden Customer Service Department for a Comprehensive Connector Cross Reference. **1-800-BELDEN-1**. Request quotations of cables not listed.

Audio and Video Composite Camera Cable

Overview



Audio and Video Composite Camera Cables

Audio/video composite cables are used in camera cable applications requiring one or more coaxes for video and one or more shielded pairs for audio and power.

Applications for such cables include interconnect of remote field cameras for Electronic News Gathering (ENG), Electronic Field Production (EFP) and Closed Circuit Television (CCTV).

ENG cameras are used in shooting on-site News reports which may be live or recorded. EFP applications involve on-site recording of videos produced for companies or private enterprises (i.e., advertisement or training films).

The three most common audio/video configurations are one coax-one pair, one coax-three pair and two coax-three pair designs.

One Coax-One Pair

The most common use for cable of this design is the interconnection of cameras requiring one coax for the video connection to the camera and one pair for audio.

The audio pair may be connected either to the camera itself, to an audio junction box or directly into a microphone.

Another common application for this design is the connection of CCTV surveillance cameras where the coax is used for the video connection and the twisted pair to power the camera.

One Coax-Three Pair

This cable is used in camera applications requiring a coaxial video feed, one audio pair for a MIC hook-up, and two audio pairs for the Interrupted Feedback (IFB) connections to the camera person and talent (anchor). IFB is the audio feed(s) to the talent and camera person's headset which enables them to listen and receive information and directions from the news director as they make the recording.

Two Coax-Three Pair

Camera applications utilizing this design again utilize one coax for the camera video connection and three audio pairs for the MIC and IFB hook-ups. The additional coax can be used to provide video to a portable TV monitor so the talent can view him or herself as the report is being recorded.

HDTV Fiber/Copper Composite Cable

Designed specifically for high-definition cameras, these composite cables can multiplex audio and video signals and power. The cables meet all the requirements of the SMPTE 311 standard developed by the Society of Motion Picture and Television Engineers (SMPTE). They are also compatible with industry standard SMPTE 304M connectors.

Audio and Video Composite Camera Cable

SMPTE 311M HDTV Cables

Single-mode Fiber with Copper Conductors



Description	Part No.	UL NEC/ C(UL) CEC Type	Standard Lengths		Standard Unit Weight		Conductor (stranding) Nom. DCR	Nominal Core OD		Shielding Materials Nom. DCR	Nominal OD		Nominal Optical Attenuation (@1310nm)	
			Ft.	m	Lbs.	kg		Inch	mm		Inch	mm	dB/1000 Ft.	dB/km

4 Power Conductors • SM Fiber w/24 and 20 AWG Stranded (7x32 and 19x32) TC Conductors • TC Braid Shield (95% Coverage)

PVC Insulation • Black Belflex® Jacket

	7804R	NEC:	328	100.0	33.1	15.0	(2) Fibers:	.035	.89	36 AWG	.362	9.20	.14	.45
		CMR:	500	152.4	47.5	21.6	SM/125µ/900µ			TC Braid				
		CEC:	1000	304.8	96.0	43.5	(core/clad/buffer)			95% Shield				
		CMG FT4	1640	500.0	152.5	69.2	(2) Cond.:	.050	1.27	Coverage				
			3280	1000.0	314.9	142.8	24 AWG			2.9Ω/M'				
							(7x32)			9.5Ω/km				
						.024"								
						Tinned Copper								
						23.3Ω/M'								
						76.4Ω/km								
						(4) Cond.:	.063	1.60						
						20 AWG								
						(19x32)								
						.037"								
						Tinned Copper								
						8.8Ω/M'								
						28.9Ω/km								

Plenum version and other conductor counts/diameters available by special order.

2 Power Conductors • SM Fiber^ w/24 and 16 AWG Stranded (7x32 and 65x34) TC Conductors • TC Braid Shield (95% Coverage)

PVC Insulation • Black Belflex® Jacket

	7804C	NEC:	328	100.0	32.8	14.9	(2) Breakout	.079	2.00	38 AWG	.362	9.20	.14	.45
		CMR:	500	152.4	49.0	22.2	Fibers:			TC Braid				
		CEC:	1000	304.8	99.0	44.9	SM/125µ/900µ			95% Shield				
		CMG FT4	1640	500.0	157.4	71.4	(core/clad/buffer)			Coverage				
			3280	1000.0	324.7	147.3	(2) Cond.:	.050	1.27	2.8Ω/M'				
							24 AWG			9.2Ω/km				
						(7x32)								
						.024"								
						Tinned Copper								
						23.3Ω/M'								
						76.4Ω/km								
						(2) Cond.:	.093	2.36						
						16 AWG								
						(65x34)								
						.059"								
						Tinned Copper								
						4.3Ω/M'								
						14.1Ω/km								

Plenum version and other conductor counts/diameters available by special order.

▲Fibers and aramid fillers contained within a .008 in (2.0mm) diameter PVC breakout jacket.

DCR = DC Resistance • SM = Single-mode • TC = Tinned Copper

Contact the Belden Customer Service Department for a Comprehensive Connector Cross Reference. **1-800-BELDEN-1**. Request quotations of cables not listed.

Composite Camera Cable

Television Camera and CCTV Cables

RG-59/U Type Coax with Shielded Twisted Pair(s)

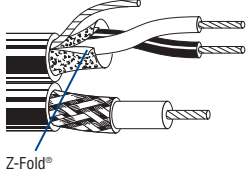

19 • Brilliance® Broadcast

Description	Part No.	UL NEC/ C(UL) CEC Type	Standard Lengths		Standard Unit Weight		Conductor (stranding) Diameter Nom. DCR	Nominal Core OD		Shielding Materials Nom. DCR	Overall Nominal OD		Nom. Imp. (Ω)	Nom. Vel. of Prop.	Nominal Capacitance		Nominal Attenuation		
			Ft.	m	Lbs.	kg		Inch	mm		Inch	mm			pF/Ft.	pF/m	MHz	dB/100 Ft.	dB/100m
22 AWG Stranded (7x30) Conductors • BC Coax w/BC Braid Shield (95% Coverage) • TC Twisted Pair w/Beldfoil® Shield (100% Cov.) + Drain Wire																			
Foam Polyethylene (Coax) and PVC (Pairs) Insulation • Black PVC Jacket																			
UL AWM Style 20006 30V 60°C	9265	NEC: CL2	500 1000	152.4 304.8	32.5 62.0	14.7 28.1	(1) Coax: 22 AWG (7x30) .030" BC 15.0Ω/M' 49.2Ω/km	.146 3.71 .242 6.15	BC Braid 95% Shield Coverage 2.6Ω/M' 8.5Ω/km	.290 7.37 x x .561 14.25	75 78%	75 78%	17.3 56.8	1 5 10 50 100	.3 .7 1.0 2.3 3.3 6.9 9.8	1.0 2.3 3.3 6.9 9.8			
																			
Siamese Type Construction																			

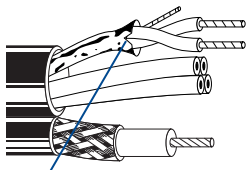
22 AWG Stranded (7x30) Conductors • BC Coax w/BC Braid Shield (95% Cov.) • (3) TC STP Individually Beldfoil Shielded (100% Cov.) w/Drain Wire																			
Foam Polyethylene (Coax) and PVC (Pairs) Insulation • Black PVC Jacket																			
UL AWM Style 20006 30V 60°C	9165	NEC: CL2X	500 1000	152.4 304.8	50.0 94.0	22.7 42.7	(1) Coax: 22 AWG (7x30) .030" BC 15.0Ω/M' 49.2Ω/km	.146 3.71 .242 6.15	BC Braid 95% Shield Coverage 2.6Ω/M' 8.5Ω/km	.290 7.37 x x .561 14.25	75 78%	75 78%	17.3 56.8	1 5 10 50 100 400	.3 .7 1.0 2.3 3.3 6.9 9.8	1.0 2.3 3.3 6.9 9.8			
																			
Siamese Type Construction																			

BC = Bare Copper • DCR = DC Resistance • STP = Shielded Twisted Pairs • TC = Tinned Copper
 Contact the Belden Customer Service Department for a Comprehensive Connector Cross Reference. **1-800-BELDEN-1**. Request quotations of cables not listed.

Composite Camera Cable

Audio and Video, ENG and EFP Cables
Multiple Coax with Shielded Twisted Pairs



Description	Part No.	UL NEC/ C(UL) CEC Type	Standard Lengths		Standard Unit Weight		Conductor (stranding) Diameter Nom. DCR	Nominal Core OD		Shielding Materials Nom. DCR	Nominal OD		Nom. Imp. (Ω)	Nom. Vel. of Prop.	Nominal Capacitance		Nominal Attenuation		
			Ft.	m	Lbs.	kg		Inch	mm		Inch	mm			pF/Ft.	pF/m	MHz	dB/100 Ft.	dB/100m

12-conductor EFP and ENG Camera Cable

Foam Polyethylene (Coax) and Polypropylene (Pairs) Insulation • Overall Chrome PVC Jacket

75°C VW-1	9170	—	1000	304.8	113.0	51.4	(2) Coax: 25 AWG (7x33) .022" BC 31.2Ω/M' 102.0Ω/km Black, Black with Hash Marks	.100	2.54	Each Coax: TC Braid 93% Shield Coverage 6.0Ω/M' 19.7Ω/km	.490	12.45	75	78%	17.3	56.8	1	.4	1.3	10	1.5	4.9	50	3.8	12.5	100	5.6	18.4	300	10.6	34.8	500	13.8	45.3
							(5) Pairs: 24 AWG (7x32) .024" TC 24.0Ω/M' 78.0Ω/km Black & Red, Black & White, Black & Green, Black & Blue, Black & Yellow	.044	1.12	Each Pair: Beldfoil® Shielded 100% Shield Coverage with 24 AWG Drain Wire 18.0Ω/M' 59.1Ω/km			66%	27.0	88.6																			

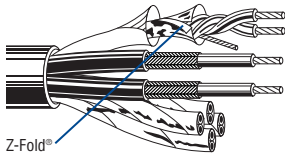

14-conductor EFP and ENG Camera Cable

Foam Polyethylene (Coax) and PVC (Pairs and Conductors) Insulation • Overall Chrome PVC Jacket

75°C	9171	—	500 1000	152.4 304.8	97.5 193.0	44.3 87.7	(2) Coax: 22 AWG (7x30) .030" BC 15.0Ω/M' 49.2Ω/km Black, Black with Hash Marks	.146	3.71	Each Coax: BC Braid 95% Shield Coverage 2.5Ω/M' 8.6Ω/km	.585	14.86	75	78%	17.3	56.8	1	.3	1.0	2	.6	2.0	10	1.0	3.3	50	2.3	7.5	100	3.2	10.5
							(5) Pairs: 22 AWG (7x30) .030" TC 15.0Ω/M' 49.2Ω/km Black & Red, Black & White, Black & Green, Black & Blue, Black & Yellow	.054	1.37	Each Pair: Beldfoil Shielded 100% Shield Coverage with 22 AWG Drain Wire 11.6Ω/M' 38.0Ω/km			51.0	167.3																	
							(2) Cond: 16 AWG (26x30) .060" TC 4.0Ω/M' 13.1Ω/km Black, White	.092	2.34	Each Cond. OD:																					

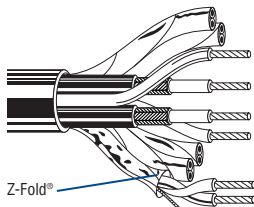

BC = Bare Copper • DCR = DC Resistance • EFP = Electronic Field Production • ENG = Electronic News Gathering • TC = Tinned Copper
Contact the Belden Customer Service Department for a Comprehensive Connector Cross Reference. 1-800-BELDEN-1. Request quotations of cables not listed.

Composite Camera Cable

Television Camera and CCTV Cables



TPE TV Camera Cable

28-Conductor

Product Description

A 75 Ohm cable designed to remain flexible in cold weather. Recommended for transistorized TV cameras.

(4) Conductors — 18 AWG: (16x30) Tinned copper, PVC insulation, ring band stripe color coded. Beldfoil® shield wrapped around four conductors with stranded drain wire. Polyester tape over this shielded group (100% coverage).

(21) Conductors — 22 AWG: (7x30) Tinned copper, PVC insulation, cabled in three groups of seven, ring band stripe color coded. One group of seven has Beldfoil shield wrapped overall with drain wire. Polyester tape over this shielded group (100% coverage). Other two groups are unshielded.

(3) 75 Ohm Coaxial Cables — 25 AWG: (7x33) .021" (.53mm) bare copper-covered steel. Polyethylene insulation. Core OD .121" (3.07mm). Tinned copper braid shield (95% coverage) plus cotton braid. Coax OD .178" (4.52mm).

Overall: Tinned copper braid shield (85% coverage). Black thermoplastic elastomer jacket.

Specifications

Conductor		
(25) Conductors		Tinned Copper
(3) Coax		Bare Copper-covered Steel
Insulation		
Conductors		PVC
Coax		PE
Shield		
(4) 18 AWG Conductors		Beldfoil + PE Tape
(7) 22 AWG Conductors		Beldfoil + PE Tape
(14) 22 AWG Conductors		Unshielded
(3) Coax		95% TC Braid + Cotton Braid
Overall		85% Tinned Copper Braid
Jacket		Black TPE
Nominal OD		.730" (18.54mm)
Nominal Impedance (Coax)		75Ω
Temperature Rating		80°C

Part No.	UL NEC/ C(UL) CEC Type	Standard Lengths		Standard Unit Weight	
		Ft.	m	Lbs.	kg

TPE TV Camera

28-conductor

8286	500†	152.4	163.0	73.9
	1000†	304.8	323.0	146.5

† Spools are one piece, but length may vary -0% to +20% from length shown.

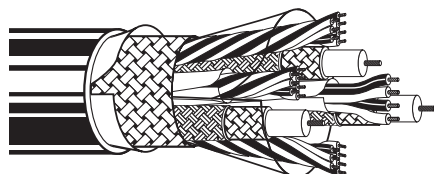

Remote Control and Video Cable

13-Conductor

Product Description

Recommended for use in installations requiring external drive signals, tallies, intercom, switching and video operations. UL recognized component (Style 2594). Passes VW-1 Vertical Wire Flame Test.

(12) Conductors — 20 AWG: (7x28) Tinned copper, PVC insulation, color coded.

(1) 75 Ohm Coaxial — 22 AWG: (7x30) .031" (.79mm) tinned copper. Foam polyethylene insulation. Core OD .146" (3.71mm). Bare copper braid shield (95% coverage). Black PVC jacket. Coax OD .208" (5.28mm).

Overall: Tinned copper braid shield (80% coverage). Gray PVC jacket.

Specifications

Conductor			
(12) Conductors			Tinned Copper
(1) Coax			Tinned Copper
Insulation			
Conductors			PVC
Coax			Foam PE
Shield			
(12) Conductors			Unshielded
(1) Coax			95% Bare Copper Braid
Overall			80% Tinned Copper Braid
Jacket			Gray PVC
Nominal OD			.406" (11.70mm)
Nominal Impedance (Coax)			75Ω
Temperature Rating			60°C/75°C (UL)
Approvals/Rating			
UL AWM Style			2594
NEC Rating			CL2X

Part No.	UL NEC/ C(UL) CEC Type	Standard Lengths		Standard Unit Weight	
		Ft.	m	Lbs.	kg

Remote Control and Video

13-conductor

9262	NEC	100	30.5	15.0	6.8
	CL2X	1000	304.8	160.0	72.6

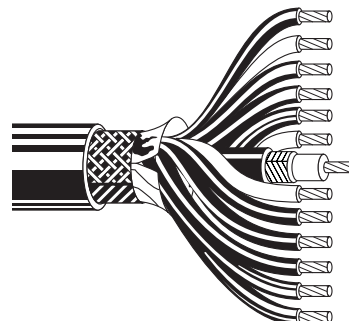

Composite Camera Cable

Television Camera and CCTV Cables



Audio and Video Composite Cable

3 Paired, RG-59U Type

Product Description

Recommended for Electronic News Gathering (ENG) applications.

(3) Pairs — 22 AWG: (7x30) Tinned copper, polypropylene insulation. Nominal insulated conductor OD .046" (1.17 mm). Individually Beldfoil® shielded with drain wire. PVC jacket, OD .125" (3.20mm). Jacket colors: Brown, Red and Orange. Nominal impedance: 50Ω. Nominal velocity of propagation: 66%. Nominal capacitance: 32 pF/ft. (105 pF/m)*, 58 pF/ft. (191 pF/m)**.

(2) 75 Ohm Coaxial Cables — 25 AWG: (7x33) .021" (.53mm) Bare copper. Foam polyethylene insulation. Nominal Core OD .100" (2.54mm). Duofoil® plus tinned copper braid shield (95% coverage). PVC Jacket OD .160" (4.06mm). Jacket colors: Red and Black. Nominal Impedance: 75Ω. Nominal velocity of propagation: 78%. Nominal capacitance: 17.3 pF/ft. (56.8 pF/m). Nominal attenuation value for respective frequencies:

1 MHz	.5 db/100 ft.	1.5 db/100m
5 MHz	1.1 db/100 ft.	3.6 db/100m
10 MHz	1.5 db/100 ft.	4.9 db/100m
50 MHz	3.2 db/100 ft.	10.5 db/100m
100 MHz	4.3 db/100 ft.	14.1 db/100m
300 MHz	10.6 db/100 ft.	34.8 db/100m
500 MHz	13.8 db/100 ft.	45.3 db/100m

Overall: Matte Black PVC jacket.

Specifications

Conductor		
(3) Pairs		Tinned Copper
(2) Coax		Bare Copper
Insulation		
Pairs		Polypropylene
Coax		Foam Polyethylene
Shield		
(3) 22 AWG Pairs		Beldfoil
(2) Coax		Tinned Copper Braid
Jacket		Matte Black PVC
Nominal OD		.492" (12.50mm)
Nominal Impedance (Coax)		75Ω

*Capacitance between conductors.

**Capacitance between one conductor and other conductors connected to shield.

Part No.	UL NEC/ C(UL) CEC Type	Standard Lengths		Standard Unit Weight	
		Ft.	m	Lbs.	kg

Audio and Video Composite Cable

RG-59/U Type • 3 Paired					
1263B	500	152.4	58.5	26.6	
	1000	304.8	113.0	51.4	

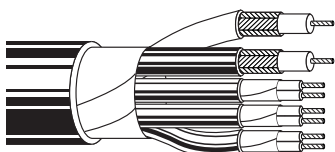

Camera Extension Cable

13-Conductor

Product Description

UL Recognized Component (Style 2497). Recommended for remote control, closed circuit and cue line applications. Style 2497 is specified for the Dage 800 and other similar cameras. Passes VW-1 Vertical Wire Flame Test.

(2) Conductors — 20 AWG: (10x30) Tinned copper, PVC insulation, color coded, twisted pair, Mylar® tape wrapped.

(9) Conductors — 22 AWG: (7x30) Tinned copper, PVC insulation. (2) conductors cabled with Beldfoil shield. (2) conductors cabled, unshielded. (5) conductors unshielded.

(2) 75 Ohm Coaxial Cables — 26 AWG: (7x34) .019" (.48mm) bare copper-covered steel. Foam high-density polyethylene insulation. Core OD .088" (2.24mm). Tinned copper braid shield (95% coverage). PVC jacket, color coded. Coax OD .142" (3.61mm).

Overall: Tinned copper braid shield (85% coverage). Chrome PVC jacket.

Specifications

Conductor			
(11) Conductors			Tinned Copper
(2) Coax			Bare Copper-covered Steel
Insulation			
Conductors			PVC
Coax			Foam PE
Shield			
(7) Conductors			Unshielded
(2) Conductors			Beldfoil
(2) Conductors			Mylar Tape
(2) Coax			95% Tinned Copper Braid
Overall			85% Tinned Copper Braid
Jacket			Chrome PVC
Nominal OD			.550" (13.97mm)
Nominal Impedance (Coax)			75Ω
Temperature Rating			60°C
Approvals/Rating			
UL AWM Style			2497
NEC Rating			CL2X

Part No.	UL NEC/ C(UL) CEC Type	Standard Lengths		Standard Unit Weight	
		Ft.	m	Lbs.	kg

Camera Extension Cable

13-conductor					
9254	NEC	250 [†]	30.5	45.5	20.7
	CL2X	1000 [†]	304.8	177.0	80.5

[†]Spools are one piece, but length may vary -0% to +20% from length shown.

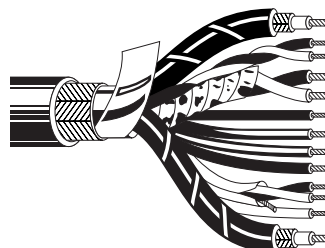

Mylar is a DuPont trademark.



RGB Component Video Cable

Bundled RGB Coaxial Cables Miniature and High-Flex Type



RGB coaxial cables are used for sending red, green and blue signals through separate coaxes in COMPONENT video applications. This type of video transmission provides a sharper, clearer picture than does the composite video format. COMPONENT video and RGB cabling is ideal for use in graphics, animation and computer display applications.

These bundled coaxial cables are available in 3, 4, 5 and 6 conductor versions and are color coded for easy identification. Cable selection depends on whether the component transmission

is RGB (3 conductor), RGB and Sync (4 conductor), or RGB, Sync and Hold (5 conductor). 6 conductor designs are used for digital audio (AES 3id) and SPDIF (Sony-Phillips Digital Interface) applications, and for specialized component video, multi-channel video, or combination applications.

All Belden® RGB cables are pre-timed to less than 5.0 ns/100 ft. delay difference between each coax. This allows for cut-and-connect installation with no TDR or Vectorscope timing required.

Description	Part No.	UL NEC/ C(UL) CEC Type	No. of Cond.	Standard Lengths		Standard Unit Weight		Conductor (stranding) Diameter	Nominal Core OD		Shielding Materials	Nominal OD		Nom. Imp. (Ω)	Nom. Vel. of Prop.	Nominal Capacitance		Nominal Attenuation	
				Ft.	m	Lbs.	kg		Inch	mm		Inch	mm			pF/Ft.	pF/m	MHz	dB/100 Ft.

Miniature • 30 AWG Stranded (7x38) .012" TC Conductors • Coax: Duofoil® (100% Cov.) + TC Braid (90% Cov.) • Overall Beldfoil® Shield
Foam HDPE Insulation • Inner PVC Jackets (Color Code: See chart below) • **Overall Black PVC Jacket**

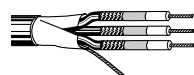
 UL AWM Style 1354 (30V 60°C)	1520A	NEC: CL2	3	500	152.4	23.0	10.4	30 AWG (7x38) .012" TC 100.0Ω/M' 328.0Ω/km	.056	1.42	Coaxes: Duofoil + 90% TC Braid Overall: Beldfoil 9.5Ω/M' 31.2Ω/km	.283	7.19	75	78%	17.3	56.7	1	.8	2.6
				1000	304.8	50.0	22.7		.102	2.59		5	1.5					4.9		
												10	2.2					7.2		
												30	4.0					13.1		
																	50	5.4	17.7	
																		100	8.2	26.9
																		200	12.5	41.0
																		400	18.9	62.0
																		700	26.5	86.9
																		900	30.8	101.0
																		1000	32.8	107.6
	1521A	NEC: CL2	4	500	152.4	31.0	14.1	same as above	.056	1.42	same as above	.310	7.87							
				1000	304.8	60.0	27.3		Coax OD: .102	2.59										
	1522A	NEC: CL2	5	500	152.4	34.5	15.6	same as above	.056	1.42	same as above	.338	8.59							
				1000	304.8	67.0	30.4		Coax OD: .102	2.59										

High-Flex • 26 AWG Stranded (7x34) .019" Bare Copper Conductors • Duofoil (100% Coverage) + TC Braid Shield (93% Coverage)

Foam HDPE Insulation • Inner PVC Jackets (Color Code: See chart below) • **Overall Matte Black PVC Jacket**

 60°C	1406B	—	3	1000†	304.8	79.0	35.8	26 AWG (7x34) .019" BC 41.5Ω/M' 136.0Ω/km	.089	2.29	Duofoil + 93% TC Braid 8.6Ω/M' 28.2Ω/km	.388	9.86	75	78%	17.3	56.7	1	.6	2.0
												5	1.3					4.3		
												10	1.8					5.9		
												30	3.1					10.2		
																		50	3.9	12.8
																		100	5.4	17.7
																		200	7.5	24.6
																		400	10.4	34.1
																		700	13.5	44.3
																		900	15.2	49.9
																		1000	15.9	52.2
	1407B	—	4	1000†	304.8	100.0	45.5	same as above	.089	2.29	same as above	.455	11.56							
									Coax OD: .146	3.71										
	1417B	—	5	1000†	304.8	110.0	49.9	same as above	.089	2.29	same as above	.477	12.12							
									Coax OD: .146	3.71										

BC = Bare Copper • DCR = DC Resistance • HDPE = High-density Polyethylene • TC = Tinned Copper

Contact the Belden Customer Service Department for a Comprehensive Connector Cross Reference. 1-800-BELDEN-1. Request quotations of cables not listed.

†Spools are one piece, but length may vary ±10% from length shown.

Color Code Chart

Cond.	Color
1	Red
2	Green
3	Blue
4	White
5	Yellow



RGB Component Video Cable

Bundled RGB Coaxial Cables

CM Rated



Description	Part No.	UL NEC/ C(UL) CEC Type	No. of Cond.	Standard Lengths		Standard Unit Weight		Conductor (stranding) Diameter Nom. DCR	Nominal Core OD		Shielding Materials Nom. DCR	Nominal OD		Nom. Imp. (Ω)	Nom. Vel. of Prop.	Nominal Capacitance		Nominal Attenuation	
				Ft.	m	Lbs.	kg		Inch	mm		Inch	mm			pF/Ft.	pF/m	MHz	dB/100 Ft.

26 AWG Stranded (7x34) .019" BC Conductors • Duofoil® (100% Coverage) + TC Braid Shield (93% Coverage) • Overall Polyester Tape

Foam HDPE Insulation • Inner PVC Jackets (Color Code: See chart below) • Overall Black PVC Jacket

	UL AWM Styles 1354 and 2668 (30V 60°C)	1164B	NEC:	3	500 [†]	152.4	38.0	17.2	26 AWG (7x34)	.089	2.29	Duofoil	.388	9.86	75	78%	17.3	56.7	1	.6	2.0				
			CM		1000 [†]	304.8	78.0	35.5			Coax OD:		+ 93%								5	1.3	4.3		
											.019"	.146	3.71	TC Braid								10	1.8	5.9	
											BC			8.6Ω/M'								30	3.1	10.2	
											41.5Ω/M'			28.2Ω/km									50	3.9	12.8
											136.1Ω/km												100	5.4	17.7
																							200	7.5	24.6
																							400	10.4	34.1
																							700	13.5	44.3
																							900	15.2	49.9
																				1000	15.9	52.2			
		1167B	NEC:	4	1000 [†]	304.8	105.0	47.7	same as above	.089	2.29	same as above	.455	11.56											
			CM							Coax OD:															
										.146	3.71														
		1418B	NEC:	5	500 [†]	152.4	61.5	27.9	same as above	.089	2.29	same as above	.477	12.12											
			CM		1000 [†]	304.8	119.0	54.0		Coax OD:															
										.146	3.71														

BC = Bare Copper • DCR = DC Resistance • HDPE = High-density Polyethylene • TC = Tinned Copper

Contact the Belden Customer Service Department for a more Comprehensive Connector Cross Reference. **1-800-BELDEN-1**. Request quotations of cables not listed.

[†]Spools are one piece, but length may vary ±10% from length shown.

Color Code Chart

Cond.	Color
1	Red
2	Green
3	Blue
4	White
5	Yellow



RGB Component Video Cable

Miniature Hi-Res Component Video Cables

CMR and CMP Rated



19 • Brilliance® Broadcast

Description	Part No.	UL NEC/ C(UL) CEC Type	No. of Cond.	Standard Lengths		Standard Unit Weight		Conductor (stranding) Diameter Nom. DCR	Nominal Core OD		Shielding Materials Nom. DCR	Nominal OD		Nom. Imp. (Ω)	Nom. Vel. of Prop.	Nominal Capacitance		Nominal Attenuation		
				Ft.	m	Lbs.	kg		Inch	mm		Inch	mm			pF/Ft.	pF/m	MHz	dB/ 100 Ft.	dB/ 100m

Miniature • 25 AWG Solid .018" Tinned Copper Conductors • Duobond® (100% Coverage) + TC Braid Shield (95% Coverage)

Gas-injected Foam HDPE Insulation • Black PVC Jacket

	1281R <small>new</small>	NEC: CMR CEC: CMG	1	1000	304.8	8.0	3.6	25 AWG (solid) .018" TC 34.0Ω/M' 111.6Ω/km	.074	1.88	Duobond (100%) + TC Braid 5.4Ω/M' 17.7Ω/km	.114	2.90	75	80%	17.0	55.8	1	.5	1.7	
																		5	1.2	3.8	
																			50	3.7	12.1
																			100	4.9	16.1
																			200	6.7	22.0
																			400	9.5	31.2
																			700	13.4	44.0
																			900	15.0	49.2
																		1000	15.8	51.8	
																		3000	31.2	102.4	

100% Sweep Tested. 5 MHz to 850 MHz.
Guaranteed Return Loss -20dB Max.

Plenum • PFPA Insulation • Black Flamarrest® Jacket

	1282P <small>new</small>	NEC: CMP CEC: CMP FT6	1	1000	304.8	10.0	4.5	25 AWG (solid) .018" TC 31.8Ω/M' 104.3Ω/km	.074	1.88	Duobond (100%) + TC Braid 5.8Ω/M' 19.0Ω/km	.114	2.90	75	81%	17.0	55.8	1	.4	1.3	
																		5	.9	3.0	
																			50	3.7	12.1
																			100	5.0	16.4
																			200	7.0	23.0
																			400	10.0	32.8
																			700	14.5	47.6
																			900	17.0	55.8
																		1000	17.5	57.4	
																		3000	37.0	121.4	

100% Sweep Tested. 5 MHz to 850 MHz.
Guaranteed Return Loss -20dB Max.

Miniature • 25 AWG Solid .018" Tinned Copper Conductors • Duobond® (100% Coverage) + TC Interlocked Serve Shield (95% Coverage)

PFPA Insulation • PVC Inner Jackets (Color Code: See chart below) • Overall Black Matte PVC Jacket

	1277R <small>new</small>	NEC: CMR CEC: CMG	3	500	152.4	25.5	11.6	25 AWG (solid) .018" TC 34.0Ω/M' 111.6Ω/km	.074	1.88	Duobond (100%) + TC Serve 5.4Ω/M' 17.7Ω/km	Single: .114	2.90	75	80%	17.0	55.8	1	.5	1.7
					1000	304.8	48.0	21.8				Overall: .320	8.13					5	1.2	3.8
																		50	3.7	12.1
																		100	4.9	16.1
																		200	6.7	22.0
																		400	9.5	31.2
																		750	13.4	44.0
																		900	15.0	49.2
																	1000	15.8	51.8	
																	3000	31.2	102.4	
	1278R <small>new</small>	NEC: CMR CEC: CMG	4	500	152.4	31.5	14.3	same as above	.074	1.88	same as above	Overall: .351	8.92					900	15.0	49.2
					1000	304.8	60.0	27.3										1000	15.8	51.8
	1279R <small>new</small>	NEC: CMR CEC: CMG	5	250	76.2	21.8	9.9	same as above	.074	1.88	same as above	Overall: .403	10.24					900	15.0	49.2
					500	152.4	40.5	18.4										1000	15.8	51.8
					1000	304.8	80.0	36.4										3000	31.2	102.4
	1280R <small>new</small>	NEC: CMR CEC: CMG FT4	6	500	152.4	44.0	20.0	same as above	.074	1.88	same as above	Overall: .423	10.74					900	15.0	49.2
					1000	304.8	87.0	39.5										1000	15.8	51.8

Bundled version of 1281R.
100% Sweep Tested. 5 MHz to 850 MHz.
Guaranteed Return Loss -20dB Max.

Plenum • PFPA Insulation • PVDF Inner Jackets (Color Code: See chart below) • Overall Gray PVC Jacket

	1277P <small>new</small>	NEC: CMP CEC: CMP	3	500	152.4	19.0	8.6	25 AWG (solid) .018" TC 34.0Ω/M' 111.6Ω/km	.074	1.88	Duobond (100%) + TC Serve 5.4Ω/M' 17.7Ω/km	Single: .111	2.82	75	81%	16.8	55.1	1	.5	1.6
					1000	304.8	41.0	18.6				Overall: .276	7.01					5	1.2	3.9
																		50	3.8	12.5
																		100	5.2	17.1
																		200	7.1	23.3
																		400	10.0	32.8
																		750	14.3	46.9
																		1000	16.9	55.5
	1278P <small>new</small>	NEC: CMP CEC: CMP	4	500	152.4	27.0	12.3	same as above	.074	1.88	same as above	Overall: .304	7.72					2250	25.5	83.7
					1000	304.8	52.0	23.6										3000	33.9	111.2
	1279P* <small>new</small>	NEC: CMP CEC: CMP	5	250	76.2	19.0	8.6	same as above	.074	1.88	same as above	Overall: .335	8.51					900	15.0	49.2
					500	152.4	33.5	15.2										1000	15.8	51.8
					1000	304.8	68.0	30.8										3000	31.2	102.4
	1280P <small>new</small>	NEC: CMP CEC: CMP	6	500	152.4	39.0	17.7	same as above	.075	1.91	same as above	Overall: .369	9.37					900	15.0	49.2
					1000	304.8	79.0	35.8										1000	15.8	51.8

Bundled version of 1282P.
100% Sweep Tested. 5 MHz to 850 MHz.
Guaranteed Return Loss -20dB Max.

DCR = DC Resistance • PFPA = Foam Perfluoroalkoxy • HDPE = High-density Polyethylene • PVDF = Fluorocopolymer • TC = Tinned Copper
Contact the Belden Customer Service Department for a more Comprehensive Connector Cross Reference: 1-800-BELDEN-1.
Request quotations of cables not listed.

Jacket Color Code Chart:

Cond.	Color	Cond.	Color
1	Red	4	Yellow
2	Green	5	Black
3	Blue	6	White



RGB Component Video Cable

Banana Peel® Unjacketed Bundles Mini Hi-Res Component Video
CMR and CMP Rated



Description	Part No.	UL NEC/ C(UL) CEC Type	No. of Cond.	Standard Lengths		Standard Unit Weight		Conductor (stranding) Diameter Nom. DCR	Nominal Core OD		Shielding Materials Nom. DCR	Nominal OD		Nom. Imp. (Ω)	Nom. Vel. of Prop.	Nominal Capacitance		Nominal Attenuation	
				Ft.	m	Lbs.	kg		Inch	mm		Inch	mm			pF/Ft.	pF/m	MHz	dB/ 100 Ft.

Miniature • 25 AWG Solid .018" TC Conductors • Duobond® (100% Coverage) + TC Interlocked Serve Shield (95% Coverage)

Gas-injected Foam HDPE Insulation • PVC Jackets (Color Code: See chart below) • Center Spine • No Overall Jacket

	1281S3 <small>new</small>	NEC: CMR CEC: CMG	3	500 [†] 1000 [†]	152.4 304.8	17.0 31.0	7.7 14.1	25 AWG (solid) .018" TC 34.0Ω/M' 111.6Ω/km	.074	1.88	Duobond (100%) + TC Serve (95%) 5.4Ω/M' 17.7Ω/km	Single: .114 2.90 Overall: .246 6.25	75	80%	17.0	55.8	1 5 50 100 200 400 750 900 1000 3000	.52 1.2 3.7 4.9 6.7 9.5 13.4 15.0 15.8 31.2	1.6 3.8 12.1 16.1 22.0 31.2 44.0 49.2 51.8 102.4
	1281S4 <small>new</small>	NEC: CMR CEC: CMG	4	500 [†] 1000 [†]	152.4 304.8	23.5 44.0	10.7 20.0	same as above	.074	1.88	same as above	Single: .114 2.90 Overall: .275 6.99							
	1281S5 <small>new</small>	NEC: CMR CEC: CMG	5*	250 [†] 500 [†] 1000 [†]	76.2 152.4 304.8	16.0 28.5 55.0	7.3 12.9 25.0	same as above	.074	1.88	same as above	Single: .114 2.90 Overall: .308 7.82							
	1281S6 <small>new</small>	NEC: CMR CEC: CMG FT4	6*	500 [†] 1000 [†]	152.4 304.8	33.5 68.0	15.2 30.8	same as above	.074	1.88	same as above	Single: .114 2.90 Overall: .342 8.69							

Plenum • FPFA • Flamarrest® Jackets (Color Code: See chart below) • Center Spine • No Overall Jacket

	1282S3 <small>new</small>	NEC: CMP CEC: CMP	3	500 1000	152.4 304.8	18.5 34.0	8.4 15.4	25 AWG (solid) .018" TC 34.0Ω/M' 111.6Ω/km	.075	1.91	Duobond (100%) + TC Serve (95%) 5.4Ω/M' 17.7Ω/km	Single: .114 2.90 Overall: .246 6.25	75	81%	16.8	55.1	1 5 50 100 200 400 750 1000 2250 3000	.50 1.2 3.8 5.2 7.1 10.0 14.3 16.9 25.5 33.9	1.6 3.9 12.1 17.1 23.1 32.9 47.0 55.4 83.6 111.3
	1282S4 <small>new</small>	NEC: CMP CEC: CMP	4	500 1000	152.4 304.8	25.5 49.0	11.6 22.2	same as above	.075	1.91	same as above	Single: .114 2.90 Overall: .275 6.99							
	1282S5 <small>new</small>	NEC: CMP CEC: CMP	5*	250 500 1000	76.2 152.4 304.8	18.0 33.0 67.0	8.2 15.0 30.4	same as above	.075	1.91	same as above	Single: .114 2.90 Overall: .308 7.82							
	1282S6 <small>new</small>	NEC: CMP CEC: CMP	6*	500 1000	152.4 304.8	39.5 80.0	17.9 36.3	same as above	.075	1.91	same as above	Single: .114 2.90 Overall: .342 8.69							

DCR = DC Resistance • FPFA = Foam Perfluoroalkoxy • HDPE = High-density Polyethylene • TC = Tinned Copper

Contact the Belden Customer Service Department for a more Comprehensive Connector Cross Reference. **1-800-BELDEN-1**. Request quotations of cables not listed.

[†]Spools are one piece, but length may vary ±10% from length shown.

*Also available with all Black jackets.

Color Code Chart:

Cond.	Color	Cond.	Color
1	Red	4	Yellow
2	Green	5	Black
3	Blue	6	White



RGB Component Video Cable

Banana Peel® Unjacketed VideoFLEX® Bundles; RG-59/U Type
Plenum Rated



19 • Brilliance® Broadcast

Description	Part No.	UL NEC/ C(UL) CEC Type	No. of Cond.	Standard Lengths		Standard Unit Weight		Conductor (stranding) Diameter Nom. DCR	Nominal Core OD		Shielding Materials Nom. DCR	Nominal OD		Nom. Imp. (Ω)	Nom. Vel. of Prop.	Nominal Capacitance		Nominal Attenuation		
				Ft.	m	Lbs.	kg		Inch	mm		Inch	mm			pF/Ft.	pF/m	MHz	dB/ 100 Ft.	dB/ 100m

RG-59/U • 20 AWG Solid .032" Bare Copper Conductors • Duofoil® (100% Coverage) + Tinned Copper Braid Shield (95% Coverage)

Plenum • Foam FEP Insulation • Plenum-Grade PVC Jackets (Color Code: See chart below) • Center Spine • No Overall Jacket

	300V RMS	1283S3 <small>new</small>	NEC:	3	250	76.2	26.3	11.9	20 AWG	.133	3.38	Duofoil (95%)	.422	10.72	75	83%	16.2	53.1	1	.3	1.0	
			CMP		500	152.4	54.0	24.5	(solid)				+ TC Braid							3.6	.6	2.0
			CEC:		1000	304.8	103.0	46.7	.032"				BC	3.8Ω/M'							10	.9
				CMP					10.0Ω/M'				12.5Ω/km							71.5	2.1	6.9
									32.8Ω/km											135	2.7	8.9
																				270	3.8	12.5
																				360	4.4	14.4
																				540	5.5	18.0
																				720	6.4	21.0
																				750	6.5	21.3
																				1000	7.6	24.9
																				1500	9.4	30.8
																				2500	12.4	40.7
																			3000	13.8	45.3	

100% Sweep tested. 5 MHz to 3 GHz.
U.S. Patent 7,049,523

Suitable for Indoor and Outdoor applications.

BC = Bare Copper • DCR = DC Resistance • FEP = Fluorinated Ethylene Propylene • TC = Tinned Copper

Contact the Belden Customer Service Department for a more Comprehensive Connector Cross Reference. **1-800-BELDEN-1**. Request quotations of cables not listed.

Color Code Chart:

Cond.	Color	Cond.	Color
1	Red	4	Yellow
2	Green	5	Black
3	Blue	6	White



RJ-45 Cables for Audio and Video Applications

4-Pair UTP Cables for RGB Video

NanoSkew™ Non-Data and Brilliance VideoTwist® Low-Skew Data Rated Types



For economy, some system designers seek to use UTP (unshielded twisted pair) cable for video applications. However, Digital Video and Digital Data are processed and viewed differently. Digital Video contains much more information, requiring more bandwidth than Ethernet data. In addition, video has to be streaming — viewable live and continuously — whereas data can be sent in packets, resent as necessary, and given time to recompile. Such delays are unacceptable in video. Be cautious, digital signals are not all the same thing!

Delay Skew should be kept to a minimum for component video and RGB applications for better picture quality and the ability to transmit over longer distances. Delay skew is the difference in the time of arrival of the components transmitted over different cable components — pairs in the case of UTP. Skew is inherent in all cables, but especially in UTP cables because the pairs are normally

twisted to differing degrees for Ethernet data purposes, specifically to reduce crosstalk. Obviously picture clarity is lost when the red, green, and blue components arrive out of time with each other, and varying twist rates cause exactly that to occur.

Cables in this section are NanoSkew, a UTP cable with no Ethernet data rating (all pairs have the same twist rate), and Brilliance VideoTwist Cat 5e and Cat 6 rated cables with lower, carefully monitored skew relative to standard data cables. Cables designed only for data applications meet their own skew requirements, but those are too high for better video transmission, and may be varied by manufacturers without notice. For guaranteed low and consistent skew performance from UTP cables, only NanoSkew or VideoTwist should be used. The Cat 5e and Cat 6 rated versions are ideal for KVM and blade-edge computer applications.

Description	Part No.	UL NEC/ C(UL) CEC Type	No. of Pairs	Standard Lengths		Standard Unit Wt.		Nominal OD		Max. DCR (Ω/100m)	Nom. Imped. (Ω)	Min. RL (dB)	Freq. (MHz)	Max. Atten. (dB/100m)
				Ft.	m	Lbs.	kg	Inch	mm					

Nanoskew™ 24 AWG Solid BC Conductors • Twisted Pairs • Skew 2.2ns/100m nom. • Rip cord • See Color Code Chart (below)

Non-Plenum • Polyolefin Insulation • Maroon PVC Jacket

300V RMS	7987R <small>new</small>	NEC: CMR CEC: CMG	4	U-1000 U-1640	U-304.8 U-500.0	20.0 32.8	9.1 14.9	.195	4.95	9.0	100	15.0	1	2.0
													4	4.1
													8	5.8
													10	6.5
													16	8.2
													20	9.3
													25	10.4
													31.25	11.7
													62.5	17.0
													100	22.0
													155	28.1
													200	32.0
													250*	36.4
													350*	44.8

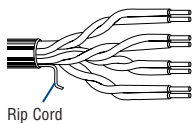

Plenum • FEP Insulation • Maroon Flamarrest® PVC Jacket

300V RMS	7987P <small>new</small>	NEC: CMP CEC: CMP	4	U-1000 U-1640	U-304.8 U-500.0	22.0 36.1	10.0 16.4	.200	5.08	9.0	100	15.0	(same as above)	
----------	------------------------------------	----------------------	---	------------------	--------------------	--------------	--------------	------	------	-----	-----	------	-----------------	--

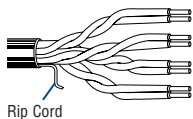

Third party verified to TIA/EIA-568-B.2, Category 5e

BC = Bare Copper • DCR = DC Resistance • FEP = Fluorinated Ethylene Propylene • RL = Return Loss • UTP = Unshielded Twisted Pair(s)

*Values provided for information only.

Color Codes: DataTwist 5e

Pair No.	Color Combination
1	White/Blue Stripe & Blue
2	White/Orange Stripe & Orange
3	White/Green Stripe & Green
4	White/Brown Stripe & Brown



RJ-45 Cables for Audio and Video Applications

4-Pair UTP Cables for RGB Video & Wireless LAN

NanoSkew® Non-Data and Brilliance VideoTwist® Low-Skew Data Rated Types



19 • Brilliance® Broadcast

Description	Part No.	UL NEC/ C(UL) CEC Type	No. of Pairs	Standard Lengths		Standard Unit Wt.		Insulation Thickness		Nominal OD		Max. DCR (Ω/ 100m)	Max. DCR Unbal. (%)	Max. Cap. Unbal. (pF/ 100m)	Freq. (MHz)	Max. Atten. (dB/ 100m)	Min. PSUM NEXT (dB)	Min. PSUM ACR (dB/ 100m)	Min. PSUM ELFEXT (dB/ 100m)	Input Imped. (Ω)	Min. RL (dB)
				Ft.	m	Lbs.	kg	Inch	mm	Inch	mm										

Nanoskew™ Category 5e • 24 AWG Bonded-Pairs Solid Bare Copper Conductors • Skew 9.0ns/100m Nominal • Rip Cord

Non-Plenum • Polyolefin Insulation (Color Code: See Chart Below) • Green PVC Jacket																				
300V RMS	7988R <small>new</small>	NEC: CMR CEC: CMG FT4	4	U-1000 U-1640	U-304.8 U-500.0	22.0 36.1	10.0 16.4	.008 .20	.204	5.18	9.0	3.0	66.0	1	2.0	65.3	60.3	60.8	100±15	20.0
														4	4.1	53.3	49.2	48.7	100±15	23.0
														8	5.8	48.8	43.0	42.7	100±15	24.5
														10	6.5	47.3	40.8	40.8	100±15	25.0
														16	8.2	44.3	36.0	36.7	100±15	25.0
														20	9.3	42.8	33.5	34.7	100±15	25.0
														25	10.4	41.3	30.9	32.8	100±15	24.3
														31.25	11.7	39.9	28.2	30.9	100±15	23.6
														62.5	17.0	35.4	18.4	24.8	100±15	21.5
														100	22.0	32.3	10.3	20.8	100±15	20.1
														155	28.1	29.5	2.0	16.9	100±25	15.8
														200	32.4	27.8	1.0	14.7	100±25	15.0

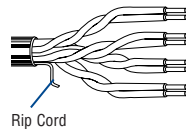

Plenum • FEP Insulation (Color Code: See Chart Below) • Green Flamarrest® Jacket																				
300V RMS	7988P <small>new</small>	NEC: CMP CEC: CMP FT6	4	U-1000 U-1640	U-304.8 U-500.0	23.0 37.7	10.4 17.1	.008 .20	.193	4.90	9.0	3.0	66.0	(same as 7988R above)						

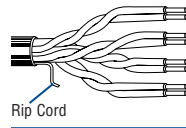

Nanoskew™ Category 6 • 23 AWG Bonded-Pairs Solid Bare Copper Conductors • Skew 10.0ns/100m Nominal • Rip Cord

Non-Plenum • Polypropylene Insulation (Color Code: See Chart Below) • Blue PVC Jacket																				
300V RMS	7989R <small>new</small>	NEC: CMR CEC: CMG FT4	4	1000 1640	304.8 500.0	32.0 52.5	14.5 23.8	.009 .23	.365 .165	9.27 4.19	9.0	3.0	49.2	1	2.0	72.3	70.3	64.8	100±15	20.0
														4	3.8	63.3	59.5	52.7	100±15	23.0
														8	5.3	58.8	53.4	46.7	100±15	24.5
														10	6.0	57.3	51.3	44.8	100±15	25.0
														16	7.6	54.3	46.7	40.7	100±15	25.0
														20	8.5	52.8	44.3	38.7	100±15	25.0
														25	9.5	51.4	41.8	36.8	100±15	24.3
														31.25	10.7	49.9	39.2	34.9	100±15	23.6
														62.5	15.4	45.4	30.0	28.8	100±15	21.5
														100	19.8	42.3	22.5	24.8	100±15	20.1
														155	25.2	39.5	14.3	20.9	100±22	18.8
														200	29.0	37.8	8.8	18.7	100±22	18.0
														250	32.8	36.3	3.5	16.8	100±32	17.3

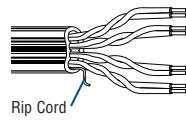

Plenum • FEP Teflon® Insulation (Color Code: See Chart Below) • Blue Flamarrest Jacket																				
300V RMS	7989P <small>new</small>	NEC: CMP CEC: CMP FT6	4	1000 1640	304.8 500.0	41.0 62.3	18.6 28.3	.009 .23	.365 .165	9.27 4.19	9.0	3.0	49.2	(same as 7989R above)						

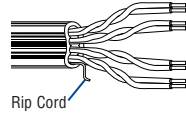

ACR = Attenuation Crosstalk Ratio • BC = Bare Copper • DCR = DC Resistance • ELFEXT = Equal Level Far-end Crosstalk • FEP = Fluorinated Ethylene Propylene • NEXT = Near-end Crosstalk • PSUM = Power Sum • RL = Return Loss • TC = Tinned Copper • UTP = Unshielded Twisted Pair(s)

Not RoHS compliant at time of printing. Please check with Belden Technical Support for current compliance information at 1-800-BELDEN-1.

Teflon is a DuPont trademark.

Color Codes

Pair No.	Color Combination
1	White/Blue Stripe & Blue
2	White/Orange Stripe & Orange
3	White/Green Stripe & Green
4	White/Brown Stripe & Brown

RJ-45 Cables for Audio and Video Applications

4-Pair ScTP Cat 5e Indoor/Outdoor for Wireless LAN and High-Flex and Rugged Cat 5e Patch Cable



Description	Part No.	UL NEC/ C(UL) CEC Type	No. of Pairs	Standard Lengths		Standard Unit Wt.		Insulation Thickness		Nominal OD		Max. DCR (Ω/100m)	Max. DCR Unbal. (%)	Max. Cap. Unbal. (pF/100m)	Freq. (MHz)	Max. Atten. (dB/100m)	Min. PSUM NEXT (dB)	Min. PSUM ACR (dB/100m)	Min. PSUM ELFEXT (dB/100m)	Input Imped. (Ω)	Min. RL (dB)
				Ft.	m	Lbs.	kg	Inch	mm	Inch	mm										

Wireless LAN • 24 AWG Solid BC Conductors • Twisted Pairs • Overall Beldfoil Shield (100% Coverage) • Stranded TC Drain Wire

Non-Plenum • Polyolefin Insulation (Color Code: See Chart Below) • **Oil- and Sun-Resistant Black PVC Jacket**

300V RMS	1300A <small>new</small>	NEC: CMR, CMX CEC: CMG FT4	4	500	152.4	18.5	8.4	.010	.25	.265	6.73	9.3	3.0	330	1	2.0	62.3	60.0	60.8	100±15	20.0
Drain Wire				1000	304.8	34.0	15.4								4	4.1	53.3	49.0	48.7	100±15	23.0
Rip Cord															8	5.8	48.8	43.0	42.7	100±15	24.5
															10	6.5	47.3	41.0	40.8	100±15	25.0
															16	8.2	44.3	36.0	36.7	100±15	25.0
															20	9.3	42.8	33.5	34.7	100±15	25.0
															25	10.4	41.3	30.9	32.8	100±15	24.3
															31.25	11.7	39.9	28.0	30.9	100±15	23.6
															62.5	17.0	35.4	19.0	24.8	100±15	21.5
															100	22.0	32.3	11.0	20.8	100±15	20.1

Shield bonded to jacket. Jacket sequentially marked at 2 ft. intervals.

Non-Plenum • Polypropylene Insulation (Color Code: See Chart Below) • **Black Low-Smoke, Zero-Halogen Jacket**

300V RMS	1300SB <small>new</small>	NEC: CMG-LS CEC: CMG-LS FT4 Limited Smoke	4	1000	304.8	35.0	15.9	.010	.25	.260	6.60	9.3	3.0	330	1	2.0	62.3	60.3	60.8	100±15	20.0
Drain Wire															4	4.1	53.3	49.2	48.7	100±15	23.0
															8	5.8	48.8	43.0	42.7	100±15	24.5
															10	6.5	47.3	40.8	40.8	100±15	25.0
															16	8.2	44.3	36.1	36.7	100±15	25.0
															20	9.3	42.8	33.5	34.7	100±15	25.0
															25	10.4	41.3	30.9	32.8	100±15	24.3
															31.25	11.7	39.9	28.2	30.9	100±15	23.6
															62.5	17.0	35.4	18.4	24.8	100±15	21.5
															100	22.0	32.3	10.3	20.8	100±15	20.1

LSZH and ABS Type Approved
Jacket sequentially marked at 2 ft. intervals.

Hi-Flex Patch • 24 AWG Bonded Pairs Stranded (7x32) Bare Copper Conductors

Non-Plenum • Polyolefin Insulation (Color Code: See Chart Below) • **Black Industrial-Grade PVC Jacket**

300V RMS	1304A <small>new</small>		4	500	152.4	14.5	6.6	.009	.22	.245	6.22	9.0	3.0	66	1	2.4	65.3	62.9	60.8	100±12	20.0
				1000	304.8	28.0	12.7								4	4.8	56.3	51.5	48.7	100±12	23.0
															8	6.8	51.8	45.0	42.7	100±12	24.5
															10	7.7	50.3	42.6	40.8	100±12	25.0
															16	9.7	47.3	37.5	36.7	100±12	25.0
															20	11.0	45.8	34.8	34.7	100±12	25.0
															25	12.4	44.3	31.9	32.8	100±15	24.3
															31.25	13.9	42.9	29.0	30.9	100±15	23.6
															62.5	20.2	38.4	18.3	24.8	100±15	21.5
															100	26.0	35.3	9.2	20.8	100±18	20.1
															300	48.6	28.2	—	11.2	100±20	18.0
															350	53.2	27.2	—	9.9	100±22	17.0

Jacket sequentially marked at 2 ft. intervals.

Non-Plenum • Polyolefin Insulation (Color Code: See Chart Below) • **PVC Inner Jacket • Matte Black PVC Outer Jacket**

300V RMS	1305A <small>new</small>		4	500	152.4	23.0	10.4	.009	.22	.295	7.49	9.0	3.0	66	1	2.4	65.3	62.9	60.8	100±12	20.0
				1000	304.8	42.0	19.1								4	4.8	56.3	51.5	48.7	100±12	23.0
															8	6.8	51.8	45.0	42.7	100±12	24.5
															10	7.7	50.3	42.6	40.8	100±12	25.0
															16	9.7	47.3	37.5	36.7	100±12	25.0
															20	11.0	45.8	34.8	34.7	100±12	25.0
															25	12.4	44.3	31.9	32.8	100±15	24.3
															31.25	13.9	42.9	29.0	30.9	100±15	23.6
															62.5	20.2	38.4	18.3	24.8	100±15	21.5
															100	26.0	35.3	9.2	20.8	100±18	20.1
															300	48.6	28.2	—	11.2	100±20	18.0
															350	53.2	27.2	—	9.9	100±22	17.0

Jacket sequentially marked at 2 ft. intervals.

ACR = Attenuation Crosstalk Ratio • BC = Bare Copper • DCR = DC Resistance • ELFEXT = Equal Level Far-end Crosstalk • FEP = Fluorinated Ethylene Propylene • NEXT = Near-end Crosstalk • PSUM = Power Sum • RL = Return Loss • TC = Tinned Copper • UTP = Unshielded Twisted Pair(s)

Teflon is a DuPont trademark.

Color Codes

Pair No.	Color Combination
1	White/Blue Stripe & Blue
2	White/Orange Stripe & Orange
3	White/Green Stripe & Green
4	White/Brown Stripe & Brown



S-Video Cable

High-Flex S-Video Cables



The S-video format, also known as Y/C or Super VHS (SVHS) video, requires two coaxial cables to allow for separate transmission of the two parts of a VHS video signal; the luminance (Y) and chrominance (C). The chrominance signal contains the color information and the luminance the black and white or brightness information of the video signal. This separated transmission of the VHS video signal provides better picture resolution with less noise than does the standard VHS format.

Belden's S-Video cables have been designed specifically for use in this format. Belden's S-Video cables are available in two popular constructions; a Zip style dual coax and a Round jacketed version. The Zip construction provides for quick and easy termination. The Round design provides better aesthetics and is more rugged. Both cables are highly flexible.

Description	Part No.	UL NEC/ C(UL) CEC Type	Standard Lengths		Standard Unit Weight		Conductor (stranding) Diameter Nom. DCR	Nominal Core OD		Shielding Materials Nom. DCR	Nominal OD		Nom. Imp. (Ω)	Nom. Vel. of Prop.	Nominal Capacitance		Nominal Attenuation		
			Ft.	m	Lbs.	kg		Inch	mm		Inch	mm			pF/Ft.	pF/m	MHz	dB/100 Ft.	dB/100m

30 AWG Stranded (7x38) .012" Tinned Copper Conductors • Tinned Copper Serve Shield (90% Coverage)

Foam HDPE Insulation • Matte Black PVC Jacket (One Coax Printed and Striped for Identification)																						
Parallel Zip Construction	1807A	—	U-500	U-152.4	8.0	3.6	30 AWG (7x38) .012" TC	.058	1.47	TC Serve	.110	2.79	75	78%	17.3	56.7	1	.6	2.0			
			500	152.4	7.5	3.4											90% Shield	x	x	5	1.4	4.6
			U-1000	U-304.8	15.0	6.8											Coverage	.230	5.84	10	2.1	6.9
			1000	304.8	14.0	6.4											TC			30	3.8	12.5
																	100.0Ω/M'			50	5.1	16.7
																	328.0Ω/km			100	7.6	24.9
																	For Plenum version of 1807A, see 7700A.					
																200	11.3	37.1				
																400	16.9	55.4				
																700	23.3	76.4				
																900	26.9	88.2				
																1000	28.6	93.8				

Foam HDPE Insulation • Matte Black PVC Jacket (Inner PVC Jackets Color Code: Black and Yellow)																						
Round Construction	1808A	—	U-500	U-152.4	14.5	6.6	30 AWG (7x38) .012" TC	.058	1.47	TC Serve	.255	.84	75	78%	17.3	56.7	1	.6	2.0			
			500	152.4	16.5	7.5											90% Shield			5	1.4	4.6
			U-1000	U-304.8	31.0	14.1											Coverage	.100	2.54	10	2.1	6.9
			1000	304.8	33.0	15.0											TC			30	3.8	12.5
																	100.0Ω/M'			50	5.1	16.7
																	328.0Ω/km			100	7.6	24.9
																	Available in Plenum versions by special order only.					
																200	11.3	37.1				
																400	16.9	55.4				
																700	23.3	76.4				
																900	26.9	88.2				
																1000	28.6	93.8				

30 AWG Stranded (7x38) .012" Tinned Copper Conductors • Tinned Copper "French Braid" Shield (98% Coverage)

Plenum • Foam FEP Teflon® Insulation • Black Flamarrest® Jacket (One Coax Printed and Striped for Identification)																						
Parallel Zip Construction	7700A	NEC: 500 CMP: 1000 CEC: CMP FT6	U-500	U-152.4	8.5	3.9	30 AWG (7x38) .012" TC	.053	1.35	TC	.107	2.72	75	78%	17.3	56.7	1	.7	2.3			
			500	152.4	17.0	7.7											"French Braid"	x	x	5	1.7	5.6
			U-1000	U-304.8	34.0	15.4											98% Shield	.214	5.44	10	2.3	7.5
			1000	304.8	36.0	16.3											Coverage			30	4.1	13.4
																	100.0Ω/M'			50	5.3	17.4
																	328.0Ω/km			100	7.6	24.9
																	Available in Plenum versions by special order only.					
																200	11.8	38.7				
																400	17.6	57.7				
																700	24.2	79.4				
																900	28.0	91.8				
																1000	29.8	97.7				

DCR = DC Resistance • FEP = Fluorinated Ethylene Propylene • HDPE = High-density Polyethylene • TC = Tinned Copper

Contact the Belden Wire & Cable Customer Service Department for a more Comprehensive Connector Cross Reference. **1-800-BELDEN-1**. Request quotations of cables not listed.

Teflon is a DuPont trademark.



For more information, contact Belden Technical Support: **1-800-BELDEN-1** • www.belden.com

Technical Information



Maximum Transmission Distance at Serial Digital Data Rates

Data Rate:		143 Mb/s		177 Mb/s		270 Mb/s		360 Mb/s		540 Mb/s		1.5 Gb/s		3.0 Gb/s	
Spec:		SMPTE 259M		ITU-R BT. 601		SMPTE 259M		SMPTE 259M		SMPTE 344M		SMPTE 292M		SMPTE 292M	
Application:		Composite NTSC		Composite PAL		Component Video		Component Widescreen		Component Widescreen		HDTV		Progressive Scan HDTV	
Part No.	Ft.	m	Ft.	m	Ft.	m	Ft.	m	Ft.	m	Ft.	m	Ft.	m	
179DT	500	152	450	137	380	116	340	104	280	85	110	34	80	24	
1855A	980	299	950	290	790	241	680	207	560	171	260	79	150	46	
1505A	1430	436	1360	415	1110	338	970	296	790	241	310	94	220	67	
8281	1430	436	1280	390	1000	305	870	265	700	213	260	79	160	49	
1694A	1880	573	1710	521	1430	436	1240	378	1010	308	400	122	270	82	
7855A	2730	832	2330	710	1670	509	1480	451	1200	366	470	143	330	101	
7731A	2750	838	2480	756	2040	622	1760	536	1430	436	550	168	360	110	

The serial digital interconnect standards are designed to operate where the signal loss at 1/2 the clock frequency does not exceed the approximate loss values listed below. The maximum length values shown are based on typical attenuation values for the cables listed and the following criteria:

- Maximum length = 30 dB loss at 1/2 the clock frequency: SMPTE 259M, PAL, Widescreen.
- Maximum length = 20 dB loss at 1/2 the clock frequency: SMPTE 292M.

The bit error rate (BER) can vary dramatically as the calculated distances are approached. BER is dependent on receiver design and the losses of the actual coax used. Distribution and routing equipment manufacturers should be contacted to verify their maximum recommended transmission.

Return Loss Headroom (1694A)

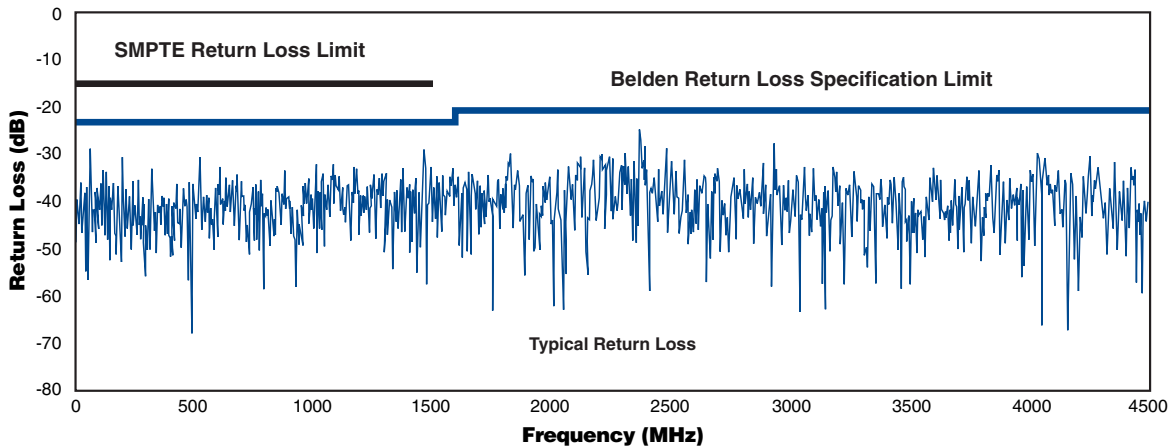



New Generation® Cables

20

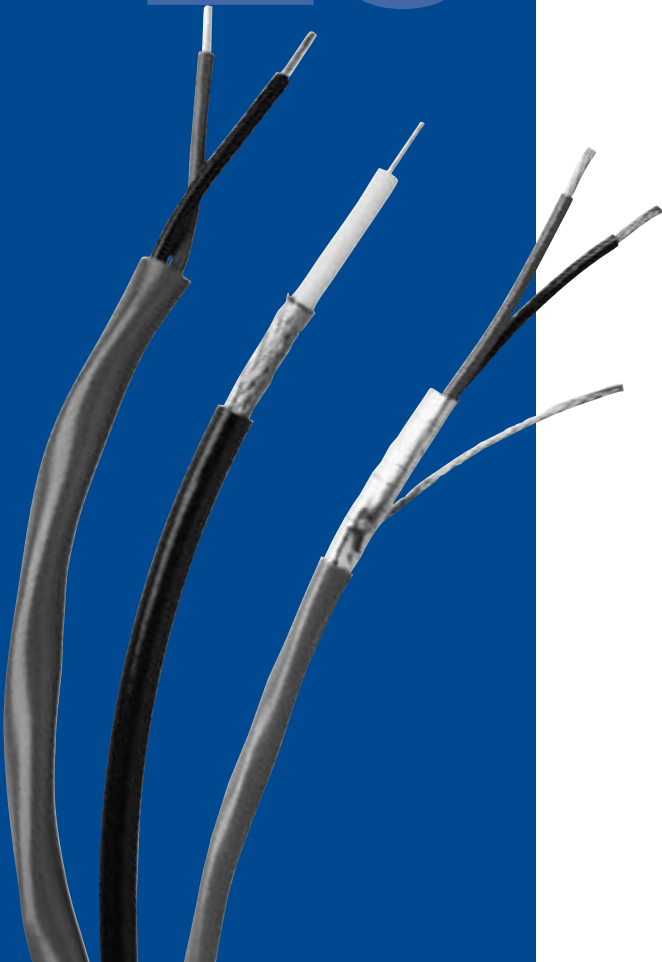

Table of Contents

New Generation Cables	Page No.
Introduction	20.2
New Generation Cable Finder Guide	20.3-20.7
Security and Alarm Cable	20.8-20.27
Multi-conductor, Unshielded: CM Rated, FT1	20.8
Multi-conductor, Unshielded: CMR Rated, FT4	20.9
Multi-conductor, Unshielded: CL3R Rated	20.11
Multi-conductor, Shielded: CMR Rated, FT4	20.12
Multi-conductor, Shielded: CL3R Rated	20.13
Multi-conductor, Water-blocked, Unshielded/Shielded: CM Rated, FT1	20.14
Twisted Pairs, Unshielded: CMR Rated, FT4	20.15
Twisted Pairs, Overall Shielded: CMR Rated, FT4	20.16
Twisted Pairs, Individually Shielded: CMR Rated, FT4	20.17
Twisted Pairs+Conductor(s), Shielded: CMR Rated, FT4	20.18
Twisted Pairs+Conductor(s), Water-blocked, Shielded: CM Rated, FT1	20.19
Plenum Multi-conductor, Unshielded: CMP Rated, FT6	20.20
Plenum Multi-conductor, Unshielded: CL2P Rated	20.22
Plenum Multi-conductor, Shielded: CMP Rated, FT6	20.23
Plenum Multi-conductor, Shielded: CL2P Rated	20.24
Plenum Twisted Pairs, Unshielded: CMP Rated, FT6	20.25
Plenum Twisted Pairs, Overall Shielded: CMP Rated, FT6	20.26
Plenum Twisted Pairs+Conductors, Shielded: CMP Rated, FT6	20.27
Communication and Control Cable	20.28-20.32
Unshielded Pairs and Multi-conductor: CM Rated	20.28
Plenum Unshielded Pairs and Multi-conductor: CMP Rated, FT6	20.29
Plenum Shielded Multi-conductor: CMP Rated, FT6	20.30
Plenum Overall Shielded Pairs: CMP Rated, FT6	20.31
Plenum Individually Shielded Twisted Pairs: CMP Rated, FT6	20.32
Thermostat and Control Cable	20.33-20.34
Access Control Banana Peel® Cable	20.35-20.36
Security and Surveillance CCTV Cable	20.37-20.41
Coax or Water-blocked Coax for CCTV: CM Rated, FT1	20.37
Composite Coax + Twisted Pair: CM or CMP (Plenum) Rated	20.38
Coax for CCTV and Card Readers: CMP Rated, FT6	20.39
UTP for CCTV and PTZ: CM or CMR Rated	20.40
Plenum UTP for CCTV and PTZ: CMP Rated, FT6	20.41
Pan/Tilt/Zoom Banana Peel Composite Cable	20.42-20.47
Security Coaxial Cable	20.48-20.50
CATV/MATV, Commercial or Schlage Systems: CM Rated, FT1	20.48
Plenum CATV or MATV Commercial Coax: CMP Rated, FT6	20.49
CCTV Limited Combustible Coax: CMP Rated, FHC 25/50	20.50
UTP CCTV Surveillance Cable	20.51-20.54
Fire Alarm Cable	20.55-20.60
Power-Limited, Unshielded Multi-conductor: FPLR Rated, FT4	20.55
Power-Limited, Shielded Multi-conductor: FPLR Rated, FT4	20.56
Power-Limited, Mid-Cap, Unshielded or Shielded: FPL Rated	20.57
Non-Power-Limited Signal, Unshielded or Shielded: NPLF Rated	20.58
Plenum Power-Limited, Unshielded or Shielded: FPLP Rated	20.59
Plenum Power-Limited, Mid-Cap, Unshielded or Shielded: FPLP	20.60
Circuit Integrity In Conduit (CIC) Safe-T-Line® Cable	20.61-20.62
Circuit Integrity (CI) Safe-T-Line Cable	20.63-20.64
Speaker Cable	20.65-20.66
Audio Cable	20.67-20.70
Shielded Multi-conductor: CMR FT4 or CL3R Rated	20.67
Plenum Unshielded Multi-conductor: CMP FT6 or CL2P Rated	20.68
Plenum Shielded Multi-conductor: CMP FT6 or CL2P Rated	20.69
Audio Cable for Nurse Call Stations	20.71-20.72

Sound, Security and Alarm Cables

Introduction



Market needs are continually challenging the limits of cable technology. And nowhere is the demand for uncompromising quality and leading-edge technology more critical than in sound and security applications.

Belden's answer to this challenge is a line of low voltage, electronic cables that provide the selection, imagination, technical expertise and quality required to meet the demands of increasingly complex sound and security systems. We call this line New Generation.

Unmatched Selection, Quality And Service

Our New Generation cable line includes one of the largest, most economical, and up-to-date selections of reliable multi-conductor and coaxial products on the market today. A full complement of cables for sound, control, computer interconnect, alarm, security, CCTV and other security applications is offered. And behind every one of these cables is years of research and development and Belden's unequalled reputation for quality and service.

Most of our New Generation cables are available from stock. Many of these are available off the shelf from distributors. If you have a new or unusual application or you cannot find a New Generation cable in this catalog section that meets your technical requirements, contact Technical Support at 1-800-BELDEN-1.

Innovative and Advanced Cables

For over 90 years, Belden has been committed to the development and support of highly effective cabling solutions. With Belden® New Generation cable products, you can be assured that you're getting the most innovative and advanced cables available today. Here are a few examples of our commitment to making our cables not only work better but also better to work with:

- Sequential footage markings on the cable jacket quickly eliminate guesswork and waste.

- The cables are predominantly NEC Riser Rated (CMR and FPLR) or above to meet even unusually stringent application conditions. All Belden CM, CMR and CMP types are both UL and C(UL) approved.
- A rip cord underneath the jacket provides for easy removal at installation.
- Easy set-up and easy-pulling, space-saving, tangle-free coil packages available for many codes. These revolutionary coil packages vastly reduce job clean-up and waste removal as well.
- Water-blocked options for multi-conductor cables and for coax — where security, surveillance and fire alarm cables are installed in intermittently wet environments.
- Our Banana Peel® Composite Cables are designed for easier and faster installation than traditional composite cables. They offer no overall jacket which eliminates the stripping of the jacket, individual cable components that are all instantly identifiable, a smaller OD, breakout versatility, prevention of short circuits caused by contact with the center conductor while stripping the outer jacket, and color-coded individual cables by application for easy identification.
- Our New Generation Safe-T-Line® Cables for Circuit Integrity meet Article 760 of the National Electrical Code for Fire-Alarm Circuit Integrity (CI) cable, the National Fire Alarm Code (NFPA 72) requirements for survivability; UL Standard 1424 — Cables for Power-limited Fire Alarm Circuits, and UL Standard 2196 — Circuit Integrity Two-hour Flame Test.

Quality You Can Count On

A system failure, or loss of continuity, can be catastrophic. That's why you need a cable that is recognized the world over for its quality. And that cable is a Belden cable. All of our New Generation cables are designed with quality as a top priority. Belden was the first major designer and manufacturer of electronic wire and cable products to earn ISO 9001:2000 registration for all its domestic and overseas facilities. In achieving total ISO 9001:2000 registration; United States' Belden passed some of

the United States' and Europe's most rigorous tests for quality and, once again, demonstrated the company's dedication to total quality.

New Generation Cable Packaging

UnReel® Dispenser

As with most Belden cables, several New Generation cable products are available in Belden's UnReel cardboard dispenser. The UnReel is a unique packaging dispensing system developed by Belden to save time and labor compared to spools, and eliminate the need for dereeling equipment. Lightweight and more economical than conventional drums or reels, UnReel dispensers have pre-punched handles for easy, individual transport as well as rectangular boxes for easy pallet delivery and storage. UnReel cable pays out smoothly and evenly with less kinking, twisting or backlashing. It also rolls out 60% faster than cable from spools or reels.

Revolutionary Coil Package

New this year, certain New Generation cables are available in a coil package. These revolutionary coils are an easy-to-handle standard package size so pallet loading is uniform. In addition, this densely packaged coil results in less space requirements for your wire, saving shelf space, truck space and cage space at the job. Plus, with no box and no spool, there is far less waste and clean-up required after the job.

Coils are the most tangle-proof package available. And, because the wire pulls from the middle you only have to pull the weight of the length of wire that is your distance from the coil. In pulling spools, you are always pulling the *whole package* weight to get it spinning. And with spools, when you stop pulling, the spool doesn't stop spinning. Help is required to stop this from happening and to keep the payouts tangle free. With coils, that help can be doing something more productive. What's more, five coils may be stacked and pulled in parallel through their common center.

So ask for New Generation's coil package, and leave reel jacks and payout stands behind along with any worries about wet boxes or discarding of empty boxes.

Sound, Security and Alarm Cables

Cable Finder Guide — By Construction

Paired and Multiconductor



AWG Size	No. of Cond. or Pairs	Stranding	Non-Shielded						Shielded					
			Non-Plenum			Plenum			Non-Plenum			Plenum		
			Part No.	Rating	Page No.	Part No.	Rating	Page No.	Part No.	Rating	Page No.	Part No.	Rating	Page No.
Paired														
18	2 PR	7	5341UE	CMR	20.15	6341UE	CMP	20.25	5341FE	CMR	20.16	—	—	—
	3 PR	7	5342UE	CMR	20.15	6342UE	CMP	20.25	5342FE	CMR	20.16	6342FE	CMP	20.26
	4 PR	7	5343UE	CMR	20.15	6343UE	CMP	20.25	5343FE	CMR	20.16	6343FE	CMP	20.26
	6 PR	7	5345UE	CMR	20.15	6345UE	CMP	20.25	5345FE	CMR	20.16	6345FE	CMP	20.26
	9 PR	7	5347UE	CMR	20.15	6347UE	CMP	20.25	—	—	—	6347FE	CMP	20.26
20	2 PR	7	—	—	—	—	—	—	5441FE	CMR	20.16	6441FE	CMP	20.26
	3 PR	7	—	—	—	—	—	—	5442FE	CMR	20.16	—	—	—
	4 PR	7	—	—	—	—	—	—	—	—	—	6443FE	CMP	20.26
	6 PR	7	—	—	—	—	—	—	5445FE	CMR	20.16	—	—	—
22	2 PR	Solid	—	—	—	6561UE	CMP	20.25	5561FE	CMR	20.16	6561FE	CMP	20.26
	2 PR	7	5541UE	CMR	20.15	6541UE	CMP	20.25	5541FE	CMR	20.16	6541FE	CMP	20.26
	3 PR	Solid	—	—	—	—	—	—	5562FE	CMR	20.16	—	—	—
	3 PR	7	5542UE	CMR	20.15	6542UE	CMP	20.25	5542FE	CMR	20.16	6542FE	CMP	20.26
	4 PR	Solid	—	—	—	—	—	—	5563FE	CMR	20.16	—	—	—
	4 PR	7	5543UE	CMR	20.15	6543UE	CMP	20.25	5543FE	CMR	20.16	6543FE	CMP	20.26
	6 PR	7	—	—	—	6545UE	CMP	20.25	5545FE	CMR	20.16	6545FE	CMP	20.26
	9 PR	7	5547UE	CMR	20.15	6547UE	CMP	20.25	—	—	—	6547FE	CMP	20.26
Shielded Twisted Pairs														
22	4 STP	7	—	—	—	—	—	—	5543PE	CMR	20.17	—	—	—
Combination Pairs + Conductors														
18	1STP +2/C	7	—	—	—	—	—	—	5302GE	CMR	20.18	—	—	—
	20	1STP +1/C	7	—	—	—	—	—	—	5401GE	CMR	20.18	6401GE	CMP
1STP +2/C		7	—	—	—	—	—	—	5402GE	CMR	20.18	—	—	—
22	1STP +1/C	7	—	—	—	—	—	—	5501GE	CMR	20.18	6501GE	CMP	20.27
	1STP +2/C	7	—	—	—	—	—	—	5502GE	CMR	20.18	6502GE	CMP	20.27
	1STP +2TP	7	—	—	—	—	—	—	5542GE	CMR	20.18	—	—	—
Water-blocked														
18	2/C	7	5300U1	CM	20.14	—	—	—	5300F1	CM	20.14	—	—	—
20	2/C	7	—	—	—	—	—	—	5400F1	CM	20.14	—	—	—
22	2/C	7	—	—	—	—	—	—	5500F1	CM	20.14	—	—	—
	1STP +1/C	Solid	—	—	—	—	—	—	5521G1	CM	20.19	—	—	—
	1STP +1/C	7	—	—	—	—	—	—	5501G1	CM	20.19	—	—	—
	1STP +2/C	Solid	—	—	—	—	—	—	5522G1	CM	20.19	—	—	—
	1STP +2/C	7	—	—	—	—	—	—	5502G1	CM	20.19	—	—	—
	1STP +4/C	7	—	—	—	—	—	—	5504G1	CM	20.19	—	—	—

STP = Shielded Twisted Pair(s) • TP = Twisted Pair(s) • PR = Pair(s) • /C = Conductor(s)

20 • New Generation® Cables

Sound, Security and Alarm Cables

Cable Finder Guide — By Application



AWG Size	No. of Cond.	Stranding	Non-Shielded						Shielded					
			Non-Plenum			Plenum			Non-Plenum			Plenum		
			Part No.	Rating	Page No.	Part No.	Rating	Page No.	Part No.	Rating	Page No.	Part No.	Rating	Page No.
Security, Alarm, Commercial Audio and Speaker														
12	2	19	5000UE	CL3R	20.11/65	6000UE	CL2P	20.22/68	5000FE	CL3R	20.13/67	6000FE	CL2P	20.24/69
	3	19	5001UE	CL3R	20.11/65	6001UE	CL2P	20.22/68	—	—	—	—	—	—
	4	19	—	—	—	6002UE	CL2P	20.22	—	—	—	—	—	—
14	2	19	5100UE	CL3R	20.11/65	6100UE	CL2P	20.22/68	5100FE	CL3R	20.13/67	6100FE	CL2P	20.24/69
	3	19	5101UE	CL3R	20.11/65	6101UE	CL2P	20.22/68	5101FE	CL3R	20.13/67	6101FE	CL2P	20.24/69
	4	19	5102UE	CL3R	20.11	6102UE	CL2P	20.22	—	—	—	—	—	—
16	2	19	5200UE	CMR	20.10/65	6200UE	CMP	20.21/68	5200FE	CMR	20.13/67	6200FE	CMP	20.24/69
	3	19	5201UE	CMR	20.10/65	6201UE	CMP	20.21/68	5201FE	CMR	20.13/67	6201FE	CMP	20.24/69
	4	19	5202UE	CMR	20.10	6202UE	CMP	20.21	5202FE	CMR	20.13	6202FE	CMP	20.24
18	2	Solid	5320UE	CMR	20.10/65	6320UE	CMP	20.21/68	5320FE	CMR	20.13/67	6320FE	CMP	20.24/69
	2	7	5300UG	CM	20.8	6300UE	CMP	20.21/68	5300FE	CMR	20.13/67	6300FE	CMP	20.24/69
	2	7	5300UE	CMR	20.10/65	—	—	—	—	—	—	—	—	—
	3	Solid	5321UE	CMR	20.10/65	6321UE	CMP	20.21/68	—	—	—	—	—	—
	3	7	5301UE	CMR	20.10/65	6301UE	CMP	20.21/68	5301FE	CMR	20.13/67	6301FE	CMP	20.24/69
	4	Solid	5322UE	CMR	20.10	6322UE	CMP	20.21	—	—	—	—	—	—
	4	7	5302UE	CMR	20.10	6302UE	CMP	20.21	5302FE	CMR	20.13	6302FE	CMP	20.24
	5	7	5303UE	CMR	20.10	6303UE	CMP	20.21	5303FE	CMR	20.13	—	—	—
	6	7	5304UE	CMR	20.10	6304UE	CMP	20.21	5304FE	CMR	20.13	6304FE	CMP	20.24
	7	7	5305UE	CMR	20.10	—	—	—	5305FE	CMR	20.13	—	—	—
	8	7	5306UE	CMR	20.10	6306UE	CMP	20.21	5306FE	CMR	20.13	6306FE	CMP	20.24
	9	7	5307UE	CMR	20.10	6307UE	CMP	20.21	5307FE	CMR	20.13	6307FE	CMP	20.24
10	7	5308UE	CMR	20.10	6308UE	CMP	20.21	—	—	—	—	—	—	
12	7	5309UE	CMR	20.10	6309UE	CMP	20.21	—	—	—	6309FE	CMP	20.24	
20	7	530BUE	CMR	20.10	—	—	—	—	—	—	—	—	—	
20	2	Solid	—	—	—	—	—	—	—	—	—	6420FE	CMP	20.23/69
	2	7	5400UE	CMR	20.9/65	6400UE	CMP	20.20/68	5400FE	CMR	20.12/67	6400FE	CMP	20.23/69
	3	Solid	—	—	—	—	—	—	5421FE	CMR	20.67	—	—	—
	3	7	5401UE	CMR	20.9/65	6401UE	CMP	20.20/68	5401FE	CMR	20.12/67	6401FE	CMP	20.23/69
	4	7	5402UE	CMR	20.9	6402UE	CMP	20.20	5402FE	CMR	20.12	6402FE	CMP	20.23
	5	7	5403UE	CMR	20.9	6403UE	CMP	20.20	5403FE	CMR	20.12	—	—	—
	7	7	5405UE	CMR	20.9	—	—	—	5405FE	CMR	20.12	6405FE	CMP	20.23
	8	7	5406UE	CMR	20.9	6406UE	CMP	20.20	—	—	—	—	—	—
	9	7	5407UE	CMR	20.9	—	—	—	5407FE	CMR	20.12	6407FE	CMP	20.23
	10	7	5408UE	CMR	20.9	—	—	—	—	—	—	—	—	—
	12	7	5409UE	CMR	20.9	—	—	—	—	—	—	—	—	—
	20	7	540BUE	CMR	20.9	—	—	—	—	—	—	—	—	—
22	2	Solid	5520UG	CM	20.8/28	—	—	—	—	—	—	—	—	—
	2	Solid	5520UE	CMR	20.9/65	6520UE	CMP	20.20/68	5520FE	CMR	20.12/67	6520FE	CMP	20.23/69
	2	7	5500UG	CM	20.8	6500UE	CMP	20.20/68	5500FE	CMR	20.12/67	6500FE	CMP	20.23/69
	2	7	5500UE	CMR	20.9/65	—	—	—	—	—	—	—	—	—
	3	Solid	—	—	—	6521UE	CMP	20.20/68	5521FE	CMR	20.12/67	6521FE	CMP	20.23/69
	3	7	5501UE	CMR	20.9/65	6501UE	CMP	20.20/68	5501FE	CMR	20.12/67	6501FE	CMP	20.23/69
	4	Solid	5582UG	CM	20.8	—	—	—	—	—	—	—	—	—
	4	Solid	5522UG	CM	20.8/28	—	—	—	—	—	—	—	—	—
	4	Solid	5522UE	CMR	20.9	6522UE	CMP	20.20	—	—	—	—	—	—
	4	Solid	5582UE	CMR	20.9	—	—	—	—	—	—	—	—	—
	4	7	5502UG	CM	20.8	6502UE	CMP	20.20	5502FE	CMR	20.12	6502FE	CMP	20.23
	4	7	5502UE	CMR	20.9	—	—	—	—	—	—	—	—	—
	5	7	5503UE	CMR	20.9	—	—	—	5503FE	CMR	20.12	—	—	—
	6	Solid	5524UE	CMR	20.9	6524UE	CMP	20.20	—	—	—	—	—	—
	6	7	5504UE	CMR	20.9	6504UE	CMP	20.20	5504FE	CMR	20.12	6504FE	CMP	20.23
	8	Solid	5526UE	CMR	20.9	—	—	—	—	—	—	—	—	—
	8	7	5506UE	CMR	20.9	6506UE	CMP	20.20	5506FE	CMR	20.12	6506FE	CMP	20.23
	10	7	5508UE	CMR	20.9	6508UE	CMP	20.20	5508FE	CMR	20.12	6508FE	CMP	20.23
12	Solid	5529UE	CMR	20.9	—	—	—	—	—	—	—	—	—	
12	7	5509UE	CMR	20.9	6509UE	CMP	20.20	—	—	—	—	—	—	

Sound, Security and Alarm Cables

Cable Finder Guide — By Application



AWG Size	No. of Cond. or Pairs	Stranding	Non-Shielded						Shielded					
			Non-Plenum			Plenum			Non-Plenum			Plenum		
			Part No.	Rating	Page No.	Part No.	Rating	Page No.	Part No.	Rating	Page No.	Part No.	Rating	Page No.
Security, Alarm, Commercial Audio and Speaker <i>(continued)</i>														
24	2/C	7	—	—	—	—	—	—	5600FE	CMR	20.12/67	—	—	—
	6/C	Solid	5624UG	CM	20.28/71	6624UG	CM	20.29/72	—	—	—	—	—	—
	8/C	Solid	5626UG	CM	20.28/71	6626UG	CM	20.29/72	—	—	—	—	—	—
	3 PR	Solid	5662UG	CM	20.28/71	6662UG	CM	20.29/72	—	—	—	—	—	—
Pro Audio Plenum, Lower Capacitance														
18	2/C	7	—	—	—	—	—	—	—	—	—	6300FC	CMP	20.30/70
	4/C	7	—	—	—	—	—	—	—	—	—	6302FC	CMP	20.30/70
	2 STP	7	—	—	—	—	—	—	—	—	—	6341PC	CMP	20.32
	3 STP	7	—	—	—	—	—	—	—	—	—	6342PC	CMP	20.32
	4 STP	7	—	—	—	—	—	—	—	—	—	6343PC	CMP	20.32
	6 STP	7	—	—	—	—	—	—	—	—	—	6345PC	CMP	20.32
20	2/C	7	—	—	—	—	—	—	—	—	—	6400FC	CMP	20.30/70
22	2/C	7	—	—	—	—	—	—	—	—	—	6500FC	CMP	20.30/70
	4/C	7	—	—	—	—	—	—	—	—	—	6502FC	CMP	20.30/70
	2 STP	7	—	—	—	—	—	—	—	—	—	6541PA	CMP	20.32
	3 STP	7	—	—	—	—	—	—	—	—	—	6542PA	CMP	20.32
	4 STP	7	—	—	—	—	—	—	—	—	—	6543PA	CMP	20.32
	6 STP	7	—	—	—	—	—	—	—	—	—	6545PA	CMP	20.32
	8 STP	7	—	—	—	—	—	—	—	—	—	6546PA	CMP	20.32
	12 STP	7	—	—	—	—	—	—	—	—	—	6548PA	CMP	20.32
	16 STP	7	—	—	—	—	—	—	—	—	—	6549PA	CMP	20.32
24	2 TP*	7	—	—	—	—	—	—	—	—	—	6641FC	CMP	20.31
High-Strand Speaker Cable														
10	2/C	65	5T00UP	CL2	20.66	6T00UP	CL2P	20.68	—	—	—	—	—	—
12	2/C	65	5000UP	CL3	20.66	—	—	—	—	—	—	—	—	—
	4/C	65	5002UP	CL3	20.66	—	—	—	—	—	—	—	—	—
14	2/C	42	5100UP	CL3	20.66	—	—	—	—	—	—	—	—	—
	4/C	42	5102UP	CL3	20.66	—	—	—	—	—	—	—	—	—
16	2/C	65	5200UP	CM	20.66	—	—	—	—	—	—	—	—	—
	4/C	65	5202UP	CM	20.66	—	—	—	—	—	—	—	—	—
18	2/C	42	5300UP	CM	20.66	—	—	—	—	—	—	—	—	—
	4/C	42	5302UP	CM	20.66	—	—	—	—	—	—	—	—	—
Fire Alarm														
12	2/C	Solid	5020UL	FPLR	20.55	6020UL	FPLP	20.59	5020FL	FPLR	20.56	6020FL	FPLP	20.59
14	2/C	Solid	5120UL	FPLR	20.55	6120UL	FPLP	20.59	5120FL	FPLR	20.56	6120FL	FPLP	20.59
	4/C	Solid	5122UL	FPLR	20.55	6122UL	FPLP	20.59	5122FL	FPLR	20.56	6122FL	FPLP	20.59
16	2/C	Solid	5220UL	FPLR	20.55	6220UL	FPLP	20.59	5220FL	FPLR	20.56	6220FL	FPLP	20.59
	4/C	Solid	5222UL	FPLR	20.55	6222UL	FPLP	20.59	5222FL	FPLR	20.56	6222FL	FPLP	20.59
18	2/C	Solid	5320UL	FPLR	20.55	6320UL	FPLP	20.59	5320FL	FPLR	20.56	6320FL	FPLP	20.59
	3/C	Solid	—	—	—	6321UL	FPLP	20.59	—	—	—	—	—	
	4/C	Solid	5322UL	FPLR	20.55	6322UL	FPLP	20.59	5322FL	FPLR	20.56	6322FL	FPLP	20.59
	6/C	Solid	5324UL	FPLR	20.55	6324UL	FPLP	20.59	—	—	—	—	—	
	8/C	Solid	5326UL	FPLR	20.55	6326UL	FPLP	20.59	—	—	—	—	—	
	10/C	Solid	5328UL	FPLR	20.55	6328UL	FPLP	20.59	—	—	—	—	—	
	12/C	Solid	5329UL	FPLR	20.55	—	—	—	—	—	—	—	—	—
22	4/C	Solid	5522UL	FPLR	20.55	6522UL	FPLP	20.59	5522FL	FPLR	20.56	—	—	—
	6/C	Solid	5524UL	FPLR	20.55	6524UL	FPLP	20.59	—	—	—	—	—	—

STP = Shielded Twisted Pair(s) • TP = Twisted Pair(s) • /C = Conductor(s)
 *Overall Shielded

20 • New Generation® Cables

Sound, Security and Alarm Cables

Cable Finder Guide — By Application



AWG Size	No. of Cond. or Pairs	Stranding	Non-Shielded						Shielded					
			Non-Plenum			Plenum			Non-Plenum			Plenum		
			Part No.	Rating	Page No.	Part No.	Rating	Page No.	Part No.	Rating	Page No.	Part No.	Rating	Page No.
Fire Alarm, Mid-Capacitance														
12	2/C	Solid	—	—	—	—	—	—	5020FJ	FPL	20.57	—	—	—
14	2/C	Solid	—	—	—	6120UJ	FPLP	20.60	5120FJ	FPL	20.57	—	—	—
16	2/C	Solid	5220UJ	FPL	20.57	6220UJ	FPLP	20.60	5220FJ	FPL	20.57	6220FK	FPLP	20.60
	4/C	Solid	—	—	—	—	—	—	5222FJ	FPL	20.57	—	—	—
18	2/C	Solid	5320UJ	FPL	20.57	6320UJ	FPLP	20.60	5320FJ	FPL	20.57	6320FK	FPLP	20.60
	4/C	Solid	—	—	—	—	—	—	5322FJ	FPL	20.57	—	—	—
Fire Alarm, Non-Power-Limited														
12	2/C	Solid	—	—	—	—	—	—	5020FN	NPLF	20.58	—	—	—
14	2/C	Solid	5120UN	NPLF	20.58	—	—	—	5120FN	NPLF	20.58	—	—	—
	4/C	Solid	—	—	—	—	—	—	5122FN	NPLF	20.58	—	—	—
16	2/C	Solid	5220UN	NPLF	20.58	—	—	—	5220FN	NPLF	20.58	—	—	—
	4/C	Solid	5222UN	NPLF	20.58	—	—	—	5222FN	NPLF	20.58	—	—	—
18	2/C	Solid	5320UN	NPLF	20.58	—	—	—	5320FN	NPLF	20.58	—	—	—
	4/C	Solid	5322UN	NPLF	20.58	—	—	—	5322FN	NPLF	20.58	—	—	—
Fire Alarm Circuit Integrity (CI)														
12	2/C	19	—	—	—	—	—	—	5000FM	FPLR-CI	20.64	—	—	—
	2/C	Solid	5020UM	FPLR-CI	20.63	—	—	—	5020FM	FPLR-CI	20.64	—	—	—
	4/C	19	—	—	—	—	—	—	5002FM	FPLR-CI	20.64	—	—	—
	4/C	Solid	5022UM	FPLR-CI	20.63	—	—	—	5022FM	FPLR-CI	20.64	—	—	—
14	2/C	19	—	—	—	—	—	—	5100FM	FPLR-CI	20.64	—	—	—
	2/C	Solid	5120UM	FPLR-CI	20.63	—	—	—	5120FM	FPLR-CI	20.64	—	—	—
	4/C	19	—	—	—	—	—	—	5102FM	FPLR-CI	20.64	—	—	—
	4/C	Solid	5122UM	FPLR-CI	20.63	—	—	—	5122FM	FPLR-CI	20.64	—	—	—
16	2/C	19	—	—	—	—	—	—	5200FM	FPLR-CI	20.64	—	—	—
	2/C	Solid	5220UM	FPLR-CI	20.63	—	—	—	5220FM	FPLR-CI	20.64	—	—	—
	4/C	19	—	—	—	—	—	—	5202FM	FPLR-CI	20.64	—	—	—
	4/C	Solid	5222UM	FPLR-CI	20.63	—	—	—	5222FM	FPLR-CI	20.64	—	—	—
18	2/C	7	—	—	—	—	—	—	5300FM	FPLR-CI	20.64	—	—	—
	2/C	Solid	5320UM	FPLR-CI	20.63	—	—	—	5320FM	FPLR-CI	20.64	—	—	—
	4/C	7	—	—	—	—	—	—	5302FM	FPLR-CI	20.64	—	—	—
	4/C	Solid	5322UM	FPLR-CI	20.63	—	—	—	5322FM	FPLR-CI	20.64	—	—	—
	6/C	7	—	—	—	—	—	—	5304FM	FPLR-CI	20.64	—	—	—
	6/C	Solid	5324UM	FPLR-CI	20.63	—	—	—	5324FM	FPLR-CI	20.64	—	—	—
	8/C	7	—	—	—	—	—	—	5306FM	FPLR-CI	20.64	—	—	—
	8/C	Solid	5326UM	FPLR-CI	20.63	—	—	—	5326FM	FPLR-CI	20.64	—	—	—
Fire Alarm Circuit Integrity in Conduit (CIC)														
12	2/C	Solid	5000UZ	FPLR-CI	20.61	—	—	—	5000FZ	FPLR-CI	20.62	—	—	—
14	2/C	7	5100UZ	FPLR-CI	20.61	—	—	—	5100FZ	FPLR-CI	20.62	—	—	—
	2/C	Solid	5120UZ	FPLR-CI	20.61	—	—	—	5120FZ	FPLR-CI	20.62	—	—	—
16	2/C	7	5200UZ	FPLR-CI	20.61	—	—	—	5200FZ	FPLR-CI	20.62	—	—	—
	2/C	Solid	5220UZ	FPLR-CI	20.61	—	—	—	5220FZ	FPLR-CI	20.62	—	—	—
	4/C	Solid	—	—	—	—	—	—	5222FZ	FPLR-CI	20.62	—	—	—
Thermostat and Control Cable														
18	1 PR	7	—	—	—	—	—	—	5340FT	CMR/CMG	20.33	6340FT	CMP	20.34
	2 PR	7	—	—	—	—	—	—	5341PT	CMR/CMG	20.33	6341PT	CMP	20.34
22	1 PR	7	—	—	—	—	—	—	5540FT	CMR/CMG	20.33	6540FT	CMP	20.34
	2 PR	7	—	—	—	—	—	—	5541PT	CMR/CMG	20.33	6541PT	CMP	20.34
24	1 PR	Solid	—	—	—	—	—	—	5660FT	CMR/CMG	20.33	6660FT	CMP	20.34
	2 PR	Solid	—	—	—	—	—	—	5661PT	CMR/CMG	20.33	6661PT	CMP	20.34

/C = Conductor(s) • PR = Pair(s) • STP = Shielded Twisted Pair(s) • TP = Twisted Pair(s)
 *Overall Shielded

Sound, Security and Alarm Cables

Cable Finder Guide — Coax and Composite



Coax Series or Component Type	AWG Size	Stranding	Non-Plenum				Plenum			
			Part No.	Rating	Shield/Braid Coverage	Page No.	Part No.	Rating	Shield/Braid Coverage	Page No.
CATV/MATV Coax										
RG-59/U	20	Solid	—	—	—	—	6439C8	CMP	Duofoil + 80% Aluminum	20.49
	20	Solid	—	—	—	—	6439Q8	CMP	Quad Shield	20.49
RG-6/U	18	Solid	5339B5	CM	Duofoil + 60% Aluminum	20.48	633938	CMP	Duofoil + 90% Aluminum	20.49
	18	Solid	5339Q5	CM	Quad Shield	20.48	6339Q8	CMP	Quad Shield	20.49
RG-11/U	14	Solid	—	—	—	—	6139B8	CMP	Duofoil + 60% Aluminum	20.49
CCTV Coax										
Mini 59	25	Solid	573945	CM	94% Bare Copper	20.37	673948	CMP	95% Bare Copper	20.39
RG-59/U	22	7	551945	CM	95% Bare Copper	20.37	—	—	—	—
	20	Solid	543945	CM	95% Bare Copper	20.37	643948	CMP	95% Bare Copper	20.39
RG-6/U	18	Solid	533945	CM	95% Bare Copper	20.37	633948	CMP	95% Bare Copper	20.39
RG-11/U	14	Solid	513945	CM	95% Bare Copper	20.37	613948	CMP	95% Bare Copper	20.39
CCTV Coax, Surveillance										
RG-59/U	20	Solid	—	—	—	—	7986LC	CMP	95% Bare Copper	20.50
RG-6/U	18	Solid	—	—	—	—	7985LC	CMP	95% Bare Copper	20.50
CATV Coax, Water-blocked										
RG-59/U	20	Solid	5439W5	CM	Duofoil® + 95% TC	20.37	—	—	—	—
RG-6/U	18	Solid	5339W5	CM	Duofoil + 60% Aluminum	20.37	—	—	—	—
Security Coax										
RG-62	22	Solid	—	—	—	—	6539Y8	CMP	95% Bare Copper	20.39
Schlage Coax										
RG-6/U	18	Solid	5399B5	CM	Duobond® + 60% Alum.	20.48	—	—	—	—
CCTV Composite Coax with Unshielded Pair for Control or Power										
Mini RG-59	25	Solid	579945	CM	95% Bare Copper	20.38	679948	CMP	95% Bare Copper	20.38
UTP	20	7	—	—	Unshielded	—	—	—	Unshielded	—
RG-59	20	Solid	549945	CM	95% Bare Copper	20.38	649948	CMP	95% Bare Copper	20.38
UTP	18	7	—	—	Unshielded	—	—	—	Unshielded	—
RG-6	18	Solid	539945	CM	95% Bare Copper	20.38	639948	CMP	95% Bare Copper	20.38
UTP	18	7	—	—	Unshielded	—	—	—	Unshielded	—
Pan/Tilt/Zoom BananaPeel Composite Coax										
RG-59/U	20	Solid	500PTZ	CMR	95% Bare Copper Braid	20.42	600PTZ	CMP	95% Bare Copper Braid	20.43
1UTP	23	Solid	—	—	Unshielded	—	—	—	Unshielded	—
2/C	18	7	—	—	Unshielded	—	—	—	Unshielded	—
RG-59/U	20	Solid	501PTZ	CMR	95% Bare Copper Braid	20.44	601PTZ	CMP	95% Bare Copper Braid	20.45
1STP	22	7	—	—	Beldfoil®	—	—	—	Beldfoil	—
2/C	18	7	—	—	Unshielded	—	—	—	Unshielded	—
RG-59/U	20	Solid	502PTZ	CMR	95% Bare Copper Braid	20.46	602PTZ	CMP	95% Bare Copper Braid	20.47
1STP	18	7	—	—	Beldfoil	—	—	—	Beldfoil	—
2/C	18	7	—	—	Unshielded	—	—	—	Unshielded	—
CCTV Surveillance UTP and Composite Cables										
2/C	16	19	5284US	CMR	Unshielded	20.51	6284US	CMP	Unshielded	20.52
2TP	24	Solid	—	—	Unshielded	—	—	—	Unshielded	—
2/C	16	19	5284UE	CMR	Unshielded	20.51	6284UE	CMP	Unshielded	20.52
2TP	23	Solid	—	—	Unshielded	—	—	—	Unshielded	—
2/C	16	19	5288US	CMR	Unshielded	20.51	6288US	CMP	Unshielded	20.52
4TP	23	Solid	—	—	Unshielded	—	—	—	Unshielded	—
4TP	24	Solid	1583A	CM	Unshielded	20.40/53	1585A	CMP	Unshielded	20.41/54
4TP	24	Solid	1500A	CM	Unshielded	20.40/53	1501A	CMP	Unshielded	20.41/54
4TP	24	Solid	1583R	CMR	Unshielded	20.40/53	—	—	—	—
2TP	24	Solid	1500R	CMR	Unshielded	20.40/53	—	—	—	—
4TP	23	Solid	7881A	CMR	Unshielded	20.40/53	7882A	CMP	Unshielded	20.41/54
Access Control BananaPeel® Composite Cables										
4/C	18	7	558AFS	CMR	Beldfoil	20.36	658AFS	CMP	Beldfoil	20.35
3TP	22	7	—	—	Beldfoil	—	—	—	Beldfoil	—
4/C	22	7	—	—	Beldfoil	—	—	—	Beldfoil	—
2/C	22	7	—	—	Beldfoil	—	—	—	Beldfoil	—
4/C	16	19	538AFS	CMR	Beldfoil	20.36	638AFS	CMP	Beldfoil	20.35
3TP	18	7	—	—	Beldfoil	—	—	—	Beldfoil	—
4/C	18	7	—	—	Beldfoil	—	—	—	Beldfoil	—
2/C	18	7	—	—	Beldfoil	—	—	—	Beldfoil	—

STP = Shielded Twisted Pair • TC = Tinned Copper • TP = Twisted Pair(s) • UTP = Unshielded Twisted Pair • /C = Conductor(s) (Multi-conductor)



For more information, contact Belden Technical Support: 1-800-BELDEN-1 • www.belden.com

20 • New Generation® Cables

Security and Alarm Cable

Residential, Light Commercial and Institutional Applications

Unshielded



Unshielded Multi-conductor

CM FT1 Rated

Product Description

Bare copper conductors, polypropylene insulation, PVC jacket. Available in Beige, Brown, Orange, Yellow, Green, Blue, Purple, Gray or White jacket colors (except as noted in footnote). Conductors may not be cabled. Sequential footage marking every two feet.

Color Code: See chart below.

Specifications

Conductor	Bare Copper
Insulation	Polypropylene
Insulation Thickness	.006" (.152mm)
Jacket	PVC
Approvals	
NEC	CM
CEC	CM FT1
NEC Articles	800
Voltage Rating	300V
Temperature Rating	75°C

Applications

- Security Systems
- Intercom/PA Systems
- Sound/Audio Systems
- Power-Limited Controls
- Single Line Telephone
- Station Wire (5582UG)

Solid Conductor



Stranded Conductor



Part No.	No. of Cond.	Stranding	Standard Lengths		Standard Unit Weight		Outer Jacket Thickness		Nominal OD	
			Ft.	m	Lbs.	kg	Inch	mm	Inch	mm

Unshielded Multi-conductor (NEC CM and CEC CM FT1)

22 AWG										
5500UG*	2	7	C-500	C-152	3.5	1.6	.015	.38	.114	2.90
			U-500	U-152	5.0	2.3				
			C-1000	C-305	7.0	3.2				
			U-1000	U-305	9.0	4.1				
5582UG**	4	solid	C-500	C-152	6.0	2.7	.015	.38	.122	3.10
			C-1000	C-305	12.0	5.4				
			U-1000	U-305	13.0	6.0				
5502UG	4	7	C-500	C-152	6.5	3.0	.015	.38	.131	3.33
			U-500 ▲	U-152	7.5	3.4				
			C-1000	C-305	13.0	6.0				
			U-1000	U-305	14.0	6.4				
5522UG† <small>new</small>	4	solid	C-500	C-152	6.0	2.7	.015	.38	.122	3.10
			C-1000	C-305	12.0	5.4				
5520UG <small>new</small>	2	solid	C-500 ♦	C-152	3.5	1.6	.015	.38	.106	2.69
			C-1000	C-305	7.0	3.2				
18 AWG										
5300UG††	2	7	C-500	C-152	7.5	3.4	.015	.38	.148	3.76
			U-500	U-152	8.5	3.9				
			U-1000	U-305	16.0	7.3				

* U-1000 available in Brown, Gray or Natural only.

** 5582UG available in Brown, Gray, White or Beige only.

† 5522UG available in White only.

†† 5300UG available in Gray, Black or Natural only.

▲ 5502UG U-500 ft. put-up available in Gray or White only.

♦ 5520UG C-500 ft. put-up available in Gray or White only.

Color Code Chart ▼

(5500UG, 5502UG, 5520UG, 5522UG, 5300UG)

Cond. No.	Color
1	Black
2	Red
3	White
4	Green

Color Code Chart

(5582UG)

Cond. No.	Color
1	Black
2	Red
3	Yellow
4	Green

▼ Except 5582UG which is Black, Red, Yellow, Green for use as station wire.

Security and Alarm Cable

Commercial Applications
Unshielded



Unshielded Multi-conductor CMR/CMG FT4 Rated

Product Description

Bare copper conductors, PVC insulation, Gray PVC jacket with rip cord. Sequential footage marking every two feet.

Color Code: See chart below.

Specifications

Conductor	Bare Copper
Insulation	PVC
Insulation Thickness	.010" (.254mm)
Jacket	PVC
Approvals	
NEC	CMR
CEC	CMG FT4
NEC Articles	800
Voltage Rating	300V
Temperature Rating	75°C

Applications

- Security Systems
- Intercom/PA Systems
- Sound/Audio Systems
- Power-Limited Controls
- Single Line Telephone

Solid Conductor



Stranded Conductor

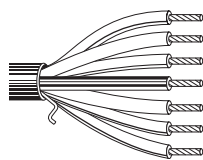

Color Code Chart ††

Cond. No.	Color	Cond. No.	Color
1	Black	11	Pink
2	Red	12	Tan
3	White	13	White/Black
4	Green	14	White/Red
5	Brown	15	White/Green
6	Blue	16	White/Orange
7	Orange	17	White/Blue
8	Yellow	18	White/Brown
9	Purple	19	White/Yellow
10	Gray	20	White/Purple

††Except 5582UE which is Black, Red, Yellow, Green for use as station wire.

Part No.	No. of Cond.	Stranding	Standard Lengths		Standard Unit Weight		Outer Jacket Thickness		Nominal OD	
			Ft.	m	Lbs.	kg	Inch	mm	Inch	mm

Unshielded Multi-conductor (NEC CMR and CEC CMG FT4)

22 AWG										
5520UE	2	solid	C-500 U-500 C-1000 U-1000 1000	C-152 U-152 C-305 U-305 305	4.0 5.5 8.0 9.0 9.0	1.8 2.5 3.6 4.1 4.1	.015	.38	.122	3.10
5500UE	2	7	C-500 U-500 500 C-1000 U-1000 1000	C-152 U-152 152 C-305 U-305 305	4.0 5.5 5.5 8.0 10.0 9.0	1.8 2.5 2.5 3.6 4.5 4.1	.015	.38	.128	3.25
5501UE	3	7	U-1000 1000	U-305 305	13.0 13.0	5.9 5.9	.015	.38	.135	3.43
5522UE	4	solid	U-1000 1000	U-305 305	16.0 16.0	7.3 7.3	.015	.38	.141	3.58
5582UE*	4	solid	C-500 U-500 U-1000 1000	C-152 U-152 U-305 305	7.0 6.5 12.0 12.0	3.2 3.0 5.5 5.5	.015	.38	.141	3.58
5502UE**	4	7	C-500 U-500 U-1000 1000	C-152 U-152 U-305 305	7.5 9.0 16.0 16.0	3.4 4.1 7.3 7.3	.015	.38	.148	3.76
5503UE	5	7	U-1000 1000	U-305 305	20.0 20.0	9.1 9.1	.015	.38	.162	4.11
5524UE	6	solid	C-500 1000	C-152 305	10.5 22.0	4.8 10.0	.015	.38	.168	4.27
5504UE**	6	7	C-500 U-500 500 U-1000 1000	C-152 U-152 152 U-305 305	12.5 14.0 13.5 27.0 27.0	5.7 6.4 6.1 12.3 12.3	.015	.38	.177	4.50
5526UE	8	solid	1000	305	28.0	12.7	.015	.38	.182	4.62
5506UE	8	7	U-1000 1000	U-305 305	29.0 30.0	13.2 13.6	.015	.38	.192	4.88
5508UE	10	7	U-1000 1000	U-305 305	36.0 41.0	16.3 18.6	.015	.38	.226	5.74
5529UE	12	solid	U-1000 1000	U-305 305	40.0 42.0	18.1 19.1	.015	.38	.221	5.61
5509UE	12	7	U-500 U-1000 1000	U-152 U-305 305	21.5 42.0 47.0	9.8 19.1 21.4	.015	.38	.233	5.92
20 AWG										
5400UE	2	7	C-500 U-1000 1000	C-152 U-305 305	6.0 13.0 13.0	2.7 5.9 5.9	.015	.38	.142	3.61
5401UE	3	7	500 U-1000 1000	152 U-305 305	9.0 18.0 18.0	4.1 8.2 8.2	.015	.38	.150	3.81
5402UE	4	7	C-500 U-1000 1000	C-152 U-305 305	10.5 23.0 23.0	4.8 10.5 10.5	.015	.38	.165	4.19
5403UE	5	7	U-1000 1000	U-305 305	27.0 28.0	12.2 12.7	.015	.38	.181	4.60
5405UE	7	7	500 1000	152 305	19.0 40.0	8.6 18.2	.015	.38	.198	5.03
5406UE	8	7	U-1000 1000	U-305 305	41.0 43.0	18.6 19.5	.015	.38	.215	5.46
5407UE	9	7	1000	305	48.0	21.8	.015	.38	.233	5.92
5408UE	10	7	1000	305	53.0	24.1	.015	.38	.254	6.45
5409UE	12	7	1000	305	62.0	28.1	.015	.38	.262	6.65
540BUE	20	7	1000	305	110.0	49.9	.025	.64	.347	8.81

* 5582UE also available in Beige, Brown or White.

** 5502UE and 5504UE also available in White.



Security and Alarm Cable

Commercial Applications

Unshielded



Unshielded Multi-conductor (cont'd.)

CMR/CMG FT4 Rated

Product Description

Bare copper conductors, PVC insulation, Gray PVC jacket with rip cord. Sequential footage marking every two feet.

Color Code: See chart below.

Specifications

Conductor	Bare Copper
Insulation	PVC
Insulation Thickness	.010" (.254mm)
Jacket	PVC
Approvals	
NEC	CMR
CEC	CMG FT4
NEC Articles	800
Voltage Rating	300V
Temperature Rating	75°C

Applications

- Addressable Fire Systems
- Data Circuits
- Monitor/Detection
- Control Circuits
- Initiating Circuits
- Notification Circuits

Solid Conductor



Stranded Conductor

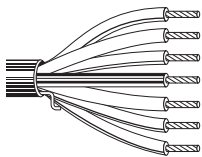

Color Code Chart

Cond. No.	Color	Cond. No.	Color
1	Black	11	Pink
2	Red	12	Tan
3	White	13	White/Black
4	Green	14	White/Red
5	Brown	15	White/Green
6	Blue	16	White/Orange
7	Orange	17	White/Blue
8	Yellow	18	White/Brown
9	Purple	19	White/Yellow
10	Gray	20	White/Purple

Part No.	No. of Cond.	Stranding	Standard Lengths		Standard Unit Weight		Outer Jacket Thickness		Nominal OD	
			Ft.	m	Lbs.	kg	Inch	mm	Inch	mm

Unshielded Multi-conductor (NEC CMR and CEC CMG FT4)

18 AWG										
5320UE	2	solid	C-500 U-1000	C-152 U-305	7.5 17.0	3.4 7.7	.015	.38	.151	3.84
5300UE*	2	7	C-500 U-500 500 U-1000 1000	C-152 U-152 152 U-305 305	8.5 9.5 9.5 17.0 18.0	3.9 4.3 4.3 7.7 8.2	.015	.38	.161	4.09
5321UE	3	solid	U-1000 1000	U-305 305	23.0 23.0	10.4 10.4	.015	.38	.160	4.06
5301UE	3	7	500 U-1000 1000	152 U-305 305	12.5 25.0 25.0	5.7 11.3 11.3	.015	.38	.171	4.34
5322UE	4	solid	1000	305	30.0	13.6	.015	.38	.176	4.47
5302UE	4	7	C-250 U-500 500 U-1000 1000	C-76.2 U-152 152 U-305 305	7.5 16.5 16.0 32.0 32.0	3.4 7.5 7.3 14.5 14.5	.015	.38	.188	4.78
5303UE	5	7	500 U-1000 1000	152 U-305 305	20.5 39.0 39.0	9.3 17.7 17.7	.015	.38	.207	5.26
5304UE	6	7	500 U-1000 1000	152 U-305 305	26.0 51.0 52.0	11.8 23.2 23.6	.015	.38	.226	5.74
5305UE	7	7	U-1000 1000	U-305 305	51.0 52.0	23.2 23.6	.015	.38	.226	5.74
5306UE	8	7	500 1000	152 305	30.0 59.0	13.6 26.8	.015	.38	.248	6.30
5307UE	9	7	1000	305	66.0	30.0	.015	.38	.269	6.83
5308UE	10	7	500 1000	152 305	38.5 74.0	17.5 33.6	.015	.38	.294	7.47
5309UE	12	7	500 1000	152 305	47.5 90.0	21.6 40.9	.020	.51	.314	7.98
530BUE	20	7	1000	305	152.0	69.0	.025	.64	.400	10.16
16 AWG										
5200UE	2	19	C-500 U-500 500 U-1000 1000	C-152 U-152 152 U-305 305	11.5 13.0 12.5 24.0 25.0	5.2 5.9 5.7 10.9 11.4	.015	.38	.184	4.67
5201UE	3	19	U-500 500 U-1000 1000	U-152 152 U-305 305	18.5 18.0 35.0 38.0	8.4 8.2 15.9 17.3	.015	.38	.196	4.98
5202UE	4	19	U-500 500 U-1000 1000	U-152 152 U-305 305	23.5 23.0 45.0 47.0	10.7 10.4 20.4 21.3	.015	.38	.216	5.49
5205UE	7	19	1000	305	77.0	35.0	.015	.38	.261	6.63

*5300UE also available in White or Black.

Security and Alarm Cable

Commercial Applications
Unshielded



Unshielded Multi-conductor CMR/CL3R Rated

Product Description

Bare copper conductors, PVC insulation, Gray PVC jacket with rip cord. Sequential footage marking every two feet.

Color Code: See chart below.

Specifications

Conductor	Bare Copper
Insulation	PVC
Insulation Thickness	.014" (.356mm)
Jacket	PVC
Approvals	NEC CMR FPLR† & CL3R
NEC Articles	725 & 760
Voltage Rating	300V
Temperature Rating	75°C

†CMR FPLR dual rating for 5000UE, 5100UE, 5000FE and 5100FE only.

Applications

- Security Systems
- Intercom/PA Systems
- Sound/Audio Systems
- Power-Limited Controls
- Single Line Telephone
- Fire Alarm Systems (Red Only) Dual Rated**

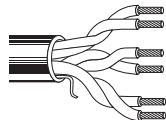

Part No.	No. of Cond.	Stranding	Standard Lengths		Standard Unit Weight		Outer Jacket Thickness		Nominal OD	
			Ft.	m	Lbs.	kg	Inch	mm	Inch	mm

Unshielded Multi-conductor (NEC CMR FPLR CL3R)

14 AWG										
5100UE*	2	19	500	152	20.0	9.1	.015	.38	.234	5.94
			U-1000	U-305	38.0	17.2				
			1000	305	40.0	18.2				
5101UE	3	19	1000	305	56.0	25.5	.015	.38	.249	6.32
5102UE	4	19	500	152	38.5	17.5	.015	.38	.276	7.01
			1000	305	71.0	33.2				
12 AWG										
5000UE*	2	19	500	152	29.0	13.2	.015	.38	.268	6.81
			1000	305	57.0	25.9				
5001UE	3	19	1000	305	82.0	37.3	.015	.38	.286	7.26

*5100UE and 5000UE also available in Red for Fire Alarm (FPLR).

Color Code Chart

Cond. No.	Color
1	Black
2	White
3	Red
4	Green



Security and Alarm Cable

Commercial Applications
Shielded



Shielded Multi-conductor CMR/CMG FT4 Rated

Product Description

Bare copper conductors, PVC insulation, cabled, Beldfoil® shield tape (foil side out) with drain wire, Gray PVC jacket with rip cord. Sequential footage marking every two feet.

Color Code: See chart below.

Specifications

Conductor	Bare Copper
Insulation	PVC
Insulation Thickness	.010" (.254mm)
Shield	Beldfoil
Jacket	PVC
Approvals	
NEC	CMR
CEC	CMG FT4
NEC Articles	800
Voltage Rating	300V
Temperature Rating	75°C

Applications

- Security Systems
- Intercom/PA Systems
- Sound/Audio Systems
- Power-Limited Controls

Solid Conductor

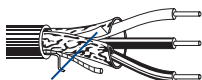

Shorting Fold

Stranded Conductor

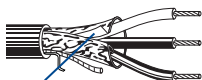

Shorting Fold

Color Code Chart

Cond. No.	Color
1	Black
2	Red
3	White
4	Green
5	Brown
6	Blue
7	Orange
8	Yellow
9	Purple
10	Gray

Part No.	No. of Cond.	Stranding	Standard Lengths		Standard Unit Weight		Outer Jacket Thickness		Nominal OD	
			Ft.	m	Lbs.	kg	Inch	mm	Inch	mm

Shielded Multi-conductor (NEC CMR and CEC CMG FT4)

24 AWG										
5600FE	2	7	U-1000 1000	U-305 305	11.0 10.0	5.0 4.5	.015	.38	.120	3.05
22 AWG										
5520FE	2	solid	C-500 C-1000 U-1000 1000	C-152 C-305 U-305 305	6.5 13.0 14.0 14.0	3.0 5.9 6.4 6.4	.015	.38	.125	3.18
5500FE	2	7	C-500 U-500 500 U-1000 1000	C-152 U-152 152 U-305 305	5.5 6.5 6.5 12.0 12.0	2.5 3.0 3.0 5.4 5.4	.015	.38	.130	3.30
5521FE	3	solid	U-1000 1000	U-305 305	12.0 12.0	5.4 5.4	.015	.38	.132	3.35
5501FE	3	7	C-500 U-500 500 U-1000 1000	C-152 U-152 152 U-305 305	7.0 8.0 7.5 15.0 15.0	3.2 3.6 3.4 6.8 6.8	.015	.38	.138	3.51
5502FE	4	7	C-500 U-500 500 U-1000 1000	C-152 U-152 152 U-305 305	8.5 9.5 9.5 18.0 18.0	3.9 4.3 4.3 8.2 8.2	.015	.38	.152	3.86
5503FE	5	7	1000	305	22.0	10.0	.015	.38	.165	4.19
5504FE	6	7	C-500 U-500 U-1000 1000	C-152 U-152 U-305 305	13.5 15.0 29.0 29.0	6.1 6.8 13.2 13.2	.015	.38	.179	4.55
5506FE	8	7	U-500 U-1000 1000	U-152 U-305 305	16.5 32.0 32.0	7.5 14.5 14.5	.015	.38	.196	4.98
5508FE	10	7	U-500 U-1000 1000	U-152 U-305 305	19.5 38.0 44.0	8.9 17.2 20.0	.015	.38	.230	5.84
20 AWG										
5400FE	2	7	C-500 U-500 500 U-1000 1000	C-152 U-152 152 U-305 305	8.0 9.0 8.5 17.0 17.0	3.6 4.1 3.9 7.2 7.2	.015	.38	.145	3.68
5401FE	3	7	U-500 500 U-1000 1000	U-152 152 U-305 305	11.0 10.5 21.0 21.0	5.0 4.8 9.5 9.5	.015	.38	.153	3.89
5402FE	4	7	C-500 U-500 500 U-1000 1000	C-152 U-152 152 U-305 305	12.0 12.5 13.0 25.0 26.0	5.4 5.7 5.9 11.3 11.8	.015	.38	.168	4.27
5403FE	5	7	U-1000 1000	U-305 305	30.0 30.0	13.6 13.6	.015	.38	.184	4.67
5405FE	7	7	U-1000 1000	U-305 305	39.0 40.0	17.7 18.2	.015	.38	.201	5.11
5407FE	9	7	1000	305	51.0	23.2	.015	.38	.236	5.99

Security and Alarm Cable

Commercial Applications

Shielded



Shielded Multi-conductor (cont'd.)
 CMR/CMG FT4 Rated or CL3R Rated

Product Description

Bare copper conductors, PVC insulation, cabled, Beldfoil® shield tape (foil side out) with drain wire, Gray PVC jacket with rip cord. Sequential footage marking every two feet.

Color Code: See chart below.

Specifications

Conductor	Bare Copper
Insulation	PVC
Insulation Thickness	
18 to 16 AWG	.010" (.254mm)
14 to 12 AWG	.014" (.356mm)
Shield	Beldfoil
Jacket	PVC
Approvals	
NEC (18 to 16 AWG)	CMR FPLR†
CEC (18 to 16 AWG)	CMG FT4
NEC (14 to 12 AWG)	CL3R
NEC Articles	
18 to 16 AWG	800
14 to 12 AWG	725
Voltage Rating	300V
Temperature Rating	75°C

†CMR FPLR dual rating for 5000UE, 5100UE, 5000FE and 5100FE only.

Applications

- Security Systems
- Intercom/PA Systems
- Sound/Audio Systems
- Power-Limited Controls
- Fire Alarm Systems (Red Only) Dual Rated†

Solid Conductor

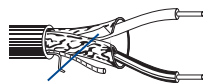

Shorting Fold

Stranded Conductor

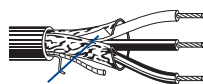

Shorting Fold

Color Code Chart (18 to 16 AWG)

Cond. No.	Color	Cond. No.	Color
1	Black	6	Blue
2	Red	7	Orange
3	White	8	Yellow
4	Green	9	Purple
5	Brown	10	Gray

Part No.	No. of Cond.	Stranding	Standard Lengths		Standard Unit Weight		Outer Jacket Thickness		Nominal OD	
			Ft.	m	Lbs.	kg	Inch	mm	Inch	mm

Shielded Multi-conductor (NEC CMR and CEC CMG FT4)

18 AWG										
5320FE	2	solid	C-500	C-152	10.0	4.6	.015	.38	.155	3.94
			U-1000	U-305	21.0	9.5				
			1000	305	21.0	9.5				
5300FE	2	7	C-500	C-152	11.0	5.0	.015	.38	.165	4.19
			U-500	U-152	12.0	5.5				
			500	152	12.0	5.5				
			U-1000	U-305	23.0	10.4				
1000	305	23.0	10.4							
5301FE	3	7	U-500	U-152	15.5	7.0	.015	.38	.175	4.45
			500	152	15.0	6.8				
			U-1000	U-305	30.0	13.6				
1000	305	30.0	13.6							
5302FE	4	7	C-250	C-76	8.8	4.0	.015	.38	.192	4.88
			U-500	U-152	19.0	8.6				
			500	152	20.5	9.3				
			U-1000	U-305	36.0	16.3				
1000	305	37.0	16.8							
5303FE	5	7	U-500	U-152	22.5	10.2	.015	.38	.211	5.36
			500	152	22.5	10.2				
			U-1000	U-305	43.0	19.5				
1000	305	45.0	20.5							
5304FE	6	7	U-500	U-152	28.5	12.9	.015	.38	.230	5.84
			500	152	26.0	11.8				
			1000	305	57.0	25.9				
5305FE	7	7	1000	305	57.0	25.9	.015	.38	.230	5.84
5306FE*	8	7	500	152	32.0	14.5	.015	.38	.270	6.86
			1000	305	64.0	29.1				
5307FE	9	7	1000	305	71.0	32.3	.015	.38	.272	6.91
16 AWG										
5200FE**	2	19	U-500	U-152	16.5	7.5	.015	.38	.188	4.78
			500	152	16.5	7.5				
			U-1000	U-305	31.0	14.1				
1000	305	32.0	14.5							
5201FE	3	19	500	152	21.5	9.8	.015	.38	.200	5.08
			U-1000	U-305	42.0	19.1				
			1000	305	42.0	19.1				
5202FE	4	19	500	152	26.5	12.0	.015	.38	.220	5.59
			1000	305	54.0	24.5				

Shielded Multi-conductor (NEC CL3R)

14 AWG										
5100FE†	2	19	500	152	28.5	12.9	.015	.38	.238	6.05
			U-1000	U-305	49.0	22.2				
			1000	305	51.0	23.2				
5101FE	3	19	1000	305	66.0	30.0	.015	.38	.253	6.43
12 AWG										
5000FE†	2	19	500	152	36.5	16.6	.015	.38	.272	6.91
			1000	305	67.0	30.5				

* 5306FE also available in Natural.

** 5200FE also available in White.

† 5100FE and 5000FE available in Red or Gray for Fire Alarm (FPLR).

(14 to 12 AWG)

Cond. No.	Color
1	Black
2	White
3	Red

Security and Alarm Cable

Water-Blocked for Use in Underground Ducts
Unshielded and Shielded



Water-blocked, Unshielded Multi-conductor CM FT1 Rated

Product Description

Tinned copper conductors, PVC insulation, cabled with overall water-blocking tape, Gray PVC jacket with rip cord. Sequential footage marking every two feet.

Water-blocked, Shielded Multi-conductor CM FT1 Rated

Product Description

Tinned copper conductors, PVC insulation, cabled with overall Beldfoil® shield and drain wire, overall water-blocking tape, Gray PVC jacket with rip cord. Sequential footage marking every two feet.

Color Code: Black, Red.

Specifications

Conductor	Tinned Copper
Insulation	PVC
Insulation Thickness	.010" (.254mm)
Shield (where applicable)	Beldfoil
Jacket	PVC
Approvals	
NEC	CM
CEC	CM FT1
NEC Articles	800
Voltage Rating	300V
Temperature Rating	105°C

Applications

- Security Systems
- Intercom/PA Systems
- Sound/Audio Systems
- Power-Limited Controls
- Indoor or Outdoor Use

Unshielded Water-blocked



Shielded and Water-blocked

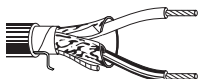

Part No.	No. of Cond.	Stranding	Standard Lengths		Standard Unit Weight		Outer Jacket Thickness		Nominal OD	
			Ft.	m	Lbs.	kg	Inch	mm	Inch	mm

Water-blocked, Unshielded Multi-conductor (NEC CM and CEC CM FT1)

18 AWG										
5300U1	2	7	U-500	U-152	12.0	5.5	.025	.64	.207	5.26
			500	152	13.5	6.1				
			U-1000	U-305	22.0	10.0				
			1000	305	24.0	10.9				

Water-blocked, Shielded Multi-conductor (NEC CM and CEC CM FT1)

22 AWG										
5500F1	2	7	U-500	U-152	9.0	4.1	.025	.64	.192	4.88
			500	152	9.0	4.1				
			U-1000	U-305	16.0	7.3				
			1000	305	17.0	7.7				

20 AWG										
5400F1	2	7	U-500	U-152	11.5	5.2	.025	.64	.206	5.23
			500	152	11.0	5.0				
			U-1000	U-305	21.0	9.5				
			1000	305	21.0	9.5				

18 AWG										
5300F1	2	7	U-500	U-152	15.0	6.8	.025	.64	.222	5.64
			500	152	15.0	6.8				
			U-1000	U-305	29.0	13.2				
			1000	305	30.0	13.6				

Security and Alarm Cable

Commercial Applications
Unshielded



Unshielded Twisted Pairs

CMR/CMG FT4 Rated

Product Description

Bare copper conductors, PVC insulation. Conductors twisted into pairs, multiple pairs cabled together, Gray PVC jacket with rip cord. Sequential footage marking every two feet.

Color Code: See chart below.

Specifications

Conductor	Bare Copper
Insulation	PVC
Insulation Thickness	.010" (.254mm)
Jacket	PVC
Approvals	
NEC	CMR
CEC	CMG FT4
NEC Articles	800
Voltage Rating	300V
Temperature Rating	75°C

Applications

- Security Systems
- Intercom/PA Systems
- Sound/Audio Systems
- Power-Limited Controls

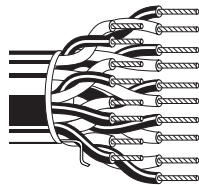

Color Code Chart

Pair No.	Color Combination
1	Black & Red
2	Black & White
3	Black & Green
4	Black & Blue
5	Black & Yellow
6	Black & Brown
7	Black & Orange
8	Red & White
9	Red & Green

Part No.	No. of Pairs	Stranding	Standard Lengths		Standard Unit Weight		Outer Jacket Thickness		Nominal OD	
			Ft.	m	Lbs.	kg	Inch	mm	Inch	mm

Unshielded Twisted Pairs (NEC CMR and CEC CMG FT4)

22 AWG										
5541UE	2	7	U-1000 1000	U-305 305	18.0 19.0	8.2 8.6	.015	.38	.206	5.23
5542UE	3	7	U-500 U-1000 1000	U-152 U-305 305	13.0 24.0 26.0	5.9 10.9 11.8	.015	.38	.220	5.59
5543UE	4	7	U-1000 1000	U-305 305	31.0 32.0	14.1 14.5	.015	.38	.243	6.17
5547UE	9	7	1000	305	70.0	31.8	.020	.51	.334	8.48
18 AWG										
5341UE	2	7	U-1000 1000	U-305 305	34.0 36.0	15.4 16.4	.015	.38	.266	6.76
5342UE	3	7	U-1000 1000	U-305 305	48.0 50.0	21.8 22.7	.015	.38	.283	7.19
5343UE	4	7	1000	305	67.0	30.5	.018	.46	.320	8.13
5345UE	6	7	1000	305	96.0	43.6	.018	.46	.362	9.19
5347UE	9	7	1000	305	140.0	63.6	.020	.51	.434	11.02

Security and Alarm Cable

Commercial Applications
Shielded



Overall Shielded Twisted Pairs CMR/CMG FT4 Rated

Product Description

Bare copper conductors, PVC insulation. Conductors twisted into pairs, multiple pairs cabled together, overall Beldfoil® shield (foil side out) and drain wire, overall Gray PVC jacket with rip cord. Sequential footage marking every two feet.

Color Code: See chart below.

Specifications

Conductor	Bare Copper
Insulation	PVC
Insulation Thickness	.010" (.254mm)
Shield	Beldfoil
Jacket	PVC
Approvals	
NEC	CMR
CEC	CMG FT4
NEC Articles	800
Voltage Rating	300V
Temperature Rating	75°C

Applications

- Security Systems
- Intercom/PA Systems
- Sound/Audio Systems
- Power-Limited Controls

Solid Conductor

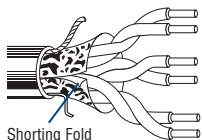

Stranded Conductor

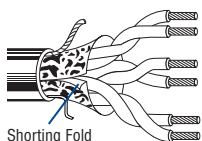

Color Code Chart

Pair No.	Color Combination	Pair No.	Color Combination
1	Black & Red	4	Black & Blue
2	Black & White	5	Black & Yellow
3	Black & Green	6	Black & Brown

Part No.	No. of Pairs	Stranding	Standard Lengths		Standard Unit Weight		Outer Jacket Thickness		Nominal OD	
			Ft.	m	Lbs.	kg	Inch	mm	Inch	mm

Overall Shielded Twisted Pairs (NEC CMR and CEC CMG FT4)

22 AWG										
5561FE	2	solid	U-1000 1000	U-305 305	21.0 22.0	9.5 10.0	.015	.38	.200	5.08
5541FE	2	7	U-500 U-1000 1000	U-152 U-305 305	11.5 21.0 23.0	5.2 9.5 10.4	.015	.38	.209	5.31
5562FE	3	solid	U-1000 1000	U-305 305	26.0 28.0	11.8 12.7	.015	.38	.212	5.38
5542FE	3	7	U-1000 1000	U-305 305	27.0 29.0	12.3 13.2	.015	.38	.223	5.66
5563FE	4	solid	U-1000	U-305	33.0	15.0	.015	.38	.246	6.25
5543FE	4	7	1000	305	34.0	15.4	.015	.38	.246	6.25
5545FE	6	7	U-1000 1000	U-305 305	46.0 48.0	20.9 21.8	.015	.38	.278	7.06
20 AWG										
5441FE	2	7	500 U-1000 1000	152 U-305 305	15.0 29.0 30.0	6.8 13.2 13.2	.015	.38	.235	5.97
5442FE	3	7	U-1000 1000	U-305 305	38.0 38.0	17.2 17.2	.015	.38	.252	6.40
5445FE	6	7	1000	305	72.0	32.7	.020	.51	.323	8.20
18 AWG										
5341FE	2	7	500 U-1000 1000	152 U-305 305	21.0 40.0 42.0	9.5 18.1 19.1	.015	.38	.270	6.86
5342FE	3	7	1000	305	52.0	23.6	.015	.38	.275	6.99
5343FE	4	7	1000	305	70.0	31.8	.015	.38	.318	8.08
5345FE	6	7	500 1000	152 305	52.5 103.0	23.9 46.8	.020	.51	.373	9.47

Security and Alarm Cable

Commercial Applications
Shielded



Individually Shielded Twisted Pairs

CMR/CMG FT4 Rated

Product Description

Bare copper conductors, PVC insulation. Conductors twisted into pairs and individually shielded with Beldfoil® tape (aluminum side facing in) and a drain wire, multiple pairs cabled together, Gray PVC jacket with rip cord. Sequential footage marking every two feet.

Color Code: See chart below.

Specifications

Conductor	Bare Copper
Insulation	PVC
Insulation Thickness	.010" (.254mm)
Shield	Beldfoil
Jacket	PVC
Approvals	
NEC	CMR
CEC	CMG FT4
NEC Articles	800
Voltage Rating	300V
Temperature Rating	75°C

Applications

- Security Systems
- Intercom/PA Systems
- Sound/Audio Systems
- Power-Limited Controls

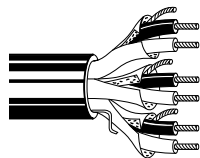

Part No.	No. of Pairs	Stranding	Standard Lengths		Standard Unit Weight		Outer Jacket Thickness		Nominal OD	
			Ft.	m	Lbs.	kg	Inch	mm	Inch	mm

Individually Shielded Twisted Pairs (NEC CMR and CEC CMG FT4)

22 AWG										
5543PE	4	7	1000	305	55.0	25.0	.033	.84	.303	7.70

Color Code Chart

Pair No.	Color Combination
1	Black/Red & Red
2	Black/White & White
3	Black/Green & Green
4	Black/Blue & Blue

Security and Alarm Cable

Commercial Applications

Shielded



Shielded

Twisted Pair plus Conductor(s)

CMR/CMG FT4 Rated

Product Description

Bare copper conductors, PVC insulation, Black/Red pair shielded with Beldfoil® tape (aluminum side facing in) and tinned copper drain wire, cabled with additional insulated conductor(s) as indicated, Gray PVC jacket with rip cord. Sequential footage marking every two feet.

Color Code: Black & Red (shielded pair), White, Green. (5542GE Black & Red, Black & White, Black & Green pairs).

Specifications

Conductor	Bare Copper
Insulation	PVC
Insulation Thickness	.010" (.254mm)
Shield	Beldfoil
Jacket	PVC
Approvals	
NEC	CMR
CEC	CMG FT4
NEC Articles	800
Voltage Rating	300V
Temperature Rating	75°C

Applications

- Security Systems
- Intercom/PA Systems
- Sound/Audio Systems
- Power-Limited Controls

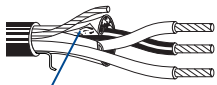

Shorting Fold

Part No.	No. of Pairs + No. of Cond.	Stranding	Standard Lengths		Standard Unit Weight		Outer Jacket Thickness		Nominal OD	
			Ft.	m	Lbs.	kg	Inch	mm	Inch	mm

STP plus Conductor(s) (NEC CMR and CEC CMG FT4)

22 AWG										
5501GE	1 STP +1/C	7	U-1000	U-305	16.0	7.3	.015	.38	.171	4.34
5502GE	1 STP +2/C	7	U-500 U-1000 1000	U-152 U-305 305	10.0 19.0 19.0	4.5 8.6 8.6	.015	.38	.186	4.72
5542GE	1 STP +2TP	7	U-1000	U-305	26.0	11.8	.015	.38	.220	5.59
20 AWG										
5401GE	1 STP +1/C	7	1000	305	23.0	10.4	.015	.38	.196	4.98
5402GE	1 STP +2/C	7	U-1000	U-305	26.0	11.8	.015	.38	.200	5.08
18 AWG										
5302GE	1 STP +2/C	7	U-1000	U-305	38.0	17.2	.015	.38	.225	5.72

STP = Shielded Twisted Pair(s) • /C = Conductor(s)

Security and Alarm Cable

Water-Blocked for Use in Underground Ducts



Water-blocked, Shielded Twisted Pair plus Conductor(s)

CM FT1 Rated

Product Description

Tinned copper conductors, PVC insulation, Black/Red conductors twisted into a pair and shielded with Beldfoil® tape (aluminum side facing in) and drain wire, cabled with additional insulated conductor(s) as indicated, water-blocking tape overall, Gray PVC jacket with rip cord. Sequential footage marking every two feet.

Color Code: Black & Red (shielded pair); White, Green, Brown, Blue.

Specifications

Conductor	Tinned Copper
Insulation	PVC
Insulation Thickness	.010" (.254mm)
Shield	
Twisted Pair	Beldfoil
Overall	Water-blocking Tape
Jacket	PVC
Approvals	
NEC	CM
CEC	CM FT1
NEC Articles	800
Voltage Rating	300V
Temperature Rating	105°C

Applications

- Security Systems
- Intercom/PA Systems
- Sound/Audio Systems
- Power-Limited Controls
- Indoor or Outdoor Use

Solid Conductor

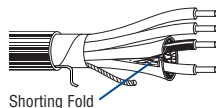

Stranded Conductor

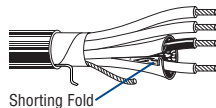

Part No.	No. of Pairs + No. of Cond.	Stranding	Standard Lengths		Standard Unit Weight		Outer Jacket Thickness		Nominal OD	
			Ft.	m	Lbs.	kg	Inch	mm	Inch	mm
Water-blocked, STP plus Conductor(s) (NEC CM and CEC CM FT1)										
22 AWG										
5521G1	1 STP +1/C	solid	U-500	U-152	12.0	5.4	.025	.64	.212	5.38
			500	152	13.0	5.9				
			U-1000	U-305	22.0	10.0				
			1000	305	22.0	10.0				
5501G1	1 STP +1/C	7	U-500	U-152	12.0	5.4	.025	.64	.222	5.64
			500	152	12.0	5.4				
			U-1000	U-305	23.0	10.4				
			1000	305	25.0	11.4				
5522G1	1 STP +2/C	solid	U-500	U-152	13.0	6.0	.025	.64	.224	5.69
			500	152	15.0	6.8				
			U-1000	U-305	25.0	11.3				
			1000	305	27.0	12.3				
5502G1	1 STP +2/C	7	U-500	U-152	14.0	6.4	.025	.64	.240	6.10
			500	152	14.0	6.4				
			U-1000	U-305	27.0	12.3				
			1000	305	29.0	13.2				
5504G1	1 STP +4/C	7	U-500	U-152	18.0	8.2	.025	.64	.240	6.10
			500	152	18.5	8.4				
			U-1000	U-305	35.0	15.9				
			1000	305	37.0	16.8				

STP = Shielded Twisted Pair(s) • /C = Conductor(s)

Security and Alarm Cable

Commercial Applications
Unshielded, Plenum-Rated



Unshielded Multi-conductor

CMP FT6 Rated

Product Description

Bare copper conductors, Flamarrest® insulation, conductors cabled, Natural Flamarrest jacket, rip cord. Sequential footage marking every two feet.

Color Code: See chart below.

Specifications

Conductor	Bare Copper
Insulation	Flamarrest
Insulation Thickness	.009" (.229mm)
Jacket	Flamarrest
Approvals	NEC CMP CEC CMP FT6
NEC Articles	800
Voltage Rating	300V
Temperature Rating	75°C

Applications

- Security Systems
- Intercom/PA Systems
- Sound/Audio Systems
- Power-Limited Controls

Solid Conductor



Stranded Conductor



Color Code Chart

Cond. No.	Color	Cond. No.	Color
1	Black	7	Orange
2	Red	8	Yellow
3	White	9	Purple
4	Green	10	Gray
5	Brown	11	Pink
6	Blue	12	Tan

Part No.	No. of Cond.	Stranding	Standard Lengths		Standard Unit Weight		Outer Jacket Thickness		Nominal OD	
			Ft.	m	Lbs.	kg	Inch	mm	Inch	mm

Unshielded Multi-conductor (NEC CMP and CEC CMP FT6)

22 AWG										
6520UE	2	solid	U-1000 1000	U-305 305	10.0 9.0	4.5 4.1	.015	.38	.118	3.00
6500UE	2	7	C-500 C-1000 U-1000 1000	C-152 C-305 U-305 305	4.5 9.0 10.0 10.0	2.0 4.1 4.5 4.5	.015	.38	.124	3.15
6521UE	3	solid	1000	305	13.0	5.9	.015	.38	.125	3.18
6501UE	3	7	U-1000 1000	U-305 305	14.0 13.0	6.4 5.9	.015	.38	.131	3.33
6522UE	4	solid	U-500 U-1000 1000	U-152 U-305 305	8.5 17.0 16.0	3.9 7.7 7.3	.015	.38	.136	3.45
6502UE	4	7	C-500 U-500 500 U-1000 1000	C-152 U-152 152 U-305 305	8.0 9.0 8.5 17.0 17.0	3.6 4.1 3.9 7.7 7.7	.015	.38	.143	3.63
6524UE	6	solid	C-500 U-1000	C-152 U-305	10.5 23.0	4.8 10.5	.015	.38	.162	4.11
6504UE	6	7	C-500 500 U-1000 1000	C-152 152 U-305 305	11.0 12.0 24.0 24.0	5.0 5.5 10.9 10.9	.015	.38	.171	4.34
6506UE	8	7	U-500 U-1000 1000	U-152 U-305 305	15.5 30.0 31.0	7.0 13.6 14.1	.015	.38	.186	4.72
6508UE	10	7	U-1000 1000	U-305 305	37.0 43.0	16.8 19.5	.015	.38	.218	5.54
6509UE	12	7	U-500 U-1000 1000	U-152 U-305 305	22.5 43.0 45.0	10.2 19.5 20.4	.015	.38	.225	5.72
20 AWG										
6400UE	2	7	C-500 500 U-1000 1000	C-152 152 U-305 305	6.0 7.0 14.0 14.0	2.7 3.2 6.4 6.4	.015	.38	.138	3.51
6401UE	3	7	U-1000 1000 5000	U-305 305 1524	19.0 18.0 90.0	8.6 8.2 40.9	.015	.38	.146	3.71
6402UE	4	7	U-1000 1000	U-305 305	24.0 24.0	10.9 10.9	.015	.38	.160	4.06
6403UE	5	7	U-1000 1000	U-305 305	28.0 28.0	12.7 12.7	.015	.38	.176	4.47
6406UE	8	7	1000	305	44.0	20.0	.015	.38	.209	5.31

Security and Alarm Cable

Commercial Applications
Unshielded, Plenum-Rated



Unshielded Multi-conductor *(cont'd.)* CMP FT6 Rated

Product Description

Bare copper conductors, Flamarrest® insulation, conductors cabled, Natural Flamarrest jacket, rip cord. Sequential footage marking every two feet.

Color Code: See chart below.

Specifications

Conductor	Bare Copper
Insulation	Flamarrest
Insulation Thickness	.009" (.229mm)
Jacket	Flamarrest
Approvals	
NEC	CMP
CEC	CMP FT6
NEC Articles	800
Voltage Rating	300V
Temperature Rating	75°C

Applications

- Security Systems
- Intercom/PA Systems
- Sound/Audio Systems
- Power-Limited Controls

Solid Conductor



Stranded Conductor



Color Code Chart

Cond. No.	Color	Cond. No.	Color
1	Black	7	Orange
2	Red	8	Yellow
3	White	9	Purple
4	Green	10	Gray
5	Brown	11	Pink
6	Blue	12	Tan

Part No.	No. of Cond.	Stranding	Standard Lengths		Standard Unit Weight		Outer Jacket Thickness		Nominal OD	
			Ft.	m	Lbs.	kg	Inch	mm	Inch	mm

Unshielded Multi-conductor (NEC CMP and CEC CMP FT6)

18 AWG										
6320UE	2	solid	U-1000	U-305	17.0	7.7	.015	.38	.147	3.73
6300UE*	2	7	C-500	C-152	8.0	3.6	.015	.38	.157	3.99
			U-500	U-152	9.5	4.3				
			500	152	9.0	4.1				
			U-1000	U-305	18.0	8.2				
			1000	305	18.0	8.2				
5000	1520	90.0	40.8							
6321UE	3	solid	U-1000	U-305	24.0	10.9	.015	.38	.156	3.96
			1000	305	24.0	10.9				
6301UE	3	7	500	152	12.5	5.7	.015	.38	.168	4.27
			U-1000	U-305	25.0	11.4				
			1000	305	25.0	11.4				
6322UE	4	solid	U-1000	U-305	30.0	13.6	.015	.38	.171	4.34
6302UE	4	7	C-250	C-76	8.5	3.9	.015	.38	.186	4.72
			C-500	C-152	17.0	7.7				
			U-500	U-152	18.5	8.4				
			500	152	18.5	8.4				
			U-1000	U-305	36.0	16.4				
1000	305	39.0	17.7							
5000	1524	180.0	81.7							
6303UE	5	7	U-1000	U-305	39.0	17.7	.015	.38	.203	5.16
			1000	305	40.0	18.1				
6304UE	6	7	U-500	U-152	23.5	10.7	.015	.38	.222	5.64
			500	152	23.0	10.4				
			1000	305	51.0	23.2				
6306UE	8	7	500	152	30.5	13.9	.015	.38	.242	6.15
			1000	305	65.0	29.5				
6307UE	9	7	1000	305	68.0	30.9	.015	.38	.262	6.65
6308UE	10	7	1000	305	75.0	34.1	.015	.38	.286	7.26
6309UE	12	7	1000	305	84.0	38.2	.015	.38	.296	7.52
16 AWG										
6200UE	2	19	500	152	13.0	5.9	.015	.38	.180	4.57
			U-1000	U-305	25.0	11.3				
			1000	305	26.0	11.8				
6201UE	3	19	500	152	18.0	8.2	.015	.38	.191	4.85
			U-1000	U-305	36.0	16.4				
			1000	305	37.0	16.8				
6202UE	4	19	500	152	24.0	10.9	.015	.38	.211	5.36
			U-1000	U-305	46.0	20.9				
			1000	305	52.0	23.6				

*6300UE also available in Gray and Black.

Security and Alarm Cable

Commercial Applications
Unshielded, Plenum-Rated



Unshielded Multi-conductor

CL2P Rated

Product Description

Bare copper conductors, Flamarrest® insulation, conductors cabled, Natural Flamarrest jacket, rip cord. Sequential footage marking every two feet.

Color Code: See chart below.

Specifications

Conductor	Bare Copper
Insulation	Flamarrest
Insulation Thickness	.011" (.279mm)
Jacket	Flamarrest
Approvals	
NEC	CL2P
NEC Articles	725
Voltage Rating	150V
Temperature Rating	75°C

Applications

- Security Systems
- Intercom/PA Systems
- Sound/Audio Systems
- Power-Limited Controls



Part No.	No. of Cond.	Stranding	Standard Lengths		Standard Unit Weight		Outer Jacket Thickness		Nominal OD	
			Ft.	m	Lbs.	kg	Inch	mm	Inch	mm

Unshielded Multi-conductor (NEC CL2P)

14 AWG										
6100UE	2	19	500	152	19.5	8.8	.015	.38	.222	5.64
			U-1000	U-305	38.0	17.2				
			1000	305	38.0	17.2				
			5000	1524	195.0	88.5				
6101UE	3	19	1000	305	56.0	25.4	.015	.38	.236	5.99
6102UE	4	19	1000	305	73.0	33.2	.015	.38	.261	6.63
12 AWG										
6000UE	2	19	500	152	32.0	14.5	.015	.38	.256	6.50
			1000	305	58.0	26.4				
6001UE	3	19	1000	305	83.0	37.7	.015	.38	.273	6.93
6002UE	4	19	1000	305	111.0	50.4	.018	.46	.308	7.82

Color Code Chart

Cond. No.	Color
1	Black
2	White
3	Red
4	Green

Security and Alarm Cable

Commercial Applications
Shielded, Plenum-Rated



Shielded Multi-conductor

CMP FT6 Rated

Product Description

Bare copper conductors, Flamarrest® insulation, conductors cabled, overall Beldfoil® tape shield (foil side out) and drain wire, Natural Flamarrest jacket with rip cord. Sequential footage marking every two feet.

Color Code: See chart below.

Specifications

Conductor	Bare Copper
Insulation	Flamarrest
Insulation Thickness	.009" (.229mm)
Shield	Beldfoil
Jacket	Flamarrest
Approvals	
NEC	CMP
CEC	CMP FT6
NEC Articles	800
Voltage Rating	300V
Temperature Rating	75°C

Applications

- Security Systems
- Intercom/PA Systems
- Sound/Audio Systems
- Power-Limited Controls

Solid Conductor



Shorting Fold

Stranded Conductor

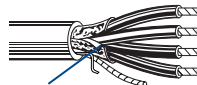

Shorting Fold

Color Code Chart

Cond. No.	Color	Cond. No.	Color
1	Black	7	Orange
2	Red	8	Yellow
3	White	9	Purple
4	Green	10	Gray
5	Brown	11	Pink
6	Blue	12	Tan

Part No.	No. of Cond.	Stranding	Standard Lengths		Standard Unit Weight		Outer Jacket Thickness		Nominal OD	
			Ft.	m	Lbs.	kg	Inch	mm	Inch	mm

Shielded Multi-conductor (NEC CMP and CEC CMP FT6)

22 AWG										
6520FE	2	solid	C-500	C-152	6.0	2.7	.015	.38	.122	3.10
			C-1000	C-305	12.0	5.4				
			U-1000	U-305	13.0	5.9				
			1000	305	13.0	5.9				
6500FE	2	7	C-500	C-152	5.5	2.5	.015	.38	.128	3.25
			U-500	U-152	7.0	3.2				
			500	152	7.0	3.2				
			C-1000	C-305	11.0	5.0				
			U-1000	U-305	13.0	5.9				
			1000	305	13.0	5.9				
6521FE	3	solid	1000	305	16.0	7.3	.015	.38	.129	3.28
6501FE	3	7	500	152	8.0	3.6	.015	.38	.135	3.43
			U-1000	U-305	16.0	7.3				
			1000	305	16.0	7.3				
6502FE	4	7	C-500	C-152	9.0	4.1	.015	.38	.147	3.73
			500	152	10.0	4.5				
			U-1000	U-305	19.0	8.6				
6504FE	6	7	C-500	C-152	9.0	4.1	.015	.38	.175	4.45
			U-500	U-152	13.5	6.1				
			500	152	13.5	6.1				
			U-1000	U-305	26.0	11.8				
6506FE	8	7	U-1000	U-305	33.0	15.0	.015	.38	.190	4.83
			1000	305	35.0	15.9				
6508FE	10	7	U-1000	U-305	40.0	18.1	.015	.38	.222	5.64
			1000	305	42.0	19.0				
20 AWG										
6420FE	2	solid	C-500	C-152	7.0	3.2	.015	.38	.134	3.40
			U-1000	U-305	16.0	7.3				
			1000	305	15.0	6.8				
6400FE	2	7	C-500	C-152	7.5	3.4	.015	.38	.142	3.61
			U-1000	U-305	17.0	7.7				
			1000	305	17.0	7.7				
6401FE	3	7	U-1000	U-305	21.0	9.5	.015	.38	.150	3.81
			1000	305	22.0	10.0				
6402FE	4	7	U-1000	U-305	26.0	11.8	.015	.38	.164	4.17
			1000	305	27.0	12.3				
6405FE	7	7	1000	305	41.0	18.6	.015	.38	.196	4.97
6407FE	9	7	1000	305	52.0	23.6	.015	.38	.229	5.82

Security and Alarm Cable

Commercial Applications
Shielded, Plenum-Rated



Shielded Multi-conductor (cont'd.)
CMP FT6 Rated or CL2P Rated

Product Description

Bare copper conductors, Flamarrest® insulation, conductors cabled, overall Beldfoil® tape shield (foil side out) and drain wire, Natural Flamarrest jacket with rip cord. Sequential footage marking every two feet.

Color Code: See chart below.

Specifications

Conductor	Bare Copper
Insulation	Flamarrest
Insulation Thickness	
18 and 16 AWG	.009" (.229mm)
14 and 12 AWG	.011" (.279mm)
Shield	Beldfoil
Jacket	Flamarrest
Approvals	
NEC (18 and 16 AWG)	CMP
CEC (18 and 16 AWG)	CMP FT6
NEC (14 and 12 AWG)	CL2P
NEC Articles	
18 and 16 AWG	800
14 and 12 AWG	725
Voltage Rating	
18 and 16 AWG	300V
14 and 12 AWG	150V
Temperature Rating	75°C

Applications

- Security Systems
- Intercom/PA Systems
- Sound/Audio Systems
- Power-Limited Controls

Solid Conductor

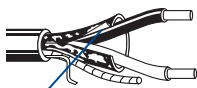

Shorting Fold

Stranded Conductor



Shorting Fold

Part No.	No. of Cond.	Stranding	Standard Lengths		Standard Unit Weight		Outer Jacket Thickness		Nominal OD	
			Ft.	m	Lbs.	kg	Inch	mm	Inch	mm

Shielded Multi-conductor (NEC CMP and CEC CMP FT6)

18 AWG										
6320FE	2	solid	C-500 1000	C-152 305	10.5 22.0	4.8 10.0	.015	.38	.150	3.89
6300FE	2	7	C-500 U-500 500 U-1000 1000	C-152 U-152 152 U-305 305	11.0 12.0 12.0 23.0 23.0	5.0 5.4 5.4 10.4 10.4	.015	.38	.162	4.11
6301FE	3	7	U-500 U-1000 1000	U-152 U-305 305	15.5 30.0 31.0	7.0 13.6 14.1	.015	.38	.172	4.37
6302FE	4	7	C-250 U-500 500 U-1000 1000	C-76 U-152 152 U-305 305	8.8 19.5 19.0 37.0 37.0	4.0 8.9 8.6 16.8 16.8	.015	.38	.188	4.78
6304FE	6	7	C-250 U-500 1000	C-76 U-152 305	12.0 25.5 52.0	5.4 11.6 23.6	.015	.38	.226	5.74
6306FE	8	7	1000	305	66.0	30.0	.015	.38	.246	6.25
6307FE	9	7	500 1000	152 305	39.5 73.0	18.0 33.2	.015	.38	.266	6.76
6309FE	12	7	500 1000	152 305	50.5 99.0	22.9 45.0	.018	.46	.306	7.77
16 AWG										
6200FE	2	19	500 1000	152 305	16.5 33.0	7.5 15.0	.015	.38	.184	4.67
6201FE	3	19	500 U-1000 1000	152 U-305 305	22.5 43.0 45.0	10.2 19.5 20.5	.015	.38	.195	4.95
6202FE	4	19	500 1000	152 305	29.0 59.0	13.2 26.8	.015	.38	.215	5.46

Shielded Multi-conductor (NEC CL2P)

14 AWG										
6100FE	2	19	500 U-1000 1000	152 U-305 305	25.0 49.0 51.0	11.3 22.2 23.1	.015	.38	.220	5.59
6101FE	3	19	1000	305	66.0	29.9	.015	.38	.234	5.94
12 AWG										
6000FE	2	19	500 1000	152 305	36.0 68.0	16.4 30.9	.015	.38	.260	6.60

Color Code Chart (18 to 16 AWG)

Cond. No.	Color	Cond. No.	Color
1	Black	7	Orange
2	Red	8	Yellow
3	White	9	Purple
4	Green	10	Gray
5	Brown	11	Pink
6	Blue	12	Tan

(14 to 12 AWG)

Cond. No.	Color
1	Black
2	White
3	Red

Security and Alarm Cable

Commercial Applications
Unshielded, Plenum-Rated



Unshielded Twisted Pairs

CMP FT6 Rated

Product Description

Bare copper conductors, Flamarrest® insulation, twisted into pairs, multiple pairs cabled together, Natural Flamarrest jacket with rip cord. Sequential footage marking every two feet.

Color Code: See chart below.

Specifications

Conductor	Bare Copper
Insulation	Flamarrest
Insulation Thickness	.009" (.229mm)
Jacket	Flamarrest
Approvals	
NEC	CMP
CEC	CMP FT6
NEC Articles	800
Voltage Rating	300V
Temperature Rating	75°C

Applications

- Security Systems
- Intercom/PA Systems
- Sound/Audio Systems
- Power-Limited Controls

Solid Conductor

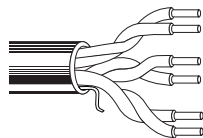

Stranded Conductor

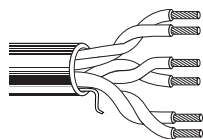

Color Code Chart

Pair No.	Color Combination	Pair No.	Color Combination
1	Black & Red	6	Black & Brown
2	Black & White	7	Black & Orange
3	Black & Green	8	Red & White
4	Black & Blue	9	Red & Green
5	Black & Yellow		

Part No.	No. of Pairs	Stranding	Standard Lengths		Standard Unit Weight		Outer Jacket Thickness		Nominal OD	
			Ft.	m	Lbs.	kg	Inch	mm	Inch	mm

Unshielded Twisted Pairs (NEC CMP and CEC CMP FT6)

22 AWG										
6561UE	2	solid	1000	305	19.0	8.6	.015	.38	.188	4.78
6541UE	2	7	U-1000 1000	U-305 305	19.0 20.0	8.6 9.1	.015	.38	.199	5.05
6542UE	3	7	1000	305	27.0	12.2	.015	.38	.212	5.38
6543UE	4	7	1000	305	34.0	15.4	.015	.38	.234	5.94
6545UE	6	7	1000	305	47.0	21.4	.015	.38	.264	6.71
6547UE	9	7	1000	305	69.0	31.4	.018	.46	.318	8.08
18 AWG										
6341UE	2	7	500 U-1000 1000	152 U-305 305	21.0 36.0 38.0	9.5 16.3 17.3	.015	.38	.260	6.60
6342UE	3	7	U-1000 1000	U-305 305	48.0 50.0	21.8 22.7	.015	.38	.278	7.06
6343UE	4	7	500 1000	152 305	37.5 66.0	17.0 30.0	.015	.38	.314	7.98
6345UE	6	7	1000	305	95.0	43.2	.018	.46	.355	9.02
6347UE	9	7	1000	305	138.0	62.7	.019	.48	.423	10.74

Security and Alarm Cable

Commercial Applications
Shielded, Plenum-Rated



Overall Shielded Twisted Pairs

CMP FT6 Rated

Product Description

Bare copper conductors, Flamarrest® insulation, twisted into pairs, multiple pairs cabled together, overall Beldfoil® shield tape (foil side out) with drain wire, Natural Flamarrest jacket with rip cord. Sequential footage marking every two feet.

Color Code: See chart below.

Specifications

Conductor	Bare Copper
Insulation	Flamarrest
Insulation Thickness	.009" (.229mm)
Shield	Beldfoil
Jacket	Flamarrest
Approvals	
NEC	CMP
CEC	CMP FT6
NEC Articles	800
Voltage Rating	300V
Temperature Rating	75°C

Applications

- Security Systems
- Intercom/PA Systems
- Sound/Audio Systems
- Power-Limited Controls

Solid Conductor

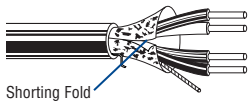

Stranded Conductor

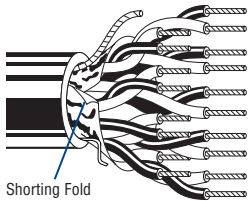

Color Code Chart

Pair No.	Color Combination	Pair No.	Color Combination
1	Black & Red	6	Black & Brown
2	Black & White	7	Black & Orange
3	Black & Green	8	Red & White
4	Black & Blue	9	Red & Green
5	Black & Yellow		

Part No.	No. of Pairs	Stranding	Standard Lengths		Standard Unit Weight		Outer Jacket Thickness		Nominal OD	
			Ft.	m	Lbs.	kg	Inch	mm	Inch	mm

Overall Shielded Twisted Pairs (NEC CMP and CEC CMP FT6)

22 AWG										
6561FE	2	solid	1000	305	21.0	9.5	.015	.38	.193	4.90
6541FE	2	7	U-500	U-152	11.5	5.2	.015	.38	.203	5.16
			U-1000	U-305	22.0	10.0				
			1000	305	23.0	10.4				
6542FE	3	7	U-1000	U-305	28.0	12.7	.015	.38	.216	5.49
			1000	305	29.0	13.2				
6543FE	4	7	U-1000	U-305	35.0	15.9	.015	.38	.238	6.05
			1000	305	41.0	18.6				
6545FE	6	7	U-1000	U-305	48.0	21.8	.015	.38	.268	6.80
			1000	305	50.0	22.7				
6547FE	9	7	1000	305	72.0	32.7	.018	.46	.323	8.20
20 AWG										
6441FE	2	7	1000	305	31.0	14.1	.015	.38	.228	5.79
6443FE	4	7	U-1000	U-305	49.0	22.2	.015	.38	.269	6.83
			1000	305	51.0	23.2				
18 AWG										
6342FE	3	7	500	152	28.0	12.7	.015	.38	.282	7.16
			1000	305	56.0	25.5				
6343FE	4	7	500	152	39.5	18.0	.015	.38	.318	8.08
			1000	305	74.0	33.6				
6345FE	6	7	500	152	50.0	22.7	.018	.46	.359	9.12
			1000	305	101.0	45.9				
6347FE	9	7	1000	305	145.0	65.8	.019	.48	.427	10.85

Security and Alarm Cable

Commercial Applications
Shielded, Plenum-Rated



**Shielded
Twisted Pair plus Conductor(s)**
CMP FT6 Rated

Product Description

Bare copper conductors, Flamarrest® insulation, Black/Red twisted pair shielded with Beldfoil® tape (aluminum side facing in), drain wire, cabled with additional insulated conductor(s) as indicated, Natural Flamarrest jacket with rip cord. Sequential footage marking every two feet.

Color Code: Black & Red pair, White, Green.

Specifications

Conductor	Bare Copper
Insulation	Flamarrest
Insulation Thickness	.009" (.229mm)
Shield	Beldfoil
Jacket	Flamarrest
Approvals	
NEC	CMP
CEC	CMP FT6
NEC Articles	800
Voltage Rating	300V
Temperature Rating	75°C

Applications

- Security Systems
- Intercom/PA Systems
- Sound/Audio Systems
- Power-Limited Controls



Shorting Fold

Part No.	No. of Pairs + No. of Cond.	Stranding	Standard Lengths		Standard Unit Weight		Outer Jacket Thickness		Nominal OD	
			Ft.	m	Lbs.	kg	Inch	mm	Inch	mm
Shielded Twisted Pair plus Conductor(s) (NEC CMP and CEC CMP FT6)										
22 AWG										
6501GE	1 STP +1/C	7	1000	305	18.0	8.2	.015	.38	.174	4.42
6502GE	1 STP +2/C	7	U-1000 1000	U-305 305	21.0 21.0	9.5 9.5	.015	.38	.180	4.57
20 AWG										
6401GE	1 STP +1/C	7	1000	305	24.0	10.9	.015	.38	.195	4.95

STP = Shielded Twisted Pair(s) • /C = Conductor(s)

20 • New Generation® Cables

Communication and Control Cable

Pro Audio and Intercom Systems
Unshielded



**Unshielded,
Pairs or Multi-conductor**
CM FT1 Rated*

Product Description

Bare copper conductors, polypropylene (multiconductor) or polyolefin (paired) insulation, PVC jacket with rip cord (except 5626UG and 5624UG which do not have rip cord).

5500 Series available in Beige, Brown, Orange, Yellow, Green, Blue, Purple, Gray or White jacket colors (except as noted in footnote). Conductors may not be cabled. Sequential footage marking every two feet. **5600 Series** available in Dark Gray.

Color Code: See charts below.

Specifications

Conductor	Bare Copper
Insulation	
Multiconductor	Polypropylene
Paired	Polyolefin
Insulation Thickness	
5500 Series	.0060" (.152mm)
5600 Series	.0065" (.165mm)
Jacket	PVC
Approvals	
NEC	CM
CEC	CM FT1*
Voltage Rating	300V

*Only 5520UG and 5522UG are CEC/CM FT1 rated

Applications (5500)

- Security Systems
- Intercom/PA Systems
- Sound/Audio Systems
- Power-Limited Controls
- Single Line Telephone

Applications (5600)

- Nurse Call Systems
- Annunciators
- Voice Systems
- Paging
- Commercial Sound Systems

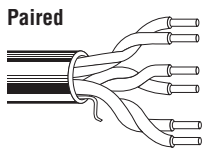

Multi-conductor

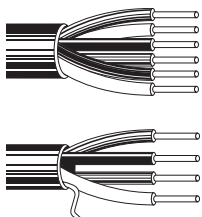

Part No.	No. of Cond.	Stranding	Standard Lengths		Standard Unit Weight		Outer Jacket Thickness		Nominal OD	
			Ft.	m	Lbs.	kg	Inch	mm	Inch	mm

Unshielded, Pairs (NEC CM and CEC CM FT1)

24 AWG, Cat. 5e										
5662UG <small>NEW</small>	6	solid	1000	304.8	16.0	8.62	—	—	.172	4.37

Unshielded, Multi-conductor (NEC CM and CEC CM)

24 AWG										
5626UG <small>NEW</small>	8	solid	1000	304.8	29.0	13.15	.030	.762	.093	2.36
									X	X
									.324	8.23
5624UG <small>NEW</small>	6	solid	1000	304.8	19.0	8.62	.024	.610	.081	2.06
									X	X
									.246	6.25

Unshielded Multi-conductor (NEC CM and CEC CM FT1)

22 AWG										
5522UG [†] <small>NEW</small>	4	solid	C-500	C-152	6.0	2.7	.015	.38	.122	3.10
			C-1000	C-305	12.0	5.4				
5520UG <small>NEW</small>	2	solid	C-500 ♦	C-152	3.5	1.6	.015	.38	.106	2.69
			C-1000	C-305	7.0	3.2				

[†] 5522UG available in White only.

♦ 5520UG C-500 ft. put-up available in Gray or White only.

Color Code Chart — Paired (5662UG)

Pair No.	Color Combinations
1	White/Blue Stripe & Blue
2	White/Orange Stripe & Orange
3	White/Green Stripe & Green

Color Code Chart (5626UG)

Cond. No.	Color
1	Yellow
2	Blue
3	Black
4	Orange
5	Red
6	Green
7	White
8	Purple

Color Code Chart (5624UG)

Cond. No.	Color
1	Blue
2	Black
3	Orange
4	Red
5	Green
6	White

Color Code Chart (5522UG, 5520UG)

Cond. No.	Color
1	Black
2	Red
3	White
4	Green



Communication and Control Cable

Pro Audio and Intercom Systems
Unshielded, Plenum-Rated



**Unshielded,
Pairs or Multi-conductor**
CMP FT6 Rated

Product Description

24 AWG solid bare copper conductors, FEP insulation, Dark Gray Flamarrest® jacket with rip cord.

Color Code: See Charts below.

Specifications

Conductor	Bare Copper
Insulation	FEP
Insulation Thickness	.007" (.178mm)
Jacket	Flamarrest
Nominal Capacitance	15 pF/ft.
Approvals	
NEC	CMP
CEC	CMP FT6
Voltage Rating	300V

Applications

- Nurse Call Systems
- Commercial Sound Systems
- Annunciators
- Voice Systems
- Paging

Paired

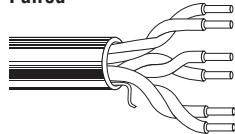

Multi-conductor



Part No.	No. of Cond.	Stranding	Standard Lengths		Standard Unit Weight		Outer Jacket Thickness		Nominal OD	
			Ft.	m	Lbs.	kg	Inch	mm	Inch	mm

Plenum-rated, Unshielded, Pairs (NEC CMP and CEC CMP FT4, FT6)

24 AWG, Cat. 5e										
6662UG <small>NEW</small>	6	solid	1000	304.8	23.0	10.4	—	—	.165	4.19

Plenum-rated, Unshielded, Multi-conductor (NEC CMP and CEC CMP FT6)

24 AWG										
6626UG <small>NEW</small>	8	solid	1000	304.8	28.0	12.70	.019	.483	.072	1.83
									x	x
									.310	7.87
6624UG <small>NEW</small>	6	solid	1000	304.8	21.0	9.53	.019	.483	.072	1.83
									x	x
									.246	6.25

Color Code Chart

(6662UG)

Pair No.	Color Combinations
1	White/Blue Stripe & Blue
2	White/Orange Stripe & Orange
3	White/Green Stripe & Green

Color Code Chart

(6626UG)

Cond. No.	Color
1	Yellow
2	Blue
3	Black
4	Orange
5	Red
6	Green
7	White
8	Purple

Color Code Chart

(6624UG)

Cond. No.	Color
1	Blue
2	Black
3	Orange
4	Red
5	Green
6	White

Communication and Control Cable

Pro Audio and Intercom Systems
Shielded, Plenum-Rated



Shielded Multi-conductor

CMP FT6 Rated

Product Description

Bare copper conductors, FEP insulation, conductors cabled with a Beldfoil® shield tape (foil side out) and drain wire. Natural Flamarrest® jacket with rip cord. Sequential footage marking every two feet.

Color Code: See chart below.

Specifications

Conductor	Bare Copper
Insulation	FEP
Insulation Thickness	
22 AWG	.0055" (.140mm)
20 AWG	.0060" (.152mm)
18 AWG	.0060" (.152mm)
Shield	Beldfoil
Jacket	Flamarrest
Approvals	
NEC	CMP
CEC	CMP FT6
NEC Articles	800
Voltage Rating	300V
Temperature Rating	75°C

Applications

- Pro Audio Systems
- Intercom/PA Systems
- Security Systems

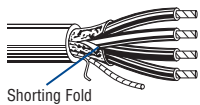

Part No.	No. of Cond.	Stranding	Standard Lengths		Standard Unit Weight		Outer Jacket Thickness		Nominal OD	
			Ft.	m	Lbs.	kg	Inch	mm	Inch	mm

Shielded Multi-conductor (NEC CMP and CEC CMP FT6)

22 AWG										
6500FC	2	7	U-1000	U-305	11.0	5.0	.015	.38	.116	2.95
			1000	305	11.0	5.0				
6502FC										
	4	7	1000	305	18.0	8.2	.015	.38	.133	3.38
20 AWG										
6400FC										
	2	7	U-1000	U-305	15.0	6.8	.015	.38	.133	3.38
18 AWG										
6300FC										
	2	7	U-1000	U-305	23.0	10.4	.017	.42	.155	3.94
			1000	305	22.0	10.0				
6302FC										
	4	7	U-1000	U-305	34.0	15.5	.017	.42	.179	4.55
			1000	305	36.0	16.3				

Color Code Chart

Cond No.	Color
1	Black
2	Red
3	White
4	Green

Communication and Control Cable

Pro Audio and Intercom Systems
Overall Shielded, Plenum-Rated



Overall Shielded Pairs

CMP FT6 Rated

Product Description

Bare copper conductors, FEP insulation, twisted pairs cabled with a Beldfoil® shield tape (foil side out) and drain wire. Natural Flamarrest® jacket.

Color Code: Black & Red and Black & White pairs.

Specifications

Conductor	Bare Copper
Insulation	FEP
Insulation Thickness	.0060" (.152mm)
Shield	Beldfoil
Jacket	Flamarrest
Approvals	
NEC	CMP
CEC	CMP FT6
NEC Articles	800
Voltage Rating	300V
Temperature Rating	75°C

Applications

- Pro Audio Systems
- Intercom/PA Systems
- Security Systems



Part No.	No. of Pairs	Stranding	Standard Lengths		Standard Unit Weight		Outer Jacket Thickness		Nominal OD	
			Ft.	m	Lbs.	kg	Inch	mm	Inch	mm

Overall Shielded Pairs (NEC CMP and CEC CMP FT6)

24 AWG										
6641FC	2	7	U-500	U-152	8.0	3.6	.015	.38	.164	4.17

Communication and Control Cable

Pro Audio and Intercom Systems
Individually Shielded, Plenum-Rated



Individually Shielded Twisted Pairs

CMP FT6 Rated

Product Description

Bare copper conductors, FEP insulation (per table). Conductors twisted into pairs and individually shielded with Beldfoil® tape (aluminum side facing in) and a drain wire, multiple pairs cabled together, Gray Fluorocopolymer (22 AWG) or Natural Flammarrest® (18 AWG) jacket, rip cord. Sequential footage marking every two feet.

Color Code: See chart below.

Specifications

Conductor	Bare Copper
Insulation	FEP
Insulation Thickness	.010" (.254mm)
Shield	Beldfoil
Jacket	
22 AWG	Gray Fluorocopolymer
18 AWG	Natural Flammarrest
Nominal Capacitance	
22 AWG	27.5 pF/ft.
18 AWG	44 pF/ft.
Approvals	
NEC	CMP
CEC	CMP FT6
NEC Articles	800
Voltage Rating	300V
Temperature Rating	75°C

Part No.	No. of Pairs	Stranding	Standard Lengths		Standard Unit Weight		Outer Jacket Thickness		Nominal OD	
			Ft.	m	Lbs.	kg	Inch	mm	Inch	mm

Individually Shielded Twisted Pairs (NEC CMP and CEC CMP FT6)

22 AWG										
6541PA	2	7	500	152	13.5	6.1	.015	.38	.214	5.44
			U-1000	U-305	26.0	11.8				
			1000	305	27.0	12.3				
6542PA	3	7	1000	305	36.0	16.3	.015	.38	.228	5.79
6543PA	4	7	1000	305	45.0	20.4	.015	.38	.252	6.40
6545PA	6	7	1000	305	60.0	27.2	.015	.38	.300	7.62
6546PA	8	7	1000	305	85.0	38.6	.017	.42	.332	8.43
6548PA	12	7	1000	305	125.0	56.8	.017	.42	.408	10.36
6549PA	16	7	1000	305	162.0	73.5	.017	.42	.457	11.61
18 AWG										
6341PC	2	7	500	152	26.5	12.0	.017	.42	.281	7.14
			U-1000	U-305	47.0	21.3				
			1000	305	49.0	22.2				
6342PC	3	7	500	152	32.0	14.5	.017	.42	.300	7.62
			1000	305	64.0	29.0				
6343PC	4	7	1000	305	83.0	37.7	.017	.42	.332	8.43
6345PC	6	7	500	152	66.5	30.2	.019	.48	.402	10.21
			1000	305	132.0	59.9				

Applications

- Security Systems
- Intercom/PA Systems
- Sound/Audio Systems
- Power-Limited Controls
- Analog Multi-pair Snakes

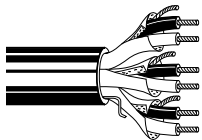

Color Code Chart

Pair No.	Color Combination	Pair No.	Color Combination	Pair No.	Color Combination
1	Black & Red	6	Black & Brown	11	Red & Yellow
2	Black & White	7	Black & Orange	12	Red & Brown
3	Black & Green	8	Red & White	13	Red & Orange
4	Black & Blue	9	Red & Green	14	Green & White
5	Black & Yellow	10	Red & Blue	15	Green & Blue
				16	Green & Yellow

Thermostat & Control Cable

Commercial Applications
Shielded



Overall Shielded Twisted Pairs CMR/CMG FT4 Rated

Product Description

Tinned copper conductors, Datalene® insulation. Conductors twisted into pairs, overall Beldfoil® shield (100% coverage), tinned copper drain wire, overall Brown PVC jacket. Sequential footage marking every two feet.

Color Code: Black & White, Green & Red.

Specifications

Conductor	Bare Copper
Insulation	Datalene
Shield	Beldfoil
Jacket	PVC
Approvals	
NEC	CMR
CEC	CMG FT4
Voltage Rating	300V
Temperature Rating	75°C

Applications

- Thermostat and control cable

Stranded Conductor



Solid Conductor



Part No.	No. of Pairs	Stranding	Standard Lengths		Standard Unit Weight		Outer Jacket Thickness		Nominal OD	
			Ft.	m	Lbs.	kg	Inch	mm	Inch	mm

Overall Shielded Twisted Pairs (NEC CMR and CEC CMG FT4)

24 AWG										
5660FT	1	solid	1000	305	11.0	5.0	.015	.38	.138	3.50
5661PT	2	solid	1000	305	18.0	8.2	.015	.38	.165	4.19
22 AWG										
5540FT	1	7	1000	305	15.0	6.8	.015	.38	.172	4.37
5541PT	2	7	1000	305	25.0	11.3	.015	.38	.202	5.13
18 AWG										
5340FT	1	7	1000	305	34.0	15.4	.015	.38	.260	6.60
5341PT	2	7	1000	305	58.0	26.3	.015	.38	.308	7.82

20 • New Generation® Cables

Thermostat & Control Cable

Commercial Applications
Shielded, Plenum-Rated



Overall Shielded Twisted Pairs

CMP FT6 Rated

Product Description

Tinned copper conductors, Foam Fluorinated Ethylene Propylene (FFEP) insulation. Conductors twisted into pairs, overall Beldfoil® shield (100% coverage), tinned copper drain wire, overall Brown Flamarrest® jacket. Sequential footage marking every two feet.

Color Code: Black & White, Green & Red.

Specifications

Conductor	Bare Copper
Insulation	FFEP
Shield	Beldfoil
Jacket	Flamarrest
Approvals	
NEC	CMP
CEC	CMP FT6
Voltage Rating	300V
Temperature Rating	75°C

Applications

- Thermostat and control cable

Stranded Conductor



Solid Conductor



Part No.	No. of Pairs	Stranding	Standard Lengths		Standard Unit Weight		Outer Jacket Thickness		Nominal OD	
			Ft.	m	Lbs.	kg	Inch	mm	Inch	mm

Overall Shielded Twisted Pairs (NEC CMP and CEC CMP FT6)

24 AWG										
6660FT	1	solid	1000	305	11.0	5.0	.015	.38	.128	3.25
6661PT	2	solid	1000	305	19.0	8.6	.015	.38	.155	3.94
22 AWG										
6540FT	1	7	1000	305	32.0	6.8	.015	.38	.162	4.12
6541PT	2	7	1000	305	28.0	12.7	.015	.38	.192	4.88
18 AWG										
6340FT	1	7	1000	305	32.0	6.8	.015	.38	.260	6.60
6341PT	2	7	1000	305	60.0	27.2	.015	.38	.280	7.11

Access Control Banana Peel® Cable

Lock Power, Card Reader, Door Contact, REX Applications
Plenum-Rated



Composite Shielded Multi-Conductors
CMP FT6 Rated

Product Description

Stranded bare copper conductors, Flammarrest® insulation and jackets. No overall jacket. All cables are Beldfoil® shielded (100% coverage) with drain wire and rip cord. Cable jackets are color coded by application. Individual jacket is sequentially marked at two foot intervals.

Specifications

Conductor	Bare Copper
Insulation	Flammarrest
Shield	Beldfoil
Individual Jackets	Flammarrest
Overall Jacket	None
Approvals	
NEC	CMP
CEC	CMP FT6
NEC Articles	800
Voltage Rating	300V
Temperature Rating	75°C

Applications

- Security Systems
- Power-Limited Controls
- Access Control
- Card Reader
- Lock Power
- Door Control
- REX

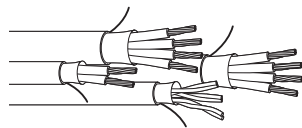

Individual Cable Jacket Color Coding System

Jacket Color	Print Legend	Cable Type
Orange	Card Reader	3/P, 18 or 22 AWG, Shielded
White	Door Contact	2/C, 18 or 22 AWG, Shielded
Blue	Rex/Spare	4/C, 18 or 22 AWG, Shielded
Gray	Lock Power	4/C, 16 or 18 AWG, Shielded

Part No.	Component Descriptions	Insulation Material & (Color Code)	Jacket Material & Component OD		Overall Nom. OD		Standard Lengths		Standard Unit Weight	
			Inch	mm	Inch	mm	Ft.	m	Lbs.	kg

Composite Shielded Multi-Conductors (NEC CMP and CEC CMP FT6)

(3) Shielded Multi-Conductors • (1) Shielded Multi-Pair										
658AFS <small>NEW</small>	(1) 3-Pair 22 AWG Stranded (7x30) Bare Copper Shielded	Flammarrest (Black & Red, White & Green, Orange & Brown)	Orange Flammarrest	.420	10.67	500	152	60	27.2	
	(1) 2-Cond. 22 AWG Stranded (7x30) Bare Copper Shielded	Flammarrest (Black, Red)	White Flammarrest	.131	3.33	1000	304	113	51.3	
	(1) 4-Cond. 22 AWG Stranded (7x30) Bare Copper Shielded	Flammarrest (Black, Red, White, Green)	Blue Flammarrest	.150	3.81					
	(1) 4-Cond. 18 AWG Stranded (7x26) Bare Copper Shielded	Flammarrest (Black, Red, White, Green)	Gray Flammarrest	.191	4.85					
638AFS <small>NEW</small>	(1) 3-Pair 18 AWG Stranded (7x26) Bare Copper Shielded	Flammarrest (Black & Red, White & Green, Orange & Brown)	Orange Flammarrest	.542	13.77	1000	305	189	85.7	
	(1) 2-Cond. 18 AWG Stranded (7x26) Bare Copper Shielded	Flammarrest (Black, Red)	White Flammarrest	.168	4.27					
	(1) 4-Cond. 18 AWG Stranded (7x26) Bare Copper Shielded	Flammarrest (Black, Red, White, Green)	Blue Flammarrest	.197	5.00					
	(1) 4-Cond. 16 AWG Stranded (19x30) Bare Copper Shielded	Flammarrest (Black, Red, White, Green)	Gray Flammarrest	.224	5.69					

U.S. Patent 7,049,523

Access Control Banana Peel® Cable

Lock Power, Card Reader, Door Contact, REX Applications
Riser-Rated



Composite Shielded Multi-Conductors CMR/CMG Rated

Product Description

Stranded bare copper conductors, PVC or Flame-retardant PVC insulation and jackets. No overall jacket. All cables are Beldfoil® shielded (100% coverage) with drain wire and rip cord. Cable jackets are color coded by application. Individual jacket is sequentially marked at two foot intervals.

Specifications

Conductor	Bare Copper
Insulation	PVC or FR-PVC
Shield	Beldfoil
Individual Jackets	PVC or FR-PVC
Overall Jacket	None
Approvals	
NEC	CMR
CEC	CMG
NEC Articles	800
Voltage Rating	300V
Temperature Rating	75°C

Applications

- Security Systems
- Power-Limited Controls
- Access Control
- Card Reader
- Lock Power
- Door Control
- REX

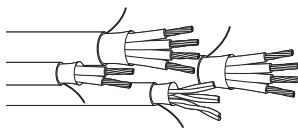

Individual Cable Jacket Color Coding System

Jacket Color	Print Legend	Cable Type
Orange	Card Reader	3/P, 18 or 22 AWG, Shielded
White	Door Contact	2/C, 18 or 22 AWG, Shielded
Blue	Rex/Spare	4/C, 18 or 22 AWG, Shielded
Gray	Lock Power	4/C, 16 or 18 AWG, Shielded

Part No.	Component Descriptions	Insulation Material & (Color Code)	Jacket Material & Component OD		Overall Nom. OD		Standard Lengths		Standard Unit Weight	
			Inch	mm	Inch	mm	Ft.	m	Lbs.	kg

Composite Shielded Multi-Conductors (NEC CMR and CEC CMG)

(3) Shielded Multi-Conductors • (1) Shielded Multi-Pair										
558AFS <small>NEW</small>	(1) 3-Pair 22 AWG Stranded (7x30) Bare Copper Shielded	F-R PVC (Black & Red, White & Green, Orange & Brown)	Orange FR-PVC .233	11.38	.448	500	152	59	26.5	
	(1) 2-Cond. 22 AWG Stranded (7x30) Bare Copper Shielded	F-R PVC (Black, Red)	White FR-PVC .140	3.56		1000	305	108	49.0	
	(1) 4-Cond. 22 AWG Stranded (7x30) Bare Copper Shielded	F-R PVC (Black, Red, White, Green)	Blue FR-PVC .161	4.09						
	(1) 4-Cond. 18 AWG Stranded (7x26) Bare Copper Shielded	F-R PVC (Black, Red, White, Green)	Gray FR-PVC .202	5.13						
538AFS <small>NEW</small>	(1) 3-Pair 18 AWG Stranded (7x26) Bare Copper Shielded	PVC (Black & Red, White & Green, Orange & Brown)	Orange PVC .285	7.24	.516	13.11	1000	305	182	82.6
	(1) 2-Cond. 18 AWG Stranded (7x26) Bare Copper Shielded	PVC (Black, Red)	White PVC .175	4.45						
	(1) 4-Cond. 18 AWG Stranded (7x26) Bare Copper Shielded	PVC (Black, Red, White, Green)	Blue PVC .202	5.13						
	(1) 4-Cond. 16 AWG Stranded (19x30) Bare Copper Shielded	PVC (Black, Red, White, Green)	Gray PVC .230	5.84						

F-R = Flame-retardant
U.S. Patent 7,049,523

Security Coaxial Cable

Surveillance and CCTV Applications
Shielded or Flooded for Use in Underground Ducts



Coax
CM FT1 Rated

Product Description

Bare copper conductor, foam polyethylene insulation, bare copper braid shield. Black PVC jacket. Sequential footage marking every two feet.

Water-blocked Coax

CM FT1 Rated

Product Description

Bare copper conductor, foam polyolefin insulation, foil plus braid shield as shown per item, braid impregnated with CoreGuard® flame retardant flooding compound, Black UV resistant PVC jacket. Sequential footage marking every two feet.

Specifications

Conductor	Bare Copper
Insulation	FPE
Shield	
Coax	Bare Copper Braid
Water-blocked Coax	Foil + Braid
Jacket	PVC
Approvals	
NEC	CM
CEC	CM FT1
NEC Articles	800
Nominal Impedance	75Ω
Temperature Rating	75°C

Applications

- CCTV
- Video Security Coax

Solid Conductor

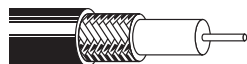

Stranded Conductor

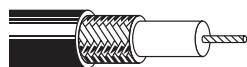

Water-blocked

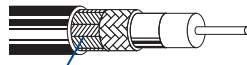

CoreGuard

Part No.	AWG	Stranding and Conductor	Shield/Braid Coverage	Insulation Nominal OD		Nominal OD		Standard Lengths		Standard Unit Weight	
				Inch	mm	Inch	mm	Ft.	m	Lbs.	kg

Coax (NEC CM and CEC CM FT1)

Mini RG-59 Type											
573945*	25	solid BC	94% BC	.085	2.16	.146	3.71	U-1000	U-305	15.0	6.8
								1000	305	14.0	6.4

RG-59 Type											
551945	22	7/w BC	95% BC	.140	3.56	.232	5.89	U-1000	U-305	33.0	15.0
								1000	305	30.0	13.6

543945*	20	solid BC	95% BC	.145	3.68	.232	5.89	U-500	U-152	12.5	5.7
								500	152	13.0	6.0
								U-1000	U-305	25.0	11.3
								1000	305	31.0	14.1

RG-6 Type											
533945*	18	solid BC	95% BC	.180	4.57	.266	6.76	500	152	21.0	9.5
								U-1000	U-305	40.0	18.1
								1000	305	41.0	18.6

RG-11 Type											
513945	14	solid BC	95% BC	.280	7.11	.405	10.29	500	152	52.5	23.8
								1000	305	98.0	44.5

Water-blocked Coax (NEC CM and CEC CM FT1)

RG-59 Type											
5439W5	20	solid BC	Duobond® II + 95% tinned copper braid	.145	3.68	.236	5.99	U-500	U-152	17.5	7.9
								500	152	17.5	7.9
								U-1000	U-305	34.0	15.4
								1000	305	34.0	15.4

RG-6 Type											
5339W5	18	solid BC	Duofoil® + 60% aluminum braid	.180	4.57	.270	6.86	U-500	U-152	15.5	7.0
								500	152	15.5	7.0
								U-1000	U-305	30.0	13.6
								1000	305	30.0	13.6

BC = Bare Copper

*Available in other jacket colors. Consult www.belden.com.

Security Composite Cable

CCTV plus Audio or Power or Pan and Tilt CCTV Control Applications
Plenum-Rated and Non-Plenum



Non-Plenum Composite Coax plus Twisted Pair

CM FT1 or CMG-LS FT4 Rated

Product Description

Coax: Solid bare copper conductor, foam polyolefin insulation, bare copper braid shield. Black PVC jacket (1306SB has Black LSZH jacket).

Pair: Stranded bare copper conductor, PVC insulation, Black PVC jacket. (1306SB has polypropylene insulation. Black LSZH jacket.) Color coded: Black & Red.

Plenum-Rated Composite Coax plus Twisted Pair

CMP FT6 Rated

Product Description

Coax: Solid bare copper conductor, FEP insulation, bare copper braid shield, Natural Flamarrest® jacket.

Pair: Stranded FEP insulation, Natural Flamarrest jacket. Color coded: Black & Red.

Coax and pair in Siamese configuration. Sequential footage marking every two feet.

Specifications

Conductor	Bare Copper
Insulation (Non-Plenum)	FPO Coax Pair PVC
Insulation (Plenum)	FEP
Shield (Coax)	Bare Copper Braid
Jacket	PVC Non-Plenum Flamarrest Plenum
Approvals (Non-Plenum)	CM NEC CEC CM FT1
Approvals (LSZH)	CMG-LS NEC CEC CMG-LS FT4 Limited Smoke
Approvals (Plenum)	CMP NEC CEC CMP FT6
NEC Articles	800
Nominal Impedance (Coax)	75Ω
Temperature Rating	75°C

Applications

- CCTV plus Audio or Power
- Pan, Tilt and Zoom CCTV Control



Part No.	AWG	Stranding and Conductor	Shield/Braid Coverage	Insulation Nominal OD		Nominal OD		Standard Lengths		Standard Unit Weight	
				Inch	mm	Inch	mm	Ft.	m	Lbs.	kg

CM-Rated Composite (NEC CM and CEC CM FT1)

Mini RG-59 Type											
579945 <small>new</small>	25(cx)	solid BC	95% BC	.085	2.16	.151	3.84	500	152	15.0	6.8
	20(pr)	7/w BC	unshielded	.056	1.42	x	x	1000	305	29.0	13.2
											.332 8.43

RG-59 Type											
549945	20(cx)	solid BC	95% BC	.145	3.68	.232	5.89	500	152	30.0	13.6
	18(pr)	7/w BC	unshielded	.066	1.68	x	x	1000	305	60.0	27.3
											.460 11.68

RG-6 Type											
539945	18(cx)	solid BC	95% BC	.180	4.57	.266	6.76	500	152	34.0	15.5
	18(pr)	7/w BC	unshielded	.066	1.68	x	x	1000	305	69.0	31.3
											.500 12.70

CMG-LS -Rated Composite (NEC CMG-LS and CEC CMG-LS FT4 Limited Smoke)

RG-6 Type											
1306SB <small>new</small>	18(cx)	solid BC	95% BC	.180	4.57	.275	6.99	500	152	37.0	16.8
	18(pr)	7/w BC	unshielded	.059	1.59	x	x	1000	305	76.0	34.5
											.514 13.06

Plenum-Rated Composite (NEC CMP and CEC CMP FT6)

Mini RG-59 Type											
679948* <small>new</small>	25(cx)	solid BC	95% BC	.078	1.98	.144	3.66	500	152	16.5	7.4
	20(pr)	7/w BC	unshielded	.048	1.22	x	x	1000	305	34.0	15.5
											.328 8.33

RG-59 Type											
649948	20(cx)	solid BC	95% BC	.134	3.40	.199	5.05	500	152	29.0	13.2
	18(pr)	7/w BC	unshielded	.059	1.50	x	x	1000	305	54.0	24.5
											.383 9.72

RG-6 Type											
639948	18(cx)	solid BC	95% BC	.170	4.32	.232	5.89	500	152	32.0	14.5
	18(pr)	7/w BC	unshielded	.059	1.50	x	x	1000	305	60.0	27.2
											.416 10.57

BC = Bare Copper • cx = Coax • pr = Pair • LSZH = Low-Smoke, Zero-Halogen

*679948 also available in White.

Security Coaxial Cable

CCTV and Card Reader/Sensor Applications
Plenum-Rated



Plenum-Rated Coax

CMP FT6 Rated

Product Description

Bare copper or copper-covered steel conductor, foam FEP insulation, bare copper braid shield. Natural Flamarrest® jacket (except 613948 which is White fluorocopolymer). Sequential footage marking every two feet.

Specifications

Conductor	Solid BC or BCCS
Insulation	Foam FEP
Shield	Bare Copper Braid
Jacket	Flamarrest†
Approvals	
NEC	CMP
CEC	CMP FT6
NEC Articles	800
Nominal Impedance	75Ω
Nominal Impedance (6539Y8 only)	93Ω
Temperature Rating	75°C

†613948 jacket is White fluorocopolymer.

Applications

- CCTV
- Card Reader/Sensor (6539Y8)

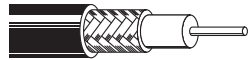

Part No.	AWG	Stranding and Conductor	Shield/Braid Coverage	Insulation Nominal OD		Nominal OD		Standard Lengths		Standard Unit Weight	
				Inch	mm	Inch	mm	Ft.	m	Lbs.	kg

Plenum-Rated Coax for CCTV (NEC CMP and CEC CMP FT6)

Mini RG-59 Type											
673948	25	solid BC	95% BC	.078	1.98	.146	3.71	U-500	U-152	9.0	4.1
								U-1000	U-305	17.0	7.7
								1000	305	17.0	7.7

RG-59 Type											
643948*	20	solid BC	95% BC	.135	3.43	.193	4.90	U-500	U-152	16.0	7.3
								500	152	17.5	8.0
								U-1000	U-305	30.0	13.6
								1000	305	32.0	14.5

RG-6 Type											
633948	18	solid BC	95% BC	.170	4.32	.228	5.79	U-500	U-152	20.5	9.8
								500	152	20.5	9.8
								U-1000	U-305	40.0	18.1
								1000	305	42.0	19.1

RG-11 Type											
613948	14	solid BC	95% BC	.274	6.96	.348	8.84	500	152	44.5	20.2
								1000	305	90.0	40.9

*643948 also available in Black jacket.

Plenum-Rated Coax for Card Readers/Sensors (NEC CMP, CEC CMP FT6)

RG-62 Type											
6539Y8	22	solid BCCS	95% BC	.146	3.71	.204	5.18	U-1000	U-305	31.0	14.1
								1000	305	33.0	15.0

BC = Bare Copper • BCCS = Bare Copper-covered Steel

Security UTP Cable

CCTV Fixed and PTZ Applications

Riser-Rated



Non-Plenum

CM FT1 or CMR FT4 Rated

Product Description

Solid bare copper conductors, unshielded twisted pairs, polyolefin insulation, PVC jacket with rip cord. Sequential footage marking every two feet.

Specifications

Conductor	Solid Bare Copper
Shield	Unshielded
Jacket	PVC
Approvals	CM or CMR NEC CEC CM FT1 or CMR FT4
Nominal Impedance	100Ω
Temperature Rating	80°C

Applications:

- 100BaseTX
- 100BaseVG ANYLAN
- 155ATM
- 622ATM
- AES/EBU
- Digital Video, RS-422
- Gigabit Ethernet
- NTSC/PAL Component or Composite Video
- Premise Horizontal Cable
- CCTV UTP
- PTZ
- Pan/Tilt/Zoom



Part No.	Component Descriptions	Insulation Material	Insulation Nominal OD		Nominal OD		Standard Lengths		Standard Unit Weight	
			Inch	mm	Inch	mm	Ft.	m	Lbs.	kg

Non-Plenum (NEC CM and CEC CM FT1)

Category 5e										
1583A <small>NEW</small>	4-Pair UTP	Polyolefin	.008	0.20	.195	4.95	U-1000	U-305	21.0	9.5
	24 AWG						1000	305	21.0	9.5
	Solid						1640	500	34.4	15.7
	Bare Copper Cond.						3000	915	63.0	28.6
1500A <small>NEW</small>	4-Pair UTP	Polyolefin	.008	0.20	.200	5.08	A-1000	A-305	26.0	11.8
	24 AWG						1000	305	23.0	10.4
	Solid									
	Bare Copper Cond.									

Non-Plenum (NEC CMR and CEC CMR FT4)

Category 5e										
1583R <small>NEW</small>	4-Pair UTP	Polyolefin	.007	0.18	.197	5.00	U-1000	U-305	22.0	10.0
	24 AWG						1000	305	22.0	10.0
	Solid						3000	915	63.0	28.6
	Bare Copper Cond.									
1500R <small>NEW</small>	4-Pair UTP	Polyolefin	.007	0.18	.194	5.00	A-1000	A-305	27.0	12.2
	24 AWG						1000	305	24.0	10.9
	Solid									
	Bare Copper Cond.									
Category 6										
7881A <small>NEW</small>	4-Pair UTP	Polyolefin	.010	0.18	.235	5.97	A-1000	A-305	33.0	15.0
	23 AWG						1000	305	30.0	13.6
	Solid									
	Bare Copper Cond.									

UTP = Unshielded Twisted Pair

Refer to www.belden.com for jacket colors and put-ups.

Color Code Chart

Pair No.	Color Combinations
1	White/Blue Stripe & Blue
2	White/Orange Stripe & Orange
3	White/Green Stripe & Green
4	White/Brown Stripe & Brown



Security UTP Cable

CCTV Fixed and PTZ Applications

Plenum-Rated



Plenum-Rated

CMP FT6 Rated

Product Description

Solid bare copper conductors, unshielded twisted pairs, FEP Teflon® insulation, Flamarrest® jacket with rip cord. Sequential footage marking every two feet.

Specifications

Conductor	Solid Bare Copper
Shield	Unshielded
Jacket	Flamarrest
Approvals	
NEC	CMP
CEC	CMP FT6
NEC Articles	800
Nominal Impedance	100Ω
Temperature Rating	75°C

Applications:

- 100BaseTX
- 100BaseVG ANYLAN
- 155ATM
- 622ATM
- AES/EBU
- Digital Video, RS-422
- Gigabit Ethernet
- NTSC/PAL Component or Composite Video
- Premise Horizontal Cable
- CCTV UTP
- Pan/Tilt/Zoom (PTZ)



Part No.	Component Descriptions	Insulation Material	Insulation Nominal OD		Nominal OD		Standard Lengths		Standard Unit Weight	
			Inch	mm	Inch	mm	Ft.	m	Lbs.	kg

Plenum-Rated (NEC CMP and CEC CMP FT6)

Category 5e

1585A <small>new</small>	4-Pair UTP 24 AWG Solid Bare Copper Cond.	FEP Teflon	.007	0.18	.195	4.95	U-1000 1000 3000	U-305 305 915	23.0 24.0 69.0	10.4 10.9 31.3
------------------------------------	---	------------	------	------	------	------	------------------------	---------------------	----------------------	----------------------

1501A <small>new</small>	4-Pair UTP 24 AWG Solid Bare Copper Cond.	FEP Teflon	.008	0.20	.195	4.95	A-1000 1000	A-305 305	26.0 23.0	11.8 10.4
------------------------------------	---	------------	------	------	------	------	----------------	--------------	--------------	--------------

Category 6

7882A <small>new</small>	4-Pair UTP 23 AWG Solid Bare Copper Cond.	FEP Teflon	.009	0.23	.224	5.69	A-1000 1000	A-305 305	32.0 29.0	14.5 13.2
------------------------------------	---	------------	------	------	------	------	----------------	--------------	--------------	--------------

UTP = Unshielded Twisted Pair

Refer to www.belden.com for jacket colors and put-ups.

Color Code Chart

Pair No.	Color Combinations
1	White/Blue Stripe & Blue
2	White/Orange Stripe & Orange
3	White/Green Stripe & Green
4	White/Brown Stripe & Brown

Teflon is a DuPont trademark.



For more information, contact Belden Technical Support: 1-800-BELDEN-1 • www.belden.com

Pan/Tilt/Zoom Banana Peel® Composite

CCTV plus Audio or Power or Pan and Tilt CCTV Control Applications
Riser-Rated



**Composite Coax,
Pair and Multi-Conductors**
CMR/CMG FT4 Rated

Product Description

(1) Coax: 20 AWG solid bare copper conductor, gas-injected foam high-density polyethylene insulation, bare copper braid shield (95% coverage), Black PVC jacket.

(1) Pair: 23 AWG solid bare copper conductors, polyolefin insulation, Blue PVC jacket. Color code: White/Blue Stripe & Blue. Category 5e tested.

(2) Conductors: 18 AWG stranded (7x26) bare copper conductors, PVC insulation, White flame-retardant PVC jacket. Color code: Black & Red.

Specifications

Conductor	Bare Copper
Application Shielding	
Video	Bare Copper Braid
Control	Unshielded
Power	Unshielded
Component Jackets	PVC
Overall Jacket	None
Approvals	
NEC	CMR
CEC	CMG FT4
NEC Articles	800
Voltage Rating	300V
Temperature Rating	75°C

Applications

- CCTV plus Control and Power
- Pan, Tilt and Zoom CCTV Control

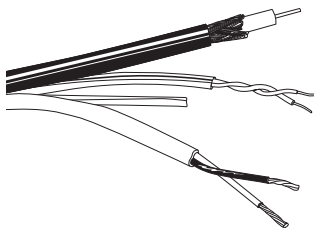

Part No.	Component Descriptions	Insulation Material & Shielding	Component Nom. OD		Overall Nom. OD		Standard Lengths		Standard Unit Weight	
			Inch	mm	Inch	mm	Ft.	m	Lbs.	kg

Composite (NEC CMR and CEC CMG FT4)

RG-59/U 20 AWG Coax • Cat. 5e 23 AWG Pair • 18 AWG Cond.										
500PTZ <small>NEW</small>	(1) Coax:	Gas-injected	.227	5.57	.411	10.4	500	152	38.5	17.5
	RG-59/U	Foam HDPE,					1000	305	71.0	32.3
	20 AWG	Bare Copper								
	(solid)	Braid Shield								
	Bare Copper	(95% coverage)								
	Cond.									
	(1) 1-Pair	Polyolefin,	.118	3.00						
	23 AWG	Unshielded								
	(solid)									
	Bare Copper									
	Cond.									
	(1) 2-Cond.	PVC,	.171	4.34						
	18 AWG	Unshielded								
	Stranded									
	(7x26)									
	Bare Copper									
	Cond.									

HDPE = High-density Polyethylene
U.S. Patent 7,049,523

Individual Cable Jacket Color Coding System

Jacket Color	Cable Type
Black	Coax, RG-59/U, 20 AWG, 95% Braid
Blue	1/P, 23 AWG, Unshielded
White	2/C, 18 AWG, Unshielded

Pan/Tilt/Zoom Banana Peel® Composite

CCTV plus Audio or Power or Pan and Tilt CCTV Control Applications
Plenum-Rated



Composite Coax, Pair and Multi-Conductors

CMP FT6 Rated

Product Description

(1) Coax: 20 AWG solid bare copper conductor, Foam Perfluoroalkoxy (FPFA) insulation, bare copper braid shield (95% coverage), Black Flamarrest® jacket.

(1) Pair: 23 AWG solid bare copper conductors, FEP insulation, Blue Flamarrest jacket. Color code: White/Blue Stripe & Blue. Category 5e tested.

(2) Conductors: 18 AWG stranded (7x26) bare copper conductors, Flamarrest insulation, White Flamarrest jacket. Color code: Black & Red.

Specifications

Conductor	Bare Copper
Application Shielding	
Video	Bare Copper Braid
Control	Unshielded
Power	Unshielded
Component Jackets	Flamarrest
Overall Jacket	None
Approvals	
NEC	CMP
CEC	CMP FT6
NEC Articles	800
Voltage Rating	300V
Temperature Rating	75°C

Applications

- CCTV plus Control and Power
- Pan, Tilt and Zoom CCTV Control

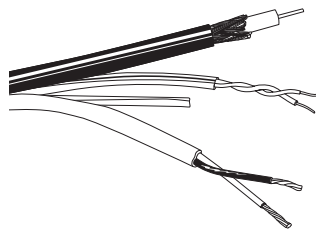

Part No.	Component Descriptions	Insulation Material & Shielding	Component Nom. OD		Overall Nom. OD		Standard Lengths		Standard Unit Weight	
			Inch	mm	Inch	mm	Ft.	m	Lbs.	kg

Plenum-rated Composite (NEC CMP and CEC CMP FT6)

RG-59/U 20 AWG Coax • Cat. 5e 23 AWG Pair • 18 AWG Cond.										
600PTZ <small>NEW</small>	(1) Coax: RG-59/U 20 AWG (solid) Bare Copper Cond.	FPFA, Bare Copper Braid Shield (95% coverage)	.193	4.90	.351	8.9	500	152	38.5	17.5
	(1) 1-Pair 23 AWG (solid) Bare Copper Cond.	FEP, Unshielded	.116	2.95			1000	305	71.0	32.2
	(1) 2-Cond. 18 AWG Stranded (7x26) Bare Copper Cond.	Flamarrest, Unshielded	.158	4.01						

FEP = Fluorinated Ethylene Propylene • FPFA = Foam Perfluoroalkoxy
U.S. Patent 7,049,523

Individual Cable Jacket Color Coding System

Jacket Color	Cable Type
Black	Coax, RG-59/U, 20 AWG, BC Braid (95%)
Blue	1/P, 23 AWG, Unshielded
White	2/C, 18 AWG, Unshielded

Pan/Tilt/Zoom Banana Peel® Composite

CCTV plus Audio or Power or Pan and Tilt CCTV Control Applications
Riser-Rated



Composite Coax, Pair and Multi-Conductors

CMR/CMG FT4 Rated

Product Description

(1) Coax: 20 AWG solid bare copper conductor, gas-injected foam high-density polyethylene insulation, bare copper braid shield (95% coverage), Black PVC jacket.

(1) Pair: 22 AWG stranded (7x30) bare copper conductors, polyolefin insulation, Beldfoil® shield (100% coverage), Blue PVC jacket. Color code: White/Blue Stripe & Blue. Category 5e tested.

(2) Conductors: 18 AWG stranded (7x26) bare copper conductors, PVC insulation, White flame-retardant PVC jacket. Color code: Black & Red.

Specifications

Conductor	Bare Copper
Application Shielding	
Video	Bare Copper Braid
Control	Aluminum/Polyester
Power	Unshielded
Component Jackets	PVC
Overall Jacket	None
Approvals	
NEC	CMR
CEC	CMG FT4
NEC Articles	800
Voltage Rating	300V
Temperature Rating	75°C

Applications

- CCTV plus Control and Power
- Pan, Tilt and Zoom CCTV Control

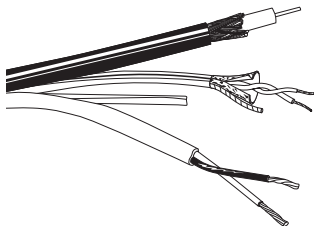

Part No.	Component Descriptions	Insulation Material & Shielding	Component Nom. OD		Overall Nom. OD		Standard Lengths		Standard Unit Weight	
			Inch	mm	Inch	mm	Ft.	m	Lbs.	kg

Composite (NEC CMR and CEC CMG FT4)

RG-59/U 20 AWG Coax • Cat. 5e 22 AWG Pair • 18 AWG Cond.										
501PTZ <small>NEW</small>	(1) Coax: RG-59/U 20 AWG (solid) BC Cond.	Gas-injected Foam HDPE, BC Braid Shield (95% coverage)	.227	5.57	.419	10.6	500	152	41.0	18.6
	(1) 1-Pair 22 AWG (7x30) BC Cond.	Polyolefin, Beldfoil Shield (100% coverage)	.177	4.50			1000	305	76.0	34.5
	(1) 2-Cond. 18 AWG Stranded (7x26) BC Cond.	PVC, Unshielded	.171	4.34						

BC = Bare Copper • HDPE = High-density Polyethylene
U.S. Patent 7,049,523

Individual Cable Jacket Color Coding System

Jacket Color	Cable Type
Black	Coax: RG-59/U, 20 AWG, BC Braid Shield
Blue	1/P, 22 AWG, Beldfoil Shield
White	2/C, 18 AWG, Unshielded

Pan/Tilt/Zoom Banana Peel® Composite

CCTV plus Audio or Power or Pan and Tilt CCTV Control Applications
Plenum-Rated



**Composite Coax,
Pair and Multi-Conductors**
CMP FT6 Rated

Product Description

(1) **Coax:** 20 AWG solid bare copper conductor, Foam Perfluoroalkoxy (FPFA) insulation, bare copper braid shield (95% coverage), Black Flammarrest® jacket.

(1) **Pair:** 22 AWG stranded (7x30) bare copper conductors, FEP insulation, Beldfoil® shield (100% coverage), Blue Flammarrest jacket. Color code: White/Blue Stripe & Blue. Category 5e tested.

(2) **Conductors:** 18 AWG stranded (7x26) bare copper conductors, Flammarrest insulation, White Flammarrest jacket. Color code: Black & Red.

Specifications

Conductor	Bare Copper
Application Shielding	
Video	Bare Copper Braid
Control	Aluminum/Polyester
Power	Unshielded
Component Jackets	Flammarrest
Overall Jacket	None
Approvals	
NEC	CMP
CEC	CMP FT6
NEC Articles	800
Voltage Rating	300V
Temperature Rating	75°C

Applications

- CCTV plus Control and Power
- Pan, Tilt and Zoom CCTV Control

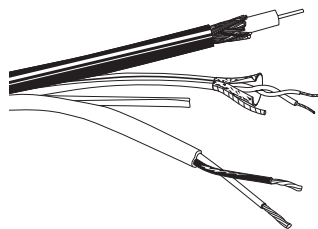

Part No.	Component Descriptions	Insulation Material & Shielding	Component Nom. OD		Overall Nom. OD		Standard Lengths		Standard Unit Weight	
			Inch	mm	Inch	mm	Ft.	m	Lbs.	kg

Plenum-rated Composite (NEC CMP and CEC CMP FT6)

RG-59/U 20 AWG Coax • Cat. 5e 22 AWG Pair • 18 AWG Cond.										
601PTZ <small>NEW</small>	(1) Coax: RG-59/U 20 AWG (solid) BC Cond.	FPFA, BC Braid Shield (95% coverage)	.193	4.90	.351	8.9	500	152	40.0	18.2
	(1) 1-Pair 22 AWG (7x30) BC Cond.	FEP, Beldfoil Shield (100% coverage)	.116	2.95			1000	305	73.0	33.2
	(1) 2-Cond. 18 AWG Stranded (7x26) BC Cond.	Flammarrest, Unshielded	.158	4.01						

BC = Bare Copper • FEP = Fluorinated Ethylene Propylene • FPFA = Foam Perfluoroalkoxy
U.S. Patent 7,049,523

Individual Cable Jacket Color Coding System

Jacket Color	Cable Type
Black	Coax: RG-59/U, 20 AWG, BC Braid Shield
Blue	1/P, 22 AWG, Beldfoil Shield
White	2/C, 18 AWG, Unshielded

Pan/Tilt/Zoom Banana Peel® Composite

CCTV plus Audio or Power or Pan and Tilt CCTV Control Applications
Riser-Rated



**Composite Coax,
Pair and Multi-Conductors**
CMR/CMG FT4 Rated

Product Description

(1) Coax: 20 AWG solid bare copper conductor, gas-injected foam high-density polyethylene insulation, bare copper braid shield (95% coverage), Black PVC jacket.

(1) Pair: 18 AWG stranded (19x30) bare copper conductors, polyolefin insulation, Beldfoil® shield (100% coverage), Blue PVC jacket. Color code: White/Blue Stripe & Blue. Category 5e tested.

(2) Conductors: 18 AWG stranded (7x26) bare copper conductors, PVC insulation, White flame-retardant PVC jacket. Color code: Black & Red.

Specifications

Conductor	Bare Copper
Application Shielding	
Video	Bare Copper Braid
Control	Aluminum/Polyester
Power	Unshielded
Component Jackets	PVC
Overall Jacket	None
Approvals	
NEC	CMR
CEC	CMG FT4
NEC Articles	800
Voltage Rating	300V
Temperature Rating	75°C

Applications

- CCTV plus Control and Power
- Pan, Tilt and Zoom CCTV Control

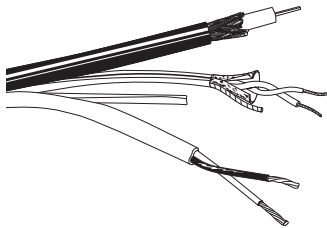

Part No.	Component Descriptions	Insulation Material & Shielding	Component Nom. OD		Overall Nom. OD		Standard Lengths		Standard Unit Weight	
			Inch	mm	Inch	mm	Ft.	m	Lbs.	kg

Composite (NEC CMR and CEC CMG FT4)

RG-59/U 20 AWG Coax • Cat. 5e 18 AWG Pair • 18 AWG Cond.										
502PTZ <small>NEW</small>	(1) Coax: RG-59/U 20 AWG (solid) BC Cond.	Gas-injected Foam HDPE, BC Braid Shield (95% coverage)	.227	5.57	.451	11.5	500	152	50.0	22.7
	(1) 1-Pair 18 AWG (19x30) BC Cond.	Polyolefin, Beldfoil Shield (100% coverage)	.219	5.56			1000	305	94.0	42.6
	(1) 2-Cond. 18 AWG Stranded (7x26) BC Cond.	PVC, Unshielded	.171	4.34						

BC = Bare Copper • HDPE = High-density Polyethylene
U.S. Patent 7,049,523

Individual Cable Jacket Color Coding System

Jacket Color	Cable Type
Black	Coax: RG-59/U, 20 AWG, BC Braid Shield
Blue	1/P, 18 AWG, Beldfoil Shield
White	2/C, 18 AWG, Unshielded

Pan/Tilt/Zoom Banana Peel® Composite

CCTV plus Audio or Power or Pan and Tilt CCTV Control Applications
Plenum-Rated



**Composite Coax,
Pair and Multi-Conductors**
CMP FT6 Rated

Product Description

(1) Coax: 20 AWG solid bare copper conductors, Foam Perfluoroalkoxy (FPFA) insulation, bare copper braid shield (95% coverage), Black Flamarrest® jacket.

(1) Pair: 18 AWG stranded (19x30) bare copper conductor, FEP insulation, Beldfoil® shield (100% coverage), Blue Flamarrest jacket. Color code: White/Blue Stripe & Blue. Category 5e tested.

(2) Conductors: 18 AWG stranded (7x26) bare copper conductors, Flamarrest insulation, White Flamarrest jacket. Color code: Black & Red.

Specifications

Conductor	Bare Copper
Application Shielding	Video: Bare Copper Braid Control: Aluminum/Polyester Power: Unshielded
Component Jackets	Flamarrest
Overall Jacket	None
Approvals	NEC: CMP CEC: CMP FT6
NEC Articles	800
Voltage Rating	300V
Temperature Rating	75°C

Applications

- CCTV plus Control and Power
- Pan, Tilt and Zoom CCTV Control

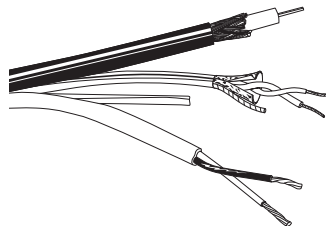

Part No.	Component Descriptions	Insulation Material & Shielding	Component Nom. OD		Overall Nom. OD		Standard Lengths		Standard Unit Weight	
			Inch	mm	Inch	mm	Ft.	m	Lbs.	kg

Plenum-rated Composite (NEC CMP and CEC CMP FT6)

RG-59/U 20 AWG Coax • Cat. 5e 18 AWG Pair • 18 AWG Cond.										
602PTZ <small>NEW</small>	(1) Coax: RG-59/U 20 AWG (solid) BC Cond.	FPFA, BC Braid Shield (95% coverage)	.193	4.90	.363	9.2	500	152	42.5	19.3
	(1) 1-Pair 18 AWG (19x30) BC Cond.	FEP, Beldfoil Shield (100% coverage)	.150	3.81			1000	305	79.0	35.8
	(1) 2-Cond. 18 AWG Stranded (7x26) BC Cond.	Flamarrest, Unshielded	.158	4.01						

BC = Bare Copper • FEP = Fluorinated Ethylene Propylene • FPFA = Foam Perfluoroalkoxy

Individual Cable Jacket Color Coding System

Jacket Color	Cable Type
Black	Coax: RG-59/U, 20 AWG, BC Braid Shield
Blue	1/P, 18 AWG, Beldfoil Shield
White	2/C, 18 AWG, Unshielded

US Patent 7,049,523



For more information, contact Belden Technical Support: 1-800-BELDEN-1 • www.belden.com

Security Coaxial Cable

CATV and MATV Applications
Commercial or Schlage Systems



Commercial and Schlage Coax

CM FT1 Rated

Product Description

Bare copper conductor, foam polyolefin insulation, foil plus braid shield(s) as indicated, Black PVC jacket. Sequential footage marking every two feet.

Specifications

Conductor	Bare Copper
Insulation	FPO
Shield	
Coax	Duofoil® + Aluminum Braid(s)
Schlage	Duobond® + Aluminum Braid(s)
Jacket	PVC
Approvals	
NEC	CM
CEC	CM FT1
NEC Articles	820
Nominal Impedance	75Ω
Temperature Rating	75°C

Applications

- CATV
- MATV

Duofoil Shield

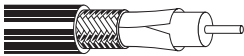

Duobond Shield (Schlage Systems)



Quad Shield



Part No.	AWG	Stranding and Conductor	Shield/Braid Coverage	Insulation Nominal OD		Nominal OD		Standard Lengths		Standard Unit Weight	
				Inch	mm	Inch	mm	Ft.	m	Lbs.	kg

Coax (NEC CM and CEC CM FT1)

Series 6 • RG-6 Type											
5339B5*	18	solid BC	Duofoil + 60% AL braid	.180	4.57	.266	6.76	U-500	U-152	17.5	7.9
								500	152	15.5	7.0
								U-1000	U-305	34.0	15.4
								1000	305	35.0	15.9
5339Q5*	18	solid BC	Quad**	.180	4.57	.298	7.57	U-500	U-152	19.0	8.6
								U-1000	U-305	36.0	16.3
								1000	305	36.0	16.3

Schlage Coax (NEC CM and CEC CM FT1)

Series 6 • RG-6 Type											
5399B5	18	solid BC	Duobond + 60% AL braid	.180	4.50	.270	6.86	U-1000	U-305	28.0	12.7
								1000	305	29.0	13.2

AL = Aluminum • BC = Bare Copper

* Also available in White.

** Quad Shield = Duofoil tape + 60% aluminum braid + Duofoil tape + 40% aluminum braid.

Security Coaxial Cable

Commercial CATV or MATV Applications
Plenum-Rated



Plenum-Rated Coax

CMP FT6 Rated

Product Description

Solid bare copper conductor. Foam FEP insulation. Foil plus aluminum braid shield(s) as indicated. Natural Flamarrest® jacket (except 6139B8 which is White fluorocopolymer). Sequential footage marking every two feet.

Specifications

Conductor	Solid BC or BCCC
Insulation	Foam FEP
Shield	Duofoil® + Aluminum Braid(s)
Jacket	Flamarrest†
Approvals	
NEC	CMP
CEC	CMP FT6
NEC Articles	820
Nominal Impedance	75Ω
Temperature Rating	75°C

†6139B8 jacket is White fluorocopolymer.

Applications

- CATV
- MATV

Duofoil + Braid Shield

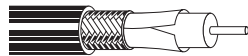

Quad Shield



Part No.	AWG	Stranding and Conductor	Shield/Braid Coverage	Insulation Nominal OD		Nominal OD		Standard Lengths		Standard Unit Weight	
				Inch	mm	Inch	mm	Ft.	m	Lbs.	kg

Plenum-Rated Coax (NEC CMP and CEC CMP FT6)

Series 59 • RG-59 Type

6439C8	20	solid BC	Duofoil + 80% AL braid	.135	3.43	.199	5.05	1000	305	20.0	9.1
6439Q8	20	solid BC	Quad*	.135	3.43	.223	5.66	U-1000	U-305	24.0	10.9

Series 6 • RG-6 Type

633938	18	solid BC	Duofoil + 90% AL braid	.170	4.32	.233	5.92	U-500 500 1000	U-152 152 305	15.0 15.0 29.0	6.8 6.8 13.2
6339Q8	18	solid BCCC	Quad*	.170	4.32	.248	6.30	U-1000 1000	U-305 305	30.0 32.0	13.6 14.5

Series 11 • RG-11 Type

6139B8	14	solid BC	Duofoil + 60% AL braid	.274	6.96	.348	8.84	1000	305	66.0	30.0
---------------	----	----------	------------------------	------	------	------	------	------	-----	------	------

AL = Aluminum • BC = Bare Copper • BCCC = Bare Copper Center Conductor

*Quad Shield: Duofoil tape + 60% copper braid + Duofoil tape + 40% copper braid.

Security Coaxial Cable

Surveillance and CCTV Applications
Limited Combustible



Limited Combustible Coax

FHC 25/50 CMP

Product Description

Bare copper conductor, foam FEP insulation, bare copper braid shield (95% coverage). Black FEP jacket. Sequential footage marking every two feet.

Specifications

Conductor	Bare Copper
Insulation	FFEP
Shield	Bare Copper Braid
Jacket	FEP
Approvals	CMP FHC 25/50
NEC	
NEC Articles	800
Nominal Impedance	75Ω
Temperature Rating	200°C

Applications

- CCTV
- Video Security Coax

Solid Conductor

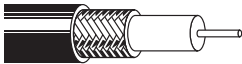

Part No.	AWG	Stranding and Conductor	Shield/Braid Coverage	Insulation Nominal OD		Nominal OD		Standard Lengths		Standard Unit Weight	
				Inch	mm	Inch	mm	Ft.	m	Lbs.	kg

Limited Combustible Coax (CMP FHC 25/50)

RG-59/U Type											
7986LC	20	solid	95%	.135	3.43	.193	4.90	500	152	17.0	7.7
<small>NEW</small>		BC	BC					1000	305	31.0	14.1
RG-6/U Type											
7985LC	18	solid	95%	.170	4.31	.228	5.79	500	152	22.0	10.0
<small>NEW</small>		BC	BC					1000	305	44.0	20.0

BC = Bare Copper • FEP = Fluorinated Ethylene Propylene

UTP CCTV Surveillance Cables

CCTV and PTZ Applications
Unshielded, Riser-Rated



Composite Unshielded Multi-conductor CMR/CMG FT4 Rated

Product Description

Data Pair: 24 or 23 AWG solid bare copper conductors, unshielded twisted pairs, polyolefin insulation.

Power Conductors: 16 AWG stranded (19x29) tinned copper conductors, unshielded, polypropylene insulation.

Overall: White or Black, flame-retardant PVC jacket.

Specifications

Conductor	
Data Pair	Solid Bare Copper
Power	Stranded Tinned Copper
Shield	Unshielded
Jacket	F-R PVC
Approvals	
NEC	CMR
CEC	CMG FT4
NEC Articles	800
Nominal Impedance	100Ω
Temperature Rating	75°C

Applications:

- UTP-CCTV
- CCTV
- CCTV on UTP
- CCTV Video/Control
- Closed Circuit Television
- Pan/Tilt/Zoom (PTZ) Cameras
- Surveillance
- Video Over Twisted Pairs

5284UE (Round Construction)

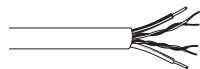

5284US (Siamese Construction)

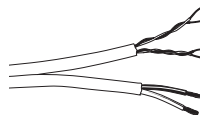

5288US (Siamese Construction)

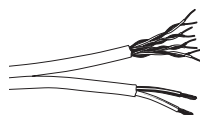

Part No.	Component Descriptions	Insulation Material	Insulation Nominal OD		Nominal OD		Standard Lengths		Standard Unit Weight	
			Inch	mm	Inch	mm	Ft.	m	Lbs.	kg

Unshielded Composite (NEC CMR and CEC CMG FT4)

Category 5e										
5284UE <small>NEW</small>	2-Pair UTP	Polyolefin	.040	1.01	.233	5.92	500	152	22.5	10.2
	23 AWG Solid Bare Copper Cond.									
	2-Cond. 16 AWG Stranded (19x29) Tinned Copper Cond.	Polypropylene	.077	1.96						
5284US <small>NEW</small>	2-Pair UTP	Polyolefin	.035	.89	.208	5.28	500	152	25.5	11.6
	24 AWG Solid Bare Copper Cond.									
	2-Cond. 16 AWG Stranded (19x29) Tinned Copper Cond.	PVC	.080	2.03						
5288US* <small>NEW</small>	4-Pair UTP	Polyolefin	.035	.89	.198	5.03	500	152	27.5	12.5
	24 AWG Solid Bare Copper Cond.									
	2-Cond. 16 AWG Stranded (19x29) Tinned Copper Cond.	PVC	.080	2.03						

UTP = Unshielded Twisted Pair • F-R = Flame-retardant

*Special Construction available upon request.

Color Code Chart (Data Pair)

Pair No.	Color
1	Blue & White/Blue Stripe
2	Orange & White/Orange Stripe
3	Green & White/Green Stripe
4	Brown & White/Brown Stripe

Color Code Chart (Power)

Cond. No.	Color
1	Black
2	Red

UTP CCTV Surveillance Cables

CCTV and PTZ Applications
Unshielded, Plenum-Rated



Composite
Unshielded Multi-conductor
CMP Rated

Product Description

Data Pair: 24 or 23 AWG solid bare copper conductors, unshielded twisted pairs, FEP insulation.

Power Conductors: 16 AWG stranded (19x29) tinned copper conductors, unshielded, FEP or Flammarrest® insulation.

Overall: White or Black, Flammarrest jacket.

Specifications

Conductor	
Data Pair	Solid Bare Copper
Power	Stranded Tinned Copper
Shield	Unshielded
Jacket	Flammarrest
Approvals	
NEC	CMP
CEC	CMP
NEC Articles	800
Nominal Impedance	100Ω
Temperature Rating	75°C

Applications:

- UTP-CCTV
- CCTV
- CCTV on UTP
- CCTV Video/Control
- Closed Circuit Television
- Pan/Tilt/Zoom (PTZ) Cameras
- Surveillance
- Video Over Twisted Pairs

6284UE (Round Construction)

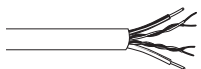

6284US (Siamese Construction)

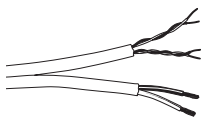

6288US (Siamese Construction)

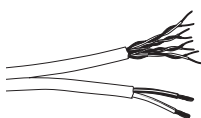

Part No.	Component Descriptions	Insulation Material	Insulation Nominal OD		Nominal OD		Standard Lengths		Standard Unit Weight	
			Inch	mm	Inch	mm	Ft.	m	Lbs.	kg

Unshielded Composite (NEC CMP and CEC CMP)

Category 5e										
6284UE <small>NEW</small>	2-Pair UTP	FEP	.041	1.04	.220	5.59	500	152	19.5	8.8
	23 AWG Solid Bare Copper Cond.									
	2-Cond. 16 AWG Stranded (19x29) Tinned Copper Cond.	FEP	.077	1.96						
6284US <small>NEW</small>	2-Pair UTP	FEP	.035	.89	.173	4.39	500	152	26.0	11.8
	24 AWG Solid Bare Copper Cond.									
	2-Cond. 16 AWG Stranded (19x29) Tinned Copper Cond.	Flammarrest	.077	1.96						
6288US <small>NEW</small>	4-Pair UTP	FEP	.042	1.07	.222	5.64	500	152	34.5	15.7
	23 AWG Solid Bare Copper Cond.									
	2-Cond. 16 AWG Stranded (19x29) Tinned Copper Cond.	Flammarrest	.077	1.96						

FEP = Fluorinated Ethylene Propylene • UTP = Unshielded Twisted Pair

Color Code Chart (Data Pair)

Pair No.	Color
1	Blue & White/Blue Stripe
2	Orange & White/Orange Stripe
3	Green & White/Green Stripe
4	Brown & White/Brown Stripe

Color Code Chart (Power)

Cond. No.	Color
1	Black
2	Red

UTP CCTV Surveillance Cables

CCTV Fixed and PTZ Applications
Unshielded, Non-Plenum



Unshielded Twisted Pairs

CM FT1 or CMR Rated

Product Description

Solid bare copper conductors, unshielded twisted pairs, polyolefin insulation, PVC jacket with rip cord. Sequential footage marking every two feet.

Specifications

Conductor	Solid Bare Copper
Shield	Unshielded
Jacket	PVC
Approvals	CM or CMR
NEC	CEC
	CM FT1 or CMR FT4
Nominal Impedance	100Ω
Temperature Rating	80°C

Applications:

- 100BaseTX
- 100BaseVG ANYLAN
- 155ATM
- 622ATM
- AES/EBU
- Digital Video, RS-422
- Gigabit Ethernet
- NTSC/PAL Component or Composite Video
- Premise Horizontal Cable
- CCTV UTP
- PTZ
- Pan/Tilt/Zoom

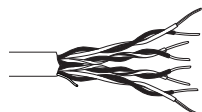

Color Code Chart

Pair No.	Color Combinations
1	White/Blue Stripe & Blue
2	White/Orange Stripe & Orange
3	White/Green Stripe & Green
4	White/Brown Stripe & Brown

Part No.	Component Descriptions	Insulation Material	Insulation Nominal OD		Nominal OD		Standard Lengths		Standard Unit Weight	
			Inch	mm	Inch	mm	Ft.	m	Lbs.	kg

Unshielded Twisted Pairs (NEC CM and CEC CM FT1)

Category 5e										
1583A <small>NEW</small>	4-Pair UTP	Polyolefin	.008	0.20	.195	4.95	U-1000	U-305	21.0	9.5
	24 AWG						1000	305	21.0	9.5
	Solid						1640	500	34.4	15.7
	Bare Copper Cond.						3000	915	63.0	28.6
1500A <small>NEW</small>	4-Pair UTP	Polyolefin	.008	0.20	.200	5.08	A-1000	A-305	26.0	11.8
	24 AWG						1000	305	23.0	10.4
	Solid									
	Bare Copper Cond.									

Unshielded Twisted Pairs (NEC CMR and CEC CMR FT4)

Category 5e										
1583R <small>NEW</small>	4-Pair UTP	Polyolefin	.007	0.18	.197	5.00	U-1000	U-305	23.0	10.4
	24 AWG						1000	305	22.0	10.0
	Solid						3000	915	63.0	28.6
	Bare Copper Cond.									
1500R <small>NEW</small>	4-Pair UTP	Polyolefin	.007	0.18	.194	5.00	A-1000	A-305	27.0	12.2
	24 AWG						1000	305	24.0	10.9
	Solid									
	Bare Copper Cond.									
Category 6										
7881A <small>NEW</small>	4-Pair UTP	Polyolefin	.010	0.18	.235	5.97	A-1000	A-305	33.0	15.0
	23 AWG						1000	305	30.0	13.6
	Solid									
	Bare Copper Cond.									

UTP = Unshielded Twisted Pair

Refer to www.belden.com for jacket colors and put-ups.

UTP CCTV Surveillance Cables

CCTV Fixed and PTZ Applications
Unshielded, Plenum-Rated



Unshielded Twisted Pairs

CMP FT6 Rated

Product Description

Solid bare copper conductors, unshielded twisted pairs, FEP Teflon® insulation, Flamarrest® jacket with rip cord. Sequential footage marking every two feet.

Specifications

Conductor	Solid Bare Copper
Shield	Unshielded
Jacket	Flamarrest
Approvals	
NEC	CMP
CEC	CMP FT6
NEC Articles	800
Nominal Impedance	100Ω
Temperature Rating	75°C

Applications:

- 100BaseTX
- 100BaseVG ANYLAN
- 155ATM
- 622ATM
- AES/EBU
- Digital Video, RS-422
- Gigabit Ethernet
- NTSC/PAL Component or Composite Video
- Premise Horizontal Cable
- CCTV UTP
- Pan/Tilt/Zoom (PTZ)



Part No.	Component Descriptions	Insulation Material	Insulation Nominal OD		Nominal OD		Standard Lengths		Standard Unit Weight	
			Inch	mm	Inch	mm	Ft.	m	Lbs.	kg

Unshielded Twisted Pairs (NEC CMP and CEC CMP FT6)

Category 5e										
1585A <small>new</small>	4-Pair UTP 24 AWG Solid Bare Copper Cond.	FEP Teflon®	.007	0.18	.195	4.95	U-1000 1000 3000	U-305 305 915	23.0 24.0 69.0	10.4 10.9 31.3
1501A <small>new</small>	4-Pair UTP 24 AWG Solid Bare Copper Cond.	FEP Teflon	.008	0.20	.195	4.95	A-1000 1000	A-305 305	27.0 24.0	12.2 10.9
Category 6										
7882A <small>new</small>	4-Pair UTP 23 AWG Solid Bare Copper Cond.	FEP Teflon	.009	0.23	.224	5.69	A-1000 1000	A-305 305	34.0 31.0	15.4 14.1

UTP = Unshielded Twisted Pair

Refer to www.belden.com for jacket colors and put-ups.

Color Code Chart

Pair No.	Color Combinations
1	White/Blue Stripe & Blue
2	White/Orange Stripe & Orange
3	White/Green Stripe & Green
4	White/Brown Stripe & Brown

Teflon is a DuPont trademark.



Fire Alarm Cable

Commercial Applications
Unshielded, Power-Limited



Unshielded Multi-conductor

FPLR/CMG FT4 Rated

Product Description

Bare copper conductors, PVC insulation, conductors cabled together, Red PVC jacket with rip cord. Sequential footage marking every two feet.

Color Code: See chart below.

Specifications

Conductor	Bare Copper
Insulation	PVC
Jacket	PVC
Jacket Thickness	.015" (.381mm)
Approvals	
NEC	FPLR
CEC (22–16 AWG only)	CMG FT4
California State Fire Marshall	
NEC Articles	760
Voltage Rating	300V
Temperature Rating	75°C

Applications

- Fire Protection
- Alarm
- Signal
- Monitor/Detection
- Audio Circuits
- Control Circuits
- Initiating Circuits
- Notification Circuits



Color Code Chart

Cond. No.	Color
1	Black
2	Red
3	Brown
4	Blue
5	Orange
6	Yellow
7	Purple
8	Green
9	Red/Black
10	Red/White
11	Red/Green
12	Red/Blue

Part No.	No. of Cond.	Stranding	Standard Lengths		Standard Unit Weight		Insulation Thickness		Nominal OD	
			Ft.	m	Lbs.	kg	Inch	mm	Inch	mm

Unshielded Multi-conductor (NEC FPLR and CEC CMG FT4)

22 AWG										
5522UL	4	solid	C-500	C-152	7.0	3.2	.010	.25	.125	3.18
			U-1000	U-305	16.0	7.3				
			1000	305	16.0	7.3				
5524UL										
5524UL	6	solid	C-500	C-152	10.0	4.6	.010	.25	.168	4.27
			U-1000	U-305	21.0	9.5				
18 AWG										
5320UL	2	solid	C-500	C-152	8.0	3.6	.010	.25	.151	3.84
			U-500	U-152	9.0	4.1				
			500	152	9.0	4.1				
5322UL	4	solid	C-250	C-76	7.0	3.2	.010	.25	.176	4.47
			C-500	C-152	14.0	6.0				
			U-500	U-152	15.5	7.0				
5324UL	6	solid	U-1000	U-305	18.0	8.2				
			1000	305	17.0	7.7				
5326UL	8	solid	1000	305	61.0	27.7	.010	.25	.230	5.84
5328UL	10	solid	1000	305	71.0	32.3	.010	.25	.272	6.91
5329UL	12	solid	1000	305	83.0	37.7	.010	.25	.281	7.14
16 AWG										
5220UL*	2	solid	500	152	13.0	5.9	.010	.25	.174	4.42
			U-1000	U-305	24.0	10.9				
			1000	305	25.0	11.4				
5222UL	4	solid	1000	305	45.0	20.4	.010	.25	.204	5.18
14 AWG										
5120UL*	2	solid	500	152	19.0	8.6	.013	.33	.213	5.41
			1000	305	38.0	17.3				
5122UL	4	solid	1000	305	70.0	31.8	.013	.33	.251	6.38
12 AWG										
5020UL	2	solid	1000	305	55.0	25.0	.013	.33	.247	6.27

*Also available in other jacket colors. Consult www.belden.com.

20 • New Generation® Cables

Fire Alarm Cable

Commercial Applications
Shielded, Power-Limited



Shielded Multi-conductor

FPLR/CMG FT4 Rated

Product Description

Bare copper conductors, PVC insulation, conductors cabled together, Beldfoil® shield and drain wire, Red PVC jacket with rip cord. Sequential footage marking every two feet.

Color Code: See chart below.

Specifications

Conductor	Bare Copper
Insulation	PVC
Shield	Beldfoil
Jacket	PVC
Jacket Thickness	.015" (.381mm)
Approvals	
NEC	FPLR
CEC (22–16 AWG only)	CMG FT4
California State Fire Marshall	
NEC Articles	760
Voltage Rating	300V
Temperature Rating	75°C

Applications

- Fire Protection
- Alarm
- Signal
- Monitor/Detection
- Audio Circuits
- Control Circuits
- Initiating Circuits
- Notification Circuits

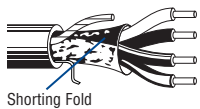

Color Code Chart

Cond. No.	Color
1	Black
2	Red
3	Brown
4	Blue

Part No.	No. of Cond.	Stranding	Standard Lengths		Standard Unit Weight		Insulation Thickness		Nominal OD	
			Ft.	m	Lbs.	kg	Inch	mm	Inch	mm

Shielded Multi-conductor (NEC FPLR and CEC CMG FT4)

22 AWG										
5522FL	4	solid	C-500	C-152	9.0	4.1	.010	.25	.145	3.68
			U-1000	U-305	19.0	8.6				
			1000	305	19.0	8.6				
18 AWG										
5320FL*	2	solid	C-500	C-152	10.5	4.8	.010	.25	.155	3.94
			U-500	U-152	11.5	5.2				
			500	152	11.5	5.2				
			U-1000	U-305	22.0	10.0				
			1000	305	22.0	10.0				
5322FL	4	solid	C-500	C-152	15.5	7.0	.010	.25	.170	4.32
			500	152	16.5	7.5				
			U-1000	U-305	32.0	14.5				
			1000	305	34.0	15.4				
16 AWG										
5220FL*	2	solid	1000	305	29.0	13.2	.010	.25	.178	4.52
5222FL	4	solid	1000	305	50.0	22.7	.010	.25	.208	5.28
14 AWG										
5120FL*	2	solid	500	152	22.0	10.0	.013	.33	.217	5.51
			1000	305	43.0	19.5				
5122FL	4	solid	1000	305	79.0	35.9	.013	.33	.255	6.48
12 AWG										
5020FL	2	solid	1000	305	60.0	27.2	.013	.33	.251	6.38

*Also available in other jacket colors. Consult www.belden.com.

Fire Alarm Cable

Commercial Applications, Addressable Systems
Unshielded or Shielded, Power-Limited, Mid-Capacitance



Unshielded Multi-conductor

FPL Rated

Product Description

Bare copper conductors, foam high-density polyethylene insulation, cabled together, Red PVC jacket with rip cord. Sequential footage marking every two feet.

Color Code: Black, Red.

Shielded Multi-conductor

FPL Rated

Product Description

Bare copper conductors, foam high-density polyethylene insulation, cabled together, Beldfoil® shield tape (foil side out), Red PVC jacket with rip cord. Sequential footage marking every two feet.

Color Code: See chart below.

Specifications

Conductor	Bare Copper
Insulation	FHDPE
Shield (where applicable)	Beldfoil
Jacket	PVC
Jacket Thickness	.033" (.838mm)
Approvals	
NEC	FPL
California State Fire Marshall	
NEC Articles	760
Voltage Rating	300V
Temperature Rating	75°C
Nominal Capacitance*	
Unshielded†	13 pF/ft.
Shielded††	20–36 pF/ft.

*Capacitance between conductors.

†60% lower capacitance than cables on page 20.55

††60% lower capacitance than cables on page 20.56

Applications

- Addressable Fire Systems
- Data Circuits
- Audio Circuits
- Control Circuits
- Initiating Circuits
- Notification Circuits

Color Code Chart

Cond. No.	Color
1	Black
2	Red
3	Brown
4	Blue

Part No.	No. of Cond.	Stranding	Standard Lengths		Standard Unit Weight		Insulation Thickness		Nominal OD	
			Ft.	m	Lbs.	kg	Inch	mm	Inch	mm

Unshielded Multi-conductor (NEC FPL)

18 AWG										
5320UJ	2	solid	U-1000	U-305	22.0	10.0	.015	.38	.206	5.23
16 AWG										
5220UJ	2	solid	500	152	16.0	7.3	.015	.38	.230	5.84
			1000	305	32.0	14.5				

Shielded Multi-conductor (NEC FPL)

18 AWG										
5320FJ	2	solid	U-1000	U-305	27.0	12.3	.015	.38	.211	5.36
			1000	305	28.0	12.7				
5322FJ	4	solid	1000	305	43.0	19.5	.015	.38	.240	6.10
16 AWG										
5220FJ	2	solid	500	152	18.0	8.2	.015	.38	.235	5.97
			U-1000	U-305	35.0	15.9				
			1000	305	37.0	16.8				
5222FJ	4	solid	1000	305	59.0	26.8	.015	.38	.269	6.83
14 AWG										
5120FJ	2	solid	1000	305	49.0	22.3	.020	.51	.279	7.09
12 AWG										
5020FJ	2	solid	1000	305	69.0	31.3	.020	.51	.317	8.05

Unshielded



Shielded

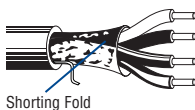

Fire Alarm Cable

NPLF Systems

Unshielded or Shielded, Non-Power-Limited Signaling Cable



Unshielded Multi-conductor

NPLF Rated
150V Max. Per NEC Article 760
Indoor (Non-conduit per NEC)

Product Description

Bare copper conductors, PVC/Nylon insulation, cabled together, Red PVC jacket with rip cord. Sequential footage marking every two feet.

Color Code: See chart below.

Shielded Multi-conductor

NPLF Rated
150V Max. Per NEC Article 760
Indoor (Non-conduit per NEC)

Product Description

Bare copper conductors, PVC/Nylon insulation, cabled together, Beldfoil® shield tape (aluminum side out) plus drain wire, Red PVC jacket with rip cord. Sequential footage marking every two feet.

Color Code: See chart below.

Specifications

Conductor	Bare Copper
Insulation	PVC/Nylon
Insulation Thickness	.021" (.533mm)
Shield (where applicable)	Beldfoil
Jacket	PVC
Approvals	
NEC	NPLF
NEC Articles	760
Voltage Rating	150V
Temperature Rating	75°C

Applications

- Fire Alarm
- Audio Circuits
- Control Circuits
- Initiating Circuits
- Notification Circuits

Color Code Chart

Cond. No.	Color
1	Black
2	Red
3	Brown
4	Blue

Part No.	No. of Cond.	Stranding	Standard Lengths		Standard Unit Weight		Outer Jacket Thickness		Nominal OD	
			Ft.	m	Lbs.	kg	Inch	mm	Inch	mm

Unshielded Multi-conductor (NEC NPLF)

18 AWG										
5320UN	2	solid	500	152	14.0	6.4	.037	.94	.239	6.07
			1000	305	31.0	14.1				
5322UN	4	solid	500	152	28.0	12.7	.042	1.07	.283	7.19
			1000	305	53.0	24.0				
16 AWG										
5220UN	2	solid	500	152	22.0	10.0	.037	.94	.262	6.65
			1000	305	40.0	18.1				
5222UN	4	solid	1000	305	71.0	32.3	.042	1.07	.311	7.90
14 AWG										
5120UN	2	solid	500	152	28.5	13.0	.042	1.07	.299	7.59
			1000	305	53.0	24.1				

Shielded Multi-conductor (NEC NPLF)

18 AWG										
5320FN	2	solid	500	152	15.5	7.0	.037	.94	.243	6.17
			1000	305	35.0	15.9				
5322FN	4	solid	500	152	31.0	14.1	.042	1.07	.287	7.29
			1000	305	57.0	25.9				
16 AWG										
5220FN	2	solid	500	152	23.5	10.7	.037	.94	.266	6.76
			1000	305	45.0	20.5				
5222FN	4	solid	1000	305	76.0	34.5	.042	1.07	.315	8.00
14 AWG										
5120FN	2	solid	500	152	32.0	14.5	.042	1.07	.303	7.70
			1000	305	61.0	27.7				
5122FN	4	solid	500	152	50.5	23.0	.042	1.07	.348	8.84
			1000	305	102.0	46.4				
12 AWG										
5020FN	2	solid	500	152	43.0	19.5	.042	1.07	.337	8.56
			1000	305	83.0	37.7				

Unshielded



Shielded



Shorting Fold

Fire Alarm Cable

Commercial Applications

Unshielded or Shielded, Plenum-Rated, Power-Limited



Unshielded or Shielded Multi-conductor FPLP Rated

Product Description

Bare copper conductors, Flamarrest® insulation, cabled together, Red Flamarrest jacket with rip cord. Shielded version has overall Beldfoil® shield tape (foil side out) and drain wire. Sequential footage marking every two feet.

Color Code: See chart below.

Specifications

Conductor	Bare Copper
Insulation	Flamarrest
Shield (where applicable)	Beldfoil
Jacket	Flamarrest
Jacket Thickness	.015" (.381mm)
Approvals	FPLP
NEC	
California State Fire Marshall	
NEC Articles	760
Voltage Rating	300V
Temperature Rating	75°C

Applications

- Fire Protection
- Alarm
- Signal
- Monitor/Detection
- Audio Circuits
- Control Circuits
- Initiating Circuits
- Notification Circuits

Unshielded



Shielded



Shorting Fold

Color Code Chart

Cond. No.	Color	Cond. No.	Color
1	Black	6	Yellow
2	Red	7	Purple
3	Brown	8	Green
4	Blue	9	Red/Black
5	Orange	10	Red/White

Part No.	No. of Cond.	Stranding	Standard Lengths		Standard Unit Weight		Insulation Thickness		Nominal OD	
			Ft.	m	Lbs.	kg	Inch	mm	Inch	mm

Unshielded Multi-conductor (NEC FPLP)

22 AWG										
6522UL	4	solid	U-1000 1000	U-305 305	17.0 16.0	7.7 7.3	.009	.23	.136	3.45
6524UL	6	solid	C-500 U-1000 1000	C-152 U-305 305	10.5 22.0 22.0	4.8 10.0 10.0	.009	.23	.162	4.12
18 AWG										
6320UL*	2	solid	C-500 U-500 U-1000 1000	C-152 U-152 U-305 305	8.0 9.0 18.0 17.0	3.6 4.1 8.2 7.7	.010	.25	.151	3.84
6321UL	3	solid	1000	305	28.0	12.7	.010	.25	.160	4.06
6322UL	4	solid	C-250 C-500 1000	C-76 C-152 305	7.2 14.5 31.0	3.3 6.6 14.1	.010	.25	.183	4.64
6324UL	6	solid	U-1000 1000	U-305 305	44.0 46.0	20.0 20.9	.010	.25	.211	5.36
6326UL	8	solid	1000	305	63.0	28.6	.010	.25	.230	5.84
6328UL	10	solid	1000	305	73.0	33.1	.010	.25	.272	6.91
16 AWG										
6220UL*	2	solid	C-500 500 U-1000 1000	C-152 152 U-305 305	12.0 12.5 25.0 26.0	5.4 5.7 11.4 11.8	.010	.25	.174	4.42
6222UL	4	solid	500 1000	152 305	24.5 47.0	11.1 21.3	.010	.25	.204	5.18
14 AWG										
6120UL*	2	solid	500 1000	152 305	19.0 38.0	8.6 17.3	.011	.28	.205	5.21
6122UL	4	solid	500 1000	152 305	35.5 70.0	16.1 31.8	.011	.28	.241	6.12
12 AWG										
6020UL	2	solid	1000	305	59.0	26.8	.011	.28	.239	6.07

Shielded Multi-conductor (NEC FPLP)

18 AWG										
6320FL*	2	solid	C-500 U-1000 1000	C-152 U-305 305	10.5 22.0 22.0	4.8 10.0 10.0	.010	.25	.158	4.01
6322FL	4	solid	1000	305	36.0	16.4	.010	.25	.183	4.65
16 AWG										
6220FL*	2	solid	C-500 1000	C-152 305	14.5 31.0	6.6 14.1	.010	.25	.181	4.60
6222FL	4	solid	1000	305	58.0	26.3	.010	.25	.211	5.36
14 AWG										
6120FL*	2	solid	500 1000	152 305	23.5 45.0	10.7 20.4	.011	.28	.209	5.31
6122FL	4	solid	500 1000	152 305	42.0 77.0	19.1 35.0	.011	.28	.245	6.22
12 AWG										
6020FL	2	solid	500 1000	152 305	30.5 61.0	13.9 27.7	.011	.28	.243	6.17

*Also available in other jacket colors. Consult www.belden.com.

Fire Alarm Cable

Commercial Applications, Addressable Systems

Unshielded and Shielded, Plenum-Rated, Power-Limited, Mid-Capacitance



Unshielded Multi-conductor

FPLP Rated

Product Description

Bare copper conductors, FEP insulation, cabled together, Red Flam arrest® jacket with rip cord. Sequential footage marking every two feet.

Color Code: Black, Red.

Shielded Multi-conductor

FPLP Rated

Product Description

Bare copper conductors, FEP insulation, cabled together, Beldfoil® shield tape (aluminum side out) with tinned copper drain wire, Red Flam arrest jacket with rip cord. Sequential footage marking every two feet.

Color Code: Black, Red.

Specifications

Conductor	Bare Copper
Insulation	FEP
Shield (where applicable)	Beldfoil
Jacket	Flam arrest
Jacket Thickness	.015" (.381mm)
Approvals	
NEC	FPLP
California State Fire Marshall	
NEC Articles	760
Voltage Rating	300V
Temperature Rating	75°C
Nominal Capacitance*	
Unshielded†	26 pF/ft.
Shielded††	26–31 pF/ft.

*Capacitance between conductors.

†20% lower capacitance than cables on page 13.39

††60% lower capacitance than cables on page 13.39

Applications

- Addressable Fire Systems
- Data Circuits
- Monitor/Detection
- Control Circuits
- Initiating Circuits
- Notification Circuits

Part No.	No. of Cond.	Stranding	Standard Lengths		Standard Unit Weight		Insulation Thickness		Nominal OD	
			Ft.	m	Lbs.	kg	Inch	mm	Inch	mm

Unshielded Multi-conductor (NEC FPLP)

18 AWG										
6320UJ	2	solid	1000	305	16.0	7.3	.007	.18	.138	3.51
16 AWG										
6220UJ	2	solid	1000	305	24.0	10.9	.007	.18	.162	4.11
14 AWG										
6120UJ	2	solid	1000	305	32.0	14.5	.007	.18	.186	4.72

Shielded Multi-conductor (NEC FPLP)

18 AWG										
6320FK	2	solid	500	152	14.0	6.4	.018	.46	.185	4.70
			U-1000	U-305	28.0	12.7				
			1000	305	27.0	12.2				
16 AWG										
6220FK	2	solid	1000	305	37.0	16.8	.018	.46	.210	5.33

Unshielded



Shielded

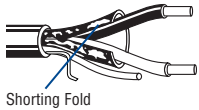

Shorting Fold

Circuit Integrity in Conduit (CIC) Safe-T-Line® Cable

Commercial Applications, Addressable Systems

Unshielded, Riser-Rated



Unshielded Multi-conductor

FPLR-CIC Rated

Product Description

Bare copper conductors, ceramifiable silicone rubber insulation, Red FRPE (Low-Smoke, Non-Halogen) jacket. Sequential footage marking every two feet.

Color Code: Black, Red.

Specifications

Conductor	Bare Copper
Insulation	Silicone Rubber
Shield	Unshielded
Jacket	FRPE
Jacket Thickness	.035" (.889mm)
Approvals	
NEC	FPLR-CIC
NEC Articles	760
Voltage Rating	300V
Temperature Rating	105°C

Note: 2-conductor versions are color-coded black and red.
4 or more conductor versions are all black and numbered.

Applications

- Circuit Integrity
- Fire Alarm Circuit Integrity
- Survivability
- Survivability from Attack by Fire

Stranded



Solid



Part No.	No. of Cond.	Stranding	Standard Lengths		Standard Unit Weight		Outer Jacket Thickness		Nominal OD	
			Ft.	m	Lbs.	kg	Inch	mm	Inch	mm

Unshielded Multi-conductor (NEC FPLR-CIC)

16 AWG										
5200UZ <small>NEW</small>	2	7	1000	305	68.0	30.9	.056	1.42	.37	9.40
5220UZ <small>NEW</small>	2	solid	1000	305	64.0	29.0	.056	1.42	.35	8.89
14 AWG										
5100UZ <small>NEW</small>	2	7	1000	305	87.0	39.5	.056	1.42	.40	10.16
5120UZ <small>NEW</small>	2	solid	1000	305	79.0	35.8	.056	1.42	.38	9.65
12 AWG										
5000UZ <small>NEW</small>	2	7	1000	305	108.0	50.0	.056	1.42	.37	9.40
5020UZ <small>NEW</small>	2	solid	1000	305	101.0	45.8	.056	1.42	.42	10.67

FRPE = Flame-retardant Polyethylene

20 • New Generation® Cables

Circuit Integrity in Conduit (CIC) Safe-T-Line® Cable

Commercial Applications, Addressable Systems

Shielded, Riser-Rated



Shielded Multi-conductor

FPLR-CIC Rated

Product Description

Bare copper conductors, ceramifiable silicone rubber insulation, overall Beldfoil® Shield (100% coverage), tinned copper drain wire, Red FRPE (Low-Smoke, Non-Halogen) jacket, Sequential footage marking every two feet.

Color Code: Black, Red. (see note)

Specifications

Conductor	Bare Copper
Insulation	Silicone Rubber
Shield	Beldfoil
Jacket	FRPE
Jacket Thickness	.035" (.889mm)
Approvals	NEC FPLR-CIC
NEC Articles	760
Voltage Rating	300V
Temperature Rating	105°C

Note: 2-conductor versions are color-coded black and red. 4 or more conductor versions are all black and numbered.

Applications

- Circuit Integrity
- Fire Alarm Circuit Integrity
- Survivability
- Survivability from Attack by Fire

Stranded



Solid



Part No.	No. of Cond.	Stranding	Standard Lengths		Standard Unit Weight		Outer Jacket Thickness		Nominal OD	
			Ft.	m	Lbs.	kg	Inch	mm	Inch	mm

Shielded Multi-conductor (NEC FPLR-CIC)

16 AWG										
5200FZ <small>NEW</small>	2	7	1000	305	75.0	34.0	.056	1.42	.37	9.40
5220FZ <small>NEW</small>	2	solid	1000	305	71.0	32.2	.056	1.42	.36	9.14
5222FZ <small>NEW</small>	4	solid	1000	305	108.0	50.0	.056	1.42	.41	10.41
14 AWG										
5100FZ <small>NEW</small>	2	7	1000	305	97.0	44.0	.056	1.42	.41	10.41
5120FZ <small>NEW</small>	2	solid	1000	305	90.0	40.8	.056	1.42	.38	9.65
12 AWG										
5000FZ <small>NEW</small>	2	7	1000	305	122.0	55.3	.056	1.42	.44	11.18
5020FZ <small>NEW</small>	2	solid	1000	305	117.0	53.1	.056	1.42	.42	10.67
5022FZ <small>NEW</small>	4	solid	1000	305	187.0	84.8	.056	1.42	.48	12.19

FRPE = Flame-retardant Polyethylene

Circuit Integrity (CI) Safe-T-Line® Cable

Commercial Applications, Addressable Systems
Unshielded, Riser-Rated



Unshielded Multi-conductor FPLR-CI Rated

Product Description

Solid bare copper conductors, ceramifiable silicone rubber insulation, Red FRPE (Low-Smoke, Non-Halogen) jacket. Sequential footage marking every two feet.

Color Code: Black, Red. (see note)

Specifications

Conductor	Bare Copper
Insulation	Silicone Rubber
Shield	Unshielded
Jacket	FRPE
Jacket Thickness	.045" (1.143mm)
Approvals	NEC FPLR-CI California State Fire Marshall
NEC Articles	760
Voltage Rating	300V
Temperature Rating	105°C
Nominal Capacitance	
18 AWG	17 pF/ft.
16 AWG	19 pF/ft.
14 AWG	21 pF/ft.
12 AWG	23 pF/ft.

Note: 2-conductor versions are color-coded black and red.
4 or more conductor versions are all black and numbered.

Applications

- Circuit Integrity
- Fire Alarm Circuit Integrity
- Survivability
- Survivability from Attack by Fire



Part No.	No. of Cond.	Stranding	Standard Lengths		Standard Unit Weight		Insulation Thickness		Nominal OD	
			Ft.	m	Lbs.	kg	Inch	mm	Inch	mm
Unshielded Multi-conductor (NEC FPLR-CI)										
18 AWG										
5320UM <small>NEW</small>	2	solid	1000	305	47.0	21.3	.034	.86	.31	7.87
5322UM <small>NEW</small>	4	solid	1000	305	73.0	33.1	.034	.86	.35	8.89
5324UM <small>NEW</small>	6	solid	1000	305	100.0	45.4	.034	.86	.42	10.67
5326UM <small>NEW</small>	8	solid	1000	305	123.0	55.8	.034	.86	.45	11.43
16 AWG										
5220UM <small>NEW</small>	2	solid	1000	305	59.0	26.8	.034	.86	.33	8.38
5222UM <small>NEW</small>	4	solid	1000	305	97.0	44.0	.034	.86	.38	9.65
14 AWG										
5120UM <small>NEW</small>	2	solid	1000	305	73.0	33.1	.034	.86	.36	9.14
5122UM <small>NEW</small>	4	solid	1000	305	123.0	55.8	.034	.86	.41	10.41
12 AWG										
5020UM <small>NEW</small>	2	solid	1000	305	96.0	43.6	.034	.86	.39	9.91
5022UM <small>NEW</small>	4	solid	1000	305	167.0	75.8	.034	.86	.45	11.43

FRPE = Flame-retardant Polyethylene

Circuit Integrity (CI) Safe-T-Line® Cable

Commercial Applications, Addressable Systems

Shielded, Riser-Rated



Shielded Multi-conductor

FPLR-CI Rated

Product Description

Bare copper conductors, ceramifiable silicone rubber insulation, Beldfoil® shield (100% coverage), Red FRPE (Low-Smoke, Non-Halogen) jacket, drain wire. Sequential footage marking every two feet.

Color Code: Black, Red.

Specifications

Conductor	Bare Copper
Insulation	Silicone Rubber
Shield	Beldfoil
Jacket	FRPE
Jacket Thickness	.045" (1.143mm)
Approvals	FPLR-CI
NEC	
California State Fire Marshall	
NEC Articles	760
Voltage Rating	300V
Temperature Rating	105°C
Nominal Capacitance	
18 AWG	27 pF/ft.
16 AWG	31 pF/ft.
14 AWG	33 pF/ft.
12 AWG	37 pF/ft.*
	40 pF/ft.**

* 5020FM and 5022FM
 ** 5000FM and 5002FM

Note: 2-conductor versions are color-coded black and red. 4 or more conductor versions are all black and numbered.

Applications

- Circuit Integrity
- Fire Alarm Circuit Integrity
- Survivability
- Survivability from Attack by Fire



Part No.	No. of Cond.	Stranding	Standard Lengths		Standard Unit Weight		Insulation Thickness		Nominal OD	
			Ft.	m	Lbs.	kg	Inch	mm	Inch	mm

Shielded Multi-conductor (NEC FPLR-CI)

18 AWG										
5320FM <small>NEW</small>	2	solid	1000	305	50.0	22.7	.034	.86	.31	7.87
5322FM <small>NEW</small>	4	solid	1000	305	78.0	35.4	.034	.86	.36	9.14
5324FM <small>NEW</small>	6	solid	1000	305	106.0	48.1	.034	.86	.42	10.67
5326FM <small>NEW</small>	8	solid	1000	305	129.0	58.5	.034	.86	.46	11.61
5300FM <small>NEW</small>	2	(7x26)	1000	305	57.0	25.9	.034	.86	.32	8.13
5302FM <small>NEW</small>	4	(7x26)	1000	305	103.0	46.7	.034	.86	.37	9.40
5304FM <small>NEW</small>	6	(7x26)	1000	305	122.0	55.3	.034	.86	.44	11.18
5306FM <small>NEW</small>	8	(7x26)	1000	305	148.0	67.1	.034	.86	.47	11.94
16 AWG										
5220FM <small>NEW</small>	2	solid	1000	305	66.0	29.9	.034	.86	.33	8.38
5222FM <small>NEW</small>	4	solid	1000	305	103.0	46.7	.034	.86	.38	9.65
5200FM <small>NEW</small>	2	(7x24)	1000	305	71.0	32.2	.034	.86	.35	8.89
5202FM <small>NEW</small>	4	(7x24)	1000	305	112.0	50.8	.034	.86	.40	10.16
14 AWG										
5120FM <small>NEW</small>	2	solid	1000	305	84.0	38.1	.034	.86	.36	9.14
5122FM <small>NEW</small>	4	solid	1000	305	133.0	60.3	.034	.86	.41	10.41
5100FM <small>NEW</small>	2	(7x22)	1000	305	93.0	42.2	.034	.86	.38	9.65
5102FM <small>NEW</small>	4	(7x22)	1000	305	149.0	67.6	.034	.86	.44	11.18
12 AWG										
5020FM <small>NEW</small>	2	solid	1000	305	112.0	50.8	.034	.86	.39	9.91
5022FM <small>NEW</small>	4	solid	1000	305	183.0	83.0	.034	.86	.46	11.68
5000FM <small>NEW</small>	2	(7x20)	1000	305	117.0	53.1	.034	.86	.42	10.67
5002FM <small>NEW</small>	4	(7x20)	1000	305	189.0	85.7	.034	.86	.48	12.19

FRPE = Flame-retardant Polyethylene

Speaker Cable

Commercial Audio Systems
Unshielded, Riser-Rated



Unshielded Multi-conductor
CMR/CMG FT4 Rated or CL3R Rated

Product Description

Bare copper conductors, PVC insulation, Gray PVC jacket with rip cord. Sequential footage marking every two feet.

Color Code: See chart below.

Specifications

Conductor	Bare Copper
Insulation	PVC
Insulation Thickness	
22 to 16 AWG	.010" (.254mm)
14 to 12 AWG	.014" (.356mm)
NEC Articles	725
Jacket	PVC
Approvals	
NEC (22 to 16 AWG)	CMR FPLR†
CEC (22 to 16 AWG)	CMG FT4
NEC (14 to 12 AWG)	CL3R
NEC Articles	
22 to 16 AWG	800
14 to 12 AWG	725
Voltage Rating	300V
Temperature Rating	75°C

†CMR FPLR dual rating for 5000UE, 5100UE, 5000FE and 5100FE only.

Applications

- Intercom/PA Systems
- Sound/Audio Systems
- Security Systems
- Power Limited Controls
- Single Line Telephone

Solid Conductor



Stranded Conductor



Color Code Chart
(22 to 16 AWG)

Cond. No.	Color	Cond. No.	Color
1	Black	1	Black
2	Red	2	White
3	White	3	Red

(14 to 12 AWG)

Part No.	No. of Cond.	Stranding	Standard Lengths		Standard Unit Weight		Outer Jacket Thickness		Nominal OD	
			Ft.	m	Lbs.	kg	Inch	mm	Inch	mm

Unshielded Multi-conductor (NEC CMR and CEC CMG FT4)

22 AWG										
5520UE	2	solid	C-500	C-152	4.0	1.8	.015	.38	.122	3.10
			U-500	U-152	5.5	2.5				
			C-1000	C-305	8.0	3.6				
			U-1000	U-305	9.0	4.1				
			1000	305	9.0	4.1				
5500UE	2	7	C-500	C-152	4.0	1.8	.015	.38	.128	3.25
			U-500	U-152	5.5	2.5				
			500	152	5.5	2.5				
			C-1000	C-305	8.0	3.6				
			U-1000	U-305	10.0	4.5				
			1000	305	9.0	4.1				
5501UE	3	7	U-1000	U-305	13.0	5.9	.015	.38	.135	3.43
			1000	305	13.0	5.9				
20 AWG										
5400UE	2	7	C-500	C-152	6.0	2.7	.015	.38	.142	3.61
			U-1000	U-305	13.0	5.9				
			1000	305	13.0	5.9				
5401UE	3	7	500	152	9.0	4.1	.015	.38	.150	3.81
			U-1000	U-305	18.0	8.2				
			1000	305	18.0	8.2				
18 AWG										
5320UE	2	solid	C-500	C-152	7.5	3.4	.015	.38	.151	3.84
			U-1000	U-305	17.0	7.7				
5300UE*	2	7	C-500	C-152	8.5	3.9	.015	.38	.161	4.09
			U-500	U-152	9.5	4.3				
			500	152	9.5	4.3				
			U-1000	U-305	17.0	7.7				
			1000	305	18.0	8.2				
5321UE	3	solid	U-1000	U-305	23.0	10.4	.015	.38	.160	4.06
			1000	305	23.0	10.4				
5301UE	3	7	500	152	12.5	5.7	.015	.38	.171	4.34
			U-1000	U-305	25.0	11.3				
			1000	305	25.0	11.3				
16 AWG										
5200UE	2	19	C-500	C-152	11.5	5.2	.015	.38	.184	4.67
			U-500	U-152	13.0	5.9				
			500	152	12.5	5.7				
			U-1000	U-305	24.0	10.9				
			1000	305	25.0	11.4				
5201UE	3	19	U-500	U-152	18.5	8.4	.015	.38	.196	4.98
			500	152	18.0	8.2				
			U-1000	U-305	35.0	15.9				
			1000	305	38.0	17.3				

Unshielded Multi-conductor (NEC CL3R)

14 AWG										
5100UE**	2	19	500	152	20.0	9.1	.015	.38	.234	5.94
			U-1000	U-305	38.0	17.2				
			1000	305	40.0	18.2				
5101UE	3	19	1000	305	56.0	25.4	.015	.38	.249	6.32
12 AWG										
5000UE**	2	19	500	152	29.0	13.2	.015	.38	.268	6.81
			1000	305	57.0	25.9				
5001UE	3	19	1000	305	82.0	37.3	.015	.38	.286	7.26

* 5300UE also available in White or Black.
** 5100UE and 5000UE also available in Red.

High Strand Speaker Cable

Commercial Audio Systems
Unshielded, High-Flex and High-Purity



High Strand Unshielded Multi-conductor

CM, CL3 or CL2 Rated

Product Description

Bare high-conductivity ETP copper conductors, highly stranded for ultra flexibility, high-grade PVC insulation, PVC jacket with rip cord. Available jacket colors: Blue, Green, White, Black and Gray. Sequential footage marking every two feet.

Color Code: See chart below.

Specifications

Conductor	Bare High-conductivity ETP Copper		
Insulation	High-grade PVC		
Insulation Thickness			
18 AWG to 16 AWG	.015" (.381mm)		
14 AWG to 10 AWG	.020" (.508mm)		
Jacket	PVC		
Approvals			
NEC (18 AWG & 16 AWG)	CM		
NEC (14 AWG & 12 AWG)	CL3		
NEC (10 AWG)	CL2, Audio Use Only		
Temperature Rating	75°C		

Applications

- Speaker Systems
- Sound/Audio Systems
- Intercom/PA Systems
- Home Theater and Entertainment Systems
- Stadium and Arena Speaker Systems



Part No.	No. of Cond.	Stranding	Standard Lengths		Standard Unit Weight		Outer Jacket Thickness		Nominal OD	
			Ft.	m	Lbs.	kg	Inch	mm	Inch	mm

High Strand Unshielded Multi-conductor (NEC CM, CL3 or CL2)

18 AWG (NEC CM)										
5300UP	2	42	U-500	U-152	11.0	5.0	.015	.38	.184	4.67
			500	152	12.0	5.5				
			U-1000	U-305	20.0	9.1				
			1000	305	20.0	9.1				
5302UP										
5302UP	4	42	U-500	U-152	18.5	8.4	.015	.38	.216	5.49
			500	152	19.0	8.6				
			U-1000	U-305	35.0	15.9				
			1000	305	37.0	16.8				
16 AWG (NEC CM)										
5200UP	2	65	U-500	U-152	14.5	6.6	.015	.38	.208	5.28
			500	152	14.5	6.6				
			U-1000	U-305	28.0	12.7				
			1000	305	28.0	12.7				
5202UP										
5202UP	4	65	U-500	U-152	25.5	11.6	.015	.38	.244	6.20
			500	152	26.0	11.8				
			U-1000	U-305	49.0	22.2				
			1000	305	51.0	23.2				
14 AWG (NEC CL3)										
5100UP	2	42	U-500	U-152	21.0	9.5	.015	.38	.260	6.60
			500	152	22.5	10.2				
			U-1000	U-305	41.0	18.6				
			1000	305	43.0	19.5				
5102UP										
5102UP	4	42	500	152	41.0	18.6	.018	.46	.313	7.95
			1000	305	81.0	36.8				
12 AWG (NEC CL3)										
5000UP	2	65	U-500	U-152	31.0	14.1	.018	.46	.302	7.67
			500	152	32.5	14.7				
			1000	305	64.0	29.1				
5002UP										
5002UP	4	65	500	152	60.0	27.2	.018	.46	.357	9.07
			1000	305	121.0	55.0				
10 AWG (NEC CL2 • Audio Use Only)										
5T00UP*	2	65	500	152	49.5	22.5	.026	.66	.356	9.04
			1000	305	96.0	43.6				

*Available in Gray only.

For Plenum version of 5T00UP, see 6T00UP on page 13.60.

Color Code Chart

Cond. No.	Color
1	Black
2	White
3	Red
4	Green

Audio Cable

Commercial Audio Systems
Shielded, Riser-Rated or CL3R Rated



Shielded Multi-conductor
CMR/CMG FT4 Rated or CL3R Rated

Product Description

Bare copper conductors, PVC insulation, conductors cabled, Beldfoil® shield tape (foil side out) with drain wire, Gray PVC jacket with rip cord. Sequential footage marking every two feet.

Color Code: See chart below.

Specifications

Conductor	Bare Copper
Insulation	PVC
Insulation Thickness	
24 to 16 AWG	.010" (.254mm)
14 to 12 AWG	.014" (.356mm)
Shield	Beldfoil
Jacket	PVC
Approvals	
NEC (24 to 16 AWG)	CMR FPLR†
CEC (24 to 16 AWG)	CMG FT4
NEC (14 to 12 AWG)	CL3R

NEC Articles	
24 to 16 AWG	800
14 to 12 AWG	725

Voltage Rating	300V
Temperature Rating	75°C

†CMR FPLR dual rating for 5000UE, 5100UE, 5000FE and 5100FE only.

Applications

- Intercom/PA Systems
- Sound/Audio Systems
- Fire Alarm Systems (Red Only)

Solid Conductor

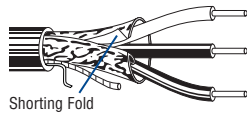

Shorting Fold

Stranded Conductor

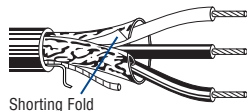

Shorting Fold

Color Code Chart

(24 to 16 AWG)

Cond. No.	Color	Cond. No.	Color
1	Black	1	Black
2	Red	2	White
3	White	3	Red

(14 to 12 AWG)

Part No.	No. of Cond.	Stranding	Standard Lengths		Standard Unit Weight		Outer Jacket Thickness		Nominal OD	
			Ft.	m	Lbs.	kg	Inch	mm	Inch	mm

Shielded Multi-conductor (NEC CMR and CEC CMG FT4)

24 AWG										
5600FE	2	7	U-1000 1000	U-305 305	11.0 10.0	5.0 4.5	.015	.38	.120	3.05

22 AWG										
5520FE	2	solid	C-500 C-1000 U-1000 1000	C-152 C-305 U-305 305	6.5 13.0 14.0 14.0	3.0 5.9 6.4 6.4	.015	.38	.125	3.18

5500FE	2	7	C-500 U-500 500 U-1000 1000	C-152 U-152 152 U-305 305	5.5 6.5 6.5 12.0 12.0	2.5 3.0 3.0 5.5 5.5	.015	.38	.130	3.30
--------	---	---	---	---------------------------------------	-----------------------------------	---------------------------------	------	-----	------	------

5521FE	3	solid	U-1000 1000	U-305 305	12.0 12.0	5.4 5.4	.015	.38	.132	3.35
--------	---	-------	----------------	--------------	--------------	------------	------	-----	------	------

5501FE	3	7	C-500 U-500 500 U-1000 1000	C-152 U-152 152 U-305 305	7.0 8.0 7.5 15.0 15.0	3.2 3.6 3.4 6.8 6.8	.015	.38	.138	3.51
--------	---	---	---	---------------------------------------	-----------------------------------	---------------------------------	------	-----	------	------

20 AWG										
5400FE	2	7	U-500 500 U-1000 1000	U-152 152 U-305 305	9.0 8.5 17.0 17.0	4.1 3.9 7.7 7.7	.015	.38	.145	3.68

5421FE	3	solid	U-1000	U-305	20.0	9.1	.015	.38	.146	3.71
--------	---	-------	--------	-------	------	-----	------	-----	------	------

5401FE	3	7	U-500 500 U-1000 1000	U-152 152 U-305 305	11.0 10.5 21.0 21.0	5.0 4.8 9.5 9.5	.015	.38	.153	3.89
--------	---	---	--------------------------------	------------------------------	------------------------------	--------------------------	------	-----	------	------

18 AWG										
5320FE	2	solid	C-500 U-1000 1000	C-152 U-305 305	10.0 21.0 21.0	4.5 9.5 9.5	.015	.38	.155	3.94

5300FE	2	7	C-500 U-500 500 U-1000 1000	C-152 U-152 152 U-305 305	11.0 12.0 12.0 23.0 23.0	5.0 5.4 5.4 10.4 10.4	.015	.38	.165	4.19
--------	---	---	---	---------------------------------------	--------------------------------------	-----------------------------------	------	-----	------	------

5301FE	3	7	U-500 500 U-1000 1000	U-152 152 U-305 305	15.5 15.0 30.0 30.0	7.0 6.8 13.6 13.6	.015	.38	.175	4.45
--------	---	---	--------------------------------	------------------------------	------------------------------	----------------------------	------	-----	------	------

16 AWG										
5200FE*	2	19	U-500 500 U-1000 1000	U-152 152 U-305 305	16.5 16.5 31.0 32.0	7.5 7.5 14.1 14.5	.015	.38	.188	4.78

5201FE	3	19	500 U-1000 1000	152 U-305 305	21.5 42.0 42.0	9.8 19.1 19.1	.015	.38	.200	5.08
--------	---	----	-----------------------	---------------------	----------------------	---------------------	------	-----	------	------

Shielded Multi-conductor (NEC CL3R)

14 AWG										
5100FE**	2	19	500 U-1000 1000	152 U-305 305	28.5 49.0 51.0	13.0 22.3 23.2	.015	.38	.238	6.05

5101FE	3	19	1000	305	66.0	30.0	.015	.38	.253	6.43
--------	---	----	------	-----	------	------	------	-----	------	------

12 AWG										
5000FE**	2	19	500 1000	152 305	36.5 67.0	16.6 30.4	.015	.38	.272	6.91

* 5200FE also available in White.

** 5100FE and 5000FE also available in Red (rating FPLR).



Audio Cable

Commercial Audio Systems
Unshielded, Plenum-Rated



Unshielded Multi-conductor

CMP FT6 Rated or CL2P Rated

Product Description

Bare copper conductors, Flamarrest® insulation, conductors cabled, Natural Flamarrest jacket with rip cord. Sequential footage marking every two feet.

Color Code: See chart below.

Specifications

Conductor	Bare Copper
Insulation	Flamarrest
Insulation Thickness	
22 to 16 AWG	.009" (.229mm)
14 to 10 AWG	.011" (.279mm)
Jacket	Flamarrest
Approvals	
NEC (22 to 16 AWG)	CMP
CEC (22 to 16 AWG)	CMP FT6
NEC (14 to 10 AWG)	CL2P
NEC Articles	
22 to 16 AWG	800
14 to 10 AWG	725
Voltage Rating	
22 to 16 AWG	300V
14 to 10 AWG	150V
Temperature Rating	75°C

Applications

- Intercom/PA Systems
- Sound/Audio Systems

Solid Conductor



Stranded Conductor



Color Code Chart

(22 to 16 AWG)

(14 to 10 AWG)

Cond. No.	Color	Cond. No.	Color
1	Black	1	Black
2	Red	2	White
3	White	3	Red

Part No.	No. of Cond.	Stranding	Standard Lengths		Standard Unit Weight		Outer Jacket Thickness		Nominal OD	
			Ft.	m	Lbs.	kg	Inch	mm	Inch	mm

Unshielded Multi-conductor (NEC CMP and CEC CMP FT6)

22 AWG										
6520UE	2	solid	U-1000 1000	U-305 305	10.0 9.0	4.5 4.1	.015	.38	.118	3.00
6500UE	2	7	C-500 C-1000 U-1000 1000	C-152 C-305 U-305 305	4.5 9.0 10.0 10.0	2.0 4.1 4.5 4.5	.015	.38	.124	3.15
6521UE	3	solid	1000	305	13.0	5.9	.015	.38	.125	3.18
6501UE	3	7	U-1000 1000	U-305 305	14.0 13.0	6.4 5.9	.015	.38	.131	3.33
20 AWG										
6400UE	2	7	C-500 500 U-1000 1000	C-152 152 U-305 305	6.0 7.0 14.0 14.0	2.7 3.2 6.4 6.4	.015	.38	.138	3.51
6401UE	3	7	U-1000 1000 5000	U-305 305 1524	19.0 18.0 90.0	8.6 8.2 40.9	.015	.38	.146	3.71
18 AWG										
6320UE	2	solid	U-1000	U-305	17.0	7.7	.015	.38	.147	3.73
6300UE	2	7	C-500 U-500 500 U-1000 1000 5000	C-152 U-152 152 U-305 305 1524	8.0 9.5 9.0 18.0 18.0 90.0	3.6 4.3 4.1 8.2 8.2 40.9	.015	.38	.157	3.99
6321UE	3	solid	U-1000 1000	U-305 305	24.0 24.0	10.9 10.9	.015	.38	.156	3.96
6301UE	3	7	500 U-1000 1000	152 U-305 305	12.5 25.0 25.0	5.7 11.4 11.4	.015	.38	.168	4.27
16 AWG										
6200UE	2	19	500 U-1000 1000	152 U-305 305	13.0 25.0 26.0	5.9 11.3 11.8	.015	.38	.180	4.57
6201UE	3	19	500 U-1000 1000	152 U-305 305	18.0 36.0 37.0	8.2 16.4 16.8	.015	.38	.191	4.85

Unshielded Multi-conductor (NEC CL2P)

14 AWG										
6100UE	2	19	500 U-1000 1000 5000	152 U-305 305 1524	19.5 38.0 38.0 195.0	8.9 17.2 17.2 88.5	.015	.38	.222	5.64
6101UE	3	19	1000	305	56.0	25.4	.015	.38	.236	5.99
12 AWG										
6000UE	2	19	500 1000	152 305	32.0 58.0	14.5 26.4	.015	.38	.256	6.50
6001UE	3	19	1000	305	83.0	37.7	.015	.38	.273	6.93
10 AWG (For Audio Use Only)										
6T00UP	2	65	1000	305	85.0	38.6	.015	.38	.308	7.82

Audio Cable

Commercial Audio Systems
Shielded, Plenum-Rated



Shielded Multi-conductor
CMP FT6 Rated or CL2P Rated

Product Description

Bare copper conductors, Flamarrest® insulation, conductors cabled, overall Beldfoil® tape shield (foil side out) and drain wire, Natural Flamarrest jacket with rip cord. Sequential footage marking every two feet.

Color Code: See chart below.

Specifications

Conductor	Bare Copper		
Insulation	Flamarrest		
Insulation Thickness			
22 to 16 AWG	.009" (.229mm)		
14 to 12 AWG	.011" (.279mm)		
Shield	Beldfoil		
Jacket	Flamarrest		
Approvals			
NEC (22 to 16 AWG)	CMP		
CEC (22 to 16 AWG)	CMP FT6		
NEC (14 to 12 AWG)	CL2P		
NEC Articles			
22 to 16 AWG	800		
14 to 12 AWG	725		
Voltage Rating			
22 to 16 AWG	300V		
14 to 12 AWG	150V		
Temperature Rating	75°C		

Applications

- Intercom/PA Systems
- Sound/Audio Systems

Solid Conductor

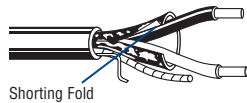

Stranded Conductor

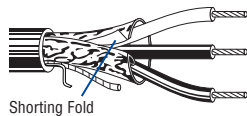

Color Code Chart (22 to 16 AWG)

Cond. No.	Color	Cond. No.	Color
1	Black	1	Black
2	Red	2	White
3	White	3	Red

(14 to 12 AWG)

Part No.	No. of Cond.	Stranding	Standard Lengths		Standard Unit Weight		Outer Jacket Thickness		Nominal OD	
			Ft.	m	Lbs.	kg	Inch	mm	Inch	mm

Shielded Multi-conductor (NEC CMP and CEC CMP FT6)

22 AWG

6520FE	2	solid	C-500	C-152	6.0	2.7	.015	.38	.122	3.10
			C-1000	C-305	12.0	5.4				
			U-1000	U-305	13.0	5.9				
			1000	305	13.0	5.9				

6500FE	2	7	C-500	C-152	5.5	2.5	.015	.38	.128	3.25
			U-500	U-152	7.0	3.2				
			500	152	7.0	3.2				
			C-1000	C-305	11.0	5.0				
			U-1000	U-305	13.0	5.9				
1000	305	13.0	5.9							

6521FE	3	solid	1000	305	16.0	7.3	.015	.38	.129	3.28
--------	---	-------	------	-----	------	-----	------	-----	------	------

6501FE	3	7	500	152	8.0	3.6	.015	.38	.135	3.43
			U-1000	U-305	16.0	7.3				
			1000	305	16.0	7.3				

20 AWG

6420FE	2	solid	C-500	C-152	7.0	3.2	.015	.38	.134	3.40
			U-1000	U-305	16.0	7.3				
			1000	305	15.0	6.8				

6400FE	2	7	C-500	C-152	7.5	3.4	.015	.38	.142	3.60
			U-1000	U-305	17.0	7.7				
			1000	305	17.0	7.7				

6401FE	3	7	U-1000	U-305	21.0	9.5	.015	.38	.150	3.81
			1000	305	22.0	10.0				

18 AWG

6320FE	2	solid	C-500	C-152	10.5	4.7	.015	.38	.150	3.81
			1000	305	22.0	10.0				

6300FE	2	7	C-500	C-152	11.0	5.0	.015	.38	.162	4.11
			U-500	U-152	12.0	5.4				
			500	152	12.0	5.4				
			U-1000	U-305	23.0	10.4				
			1000	305	23.0	10.4				

6301FE	3	7	U-500	U-152	15.5	7.0	.015	.38	.172	4.32
			U-1000	U-305	30.0	13.6				
			1000	305	31.0	14.1				

16 AWG

6200FE	2	19	500	152	16.5	7.5	.015	.38	.184	4.67
			1000	305	33.0	15.0				

6201FE	3	19	500	152	22.5	10.2	.015	.38	.195	4.95
			U-1000	U-305	43.0	19.5				
			1000	305	45.0	20.5				

Shielded Multi-conductor (NEC CL2P)

14 AWG

6100FE	2	19	500	152	25.0	11.3	.015	.38	.220	5.59
			U-1000	U-305	49.0	22.2				
			1000	305	51.0	23.2				

6101FE	3	19	1000	305	66.0	30.0	.015	.38	.234	5.94
--------	---	----	------	-----	------	------	------	-----	------	------

12 AWG

6000FE	2	19	500	152	36.0	16.4	.015	.38	.260	6.60
			1000	305	68.0	30.9				

Audio Cable

Pro Audio and Intercom Systems
Shielded, Plenum-Rated



Shielded Multi-conductor

CMP FT6 Rated

Product Description

Bare copper conductors, FEP insulation, cabled with a Beldfoil® shield tape and drain wire. Natural Flamarrest® jacket.

Color Code: See chart below.

Specifications

Conductor	Bare Copper
Insulation	FEP
Insulation Thickness	
22 AWG	.0055" (.140mm)
20 AWG	.0060" (.152mm)
18 AWG	.0060" (.152mm)
Shield	Beldfoil
Jacket	Flamarrest
Approvals	
NEC	CMP
CEC	CMP FT6
NEC Articles	800
Voltage Rating	300V
Temperature Rating	75°C

Applications

- Pro Audio
- Intercom/PA Systems
- Security Systems



Shorting Fold

Part No.	No. of Cond.	Stranding	Standard Lengths		Standard Unit Weight		Outer Jacket Thickness		Nominal OD	
			Ft.	m	Lbs.	kg	Inch	mm	Inch	mm

Shielded Multi-conductor (NEC CMP and CEC CMP FT6)

22 AWG										
6500FC	2	7	U-1000	U-305	11.0	5.0	.015	.38	.116	2.95
			1000	305	11.0	5.0				
6502FC										
	4	7	1000	305	18.0	8.2	.015	.38	.133	3.38
20 AWG										
6400FC	2	7	U-1000	U-305	15.0	6.8	.015	.38	.133	3.38
18 AWG										
6300FC	2	7	U-1000	U-305	23.0	10.4	.017	.42	.155	3.94
			1000	305	22.0	10.0				
6302FC	4	7	1000	305	34.0	15.5	.017	.42	.179	4.55

Color Code Chart

Cond. No.	Color
1	Black
2	Red
3	White
4	Green

Audio Cable

Commercial Sound/Nurse Call Systems
Unshielded, Non-Plenum



**Unshielded,
Pairs or Multi-conductor**
CM Rated

Product Description

24 AWG solid bare copper conductors, polypropylene or polyolefin insulation, Dark Gray PVC jacket with rip cord.

Color Code: See Charts below.

Specifications

Conductor	Bare Copper
Insulation	
Multiconductor	Polypropylene
Paired	Polyolefin
Insulation Thickness	.0065" (.165mm)
Jacket	PVC
Nominal Capacitance	
Multiconductor	17 pF/ft.
Paired	15 pF/ft.
Approvals	
NEC	CM
CEC	CM
Voltage Rating	300V

Applications

- Nurse Call Systems
- Commercial Sound Systems
- Annunciators
- Voice Systems
- Paging

Paired

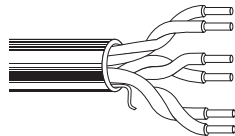

Multi-conductor



Part No.	No. of Cond.	Stranding	Standard Lengths		Standard Unit Weight		Outer Jacket Thickness		Nominal OD	
			Ft.	m	Lbs.	kg	Inch	mm	Inch	mm

Unshielded, Paired (NEC CM and CEC CM FT1)

24 AWG, Cat. 5e										
5662UG <small>NEW</small>	6	solid	1000	304.8	16.0	8.62	—	—	.172	4.37
	(3/pr)									

Unshielded, Multi-conductor (NEC CM and CEC CM)

24 AWG										
5626UG <small>NEW</small>	8	solid	1000	304.8	29.0	13.15	.030	.762	.093	2.36
									x	x
									.324	8.23
5624UG <small>NEW</small>	6	solid	1000	304.8	19.0	8.62	.024	.610	.081	2.06
									x	x
									.246	6.25

Color Code Chart

(5662UG)

Pair No.	Color Combinations
1	White/Blue Stripe & Blue
2	White/Orange Stripe & Orange
3	White/Green Stripe & Green

Color Code Chart

(5626UG)

Cond. No.	Color
1	Yellow
2	Blue
3	Black
4	Orange
5	Red
6	Green
7	White
8	Purple

Color Code Chart

(5624UG)

Cond. No.	Color
1	Blue
2	Black
3	Orange
4	Red
5	Green
6	White

Audio Cable

Commercial Sound/Nurse Call Systems
Unshielded, Plenum-Rated



**Unshielded,
Pairs or Multi-conductor**
CMP Rated

Product Description

24 AWG solid bare copper conductors, FEP insulation, Dark Gray Flammarrest® jacket with rip cord.

Color Code: See Charts below.

Specifications

Conductor	Bare Copper
Insulation	FEP
Insulation Thickness	.007" (.178mm)
Jacket	Flammarrest
Nominal Capacitance	15 pF/ft.
Approvals	
NEC	CMP
CEC	CMP FT6
Voltage Rating	300V

Applications

- Nurse Call Systems
- Commercial Sound Systems
- Annunciators
- Voice Systems
- Paging

Paired

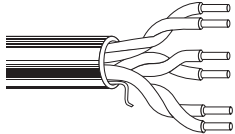

Multi-conductor



Part No.	No. of Cond.	Stranding	Standard Lengths		Standard Unit Weight		Outer Jacket Thickness		Nominal OD	
			Ft.	m	Lbs.	kg	Inch	mm	Inch	mm

Plenum-rated, Unshielded, Pairs (NEC CMP and CEC CMP FT4, FT6)

24 AWG, Cat. 5e										
6662UG <small>NEW</small>	6	solid	1000	304.8	23.0	10.4	—	—	.165	4.19

Plenum-rated, Unshielded, Multi-conductor (NEC CMP and CEC CMP FT6)

24 AWG										
6626UG <small>NEW</small>	8	solid	1000	304.8	28.0	12.70	.019	.483	.072	1.83
									x	x
									.310	7.87
6624UG <small>NEW</small>	6	solid	1000	304.8	21.0	9.53	.019	.483	.072	1.83
									x	x
									.246	6.25

Color Code Chart

(6662UG)

Pair No.	Color Combinations
1	White/Blue Stripe & Blue
2	White/Orange Stripe & Orange
3	White/Green Stripe & Green

Color Code Chart

(6626UG)

Cond. No.	Color
1	Yellow
2	Blue
3	Black
4	Orange
5	Red
6	Green
7	White
8	Purple

Color Code Chart

(6624UG)

Cond. No.	Color
1	Blue
2	Black
3	Orange
4	Red
5	Green
6	White



Residential Cables

21

Table of Contents

Residential Cables	Page No.
Introduction	21.2
Composite Data, Audio, Video, Security and Control Cable	21.3–21.8
Banana Peel® Jacketless Cables: Category 5e	21.3
Jacketed Cables: Category 5e and 5	21.5
Siamese Cables: Category 5e and 5	21.7
Keypad and Control Cables: Category 5e and 5	21.8
Data and Voice Cable	21.9–21.11
Category 6: 23 AWG UTP	21.9
Enhanced Category 5e: 24 AWG Bonded-Pair & UTP	21.10
Category 5e: 24 AWG UTP	21.11
Video Cable	21.12–21.19
Broadband CATV and DBS Coax: RG-6/U Type, 18 AWG	21.12
Precision Video Coax: RG-6/U Type, 18 AWG	21.14
Precision Video Coax: RG-59/U Type, 20 AWG	21.14
Precision Video Coax: Subminiature RG-59/U Type, 23 AWG	21.15
Standard Analog Coax: RG-59/U Type, 23 AWG	21.15
Bundled RGB Coax: Miniature, 25 AWG	21.16
BananaPeel® RGB Coax: Mini Hi-Res, 25 AWG	21.17
High-Flex S-Video Coax: 30 AWG	21.19
Speaker Cable	21.20–21.23
Low-Cap, OFHC Multi-conductor: 16 to 10 AWG	21.20
Multi-conductor: 16 to 12 AWG	21.21
High-Strand Multi-conductor: 16 to 10 AWG	21.22
High-Conductivity ETP Copper, Parallel: 16 to 12 AWG	21.23
Alarm, Security and Speaker Cable	21.24
Multi-conductor: 22 AWG	21.24
Multi-conductor: 18 AWG	21.24
Shielded Audio Cable	21.24
AES/EBU Digital Audio Cables: 24 AWG	21.24
Audio and Control Interconnect Cables: 22 AWG	21.24
Surveillance Coax	21.25
Coax: RG-59/U Type, 20 AWG	21.25
Composite: RG-59/U Type, 20 AWG	21.25
Composite: RG-6/U Type, 18 AWG	21.25
Tools and Accessories	21.26

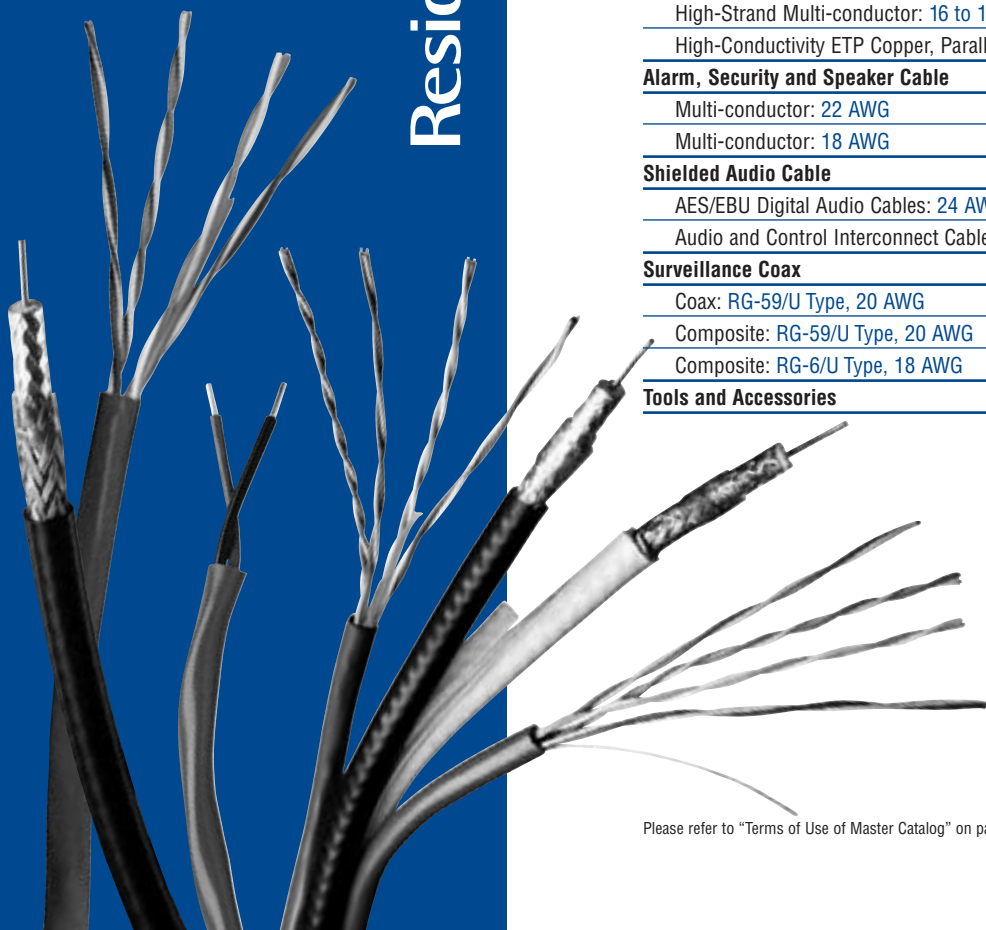

Introduction

Innovative Home Cabling Solutions From the World's Most Trusted Name in Cable

Because we understand that each home installation has its own set of needs and expectations, Belden offers its structured cabling line of individual, dual component and composite cables — in all, over 50 different cables for your home automation, networking, security and entertainment system installations.

Belden Quality and Reliability

Belden manufactures all of the cables in its residential cable line so you can be assured that each cable product is the result of the most rigorous quality process in the industry.

Belden's commitment to quality and reliability is unequaled in its marketplace. And since we have such a wide range of products to meet your varied needs, Belden can easily provide you with one-stop home shopping.

High-Performance, Easy-to-Install Cables

Individual or single application cables are available for any data, video, audio or security need, including:

- Category 5e, Category 6 UTP and fiber data cables for multimedia, voice, video and data use
- Series 6 and Series 59 video coax cables for HDTV, DBS, CATV, S-Video, CCTV and cable modem applications
- Speaker cables for your audio distribution needs
- Paired, unshielded cables for security and alarm applications

Belden also offers over 20 different composite cables. Composite cables simplify a multiple use installation by combining Belden data cables, coaxial cables, paired and multi-conductor cables, and fiber optic cables in a single-pull product.

Time-tested and Preferred in Other Industries

Many of the Belden® Residential Cables in this catalog have been long-standing leaders in other industries such as:

- **Computer networks** — where Belden offers the most innovative cables and the leading data cable technology worldwide.
- **Broadcast** — where network studios prefer Belden over any other cable for picture-perfect quality and professional audio technicians demand Belden for crystal-clear audio quality.
- **Broadband CATV** — where Belden Duobond Plus® (Tri-shield) Cables have consistently outperformed the more elaborate quad-shielded cables.
- **Alarm/Security** — where Belden has been a favorite among installers for many years.

Now, these industry-leading and time-tested cables are available, along with many new innovations, for wiring the home of the 21st Century...only from Belden.

Better Designs, Better Performance

Some unique high performance technologies are used in the manufacture of these various cables, including:

Belden's Patented Data Cable Technology: Bonded-Pairs

To ensure top performance, Belden uses a unique manufacturing process that affixes the individual insulated conductors of the pairs along their longitudinal axis. This cable construction feature prevents gaps from occurring between the conductor pairs: a critical factor in the electrical performance of the cable.

Only Belden Bonded-Pair Data Cables Offer the Assurance of Installable Performance™

Due to the patented Bonded-Pair design, these cables are able to withstand the rigors of a typical installation without any degradation in performance. This means that the Cat 5e cable that you purchase from Belden to meet Cat 5e specifications will not only meet these specifications before installation, but more importantly, it will meet them after installation.

Coax Cables with Belden's Exclusive Duobond Plus® Shielding

Duobond Plus consists of a Duofoil® II (foil tape) surrounded by an 80 percent braid and an outer layer of foil with a unique shorting fold. This unique construction provides optimum shielding effectiveness.

Composite Cables — Without a Jacket!

Belden Banana Peel® composite cables feature a patent-pending design that eliminates the need for an overall jacket, making these cables easy to handle, easy to identify, easy to pull and easy to terminate. Just peel the cables off the center spline, and you're in business.

Everything You Need For The Intelligent Home

These structured cabling products for the Intelligent Home are all brought to you by Belden — the most innovative and trusted manufacturer in the cable industry. Belden offers the most comprehensive, time-tested and proven products for cabling the home.

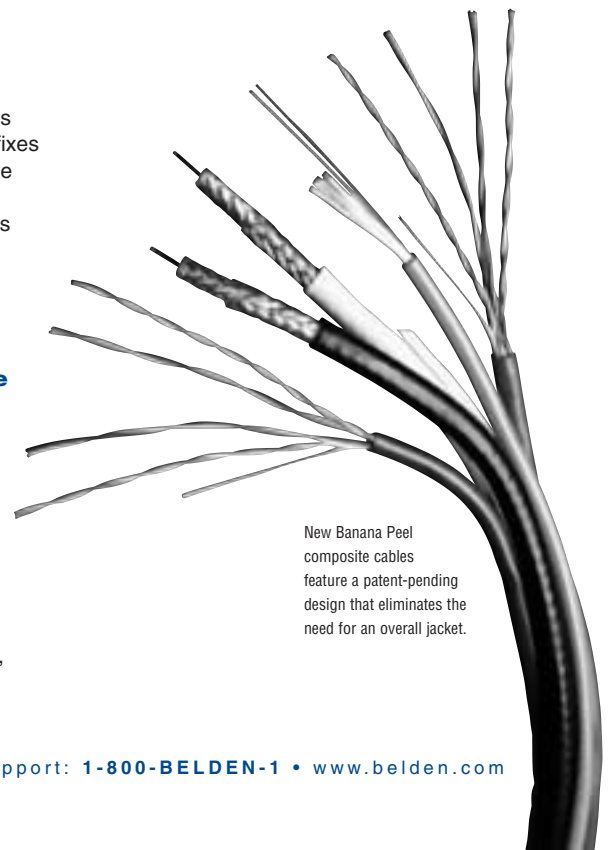

New Banana Peel composite cables feature a patent-pending design that eliminates the need for an overall jacket.

Composite Data, Audio, Video, Security and Control Cable

Banana Peel® Jacketless Cables

Category 5e Bonded-Pairs

Description	Part No.	UL NEC/ C(UL) CEC Type	Standard Lengths		Standard Unit Weight		Overall Nom. OD		Component Descriptions	Shielding Materials & Nom. DCR	Insulation Material & Color Code	Component Jacket Material & Colors	Component Nom. OD	
			Ft.	m	Lbs.	kg	Inch	mm					Inch	mm

Composite • (2) Cat 5e 4-Bonded-Pair UTP 24 AWG • (2) Series 6 Coax w/Duobond Plus® (Bonded Tri-Shield)

Polyolefin Insulation (Pairs) • Gas-injected FPE Insulation (Coax) • F-R PVC Jackets • No Overall Jacket													
7876S	NEC:	500	152.4	63.0	28.6	.550	13.97	(2) 4-Pair UTP Data Cables: Cat 5e Bonded-Pairs 24 AWG (solid) Bare Copper Cond. (1700R style)	None	Polyolefin (see chart below)	F-R PVC (1) Blue (1) Green	.204	5.18
	CEC:	1000	304.8	119.0	54.0								
	CMG FT4							(2) Coax: Series 6 18 AWG (solid) Bare Copper Cond. (7915A style)	Duobond Plus (Bonded Tri-Shield): Duobond® + 77% AL Braid + AL Foil w/ Shorting Fold	Gas-injected Foam Polyethylene	F-R PVC (1) Black (1) White	.275	6.99

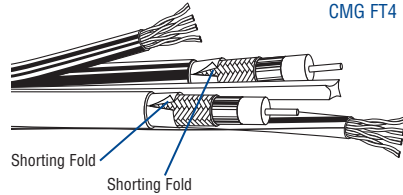

U.S. Patents 7,049,523; 5,606,151; 5,734,126.
Third party verified to TIA/EIA-568-B.2, Category 5e
Coax sweep tested to 3.0 GHz and jacket sequentially marked.
Coax shield effectiveness 125dB @ 1GHz is better than Quad shield.

Composite • (2) Cat 5e 4-Bonded-Pair UTP 24 AWG • (2) Series 6 Coax w/Duobond Plus • (1) 2-Fiber LANLite®

Polyolefin Insulation (Pairs) • Gas-injected FPE Insulation (Coax) • F-R PVC Jackets • No Overall Jacket													
7878S	NEC:	500	152.4	71.5	32.4	.595	15.11	(2) 4-Pair UTP Data Cables: Cat 5e Bonded-Pairs 24 AWG (solid) Bare Copper Cond. (1700R style)	None	Polyolefin (see chart below)	F-R PVC (1) Blue (1) Green	.204	5.18
	CEC:	1000	304.8	137.0	62.1								
	CMG OF FT4							(2) Coax: Series 6 18 AWG (solid) Bare Copper Cond. (7915A style)	Duobond Plus (Bonded Tri-Shield): Duobond + 77% AL Braid + AL Foil w/ Shorting Fold	Gas-injected Foam Polyethylene	F-R PVC (1) Black (1) White	.275	6.99
								(1) 2-Fiber LANLite: Gigabit Ethernet 62.5µ/125µ/900µ (core/clad/coating) Tight Buffered	None	PVC (1) Blue (1) Orange	F-R PVC (1) Orange	.175	4.45

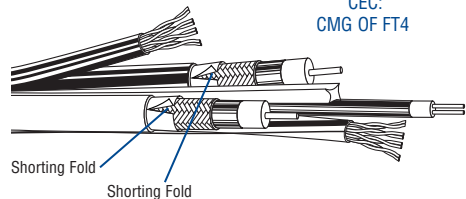

U.S. Patents 7,049,523; 5,606,151; 5,734,126.
Third party verified to TIA/EIA-568-B.2, Category 5e
Coax sweep tested to 3.0 GHz and jacket sequentially marked.
Coax shield effectiveness 125dB @ 1GHz is better than Quad shield.

AL = Aluminum • BC = Bare Copper • DCR = DC Resistance • FPE = Foam Polyethylene • F-R = Flame-retardant • UTP = Unshielded Twisted Pair

Contact the Belden Customer Service Department for a Comprehensive Connector Cross Reference: **1-800-BELDEN-1**.
Request quotations of cables not listed.

Color Codes: Cat 5e UTP

Pair No.	Color Combination
1	White/Blue Stripe & Blue
2	White/Orange Stripe & Orange
3	White/Green Stripe & Green
4	White/Brown Stripe & Brown



Composite Data, Audio, Video, Security and Control Cable

Banana Peel® Jacketless Cables

Category 5e

Description	Part No.	UL NEC/ C(UL) CEC Type	Standard Lengths		Standard Unit Weight		Overall Nom. OD		Component Descriptions	Shielding Materials & Nom. DCR	Insulation Material & Color Code	Component Jacket Material & Colors	Component Nom. OD	
			Ft.	m	Lbs.	kg	Inch	mm					Inch	mm

Composite • (1) Cat 5e 4-Pair UTP 24 AWG • (2) Series 6 Coax w/Duobond® IV* Quad Shield

Polyolefin Insulation (Pairs) • Gas-injected FPE Insulation (Coax) • PVC Jackets • No Overall Jacket

7956S <small>new</small>	NEC:	500	152.4	59.0	26.8	.596	15.14	(2) 4-Pair UTP Data Cables: Cat 5e 24 AWG (solid) BC Cond. (1583R style)	None	Polyolefin (see chart below)	PVC (1) Blue (1) Green	.194	4.93
	CEC: CMR CMG FT4	1000	304.8	112.0	50.8								
	(2) Coax: Series 6 18 AWG (solid) BC Cond. (7916A style)	Duobond IV Quad Shield: 60% & 40% AL Braids 4.8Ω/M' 15.7Ω/km	Gas-injected Foam Polyethylene	PVC (1) Black (1) White	.298	7.57							



U.S. Patent 7,049,523.
Third party verified to TIA/EIA-568-B.2, Category 5e.
Coax shield effectiveness 110dB @ 1GHz.
Coax sweep tested to 3.0 GHz and jacket sequentially marked.

Composite • (2) Cat 5e 4-Pair UTP 24 AWG • (2) Series 6 Coax w/Duobond® IV* Quad Shield

Polyolefin Insulation (Pairs) • Gas-injected FPE Insulation (Coax) • F-R PVC Jackets • No Overall Jacket

7913S	NEC:	500	152.4	68.5	31.1	.600	15.24	(2) 4-Pair UTP Data Cables: Cat 5e 24 AWG (solid) BC Cond. (1583R style)	None	Polyolefin (see chart below)	F-R PVC (1) Blue (1) Green	.194	4.93
	CEC: CMR CMG FT4	1000	304.8	130.0	59.0								
	(2) Coax: Series 6 18 AWG (solid) BC Cond. (7916A style)	Duobond IV Quad Shield: 60% & 40% AL Braids 4.8Ω/M' 15.7Ω/km	Gas-injected Foam Polyethylene	F-R PVC (1) Black (1) White	.298	7.57							

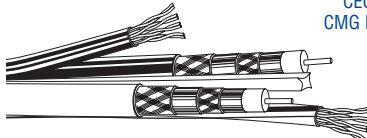

U.S. Patent 7,049,523.
Third party verified to TIA/EIA-568-B.2, Category 5e.
Coax shield effectiveness 110dB @ 1GHz.
Coax sweep tested to 3.0 GHz and jacket sequentially marked.

Composite • (2) Cat 5e 4-Pair UTP 24 AWG • (2) Series 6 Coax w/Duobond® IV* Quad Shield • (1) 2-Fiber LANLite®

Polyolefin Insulation (Pairs) • Gas-injected FPE Insulation (Coax) • F-R PVC Jackets • No Overall Jacket

7914S	NEC:	500	152.4	77.0	34.9	.625	15.88	(2) 4-Pair UTP Data Cables: Cat 5e 24 AWG (solid) BC Cond. (1583R style)	None	Polyolefin (see chart below)	F-R PVC (1) Blue (1) Green	.194	4.93
	CEC: CMR OF CMG OF FT4	1000	304.8	148.0	67.1								
	(2) Coax: Series 6 18 AWG (solid) BC Cond. (7916A style)	Duobond IV Quad Shield: 60% & 40% AL Braids 4.8Ω/M' 15.7Ω/km	Gas-injected Foam Polyethylene	F-R PVC (1) Black (1) White	.298	7.57							
	(1) 2-Fiber LANLite: Gigabit Ethernet 62.5µ/125µ/900µ (core/clad/coating) Tight Buffered	None	PVC (1) Blue (1) Orange	F-R PVC (1) Orange	.175	4.45							

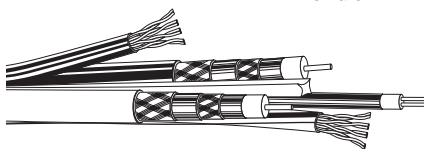

U.S. Patent 7,049,523.
Third party verified to TIA/EIA-568-B.2, Category 5e.
Coax shield effectiveness 110dB @ 1GHz.
Coax sweep tested to 3.0 GHz and jacket sequentially marked.

AL = Aluminum • BC = Bare Copper • DCR = DC Resistance • FPE = Foam Polyethylene • F-R = Flame-retardant • UTP = Unshielded Twisted Pair

Contact the Belden Customer Service Department for a Comprehensive Connector Cross Reference: **1-800-BELDEN-1**. Request quotations of cables not listed.

* Duobond IV = Duobond II + 60% aluminum braid + Duofoil® + 40% aluminum braid.

Color Codes: Cat 5e UTP

Pair No.	Color Combination
1	White/Blue Stripe & Blue
2	White/Orange Stripe & Orange
3	White/Green Stripe & Green
4	White/Brown Stripe & Brown

Composite Data, Audio, Video, Security and Control Cable

Jacketed Cables

Category 5e Bonded-Pairs

Description	Part No.	UL NEC/ C(UL) CEC Type	Standard Lengths		Standard Unit Weight		Overall Nom. OD		Component Descriptions	Shielding Materials & Nom. DCR	Insulation Material & Color Code	Component Jacket Material & Colors	Component Nom. OD	
			Ft.	m	Lbs.	kg	Inch	mm					Inch	mm

Composite • (1) Cat 5e 4-Bonded-Pair UTP 24 AWG • (1) Series 6 Coax w/Duobond Plus® Bonded Tri-Shield

Polyolefin Insulation (Pairs) • Gas-injected FPE Insulation (Coax) • F-R PVC Jackets • Overall Green F-R PVC Jacket

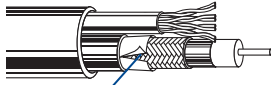
7910A	NEC:	500	152.4	48.5	22.0	.335	8.51	(1) 4-Pair UTP Data Cable: Cat 5e Bonded-Pairs 24 AW (solid) BC Cond. (1700R style)	None	Polyolefin (see chart below)	F-R PVC (1) Blue	.200	5.08
	CEC: CMG FT4	1000	304.8	91.0	41.3	x	x						
								(1) Coax: Series 6 18 AWG (solid) Bare Copper Cond. (7915A style)	Duobond Plus Bonded Tri-Shield: Duobond® + 77% AL Braid + AL Foil w/ Shorting Fold	Gas-injected Foam Polyethylene	F-R PVC (1) Black	.275	6.99

Shorting Fold

Third party verified to TIA/EIA-568-B.2, Category 5e
Coax sweep tested to 3.0 GHz and jacket sequentially marked.
Coax shield effectiveness 125dB @ 1GHz is better than Quad shield.

Composite • (2) Cat 5e 4-Bonded-Pair UTP • (2) Series 6 Coax w/Duobond Plus Bonded Tri-Shield

Polyolefin Insulation (Pairs) • Gas-injected FPE Insulation (Coax) • F-R PVC Jackets • Overall Green F-R PVC Jacket

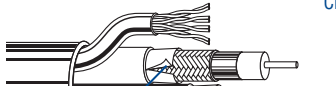
7876A	NEC:	500	152.4	77.0	35.0	.610	15.49	(2) 4-Pair UTP Data Cables: Cat 5e Bonded-Pairs 24 AWG (solid) BC Cond. (1700R style)	None	Polyolefin (see chart below)	F-R PVC (1) Blue (1) Green	.200	5.08
	CEC: CMG FT4	1000	304.8	148.0	67.2								
								(2) Coax: Series 6 18 AWG (solid) Bare Copper Cond. (7915A style)	Duobond Plus Bonded Tri-Shield: Duobond + 77% AL Braid + AL Foil w/ Shorting Fold	Gas-injected Foam Polyethylene	F-R PVC (1) Black (1) White	.275	6.99

Shorting Fold

Third party verified to TIA/EIA-568-B.2, Category 5e
Coax sweep tested to 3.0 GHz and jacket sequentially marked.
Coax shield effectiveness 125dB @ 1GHz is better than Quad shield.

Composite • (1) Cat 5e 4-Bonded-Pair UTP • (2) Series 6 Coax w/Duobond Plus Bonded Tri-Shield

Polyolefin Insulation (Pairs) • Gas-injected FPE Insulation (Coax) • F-R PVC Jackets • Overall Green F-R PVC Jacket

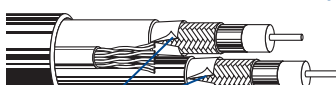
7877A	NEC:	500	152.4	67.0	30.5	.610	15.49	(1) 4-Pair UTP Data Cable: Cat 5e Bonded-Pairs 24 AWG (solid) BC Cond. (1700R style)	None	Polyolefin (see chart below)	F-R PVC (1) Blue	.200	5.08
	CEC: CMG FT4	1000	304.8	128.0	58.2								
								(2) Coax: Series 6 18 AWG (solid) Bare Copper Cond. (7915A style)	Duobond Plus Bonded Tri-Shield: Duobond + 77% AL Braid + AL Foil w/ Shorting Fold	Gas-injected Foam Polyethylene	F-R PVC (1) Black (1) White	.275	6.99

Shorting Fold

Third party verified to TIA/EIA-568-B.2, Category 5e
Coax sweep tested to 3.0 GHz and jacket sequentially marked.
Coax shield effectiveness 125dB @ 1GHz is better than Quad shield.

AL = Aluminum • BC = Bare Copper • DCR = DC Resistance • FPE = Foam Polyethylene • F-R = Flame-retardant • UTP = Unshielded Twisted Pair

Contact the Belden Customer Service Department for a Comprehensive Connector Cross Reference: **1-800-BELDEN-1**.
Request quotations of cables not listed.

Color Codes: Cat 5e UTP

Pair No.	Color Combination
1	White/Blue Stripe & Blue
2	White/Orange Stripe & Orange
3	White/Green Stripe & Green
4	White/Brown Stripe & Brown

Composite Data, Audio, Video, Security and Control Cable

Jacketed Cables

Category 5e Bonded-Pairs and Category 5

Description	Part No.	UL NEC/ C(UL) CEC Type	Standard Lengths		Standard Unit Weight		Overall Nom. OD		Component Descriptions	Shielding Materials & Nom. DCR	Insulation Material & Color Code	Component Jacket Material & Colors	Component Nom. OD	
			Ft.	m	Lbs.	kg	Inch	mm					Inch	mm

Composite • (2) Cat 5e 4-Bonded-Pair UTP 24 AWG • (2) Series 6 Coax w/Duobond Plus® Tri-Shield • (1) 2-Fiber LANLite®

Polyolefin Insulation (Pairs) • Gas-injected FPE Insulation (Coax) • F-R PVC Jackets • Overall Green F-R PVC Jacket

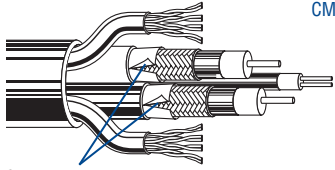
 <p>Shorting Fold</p>	7878A	NEC: CMR OF CEC: CMG OF FT4	500 1000	152.4 304.8	84.0 162.0	34.2 73.5	.635	16.13	(2) 4-Pair UTP Data Cables: Cat 5e Bonded-Pairs 24 AWG (solid) BC Cond. (1700R style)	None	Polyolefin (see chart below)	F-R PVC (1) Blue (1) Green	.200	5.08
									(2) Coax: Series 6 18 AWG (solid) Bare Copper Cond. (7915A style)	Duobond Plus Bonded Tri-Shield: Duobond® + 77% AL Braid + AL Foil w/ Shorting Fold 4.6Ω/M'	Gas-injected Foam Polyethylene	F-R PVC (1) Black (1) White	.275	6.99
									(1) 2-Fiber LANLite: Gigabit Ethernet 62.5μ/125μ/900μ (core/clad/coating) Tight Buffered	None	PVC (1) Blue (1) Orange	F-R PVC (1) Orange	.175	4.45

Third party verified to TIA/EIA-568-B.2, Category 5e
Coax sweep tested to 3.0 GHz and jacket sequentially marked.
Coax shield effectiveness 125dB @ 1GHz is better than Quad shield.

Composite • (2) Cat 5 4-Pair UTP 24 AWG • (2) Series 6 Coax w/Duobond IV* Quad Shield

Polyolefin Insulation (Pairs) • Gas-injected FPE Insulation (Coax) • F-R PVC Jackets • Overall Green F-R PVC Jacket

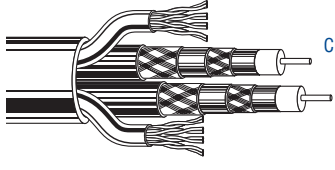
	7913A	NEC: CMR CEC: CMG FT4	500 1000	152.4 304.8	82.0 157.0	37.2 71.3	.660	16.76	(2) 4-Pair UTP Data Cables: Cat 5e 24 AWG (solid) BC Cond. (1583R style)	None	Polyolefin (see chart below)	F-R PVC (1) Blue (1) Green	.195	4.95
									(2) Coax: Series 6 18 AWG (solid) BC Cond. (7916A style)	Duobond IV Quad Shield: 60% & 40% AL Braids 4.8Ω/M'	Gas-injected Foam Polyethylene	F-R PVC (1) Black (1) White	.298	7.57

Third party verified to TIA/EIA-568-B.2, Category 5e
Coax sweep tested to 3.0 GHz and jacket sequentially marked.
Coax shield effectiveness 110dB @ 1GHz.

Composite • (2) Cat 5 4-Pair UTP 24 AWG • (2) Series 6 Coax w/Duobond IV* Quad Shield • (1) 2-Fiber LANLite

Polyolefin Insulation (Pairs) • Gas-injected FPE Insulation (Coax) • F-R PVC Jackets • Overall Green F-R PVC Jacket

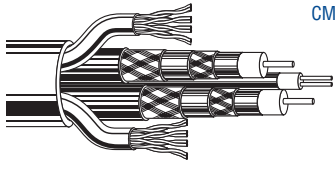
	7914A	NEC: CMR OF CEC: CMG OF FT4	500 1000	152.4 304.8	88.0 169.0	40.0 76.7	.660	16.76	(2) 4-Pair UTP Data Cables: Cat 5e 24 AWG (solid) BC Cond. (1583R style)	None	Polyolefin (see chart below)	F-R PVC (1) Blue (1) Green	.195	4.95
									(2) Coax: Series 6 18 AWG (solid) BC Cond. (7916A style)	Duobond IV Quad Shield: 60% & 40% AL Braids 4.8Ω/M'	Gas-injected Foam Polyethylene	F-R PVC (1) Black (1) White	.298	7.57
									(1) 2-Fiber LANLite: Gigabit Ethernet 62.5μ/125μ/900μ (core/clad/coating) Tight Buffered	None	PVC (1) Blue (1) Orange	F-R PVC (1) Orange	.175	4.45

Third party verified to TIA/EIA-568-B.2, Category 5e
Coax sweep tested to 2.25 GHz and jacket sequentially marked.
Coax shield effectiveness 110dB @ 1GHz.

AL = Aluminum • BC = Bare Copper • DCR = DC Resistance • FPE = Foam Polyethylene • F-R = Flame-retardant • UTP = Unshielded Twisted Pair

Contact the Belden Customer Service Department for a Comprehensive Connector Cross Reference: **1-800-BELDEN-1**.
Request quotations of cables not listed.

* Duobond IV = Duobond II + 60% aluminum braid + Duofoil® + 40% aluminum braid.

Color Code: Cat 5e UTP

Pair No.	Color Combination
1	White/Blue Stripe & Blue
2	White/Orange Stripe & Orange
3	White/Green Stripe & Green
4	White/Brown Stripe & Brown

Composite Data, Audio, Video, Security and Control Cable

Siamese Cables

Category 5e Bonded-Pairs and Category 5

Description	Part No.	UL NEC/ C(UL) CEC Type	Standard Lengths		Standard Unit Weight		Overall Nom. OD		Component Descriptions	Shielding Materials & Nom. DCR	Insulation Material & Color Code
			Ft.	m	Lbs.	kg	Inch	mm			

Composite • (1) Cat 5e 4-Bonded-Pair UTP 24 AWG • (1) Series 6 Coax w/Duobond Plus® Bonded Tri-Shield

Polyolefin Insulation (Pairs) • Gas-injected FPE Insulation (Coax) • Overall Green F-R PVC Jacket

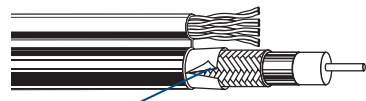
Siamese Construction	7911A	NEC: CMR CEC: CMG FT4	500 1000	152.4 304.8	35.0 60.0	15.9 27.2	.275 x .529	6.99 x 13.44	(1) 4-Pair UTP Data Cables: Cat 5e Bonded-Pairs 24 AWG (solid) BC Cond. (1700R style)	None	Polyolefin (see chart below)
											
									(1) Coax: Series 6 18 AWG (solid) Bare Copper Cond. (7915A style)	Duobond Plus Bonded Tri-Shield: Duobond® + 77% AL Braid + AL Foil w/ Shorting Fold 4.6Ω/M'	Gas-injected Foam Polyethylene

Shorting Fold

Third party verified to TIA/EIA-568-B.2, Category 5e
Coax sweep tested to 3.0 GHz and jacket sequentially marked.
Coax shield effectiveness 125dB @ 1GHz is better than Quad shield.

Composite • (1) Cat 5 4-Pair UTP 24 AWG • (1) Series 6 Coax w/Duobond IV* Quad Shield

Polyolefin Insulation (Pairs) • Gas-injected FPE Insulation (Coax) • Overall Green F-R PVC Jacket

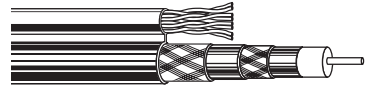
Siamese Construction	7912A	NEC: CMR CEC: CMG FT4	500 1000	152.4 304.8	37.5 65.0	17.0 29.5	.297 x .543	7.54 x 13.79	(1) 4-Pair UTP Data Cables: Cat 5e 24 AWG (solid) BC Cond. (1583R style)	None	Polyolefin (see chart below)
											
									(1) Coax: Series 6 18 AWG (solid) AL Braids BC Cond. (7916A style)	Duobond IV Quad Shield: 60% & 40% AL Braids 4.8Ω/M'	Gas-injected Foam Polyethylene

Third party verified to TIA/EIA-568-B.2, Category 5e
Coax sweep tested to 3.0 GHz and jacket sequentially marked.
Coax shield effectiveness 110dB @ 1GHz.

Composite • (1) Cat 5 4-Pair UTP 24 AWG • (1) Series 6 Coax w/Duobond II* Foil + Braid Shield

Polyolefin Insulation (Pairs) • Gas-injected Foam HDPE Insulation (Coax) • Overall Green F-R PVC Jacket

Siamese Construction	7917A	NEC: CM CEC: CM	1000	304.8	55.0	25.0	.273 x .504	6.93 x 12.80	(1) 4-Pair UTP Data Cables: Cat 5e 24 AWG (solid) BC Cond. (1583R style)	None	Polyolefin (see chart below)
											
									(1) Coax: Series 6 18 AWG (solid) Bare Copper Cond.	Duobond II: Bonded Foil (100%) + AL Braid (57%) 9.0Ω/M'	Gas-injected Foam High-density Polyethylene

Third party verified to TIA/EIA-568-B.2, Category 5e
Coax sweep tested to 3.0 GHz and jacket sequentially marked.

AL = Aluminum • BC = Bare Copper • DCR = DC Resistance • FPE = Foam Polyethylene • F-R = Flame-retardant • HDPE = High-Density Polyethylene • UTP = Unshielded Twisted Pair

Contact the Belden Customer Service Department for a Comprehensive Connector Cross Reference: **1-800-BELDEN-1**.
Request quotations of cables not listed.

* Duobond IV = Duobond II + 60% aluminum braid + Duofoil® + 40% aluminum braid.

Color Code: Cat 5e UTP

Pair No.	Color Combination
1	White/Blue Stripe & Blue
2	White/Orange Stripe & Orange
3	White/Green Stripe & Green
4	White/Brown Stripe & Brown



Composite Data, Audio, Video, Security and Control Cable

Keypad and Control Cables

Category 5e Bonded-Pairs and Category 5

Description	Part No.	UL NEC/ C(UL) CEC Type	Standard Lengths		Standard Unit Weight		Overall Nom. OD		Component Descriptions	Shielding Materials & Nom. DCR	Insulation Material & Color Code	Component Jacket Material & Colors	Component Nom. OD	
			Ft.	m	Lbs.	kg	Inch	mm					Inch	mm

Composite • (1) STP (Data) 22 AWG (7x30) TC Cond. w/Beldfoil®, Drain Wire • **(2) TC Conductors** (Power) 18 AWG (16x30) Unshielded

HDFPE Insulation (Data Pair) • **F-R PVC Insulation** (Power Cond.) • **F-R PVC Jacket** (Available in Black, White or Aqua)

300V 75°C	1502R	NEC: CMR CEC: CMG FT4	500 1000	152.4 304.8	20.0 44.0	9.1 20.0	.250 6.35		Data: (1) Twisted Pair 22 AWG (7x30) TC Cond.	Beldfoil® Shield (100%)	HDFPE Blue, White	F-R PVC	N/A	N/A
								(2) Power Cond.: 18 AWG (16x30) TC Cond.	None	FR-PVC Red, Black	—	N/A	N/A	

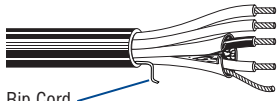

Rip Cord

Sequential footing marking every two feet.

Composite • (1) Cat 5e 4-Bonded-Pair UTP 24 AWG • **(4) 16 AWG Bare Copper Conductors** Stranded (19x29)

Polyolefin Insulation (Pairs) • **PVC Insulation** (Conductors) • **Overall Green F-R PVC Jacket**

	7949A	NEC: CMR CEC: CMG FT4	500 1000	152.4 304.8	54.5 99.0	24.7 44.9	.355 9.02		(1) 4-Pair UTP Data Cable: Bonded-Pairs 24 AWG (solid) BC Cond.	None	Polyolefin (see chart below)	F-R PVC (1) Blue	.200	5.08
								(4) Conductors: 16 AWG (19x29) BC Cond.	None	PVC Red, White, Green, Black	—	.079	2.01	

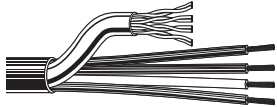

Jacket sequentially marked.
Third party verified to TIA/EIA-568-B.2, Category 5e

Composite • (1) Cat 5 4-Pair UTP 24 AWG • **(4) 16 AWG Bare Copper Conductors** Stranded (19x29)

Polyolefin Insulation (Pairs) • **PVC Insulation** (Conductors) • **Overall Green F-R PVC Jacket**

	7950A	NEC: CMR CEC: CMG FT4	500 1000	152.4 304.8	54.0 98.0	24.5 44.5	.390 9.91		(1) 4-Pair UTP Data Cable: 24 AWG (solid) BC Cond.	None	Polyolefin (see chart below)	F-R PVC (1) Blue	.195	4.95
								(4) Conductors: 16 AWG (19x29) BC Cond.	None	PVC Red, White, Green, Black	—	.079	2.01	

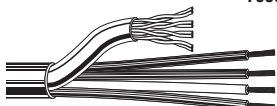

Jacket sequentially marked.
Third party verified to TIA/EIA-568-B.2, Category 5

Composite • (1) Cat 5 4-Pair UTP 24 AWG • **(4) 18 AWG Bare Copper Conductors** Stranded (19x30)

Polyolefin Insulation (Pairs) • **PVC Insulation** (Conductors) • **Overall Green F-R PVC Jacket**

	7951A	NEC: CMR CEC: CMG FT4	500 1000	152.4 304.8	49.0 88.0	22.2 39.9	.407 10.34		(1) 4-Pair UTP Data Cable: 24 AWG (solid) BC Cond.	None	Polyolefin (see chart below)	F-R PVC (1) Blue	.195	4.95
								(4) Conductors: 18 AWG (19x30) BC Cond.	None	PVC Red, White, Green, Black	—	.066	1.68	

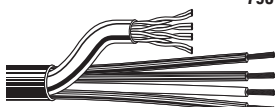

Jacket sequentially marked.
Third party verified to TIA/EIA-568-B.2, Category 5

Composite • (1) Cat 5 4-Pair UTP 24 AWG • **(4) 14 AWG Bare Copper Conductors** Stranded (19x26)

Polyolefin Insulation (Pairs) • **PVC Insulation** (Conductors) • **Overall Green F-R PVC Jacket**

Siamese Construction	7952A	NEC: CMR CEC: CMG FT4	500	152.4	58.0	26.3	.289 7.34	.289 7.34	(1) 4-Pair UTP Data Cable: 24 AWG (solid) BC Cond.	None	Polyolefin (see chart below)	F-R PVC (1) Blue	.216	5.49
							.535 13.59	.535 13.59	(4) Conductors: 14 AWG (19x26) BC Cond.	None	PVC Red, White, Green, Black	—	.99	25.15

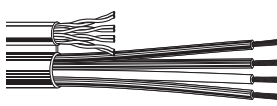

Jacket sequentially marked.
Third party verified to TIA/EIA-568-B.2, Category 5

BC = Bare Copper • DCR = DC Resistance • F-R = Flame-retardant • HDFPE = High-density Foam Polyethylene • STP = Shielded Twisted Pair • TC = Tinned Copper • UTP = Unshielded Twisted Pair

Contact the Belden Customer Service Department for a Comprehensive Connector Cross Reference: **1-800-BELDEN-1**.
Request quotations of cables not listed.

Color Code: Cat 5e UTP

Pair No.	Color Combination
1	White/Blue Stripe & Blue
2	White/Orange Stripe & Orange
3	White/Green Stripe & Green
4	White/Brown Stripe & Brown



Data and Voice Cable

Category 6 UTP Cables

Description	Part No.	UL NEC/ C(UL) CEC Type	No. of Pairs	Standard Lengths		Standard Unit Wt.		Nominal OD		Max. DCR (Ω/ 100m)	Max. DCR Unbal. (%)	Max. Cap. Unbal. (pF/ 100m)	Freq. (MHz)	Max. Atten. (dB/ 100m)	Min. PSUM NEXT (dB)	Min. PSUM ACR (dB/ 100m)	Min. PSUM ELFEXT (dB/ 100m)	Input Imped. (Ω)	Min. RL (dB)
				Ft.	m	Lbs.	kg	Inch	mm										

23 AWG Solid Bare Copper Conductors • Twisted Pairs • Central Rod Filler • Rip Cord • See Color Code Chart (below)

Non-Plenum • Polyolefin Insulation • PVC Jacket (Available in Red, Orange, Yellow, Green, Blue, Purple, Gray, White or Black)

75°C	7881A	NEC: CMR CEC: CMR FT4	4	1000	304.8	30.0	13.6	.235	5.97	8.2	5.0	330	1	2.0	72.3	70.3	64.8	100±15	20.0
				A-1000	A-304.8	33.0	15.0						10	6.0	57.3	51.3	44.8	100±15	25.0
													20	8.5	52.8	44.3	38.7	100±15	25.0
													31.25	10.7	49.9	39.2	34.9	100±15	23.6
													62.5	15.4	45.4	30.0	28.8	100±15	21.5
													100	19.8	42.3	22.5	24.8	100±15	20.1
													200	29.0	37.8	8.8	18.7	100±22	18.0
													250	32.8	36.3	3.5	16.8	100±32	17.3

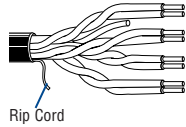

Jacket sequentially marked at 2 ft. intervals.
Third party verified to TIA/EIA-568-B.2-1, Category 6

Plenum • FRPO/FEP Insulation • Flamarrest® Jacket (Red, Orange, Yellow, Green, Blue, Purple, Gray, White, Natural or Black)

75°C	7882A	NEC: CMP CEC: CMP FT6	4	1000	304.8	29.0	13.2	.224	5.69	8.2	5.0	330	1	2.0	72.3	70.3	64.8	100±15	20.0
				A-1000	A-304.8	32.0	14.5						10	6.0	57.3	51.3	44.8	100±15	25.0
													20	8.5	52.8	44.3	38.7	100±15	25.0
													31.25	10.7	49.9	39.2	34.9	100±15	23.6
													62.5	15.4	45.4	30.0	28.8	100±15	21.5
													100	19.8	42.3	22.5	24.8	100±15	20.1
													200	29.0	37.8	8.8	18.7	100±22	18.0
													250	32.8	36.3	3.5	16.8	100±32	17.3

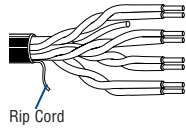

Jacket sequentially marked at 2 ft. intervals.
Third party verified to TIA/EIA-568-B.2-1, Category 6

ACR = Attenuation Crosstalk Ratio • DCR = DC Resistance • ELFEXT = Equal Level Far-end Crosstalk • FEP = Fluorinated Ethylene-Propylene • FRPO = Flame-retardant Polyolefin • NEXT = Near-end Crosstalk • PSUM = Power Sum • RL = Return Loss • UTP = Unshielded Twisted Pair(s)

For a complete selection of Belden® Data Cables, refer to the Commercial Networking: Copper section of this catalog.

Color Codes

Pair No.	Color Combination
1	White/Blue Stripe & Blue
2	White/Orange Stripe & Orange
3	White/Green Stripe & Green
4	White/Brown Stripe & Brown

Data and Voice Cable

Enhanced Category 5e UTP Cables

Description	Part No.	UL NEC/ C(UL) CEC Type	No. of Pairs	Standard Lengths		Standard Unit Wt.		Nominal OD		Max. DCR (Ω/100m)	Max. DCR Unbal. (%)	Max. Cap. Unbal. (pF/100m)	Freq. (MHz)	Max. Atten. (dB/100m)	Min. PSUM NEXT (dB)	Min. PSUM ACR (dB/100m)	Min. PSUM ELFEXT (dB/100m)	Input Imped. (Ω)	Min. RL (dB)
				Ft.	m	Lbs.	kg	Inch	mm										

24 AWG Bonded-Pairs Solid Bare Copper Conductors • Rip Cord • See Color Code Chart (below)

Non-Plenum • Polyolefin Insulation • PVC Jacket (Red, Orange, White, Yellow, Green, Blue, Purple, or Gray)

80°C	1700R	NEC: 4	U-1000	U-304.8	21.0	9.5	.204	5.18	9.0	3.0	66.0	1	2.0	65.3	63.3	60.8	100±12	20.0
		CMR	1000	304.8	22.0	10.0						4	4.0	56.3	52.3	48.7	100±12	23.0
		CEC: 3000 [▲]	914.4	63.0	28.6							8	5.7	51.8	46.1	42.7	100±12	24.5
		CMR FT4										10	6.4	50.3	43.9	40.8	100±12	25.0
												16	8.1	47.3	39.1	36.7	100±12	25.0
												25	10.3	44.3	34.1	32.8	100±15	24.3
												31.25	11.6	42.9	31.3	30.9	100±15	23.6
												62.5	16.8	38.4	21.6	24.8	100±15	21.5
												100	21.7	35.3	17.1	20.8	100±15	20.1
												155	27.7	32.5	4.7	16.9	100±18	19.0
												200	32.0	30.8	3.0	14.7	100±20	19.0
												250	36.4	29.3	—	12.8	100±20	18.0
												350	44.3	27.2	—	9.9	100±22	17.0

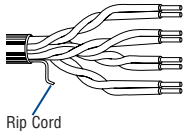

Jacket sequentially marked at 2 ft. intervals.
Third party verified to TIA/EIA-568-B.2, Category 5e • U.S. Patents 5,606,151 and 5,734,126
[▲]3000 ft. put-up not available in Orange, Yellow nor Green.

Tested to 350 MHz.

Plenum • FEP Insulation • Flamarrest® Jacket (Red, Orange, Yellow, Green, Blue, Purple, Gray, White, Natural or Black)

75°C	1701A	NEC: 4	U-1000	U-304.8	23.0	10.5	.193	4.90	9.0	3.0	66.0	1	2.0	65.3	63.3	60.8	100±12	20.0
		CMR	1000	304.8	24.0	10.9						4	4.0	56.3	52.3	48.7	100±12	23.0
		CEC: 3000 [♦]	914.4	69.0	31.3							8	5.7	51.8	46.1	42.7	100±12	24.5
		CMR FT6										10	6.4	50.3	43.9	40.8	100±12	25.0
												16	8.1	47.3	39.1	36.7	100±12	25.0
												25	10.3	44.3	34.1	32.8	100±15	24.3
												31.25	11.6	42.9	31.3	30.9	100±15	23.6
												62.5	16.8	38.4	21.6	24.8	100±15	21.5
												100	21.7	35.3	17.1	20.8	100±15	20.1
												155	27.7	32.5	4.7	16.9	100±18	19.0
												200	32.0	30.8	3.0	14.7	100±20	19.0
												250	36.4	29.3	—	12.8	100±20	18.0
												350	44.3	27.2	—	9.9	100±22	17.0

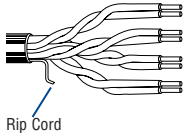

Jacket sequentially marked at 2 ft. intervals.
Third party verified to TIA/EIA-568-B.2, Category 5e • U.S. Patents 5,606,151 and 5,734,126
[♦]3000 ft. put-up available in Blue or Natural only.

Tested to 350 MHz.

24 AWG Solid Bare Copper Conductors • Twisted Pairs • Rip Cord • See Color Code Chart (below)

Non-Plenum • Polyolefin Insulation • PVC Jacket (Available in Red, Orange, Yellow, Green, White, Blue or Gray)

80°C	1500R	NEC: 4	1000	304.8	24.0	10.9	.194	4.93	9.0	3.0	66.0	1	2.0	65.3	63.3	60.8	100±12	20.0
		CMR	A-1000	A-304.8	27.0	12.3						4	4.0	56.3	52.3	48.7	100±12	23.0
		CEC: 3000 [♦]										8	5.7	51.8	46.1	42.7	100±12	24.5
		CMR FT4										10	6.4	50.3	43.9	40.8	100±12	25.0
												16	8.1	47.3	39.1	36.7	100±12	25.0
												25	10.3	44.3	34.1	32.8	100±15	24.3
												31.25	11.6	42.9	31.3	30.9	100±15	23.6
												62.5	16.8	38.4	21.6	24.8	100±15	21.5
												100	21.7	35.3	17.1	20.8	100±15	20.1
												155	27.7	32.5	4.7	16.9	100±18	19.0
												200	32.0	30.8	3.0	14.7	100±20	19.0
												250	36.4	29.3	—	12.8	100±20	18.0
												350	44.3	27.2	—	9.9	100±22	17.0

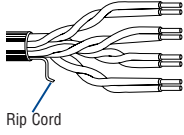

Jacket sequentially marked at 2 ft. intervals.
Third party verified to TIA/EIA-568-B.2, Category 5e

Tested to 350 MHz.

ACR = Attenuation Crosstalk Ratio • DCR = DC Resistance • ELFEXT = Equal Level Far-end Crosstalk • FEP = Fluorinated Ethylene-Propylene • NEXT = Near-end Crosstalk • PSUM = Power Sum • RL = Return Loss • UTP = Unshielded Twisted Pair(s)

For a complete selection of Belden® Data Cables, refer to the Commercial Networking: Copper section of this catalog.

Color Codes

Pair No.	Color Combination
1	White/Blue Stripe & Blue
2	White/Orange Stripe & Orange
3	White/Green Stripe & Green
4	White/Brown Stripe & Brown



Data and Voice Cable

Category 5e UTP Cables

Description	Part No.	UL NEC/ C(UL) CEC Type	No. of Pairs	Standard Lengths		Standard Unit Wt.		Nominal OD		Max. DCR (Ω / 100m)	Max. DCR Unbal. (%)	Max. Cap. Unbal. (pF/ 100m)	Freq. (MHz)	Max. Atten. (dB/ 100m)	Min. PSUM NEXT (dB)	Min. PSUM ACR (dB/ 100m)	Min. PSUM ELFEXT (dB/ 100m)	Input Imped. (Ω)	Min. RL (dB)
				Ft.	m	Lbs.	kg	Inch	mm										

24 AWG Solid Bare Copper Conductors • Twisted Pairs • Rip Cord • See Color Code Chart (below)

Non-Plenum • Polyolefin Insulation • PVC Jacket (Available in Red, Orange, Yellow, Green, Blue, Gray, White or Pink)

80°C	1583R	NEC: CMR CEC: CMR FT4	4	U-1000 1000 3000*	U-304.8 304.8 914.4	23.0 22.0 63.0	10.5 10.0 28.6	.195	4.95	9.38	3.0	330	1 4 10 16 31.25 62.5 100 200	2.0 4.1 6.5 8.2 11.7 17.0 22.0 32.0	62.3 53.3 47.3 44.3 39.9 35.4 32.3 27.8	60.0 49.0 41.0 36.0 28.0 19.0 11.0 1.0	60.8 48.7 40.8 36.7 30.9 24.8 20.8 14.7	100±15 100±15 100±15 100±15 100±15 100±15 100±15 100±25	20.0 23.0 25.0 25.0 23.6 21.5 20.1 15.0
------	-------	--------------------------------	---	-------------------------	---------------------------	----------------------	----------------------	------	------	------	-----	-----	---	--	--	---	--	--	--

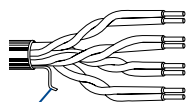

Rip Cord

Jacket sequentially marked at 2 ft. intervals.

Third party verified to TIA/EIA-568-B.2, Category 5e

*3000 ft. put-ups available in Gray, White or Blue only.

Plenum • FRPO/FEP Insulation • Flamarrest® Jacket (Red, Orange, Yellow, Green, Blue, Gray, White, Natural, Black or Pink)

75°C	1585A	NEC: CMP CEC: CMP FT6	4	U-1000 1000 3000*	U-304.8 304.8 914.4	23.0 24.0 69.0	10.5 10.9 31.4	.195	4.95	9.38	3.0	330	1 4 10 16 31.25 62.5 100 200	2.0 4.1 6.5 8.2 11.7 17.0 22.0 32.0	62.3 53.3 47.3 44.3 39.9 35.4 32.3 27.8	60.0 49.0 41.0 36.0 28.0 19.0 11.0 1.0	60.8 48.7 40.8 36.7 30.9 24.8 20.8 14.7	100±15 100±15 100±15 100±15 100±15 100±15 100±15 100±25	20.0 23.0 25.0 25.0 23.6 21.5 20.1 15.0
------	-------	--------------------------------	---	-------------------------	---------------------------	----------------------	----------------------	------	------	------	-----	-----	---	--	--	---	--	--	--

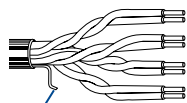

Rip Cord

Jacket sequentially marked at 2 ft. intervals.

Third party verified to TIA/EIA-568-B.2, Category 5e

*3000 ft. put-up available in Natural or Blue only.

ACR = Attenuation Crosstalk Ratio • DCR = DC Resistance • ELFEXT = Equal Level Far-end Crosstalk • FEP = Fluorinated Ethylene-Propylene • FRPO = Flame-retardant Polyolefin • NEXT = Near-end Crosstalk • PSUM = Power Sum • RL = Return Loss • UTP = Unshielded Twisted Pair(s)

For a complete selection of Belden® Data Cables, refer to the Commercial Networking: Copper section of this catalog.

Color Codes

Pair No.	Color Combination
1	White/Blue Stripe & Blue
2	White/Orange Stripe & Orange
3	White/Green Stripe & Green
4	White/Brown Stripe & Brown

Video/RF Cable

Broadband CATV and DBS Coaxial Cables

Series 6 (RG-6/U Type)

Description	Part No.	UL NEC/ C(UL) CEC Type	Standard Lengths		Standard Unit Weight		Conductor (stranding) Diameter Nom. DCR	Nominal Core OD		Shielding Materials Nom. DCR	Nominal OD		Nom. Imp. (Ω)	Nom. Vel. of Prop.	Nominal Capacitance		Nominal Attenuation		
			Ft.	m	Lbs.	kg		Inch	mm		Inch	mm			pF/Ft.	pF/m	MHz	dB/ 100 Ft.	dB/ 100m

Series 6 • 18 AWG Solid .040" Bare Copper Conductor • Duobond® + Aluminum Braid(s) Shield

Gas-injected Foam Polyethylene Insulation • PVC Jacket (Available in Black or White)

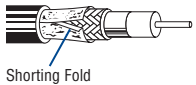
 <p>Shorting Fold</p>	80°C	7915A	NEC:	U-500	U-152.4	16.5	7.5	18 AWG	.180	4.57	Duobond Plus [®] +	.275	6.99	75	83%	16.2	53.2	5	.5	1.6	
			CATV CM	500	152.4	18.0	8.2	(solid)											55	1.4	4.6
			CEC:	U-1000	U-304.8	31.0	14.1	.040"			77% & 80%								211	2.6	8.5
			CM	1000	304.8	31.0	14.1	BC			Aluminum Braid								500	4.1	13.5
								6.4Ω/M'											750	5.1	16.7
								21.0Ω/km											862	5.5	18.0
																			1000	6.0	19.7
																			1450	7.8	25.6
																			1800	8.4	27.6
																			2250	9.8	32.2

Shielding effectiveness is 125dB @ 1GHz.

	80°C	7916A	NEC:	U-500	U-152.4	18.5	8.4	18 AWG	.180	4.57	Duobond IV*	.298	7.57	75	83%	16.2	53.2	5	.5	1.6	
			CATV CM	500	152.4	19.5	8.9	(solid)			+								55	1.4	4.6
			CEC:	U-1000	U-304.8	35.0	15.9	.040"			60% & 40%								211	2.6	8.5
			CM	1000	304.8	35.0	15.9	BC			Aluminum Braids								500	4.1	13.5
								6.4Ω/M'											750	5.1	16.7
								21.0Ω/km											862	5.5	18.0
																			1000	6.0	19.7
																			1450	7.8	25.6
																			1800	8.4	27.6
																			2250	9.8	32.2

Shielding effectiveness is 125dB @ 1GHz.

Gas-injected Foam Polyethylene Insulation • PVC Jacket (Available in Black, Gray or White)

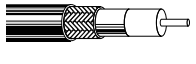
	80°C	1829AC	NEC:	U-1000 [†]	U-304.8	29.0	13.2	18 AWG	.180	4.57	Duobond II + 60%	.270	6.86	75	83%	16.2	53.2	5	.5	1.6	
			CATV CM	1000 ^{††}	304.8	30.0	13.6	(solid)			Aluminum Braid								55	1.4	4.6
			CEC:					.040"											211	2.6	8.5
			CM					BC											500	4.1	13.5
								6.4Ω/M'											750	5.1	16.7
								21.0Ω/km											862	5.5	18.0
																			1000	6.0	19.7
																			1450	7.8	25.6
																			1800	8.6	28.9
																			2250	9.8	32.2
																			3000	11.3	39.0

[†]U-1000 ft. put-up not available in White.
^{††}1000 ft. put-up not available in Gray.

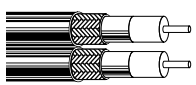
	80°C	1841AC	NEC:	500	152.4	33.5	15.2	18 AWG	.180	4.57	Duobond II + 60%	.273	6.93	75	83%	16.2	53.2	5	.5	1.6	
			CATV CM					(solid)			x x								55	1.4	4.6
			CEC:					.040"											211	2.6	8.5
			CM					BC											500	4.1	13.5
								6.4Ω/M'											750	5.1	16.7
								21.0Ω/km											862	5.5	18.0
																			1000	6.0	19.7
																			1450	7.8	25.6
																			1800	8.4	28.2
																			2250	10.1	32.2
																			3000	11.3	39.0

Plenum • Foam FEP Insulation • Natural Flamarrest® Jacket

		7916AP	NEC:	U-1000	U-304.8	32.0	14.5	18 AWG	.170	4.32	Duobond IV* + 60% & 40%	.248	6.30	75	83%	16.3	53.5	1	.3	1.0	
			CATV CMP	1000	304.8	31.0	14.1	(solid)											10	.7	2.2
			CEC:					.040"											50	1.6	5.3
			CMP FT6					BC											100	2.2	7.2
								6.4Ω/M'											200	3.0	9.8
								21.0Ω/km											400	4.6	15.1
																			700	6.6	21.7
																			900	7.7	25.3
																			1000	8.2	26.9

BC = Bare Copper • DCR = DC Resistance • FEP = Fluorinated Ethylene Propylene

Contact the Belden Customer Service Department for a Comprehensive Connector Cross Reference. **1-800-BELDEN-1**. For additional selection of Belden® Video Cables, refer to the Coaxial and Broadcast Cables sections of this catalog.

* Duobond IV = Duobond II + 60% aluminum braid + Duofoil® tape + 40% aluminum braid.



Video/RF Cable

Broadband CATV Coaxial Cables

Series 6 (RG-6/U Type)

Description	Part No.	UL NEC/ C(UL) CEC Type	Standard Lengths		Standard Unit Weight		Conductor (stranding) Diameter Nom. DCR	Nominal Core OD		Shielding Materials Nom. DCR	Nominal OD		Nom. Imp. (Ω)	Nom. Vel. of Prop.	Nominal Capacitance		Nominal Attenuation		
			Ft.	m	Lbs.	kg		Inch	mm		Inch	mm			pF/Ft.	pF/m	MHz	dB/100 Ft.	dB/100m

Series 6 • 18 AWG Solid .040" Bare Copper-covered Steel Conductor • Duobond® II* + Aluminum Braid Shield (60% Coverage)

Gas-injected Foam Polyethylene Insulation • PVC Jacket (Available in Black, White or White Neutral)

80°C	9116	NEC: CATV CM CEC: CM	U-1000 [▲] 1000	U-304.8 304.8	30.0 31.0	13.6 14.1	18 AWG (solid) .040"	.180	4.57	Duobond II* + 60% Aluminum Braid 28.0Ω/M' 91.9Ω/km	.270	6.86	75	83%	16.2	53.2	See Chart on page 6.92		
------	-------------	-------------------------	-----------------------------	------------------	--------------	--------------	-------------------------	------	------	--	------	------	----	-----	------	------	------------------------	--	--



▲U-1000 ft. put-up also available in Beige.

Gas-injected Foam Polyethylene Insulation • PVC Jacket (Available in Black, White, Gray or Neutral)

80°C	1829A	NEC: CATV CM CEC: CM	U-1000 1000	U-304.8 304.8	29.0 29.0	13.2 13.2	18 AWG (solid) .040"	.180	4.57	Duobond II + 60% Aluminum Braid 28.0Ω/M' 91.9Ω/km	.270	6.86	75	83%	16.2	53.2	5 55 211 500 750 862 1000 1450 1800 2250 3000	.5 1.4 2.6 4.1 5.1 5.5 6.0 7.8 8.6 9.8 11.3	1.6 4.6 8.5 13.5 16.7 18.0 19.7 25.6 28.2 32.2 37.1
------	--------------	-------------------------	----------------	------------------	--------------	--------------	-------------------------	------	------	---	------	------	----	-----	------	------	---	---	---



80°C	1829R <small>new</small>	NEC: CATVR, CMR CEC: CMG FT4	U-1000* 1000	U-304.8 304.8	29.0 29.0	13.2 13.2	18 AWG (solid) .040"	.180	4.57	Duobond II + 60% Aluminum Braid 28.0Ω/M' 91.9Ω/km	.270	6.86	75	83%	16.2	53.2	5 55 211 500 750 862 1000 1450 1800 2250 3000	.5 1.4 2.6 4.1 5.1 5.5 6.0 7.8 8.6 9.8 11.3	1.6 4.6 8.5 13.5 16.7 18.0 19.7 25.6 28.2 32.2 37.1
------	------------------------------------	---------------------------------	-----------------	------------------	--------------	--------------	-------------------------	------	------	---	------	------	----	-----	------	------	---	---	---



*U-1000 ft. put-up not available in Neutral.

Plenum • Foam FEP Insulation • Natural Flamarrest® Jacket

75°C	1829P <small>new</small>	NEC: CATVP, CMP CEC: CMP FT6	U-1000 1000	U-304.8 304.8	27.0 27.0	12.3 12.3	18 AWG (solid) .040"	.170	4.32	Duobond II + 60% Aluminum Braid 28.0Ω/M' 91.9Ω/km	.235	5.97	75	83%	16.3	53.5	1 10 50 100 200 400 700 900 1000 1450 1800 2250 3000	.3 .7 1.5 2.1 3.0 4.4 6.1 7.2 7.6 9.6 11.0 12.7 15.1	1.0 2.2 4.9 6.9 9.8 14.4 20.0 23.6 24.9 31.5 36.1 41.7 49.5
------	------------------------------------	---------------------------------	----------------	------------------	--------------	--------------	-------------------------	------	------	---	------	------	----	-----	------	------	--	--	---



Sweep tested 950 MHz to 2.25 GHz.

Sweep tested 5 MHz to 3.0 GHz.

Series 6 • 18 AWG Solid .040" Bare Copper-covered Steel Conductor • Duobond® IV* Quad Shield (60% and 40% Coverage)

Gas-injected Foam Polyethylene Insulation • PVC Jacket (Available in Black or White)

80°C	1189A	NEC: CATV CM CEC: CM	U-500 1000 [▼]	U-152.4 304.8	18.0 35.0	8.2 15.9	18 AWG (solid) .040"	.180	4.57	Duobond IV 60% & 40% Aluminum Braids 28.0Ω/M' 91.9Ω/km	.298	7.57	75	83%	16.2	53.2	See Chart on page 6.88		
------	--------------	-------------------------	----------------------------	------------------	--------------	-------------	-------------------------	------	------	--	------	------	----	-----	------	------	------------------------	--	--



▼1000 ft. put-up also available in Beige or Neutral.

Sweep tested 5 MHz to 1 GHz.

Plenum • Foam FEP Insulation • Natural Flamarrest Jacket

75°C	1189AP	NEC: CATVP, CMP CEC: CMP FT6	1000 [†]	304.8	32.0	14.5	18 AWG (solid) .040"	.170	4.32	Duobond IV 60% & 40% Aluminum Braids 28.0Ω/M' 91.9Ω/km	.248	6.30	75	83%	16.3	53.5	1 10 50 100 200 400 700 900 1000	.3 .7 1.6 2.2 3.0 4.6 6.6 7.7 8.2	1.0 2.2 5.2 7.2 9.8 15.1 21.7 25.3 26.9
------	---------------	---------------------------------	-------------------	-------	------	------	-------------------------	------	------	--	------	------	----	-----	------	------	--	---	---



Sweep tested 5 MHz to 1 GHz.

BCCS = Bare Copper-covered Steel • DCR = DC Resistance

Contact the Belden Customer Service Department for a Comprehensive Connector Cross Reference. **1-800-BELDEN-1**.

* Duobond II = Bonded Duofoil® (100% coverage) + aluminum braid (60% coverage).

For additional selection of Belden® Video Cables, refer to the Coaxial and Broadcast Cables sections of this catalog.

Duobond IV = Duobond II + 60% aluminum braid + Duofoil® tape + 40% aluminum braid.

†Spools and/or UnReel® cartons are one piece, but length may vary ±10% for spools and ±5% for UnReel from length shown.

Video Cable

Precision Video Cables for Analog and Digital Applications

RG-6/U and RG-59/U Types

Description	Part No.	UL NEC/ C(UL) CEC Type	Standard Lengths		Standard Unit Weight		Conductor (stranding) Diameter Nom. DCR	Nominal Core OD		Shielding Materials Nom. DCR	Nominal OD		Nom. Imp. (Ω)	Nom. Vel. of Prop.	Nominal Capacitance		Nominal Attenuation		
			Ft.	m	Lbs.	kg		Inch	mm		Inch	mm			pF/Ft.	pF/m	MHz	dB/ 100 Ft.	dB/ 100m

RG-6/U Type • 18 AWG Solid .040" Bare Copper Conductor • Duofoil® (100% Coverage) + Tinned Copper Braid Shield (95% Coverage)

Gas-injected Foam HDPE Insulation • PVC Jacket (Available in 10 colors)*

SDI/HDTV	1694A	NEC:	500 [▲]	152.4	20.5	9.3	18 AWG	.180	4.57	Duofoil + 95%	.274	6.96	75	82%	16.2	53.2	1	.2	.8
Digital Video		CMR	1000	304.8	45.0	20.5	(solid)			+ 95%							3.6	.5	1.5
75°C		CEC:	4500	1371.6	202.5	91.9	.040"			TC Braid							10	.7	2.4
		CMG FT4					BC			2.8Ω/M'							71.5	1.6	5.2
							6.4Ω/M'			9.2Ω/km							135	2.1	6.9
							21.0Ω/km										270	3.0	9.7
											For Plenum version of 1694A, see 1695A.						360	3.4	11.3
											Also available in bundled versions. See 7710A through 7713A.						540	4.3	13.9
											100% Sweep tested. 5 MHz to 3 GHz.						720	4.9	16.1
																	750	5.0	16.4
																	1000	5.9	19.3
																	1500	7.3	24.0
																	2250	9.1	30.0
																	3000	10.7	35.0
																	4500	13.3	43.6

[▲]500 ft. put-up available in Black only.

*Available in Black, Brown, Red, Orange, Yellow, Green, Blue, Purple, Gray or White. Black jacket suitable for Outdoor and Aerial applications.

Plenum • Foam FEP Teflon® Insulation • Flamarest® Jacket (Available in 10 colors)**

SDI/HDTV	1695A	NEC:	500 [†] *	152.4	20.5	9.3	18 AWG	.170	4.32	Duofoil + 95%	.234	5.94	75	82%	16.2	53.2	1	.2	.8
Digital Video		CMR	1000 [†]	304.8	45.0	20.5	(solid)			+ 95%							3.6	.5	1.5
75°C		CEC:					.040"			TC Braid							10	.8	2.5
		CMG FT6					BC			2.8Ω/M'							71.5	1.8	5.8
							6.4Ω/M'			9.2Ω/km							135	2.4	7.9
							21.0Ω/km										270	3.4	11.2
											100% Sweep tested. 5 MHz to 3 GHz.						360	4.0	13.1
																	540	5.2	17.1
																	720	6.1	20.0
																	750	6.2	20.3
																	1000	7.3	24.0
																	1500	9.2	30.2
																	2250	11.6	38.0
																	3000	13.7	44.9

[†]500 ft. put-up available in Black or Natural only.

**Available in Black, Brown, Red, Orange, Yellow, Green, Blue, Purple, Gray or Natural. Black jacket suitable for Outdoor and Aerial applications.

Gas-injected Foam HDPE Insulation • Overall Matte Black PVC Jacket (Color Code: See chart below)

SDI/HDTV	7713A	NEC:	500	152.4	463.0	210.0	18 AWG	.180	4.57	Duofoil + 95%	1.386	35.20	75	82%	16.2	53.2	1	.2	.8
Digital Video		CMR	1000	304.8	904.0	410.4	(solid)			+ 95%							3.6	.5	1.5
75°C		CEC:					.040"			TC Braid							10	.7	2.4
		CMG FT4					BC			3.0Ω/M'							71.5	1.6	5.2
							6.4Ω/M'			9.8Ω/km							135	2.1	6.9
							21.0Ω/km										270	3.0	9.7
											7713A has ten conductors. For other bundled versions of 1694A see 7710A through 7712A.						360	3.4	11.3
											100% Sweep tested. 5 MHz to 3 GHz.						540	4.3	13.9
																	720	4.9	16.1
																	750	5.0	16.4
																	1000	5.9	19.3
																	1500	7.3	24.0
																	2500	9.1	31.8
																	3000	10.7	35.0

RG-59/U Type • 20 AWG Solid .032" Bare Copper Conductor • Duofoil (100% Coverage) + Tinned Copper Braid Shield (95% Coverage)

Gas-injected Foam HDPE Insulation • PVC Jacket (Available in 10 colors)*

SDI/HDTV	1505A	NEC:	500 [▼]	152.4	15.5	7.0	20 AWG	.145	3.68	Duofoil + 95%	.233	5.92	75	83%	16.3	53.5	1	.3	1.0
Digital Video		CMR	1000 [*]	304.8	35.0	15.9	(solid)			+ 95%							3.6	.6	1.8
75°C		CEC:	5000 [*]	1524.0	165.0	74.9	.032"			TC Braid							10	.9	2.9
		CMG FT4					BC			3.8Ω/M'							71.5	2.1	6.9
							10.0Ω/M'			12.5Ω/km							135	2.7	8.9
							32.8Ω/km										270	3.8	12.5
											For Plenum version of 1505A, see 1506A.						360	4.4	14.4
											Also available in bundled versions. See 7794A through 7798A.						540	5.5	18.0
											100% Sweep tested. 5 MHz to 3 GHz.						720	6.4	21.0
																	750	6.5	21.3
																	1000	7.6	24.9
																	1500	9.3	30.5
																	2250	11.6	38.0
																	3000	13.4	44.0
																	4500	16.4	53.8

[▼]500 ft. put-up available in Black, Red or Blue only.

^{*}1000 ft. and 5000 ft. put-ups available in all ten colors: Black, Brown, Red, Orange, Yellow, Green, Blue, Purple, Gray or White.

BC = Bare Copper • DCR = DC Resistance • HDPE = High-density Polyethylene • TC = Tinned Copper

Contact the Belden Customer Service Department for a Comprehensive Connector Cross Reference. **1-800-BELDEN-1.** Request quotations of RG/U cables not listed. For additional selection of Belden® Video Cables, refer to the Coaxial and Broadcast Cables sections of this catalog.

[†]Spools are one piece, but length may vary ±10% from length shown.

Teflon is a DuPont trademark.

Color Code Chart

Cond.	Color	Cond.	Color
1	Red	6	Brown
2	Green	7	Orange
3	Blue	8	Gray
4	White	9	Purple
5	Yellow	10	Black



Video Cable

Precision Video Cables for Analog and Digital Applications
Subminiature and Standard Analog RG-59/U Types

Description	Part No.	UL NEC/ C(UL) CEC Type	Standard Lengths		Standard Unit Weight		Conductor (stranding) Diameter Nom. DCR	Nominal Core OD		Shielding Materials Nom. DCR	Nominal OD		Nom. Imp. (Ω)	Nom. Vel. of Prop.	Nominal Capacitance		Nominal Attenuation				
			Ft.	m	Lbs.	kg		Inch	mm		Inch	mm			pF/Ft.	pF/m	MHz	dB/100 Ft.	dB/100m		
Subminiature RG-59/U Type • 23 AWG Solid .023" Bare Copper Conductor • Duofoil® (100% Coverage) + TC Braid Shield (95% Coverage)																					
Gas-injected Foam HDPE Insulation • PVC Jacket (Available in 10 colors)*																					
SDI/HDTV	1855A	NEC:	500 [▲]	152.4	9.0	4.1	23 AWG	.102	2.59	Duofoil	.159	4.03	75	82%	16.3	53.5	1	.4	1.3		
Digital Video		CMR	1000	304.8	16.0	7.3	(solid)			+ 95%								3.6	.8	2.6	
75°C		CEC:					.023"			TC Braid									10	1.2	3.9
		CMG FT4					BC			7.6Ω/M'									71.5	3.1	10.0
							20.1Ω/M'			24.9Ω/km									135	3.8	12.5
							65.9Ω/km												270	5.4	17.7
																			360	6.2	20.3
																			540	7.7	25.3
																			720	9.5	31.1
																			750	9.6	31.5
																		1000	10.5	34.4	
																		1500	13.0	42.6	
																		2250	16.0	52.5	
																		3000	18.5	60.7	
																		4500	22.8	74.8	

*500 ft. put-up available in Black only.

Standard Analog • RG-59/U Type • 23 AWG Solid .023" Bare Copper Conductor • Bare Copper Braid Shield (95% Coverage)

Polyethylene Insulation • Black PVC Jacket																					
Description	Part No.	UL AWM	Standard Lengths		Standard Unit Weight		Conductor (stranding) Diameter Nom. DCR	Nominal Core OD		Shielding Materials Coverage	Nominal OD		Nom. Imp. (Ω)	Nom. Vel. of Prop.	Nominal Capacitance		Nominal Attenuation				
			U-1000	U-304.8	36.0	16.3		Inch	mm		Inch	mm			pF/Ft.	pF/m	MHz	dB/100 Ft.	dB/100m		
Style 1354 (30V 80°C)	8241B	NEC:	U-1000	U-304.8	36.0	16.3	23 AWG	.146	3.71	BC Braid	.242	6.15	75	66%	20.5	67.3	1	.4	1.3		
		CM	1000	304.8	37.0	16.8	(solid)			95% Shield								10	1.1	3.6	
		CEC:					.023"			Coverage									50	2.4	7.9
		CM					BC			2.9Ω/M'									100	3.4	11.2
							20.4Ω/M'			9.5Ω/km									200	4.9	16.1
							66.9Ω/km												400	7.0	23.0
																			700	9.7	31.8
																			900	11.1	36.4
																			1000	12.0	39.4

Suitable for Outdoor applications.

BC = Bare Copper • DCR = DC Resistance • HDPE = High-density Polyethylene • TC = Tinned Copper

Contact the Belden Customer Service Department for a Comprehensive Connector Cross Reference. **1-800-BELDEN-1**. Request quotations of RG/U cables not listed. For additional selection of Belden® Video Cables, refer to the Coaxial and Broadcast Cables sections of this catalog.

*Available in Brown, Red, Orange, Yellow, Green, Blue, Purple, Gray, White or Black.

Video Cable

Bundled RGB Precision Video Cable and Miniature Hi-Res Component Video Cables

Description	Part No.	UL NEC/ C(UL) CEC Type	No. of Cond.	Standard Lengths		Standard Unit Weight		Conductor (stranding) Diameter	Nominal Core OD		Shielding Materials	Nominal OD		Nom. Imp. (Ω)	Nom. Vel. of Prop.	Nominal Capacitance		Nominal Attenuation	
				Ft.	m	Lbs.	kg		Inch	mm		Inch	mm			pF/Ft.	pF/m	MHz	dB/100 Ft.

25 AWG Solid .018" Tinned Copper Conductors • Duobond® + Tinned Copper Interlocked Serve Shield (95% Coverage)

FPFA Insulation • Inner PVC Jacket (Color Code: Red, Green, Blue, White, Yellow) • Overall Black PVC Jacket

	300V RMS 60°C	1277R <small>new</small>	NEC: CMR CEC: CMG	3	500 [†] 1000 [†]	152.4 304.8	25.5 48.0	11.6 21.8	25 AWG (solid) .018"	.074 .114	1.88 2.90	Duobond + 95% TC Braid	.320 .351	8.13 8.92	75	80%	17.0 55.8	1 5 50 100 200 400 750 900 1000 3000	.5 1.2 3.7 4.9 6.7 9.5 13.4 15.0 15.8 31.2	1.7 3.8 12.1 16.1 22.0 31.2 44.0 49.2 51.8 102.4
									34.0Ω/M' 111.6Ω/km			5.4Ω/M' 17.7Ω/km								
		1278R <small>new</small>	NEC: CMR CEC: CMG	4	500 [†] 1000 [†]	152.4 304.8	31.5 60.0	14.3 27.2	same as above	.074 Coax OD: .114	1.88 2.90	same as above	.351	8.92						
		1279R <small>new</small>	NEC: CMR CEC: CMG	5	250 [†] 500 [†] 1000 [†]	76.2 152.4 304.8	21.8 40.5 80.0	9.9 18.4 36.3	same as above	.074 Coax OD: .114	1.88 2.90	same as above	.403	10.24						
		1280R <small>new</small>	NEC: CMR CEC: CMG	6	500 [†] 1000 [†]	152.4 304.8	44.0 87.0	20.0 39.5	same as above	.074 Coax OD: .114	1.88 2.90	same as above	.423	10.74						

100% Sweep tested. 5 MHz to 850 MHz.

Miniature • 25 AWG Solid .018" Tinned Copper Conductors • Duobond® (100% Coverage) + TC Braid Shield (95% Coverage)

Plenum • FPFA Insulation • Black Flamarrest® Jacket

	1282P <small>new</small>	NEC: CMP CEC: CMP FT6	1	1000	304.8	10.0	4.5	25 AWG (solid) .018" TC	.074	1.88	Duobond (100%) + TC Braid	.114	2.90	75	81%	17.0 55.2	1 5 50 100 200 400 700 900 1000 3000	.4 .9 3.7 5.0 7.0 10.0 14.5 17.0 17.5 37.0	1.3 3.0 12.1 16.4 23.0 32.8 47.6 55.8 57.4 121.4
								31.8Ω/M' 104.3Ω/km			5.8Ω/M' 19.0Ω/km								

Sweep Tested 5 MHz to 850 MHz.
Guaranteed Return Loss -20dB Max.

BC = Bare Copper • DCR = DC Resistance • FPFA = Foam Perfluoroalkoxy • HDPE = High-density Polyethylene • TC = Tinned Copper

Contact the Belden Customer Service Department for a more Comprehensive Connector Cross Reference. **1-800-BELDEN-1**. Request quotations of cables not listed.

[†]Spools are one piece, but length may vary ±10% from length shown.

Video Cable

RGB Component Video Cable

Banana Peel® Unjacketed Bundles Mini Hi-Res Component Video

Description	Part No.	UL NEC/ C(UL) CEC Type	No. of Cond.	Standard Lengths		Standard Unit Weight		Conductor (stranding) Diameter Nom. DCR	Nominal Core OD		Shielding Materials Nom. DCR	Nominal OD		Nom. Imp. (Ω)	Nom. Vel. of Prop.	Nominal Capacitance		Nominal Attenuation		
				Ft.	m	Lbs.	kg		Inch	mm		Inch	mm			pF/Ft.	pF/m	MHz	dB/ 100 Ft.	dB/ 100m

Miniature • 25 AWG Solid .018" TC Conductors • Duobond® (100% Coverage) + TC Interlocked Serve Shield (95% Coverage)

Gas-injected Foam HDPE Insulation • PVC Jackets (Color Code: See chart below) • Center Spine • No Overall Jacket

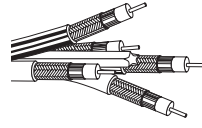
	1281S3 <small>new</small>	NEC: CMR CEC: CMG	3	500 [†] 1000 [†]	152.4 304.8	17.0 31.0	7.7 14.1	25 AWG (solid) .018" TC 34.0Ω/M' 111.6Ω/km	.074	1.88	Duobond (100%) + TC Serve (95%) 5.4Ω/M' 17.7Ω/km	Single: .114 2.90 Overall: .246 6.25	75	80%	17.0	.8	1 5 50 100 200 400 750 900 1000 3000	.5 1.2 3.7 4.9 6.7 9.5 13.4 15.0 15.8 31.2	1.6 3.8 12.1 16.1 22.0 31.2 44.0 49.2 51.8 102.4	
	1281S4 <small>new</small>	NEC: CMR CEC: CMG	4	500 [†] 1000 [†]	152.4 304.8	23.5 44.0	10.7 20.0	same as above	.074	1.88	same as above	Single: .114 2.90 Overall: .275 6.99								
	1281S5 <small>new</small>	NEC: CMR CEC: CMG	5*	250 [†] 500 [†] 1000 [†]	76.2 152.4 304.8	16.0 28.5 55.0	7.3 12.9 25.0	same as above	.074	1.88	same as above	Single: .114 2.90 Overall: .308 7.82								
	1281S6 <small>new</small>	NEC: CMR CEC: CMG FT4	6*	500 [†] 1000 [†]	152.4 304.8	33.5 68.0	15.2 30.8	same as above	.074	1.88	same as above	Single: .114 2.90 Overall: .342 8.69								
	<p>100% Sweep tested. 5 MHz to 850 MHz. Guaranteed Return Loss -20db max. U.S. Patent 7,049,523.</p>																			

Plenum • FPFA • Flamarrest® Jackets (Color Code: See chart below) • Center Spine • No Overall Jacket

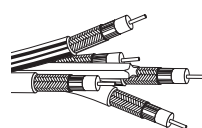
	1282S3 <small>new</small>	NEC: CMP CEC: CMP	3	500 1000	152.4 304.8	18.5 34.0	8.4 15.4	25 AWG (solid) .018" TC 34.0Ω/M' 111.6Ω/km	.075	1.91	Duobond (100%) + TC Serve (95%) 5.4Ω/M' 17.7Ω/km	Single: .114 2.90 Overall: .246 6.25	75	81%	16.8	55.2	1 5 50 100 200 400 750 1000 2250 3000	.5 1.2 3.8 5.2 7.1 10.0 14.3 16.9 25.5 33.9	1.6 3.9 12.1 17.1 23.1 32.9 47.0 55.4 83.6 111.3	
	1282S4 <small>new</small>	NEC: CMP CEC: CMP	4	500 1000	152.4 304.8	25.5 49.0	11.6 22.2	same as above	.075	1.91	same as above	Single: .114 2.90 Overall: .275 6.99								
	1282S5 <small>new</small>	NEC: CMP CEC: CMP	5*	250 500 1000	76.2 152.4 304.8	18.0 33.0 67.0	8.2 15.0 30.4	same as above	.075	1.91	same as above	Single: .114 2.90 Overall: .308 7.82								
	1282S6 <small>new</small>	NEC: CMP CEC: CMP	6*	500 1000	152.4 304.8	39.5 80.0	17.9 36.3	same as above	.075	1.91	same as above	Single: .114 2.90 Overall: .342 8.69								
	<p>100% Sweep tested. 5 MHz to 850 MHz. Guaranteed Return Loss -20db max. U.S. Patent 7,049,523.</p>																			

DCR = DC Resistance • FPFA = Foam Perfluoroalkoxy • HDPE = High-density Polyethylene • TC = Tinned Copper

Contact the Belden Customer Service Department for a more Comprehensive Connector Cross Reference. **1-800-BELDEN-1**. Request quotations of cables not listed.

[†]Spools are one piece, but length may vary ±10% from length shown.

*Also available with all Black jackets.

Color Code Chart:

Cond.	Color	Cond.	Color
1	Red	4	Yellow
2	Green	5	Black
3	Blue	6	White

Video Cable

RGB Coaxial Cable

Banana Peel® Unjacketed VideoFLEX® Bundles, RG-59/U Type

Description	Part No.	UL NEC/ C(UL) CEC Type	No. of Cond.	Standard Lengths		Standard Unit Weight		Conductor (stranding) Diameter Nom. DCR	Nominal Core OD		Shielding Materials Nom. DCR	Nominal OD		Nom. Imp. (Ω)	Nom. Vel. of Prop.	Nominal Capacitance		Nominal Attenuation	
				Ft.	m	Lbs.	kg		Inch	mm		Inch	mm			pF/Ft.	pF/m	MHz	dB/ 100 Ft.

RG-59/U • 20 AWG Solid .032" Bare Copper Conductors • Duofoil® (100% Coverage) + Tinned Copper Braid Shield (95% Coverage)

Plenum • Foam FEP Insulation • Plenum-Grade PVC Jackets (Color Code: See chart below) • **Center Spine • No Overall Jacket**

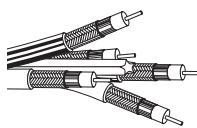
	300V RMS	1283S3 <small>new</small>	NEC: 3 CMP CEC: 500 CMP	250 500 1000	76.2 152.4 304.8	26.3 54.0 103.0	11.9 24.5 46.7	20 AWG (solid) .032" BC 10.0Ω/M' 32.8Ω/km	.133	3.38	Duofoil (95%) + TC Braid 3.8Ω/M' 12.5Ω/km	.422	10.72	75	83%	16.2	53.2	1	.3	1.0	
																		3.6	.6	2.0	
																			10	.9	2.9
																			71.5	2.1	6.9
																			135	2.7	8.9
																			270	3.8	12.5
																			360	4.4	14.4
																			540	5.5	18.0
																			720	6.4	21.0
																			750	6.5	21.3
																		1000	7.6	24.9	
																		1500	9.4	30.8	
																		2500	12.4	40.7	
																		3000	13.8	45.3	

Sweep tested. 5 MHz to 3 GHz.
U.S. Patent 7,049,523.

Suitable for Indoor and Outdoor applications.

BC = Bare Copper • DCR = DC Resistance • FEP = Fluorinated Ethylene Propylene • TC = Tinned Copper

Contact the Belden Customer Service Department for a more Comprehensive Connector Cross Reference. **1-800-BELDEN-1**. Request quotations of cables not listed.

Color Code Chart:

Cond.	Color	Cond.	Color
1	Red	4	Yellow
2	Green	5	Black
3	Blue	6	White



Video Cable

High-Flex S-Video Cables

Description	Part No.	UL NEC/ C(UL) CEC Type	No. of Cond.	Standard Lengths		Standard Unit Weight		Conductor (stranding) Diameter	Nominal Core OD		Shielding Materials	Nominal OD		Nom. Imp. (Ω)	Nom. Vel. of Prop.	Nominal Capacitance		Nominal Attenuation		
				Ft.	m	Lbs.	kg		Inch	mm		Inch	mm			pF/Ft.	pF/m	MHz	dB/ 100 Ft.	dB/ 100m

High-Flex S-Video • 30 AWG Stranded (7x38) Tinned Copper Conductors • Tinned Copper Serve Shield (90% Coverage)

Foam HDPE Insulation • Matte Black PVC Jacket (One Coax Printed and Striped for Identification)																								
Parallel Zip Construction	1807A		2	U-500	U-152.4	8.0	3.6	30 AWG (7x38)	.056	1.42	TC Serve	.110	2.79	75	78%	17.3	56.7	1	.6	2.0				
				500	152.4	7.5	3.4	(7x38)			90% Shield	x	x							5	1.4	4.6		
				U-1000	U-304.8	15.0	6.8	.012"			Coverage	.230	5.84								10	2.1	6.9	
				1000	304.8	14.0	6.4	TC			7.5Ω/M'											30	3.8	12.5
												100.0Ω/M'											50	5.1
								328.0Ω/km												100	7.6	24.9		
																				200	11.3	37.1		
																				400	16.9	55.4		
																				700	23.3	76.4		
																				900	26.9	88.2		
																				1000	28.6	93.8		

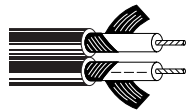

For Plenum version of 1807A, see 7700A.

Foam HDPE Insulation • Matte Black PVC Jacket (Inner PVC Jackets Color Code: Black and Yellow)																									
Round Construction	1808A <small>new</small>		2	U-500	U-152.4	14.5	6.6	30 AWG (7x38)	.058	1.47	TC Serve	.255	.84	75	78%	17.3	56.7	1	.6	2.0					
				500	152.4	16.5	7.5	(7x38)			90% Shield										5	1.4	4.6		
				U-1000	U-304.8	31.0	14.1	.013"			Coverage	.100	2.54									10	2.1	6.9	
				1000	304.8	33.0	15.0	TC			7.5Ω/M'												30	3.8	12.5
												100.0Ω/M'												50	5.1
								328.0Ω/km													100	7.6	24.9		
																					200	11.3	37.1		
																					400	16.9	55.4		
																					700	23.3	76.4		
																					900	26.9	88.2		
																					1000	28.6	93.8		

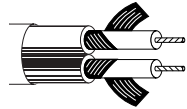

Available in Plenum versions by special order only.

High-Flex S-Video • 30 AWG Stranded (7x38) .012" Tinned Copper Conductors • Tinned Copper "French Braid" Shield (98% Coverage)

Plenum • Foam FEP Teflon® Insulation • Matte Black Flamarrest® Jacket (One Coax Printed and Striped for Identification)																										
Parallel Zip Construction	7700A <small>new</small>	NEC: CMP CEC: CMP FT6	2	500	152.4	8.5	3.9	30 AWG (7x38)	.053	1.35	TC	.107	2.72	75	78%	17.3	56.7	1	.5	2.3						
				1000	304.8	17.0	7.7	(7x38)			"French Braid"	x	x								5	1.7	5.6			
								.012"			Coverage	.214	5.44										10	2.3	7.5	
								TC			98% Shield													30	4.1	13.4
												100.0Ω/M'													50	5.3
								328.0Ω/km														100	7.6	24.9		
																						200	11.8	38.7		
																						400	17.6	57.7		
																						700	24.2	79.4		
																						900	28.0	91.8		
																						1000	29.8	97.7		

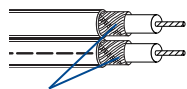

French Braid

BC = Bare Copper • DCR = DC Resistance • FEP = Fluorinated Ethylene Propylene • HDPE = High-density Polyethylene • TC = Tinned Copper

Contact the Belden Customer Service Department for a Comprehensive Connector Cross Reference. **1-800-BELDEN-1**. For additional selection of Belden® Video Cables, refer to the Coaxial and Broadcast Cables sections of this catalog.

Teflon is a DuPont trademark.



For more information, contact Belden Technical Support: **1-800-BELDEN-1** • www.belden.com

Speaker Cable

Low-Capacitance OFHC Speaker Cable

Description	Part No.	UL NEC/ C(UL) CEC Type	No. of Cond.	Standard Lengths		Standard Unit Weight		Insulation Thickness		Jacket Thickness		Nominal OD		Nominal Capacitance*	
				Ft.	m	Lbs.	kg	Inch	mm	Inch	mm	Inch	mm	pF/Ft.	pF/m

Low Cap • 16 AWG Stranded (65x34) Oxygen-free High-Conductivity Bare Copper Conductors • Conductors Cabled • Unshielded

Polyolefin Insulation • PVC Jacket (Available in Black, White, Gray, Blue or Green)

	1307A <small>new</small>	NEC: CMR, CL3R CEC: CMG FT4	2	U-500 1000 †	U-152.4 304.8	15.0 29.0	6.8 13.2	.013	.32	.022	.56	.210	5.33	19.9	65.3
--	------------------------------------	--------------------------------------	---	-----------------	------------------	--------------	-------------	------	-----	------	-----	------	------	------	------

Suitable for Direct Burial applications. White and Black jackets are Sunlight-resistant.

	1308A <small>new</small>	NEC: CMR, CL3R CEC: CMG FT4	4	U-500 1000 †	U-152.4 304.8	26.5 54.0	12.0 24.5	.013	.32	.026	.66	.270	6.86	19.9	65.3
--	------------------------------------	--------------------------------------	---	-----------------	------------------	--------------	--------------	------	-----	------	-----	------	------	------	------

Suitable for Direct Burial applications. White and Black jackets are Sunlight-resistant.

Low Cap • 14 AWG Stranded (105x34) Oxygen-free High-Conductivity Bare Copper Conductors • Conductors Cabled • Unshielded

Polyolefin Insulation • PVC Jacket (Available in Black, White, Gray, Blue or Green)

	1309A <small>new</small>	NEC: CMR, CL3R CEC: CMG FT4	2	U-500 1000 †	U-152.4 304.8	22.5 46.0	10.2 20.9	.016	.39	.027	.69	.264	6.71	20.5	67.3
--	------------------------------------	--------------------------------------	---	-----------------	------------------	--------------	--------------	------	-----	------	-----	------	------	------	------

Suitable for Direct Burial applications. White and Black jackets are Sunlight-resistant.

	1310A <small>new</small>	NEC: CMR, CL3R CEC: CMG FT4	4	U-500 1000 †	U-152.4 304.8	41.5 84.0	18.8 38.1	.016	.39	.033	.94	.319	8.10	20.5	67.3
--	------------------------------------	--------------------------------------	---	-----------------	------------------	--------------	--------------	------	-----	------	-----	------	------	------	------

Suitable for Direct Burial applications. White and Black jackets are Sunlight-resistant.

Low Cap • 12 AWG Stranded (168x34) Oxygen-free High-Conductivity Bare Copper Conductors • Conductors Cabled • Unshielded

Polyolefin Insulation • PVC Jacket (Available in Black, White or Gray)

	1311A <small>new</small>	NEC: CMR, CL3R CEC: CMG FT4	2	U-500 500 1000 †	U-152.4 152.4 304.8	36.5 36.5 74.0	16.6 16.6 33.6	.018	.46	.036	.91	.352	8.94	22.3	73.2
--	------------------------------------	--------------------------------------	---	------------------------	---------------------------	----------------------	----------------------	------	-----	------	-----	------	------	------	------

Suitable for Direct Burial applications. White and Black jackets are Sunlight-resistant.

	1312A <small>new</small>	NEC: CMR, CL3R CEC: CMG FT4	4	500 1000 †	152.4 304.8	66.5 132.0	30.2 59.9	.018	.46	.043	1.09	.423	10.74	22.3	73.2
--	------------------------------------	--------------------------------------	---	---------------	----------------	---------------	--------------	------	-----	------	------	------	-------	------	------

Suitable for Direct Burial applications. White and Black jackets are Sunlight-resistant.

Low Cap • 10 AWG Stranded (259x34) Oxygen-free High-Conductivity Bare Copper Conductors • Conductors Cabled

Polyolefin Insulation • PVC Jacket (Available in Black, White or Gray)

	1313A <small>new</small>	NEC: CMR, CL3R CEC: CMG FT4	2	500 1000 †	152.4 304.8	55.0 109.0	25.0 49.5	.019	.48	.044	1.12	.428	10.87	23.2	76.1
--	------------------------------------	--------------------------------------	---	---------------	----------------	---------------	--------------	------	-----	------	------	------	-------	------	------

Suitable for Direct Burial applications. White and Black jackets are Sunlight-resistant.

OFHC = Oxygen-Free High-Conductivity

*Capacitance between conductors.

†1000 ft. put-ups not available in Blue or Green.

Color Code Chart

Cond.	Color
1	Black
2	Red
3	White
4	Green

Speaker Cable

Multi-conductor Cables for Residential, Light Commercial and Institutional Applications

Description	Part No.	UL NEC/ C(UL) CEC Type	No. of Cond.	Color Code	Standard Lengths		Standard Unit Weight		Insulation Thickness		Outer Jacket Thickness		Nominal OD	
					Ft.	m	Lbs.	kg	Inch	mm	Inch	mm	Inch	mm

Multi-conductor • 16 AWG Stranded (19x29) Bare Copper Conductors • Rip Cord

Non-Plenum • PVC Insulation • Gray PVC Jacket

 <p>Rip Cord</p>	300V 75°C	5200UE	NEC: CMR CEC: CMG FT4	2	Black, Red	C-500 U-500 500 U-1000 1000	C-152.4 U-152.4 152.4 U-304.8 304.8	11.5 5.2 13.0 12.5 25.0 11.4	5.2 5.9 5.7 11.4 11.4	.010	.25	.015	.38	.184	4.67
---	-----------	---------------	--------------------------------	---	---------------	---	---	---	-----------------------------------	------	-----	------	-----	------	------

Jacket sequentially marked at 2 ft. intervals.

 <p>Rip Cord</p>	300V 75°C	5202UE	NEC: CMR CEC: CMG FT4	4	Black, Red, White, Green	U-500 500 U-1000 1000	U-152.4 152.4 U-304.8 304.8	23.5 10.7 23.0 10.4 45.0 20.4 47.0 21.3	10.7 10.4 20.4 21.3	.010	.25	.015	.38	.216	5.49
---	-----------	---------------	--------------------------------	---	-----------------------------------	--------------------------------	--------------------------------------	--	------------------------------	------	-----	------	-----	------	------

Jacket sequentially marked at 2 ft. intervals.

Plenum • Flamarrest® Insulation • Natural Flamarrest Jacket

 <p>Rip Cord</p>	300V 75°C	6200UE	NEC: CMP CEC: CMP FT6	2	Black, Red	500 U-1000 1000	152.4 U-304.8 304.8	13.0 5.9 25.0 11.4 26.0 11.8	5.9 11.4 11.8	.009	.23	.015	.38	.180	4.57
---	-----------	---------------	--------------------------------	---	---------------	-----------------------	---------------------------	---	---------------------	------	-----	------	-----	------	------

Jacket sequentially marked at 2 ft. intervals.

Multi-conductor • 14 AWG Stranded (19x27) Bare Copper Conductors • Rip Cord

Non-Plenum • PVC Insulation • PVC Jacket (Available in Red* or Gray)

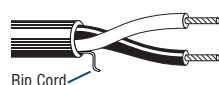
 <p>Rip Cord</p>	300V 75°C	5100UE	NEC: CL3R FPLR*	2	Black, White	500 [†] U-1000 [†] 1000	152.4 U-304.8 304.8	20.0 9.1 38.0 17.2 40.0 18.2	9.1 17.2 18.2	.014	.36	.015	.38	.234	5.94
---	-----------	---------------	-----------------------	---	-----------------	---	---------------------------	---	---------------------	------	-----	------	-----	------	------

[†]500 ft. and U-1000 ft. put-ups available in Gray only.

*Red jacket only suitable for Fire Alarm applications.

Jacket sequentially marked at 2 ft. intervals.

Plenum • Flamarrest Insulation • Natural Flamarrest Jacket

 <p>Rip Cord</p>	150V 75°C	6100UE	NEC: CL2P	2	Black, White	500 U-1000 1000 5000	152.4 U-304.8 304.8 1524.0	19.5 8.9 38.0 17.2 38.0 17.2 195.0 88.5	8.9 17.2 17.2 88.5	.011	.28	.015	.38	.222	5.64
---	-----------	---------------	--------------	---	-----------------	-------------------------------	-------------------------------------	--	-----------------------------	------	-----	------	-----	------	------

Jacket sequentially marked at 2 ft. intervals.

Multi-conductor • 12 AWG Stranded (19x25) Bare Copper Conductors • Rip Cord

Non-Plenum • PVC Insulation • PVC Jacket (Available in Red* or Gray)

 <p>Rip Cord</p>	300V 75°C	5000UE	NEC: CL3R FPLR*	2	Black, White	500 [†] 1000	152.4 304.8	29.0 13.2 57.0 25.9	13.2 25.9	.014	.36	.015	.38	.268	6.81
---	-----------	---------------	-----------------------	---	-----------------	--------------------------	----------------	------------------------------	--------------	------	-----	------	-----	------	------

[†]500 ft. put-up available in Gray only.

*Red jacket only suitable for Fire Alarm applications.

Jacket sequentially marked at 2 ft. intervals.

For additional selection of Belden® Security, Alarm and Communications Cables, refer to the New Generation® Cables section of this catalog.

21 • Residential Cables



Speaker Cable

High-Strand Multi-conductor Audio Cables

Description	Part No.	UL NEC/ C(UL) CEC Type	No. of Cond.	Color Code	Standard Lengths		Standard Unit Weight		Insulation Thickness		Outer Jacket Thickness		Nominal OD	
					Ft.	m	Lbs.	kg	Inch	mm	Inch	mm	Inch	mm

High-Strand • 16 AWG Stranded (65x34) Bare High-conductivity ETP Copper Conductors • Highly Stranded for Ultra Flexibility • Rip Cord

High-Grade PVC Insulation • PVC Jacket (Available in Blue, Green, White, Black or Gray)

75°C  Rip Cord	5200UP	NEC: CM	2	Black, White	U-500	U-152.4	14.5	6.6	.015	.38	.015	.38	.208	5.28
					500	152.4	14.5	6.6						
					U-1000	U-304.8	28.0	12.7						
					1000	304.8	28.0	12.7						

Jacket sequentially marked at 2 ft. intervals.

75°C  Rip Cord	5202UP	NEC: CM	4	Black, White, Red, Green	U-500	U-152.4	25.5	11.6	.015	.38	.015	.38	.244	6.20
					500	152.4	26.0	11.8						
					U-1000	U-304.8	49.0	22.2						
					1000	304.8	51.0	23.2						

Jacket sequentially marked at 2 ft. intervals.

High-Strand • 14 AWG Stranded (42x30) Bare High-conductivity ETP Copper Conductors • Highly Stranded for Ultra Flexibility • Rip Cord

High-Grade PVC Insulation • PVC Jacket (Available in Blue, Green, White, Black or Gray)

75°C  Rip Cord	5100UP	NEC: CL3	2	Black, White	U-500	U-152.4	21.0	9.5	.020	.51	.015	.38	.260	6.60
					500	152.4	22.5	10.2						
					U-1000	U-304.8	41.0	18.6						
					1000	304.8	43.0	19.5						

Jacket sequentially marked at 2 ft. intervals.

High-Strand • 12 AWG Stranded (65x30) Bare High-conductivity ETP Copper Conductors • Highly Stranded for Ultra Flexibility • Rip Cord

High-Grade PVC Insulation • PVC Jacket (Available in Blue, Green, White, Black or Gray)

75°C  Rip Cord	5000UP	NEC: CL3	2	Black, White	U-500	U-152.4	31.0	14.1	.020	.51	.018	.46	.302	7.67
					500	152.4	32.5	14.7						
					U-1000	U-304.8	64.0	29.1						
					1000	304.8	64.0	29.1						

Jacket sequentially marked at 2 ft. intervals.

High-Strand • 10 AWG Stranded (65x28) Bare High-conductivity ETP Copper Conductors • Highly Stranded for Ultra Flexibility

High-Grade PVC Insulation • Gray PVC Jacket

75°C  Rip Cord	5T00UP	NEC: CL2 Audio Use Only	2	Black, White	500	152.4	49.5	22.5	.020	.51	.026	.66	.356	9.04
					1000	304.8	96.0	43.6						

Jacket sequentially marked at 2 ft. intervals.

Speaker Cable

High-Conductivity Electrolytic Tough Pitch (ETP) Copper Speaker Cables

Description	Part No.	UL NEC/ C(UL) CEC Type	No. of Cond.	Standard Lengths		Standard Unit Weight		Insulation Thickness		Nominal OD	
				Ft.	m	Lbs.	kg	Inch	mm	Inch	mm

16 AWG Stranded (26x30) ETP High-conductivity Copper Conductors • Parallel: (1) Tinned, (1) Bare

PVC Insulation • Clear PVC Jacket

Parallel Zip Construction 300V 60°C	9716		2	U-1000 1000	U-304.8 304.8	27.0 26.0	12.3 11.8	.027	.69	.115 x .230	2.92 x 5.84
--	-------------	--	---	----------------	------------------	--------------	--------------	------	-----	-------------------	-------------------

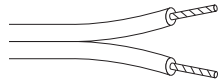

14 AWG Stranded (19x27) ETP High-conductivity Copper Conductors • Parallel: (1) Tinned, (1) Bare

PVC Insulation • Clear PVC Jacket

Parallel Zip Construction 60°C	9717		2	U-1000 1000	U-304.8 304.8	42.0 42.0	19.1 19.1	.035	.89	.146 x .292	3.71 x 7.42
-----------------------------------	-------------	--	---	----------------	------------------	--------------	--------------	------	-----	-------------------	-------------------

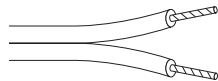

12 AWG Stranded (65x30) ETP High-conductivity Copper Conductors • Parallel: (1) Tinned, (1) Bare

PVC Insulation • Clear PVC Jacket

Parallel Zip Construction 60°C	9718		2	500 1000	152.4 304.8	33.0 66.0	15.0 30.0	.045	1.14	.185 x .370	4.70 x 9.40
-----------------------------------	-------------	--	---	-------------	----------------	--------------	--------------	------	------	-------------------	-------------------

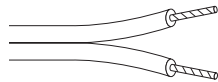

Alarm, Security and Speaker Cable / Shielded Audio Cable

Multi-conductor Cables for Residential, Light Commercial and Institutional Applications, AES/EBU Digital Audio Cables, and Audio and Control Interconnect Cables

Description	Part No.	UL NEC/ C(UL) CEC Type	No. of Cond.	Color Code	Standard Lengths		Standard Unit Weight		Insulation Thickness		Outer Jacket Thickness		Nominal OD	
					Ft.	m	Lbs.	kg	Inch	mm	Inch	mm	Inch	mm

Multi-conductor • 22 AWG Stranded (7x30) Bare Copper Conductors

Non-Plenum • Polypropylene Insulation • PVC Jacket (Beige, Brown, Orange, Yellow, Green, Blue, Purple, Gray or Natural)

	5500UG 300V 75°C	NEC:	2	Black, Red	C-500	C-152.4	3.5	1.6	.006	.15	.015	.38	.114	2.90
		CM			U-500	U-152.4	5.0	2.3						
		CEC:			C-1000	C-304.8	7.0	3.2						
		CM FT1			U-1000	U-304.8	9.0	4.1						

Jacket sequentially marked at 2 ft. intervals.

	5502UG 300V 75°C	NEC:	4	Black, Red, White, Green	C-500	C-152.4	6.5	3.0	.006	.15	.015	.38	.131	3.33
		CM			U-500 *	U-152.4	7.5	3.4						
		CEC:			C-1000	C-304.8	13.0	5.9						
		CM FT1			U-1000	U-304.8	14.0	6.4						

*U-500 ft. put-up available in Gray or White only.
Jacket sequentially marked at 2 ft. intervals.

Multi-conductor • 18 AWG Stranded (7x26) Bare Copper Conductors

Non-Plenum • Polypropylene Insulation • PVC Jacket (Available in Black, Gray or Natural)

	5300UG 300V 75°C	NEC:	2	Black, Red	C-500	C-152.4	7.5	3.4	.006	.15	.015	.38	.148	3.76
		CM			U-500	U-152.4	8.5	3.9						
		CEC:			U-1000	U-304.8	16.0	7.3						
		CM FT1												

Jacket sequentially marked at 2 ft. intervals.

Shielded Audio Cable

Description	Part No.	UL NEC/ C(UL) CEC Type	No. of Pairs	Color Code	Standard Lengths		Standard Unit Weight		Nom. DCR		Nominal OD		Nom. Imp. (Ω)	Nom. Vel. of Prop.	Nom. Capacitance			
					Ft.	m	Lbs.	kg	Cond.	Shield	Inch	mm			* pF/Ft.	* pF/m	** pF/Ft.	** pF/m

AES/EBU Digital Audio • 24 AWG Stranded (7x32) TC Conductors • Twisted Pairs • Overall Beldfoil® Shield (100% Coverage) • 24 AWG Drain Wire
Datalene® Insulation • Gray or Purple PVC Jacket

	1800B 60°C	NEC:	1	Black, Red	500 *	152.4	8.0	3.6	23.7Ω/M'	18.9Ω/M'	.177	4.50	110	76%	12	39	26	85		
		CMG			U-1000	U-304.8	17.0	7.7	77.7Ω/km	62.0Ω/km										
		CEC:			1000	304.8	16.0	7.3												
		CMG FT4			5000 *	1524.0	90.0	40.9												

*500 ft. put-up available in Gray only. 5000 ft. put-up available in Purple only.
The jacket and shield are bonded so both can be removed with automatic stripping equipment.

For cross-connect use with 1803F (et al.)
Digital Audio Snake Cables, see page 19.28
For Plenum version of 1800B, see 1801B.

Audio and Control Interconnect • 22 AWG Stranded (7x30) TC Conductors • Twisted Pairs • 24 AWG Stranded TC Drain Wire

Polypropylene Insulation • Chrome PVC Jacket (Pairs Cabled on Common Axis to Reduce Diameter)

	8723 60°C	NEC:	2	Red/Black, Green/White	100	30.5	2.3	1.0	14.7Ω/M'	15.0Ω/M'	.160	4.06	45	66%	35	115	62	203		
		CM			U-500	U-152.4	10.5	4.8	48.5Ω/km	49.2Ω/km										
		CEC:			500	152.4	10.0	4.5												
		CM			U-1000	U-304.8	20.0	9.1												
					1000	304.8	20.0	9.1												
					1640	499.9	32.8	14.9												
					U-2000	U-609.6	38.0	17.2												
					2000	609.6	40.0	18.2												
					3280	999.7	65.6	29.8												
					5000	1524.0	95.0	43.2												
	10000	3048.0	200.0	90.9																

Pairs Individually Shielded with Beldfoil® (100% Coverage)
For Plenum versions of 8723, see 88723, 87723 or 82723.

BC = Bare Copper • DCR = DC Resistance • TC = Tinned Copper

For additional selection of Belden® Audio Cables, refer to the Broadcast Cables section of this catalog.

*Capacitance between conductors.

**Capacitance between one conductor and other conductors connected to shield.

Datalene insulation features include low dielectric constant and a dissipation factor for high-speed, low-distortion data handling. Physical properties include good crush resistance and light weight.



Surveillance Coax

Coaxial and Composite Cables for Surveillance and CCTV Applications

Description	Part No.	UL NEC/ C(UL) CEC Type	Standard Lengths		Standard Unit Weight		Nominal DCR		Nominal Core OD		Nominal OD		Nom. Imp. (Ω)
			Ft.	m	Lbs.	kg	Conductor	Shielding	Inch	mm	Inch	mm	

Coaxial • RG-59/U Type • 20 AWG Solid Bare Copper Conductor • Bare Copper Braid Shield (95% Coverage)

Foam Polyolefin Insulation • PVC Jacket (Available in Black or White)

75°C	543945	NEC:	U-500	U-152.4	13.0	6.0	10.0Ω/M'	3.5Ω/M'	.145	3.68	.232	5.89	75
		CM	500	152.4	16.0	7.3	32.8Ω/km	11.5Ω/km					
		CEC:	U-1000	U-304.8	32.0	14.5							
		CM FT1	1000	304.8	34.0	15.4							

Jacket sequentially marked at 2 ft. intervals.

Composite • RG-59/U Type, 20 AWG Coax Solid BC Conductor • BC Braid Shield (95% Coverage) • **18 AWG** UTP Stranded (7x26) BC Conductor

Foam Polyolefin Insulation (Coax) • PVC Insulation (Pair, Color Code: Red, Black) • PVC Jacket (Available in Black or White)

Siamese Configuration	549945	NEC:	500	152.4	30.0	13.6	Coax:	3.5Ω/M'	Coax OD:	.232	5.89	75
75°C		CM	1000	304.8	60.0	27.3	10.0Ω/M'	11.5Ω/km	.145	3.68	x	x
		CEC:						32.8Ω/km		Pair OD:	.460	11.68
		CM FT1						Each Pair:	.046	1.17		

Jacket sequentially marked at 2 ft. intervals.

Composite • RG-6/U Type, 18 AWG Coax Solid BC Conductor • BC Braid Shield (95% Coverage) • **18 AWG** UTP Stranded (7x26) BC Conductor

Foam Polyolefin Insulation (Coax) • PVC Insulation (Pair, Color Code: Red, Black) • Black PVC Jacket

Siamese Configuration	539945	NEC:	500	152.4	34.0	15.5	Coax:	3.5Ω/M'	Coax OD:	.266	6.76	75
75°C		CM	1000	304.8	69.0	31.3	10.0Ω/M'	11.5Ω/km	.180	4.57	x	x
		CEC:						32.8Ω/km		Pair OD:	.500	12.70
		CM FT1						Each Pair:	.066	1.68		

Jacket sequentially marked at 2 ft. intervals.

BC = Bare Copper • DCR = DC Resistance • UTP = Unshielded Twisted Pair

For additional selection of Belden® Security and CCTV Cables, refer to the New Generation® and Coaxial Cables sections of this catalog.

Tools and Accessories

Compression and Cable Prep Tools

One-piece, Male Connectors for Mini Hi-Res Coaxial Cable

HCST Cable Prep Tool

Product Description

Cable stripping tool for use with RG-6, RG-59, Mini RG-59 and RGB Coaxial cable.
Belden Part No. HCST 000001



HCCT Compression Tool

Product Description

Suitable for use with BNC, RCA and F Connectors including Belden 1B25A, 1R25A, HC2920A and HC22910A connectors.
Belden Part No. HCCT 000020

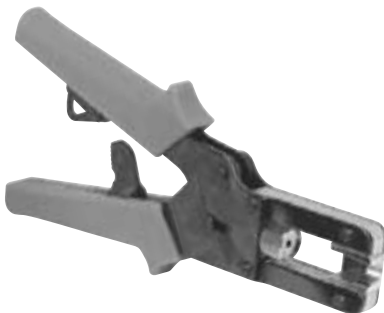

Compatible Cables

25 AWG Solid Center Conductor
Miniature Hi-Res RGB Coax Cables

	CMR	CMP
1 Coax	1281R	1282P

Banana Peel® Spline Constructions

3 Coax RGB	1281S3	1282S3
4 Coax RGBS	1281S4	1282S4
5 Coax RGBHV	1281S5	1282S5
6 Mini Coaxes	1281S6	1282S6

Jacketed Constructions

3 Coax RGB	1277R	1277P
4 Coax RGBS	1278R	1278P
5 Coax RGBHV	1279R	1279P
6 Mini Coaxes	1280R	1280P

75-Ohm BNC Connectors

Product Description

One-piece male connector for 25 AWG Mini Hi-Res Coaxial cable. Compression attachment method for contact and body.
Use Belden HCCT Compression Tool.

Belden Part No. 1B25A (Nickel-plated Body)
HC2920A (Gold-plated Body)

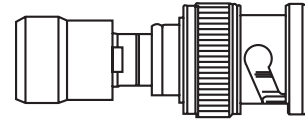

Specifications

Impedance	75Ω
Frequency Range	DC–3.0 GHz (dependent upon Cable limitations)
Insertion Loss	<.1 dB @ 1 GHz
Return Loss	>20 dB; 5–1000 MHz
Cable Retention Force	>40 lbs.
Center Conductor Contact Plating	>.0003" Gold on Beryllium Copper
Center Pin Retention	>150 grams
Mating Style	2-stud Bayonet Lock
Current Rating	5 amp
Max. Working Voltage	300 Vrms
Body Material	Brass
Body Plating	Nickel or Gold
RFI	>100 dB
Cable Attachment Method	Compression Style; 1-piece

RCA Connectors

Product Description

One-piece male connector for 25 AWG Mini Hi-Res Coaxial cable. Compression attachment method for contact and body.
Use Belden HCCT Compression Tool.

Belden Part No. 1R25A (Nickel-plated Body)
HC2910A (Gold-plated Body)

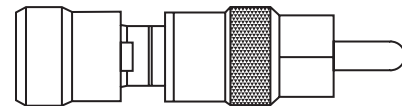

Specifications

Impedance	For 75Ω cables (75Ω style)
Cable Retention Force	>40 lbs.
Center Pin Plating	Gold on Beryllium Copper
Center Pin Retention	>150 grams
Mating Style	RCA Standard Interface
Current Rating	2 amps
Max. Working Voltage	300 Vrms
Body Material	Brass
Body Plating	Nickel or Gold
Cable Attachment Method	Compression Style; 1-piece



Technical Information

22



Table of Contents

Technical Information	Page No.
Conductors	22.2–22.5
Table 1: Solid Copper Wire, American Wire Gage	22.2
Table 2: Stranded Copper Wire, American Wire Gage	22.3
Table 3: Current Ratings for Belden® Electronic Cables	22.4
Table 4: Metric/Imperial/Circular Mills/AWG Equivalents	22.5
Insulations and Jackets	22.6–22.11
Insulations: Overview	22.6
Jackets: Overview	22.6
Characteristics of Popular Insulation and Jacket Compounds	22.7
Table 4: Comparative Properties of Plastic Compounds	22.8
Table 5: Comparative Properties of Fluoropolymers	22.9
Table 6: Comparative Properties of Rubber Insulations	22.10
Table 7: Nominal Temperature Ranges	22.11
Shielding and Armoring	22.12–22.14
Shielding: Overview	22.12
Characteristics of Belden Shield Types	22.13
Foil Shields	22.13
Braid Shields	22.13
Spiral/Serve Shields	22.13
“French Braid” Shields	22.13
Combination Shields	22.13
Shield Types: Application Guide	22.14
Table 8: Relative Cost Comparison of Shield Types	22.14
Table 9: Shield Performance Comparison	22.14
Armoring: Overview	22.14
Metric Conversions	22.15–22.16
Table 10: Temperature Conversions	22.15
Table 11: Distance and Weight Conversion Formulas	22.15
Table 12: Conductor Size Equivalents	22.16
Belden Color Code Charts	22.17–22.19
Cable Standards Reference Guide	22.20
National Electrical Code (NEC)	22.20
Impact of NEC	22.20
Intended Uses of Appliance Wiring Materials (AWM)	22.20
C(UL) Certifications	22.20
FT1 Vertical Flame Test	22.20
FT4 Vertical Flame Test — Cables in Trays	22.20
FT6 Horizontal Flame and Smoke Test	22.20
NEC Cable Substitution Chart	22.21
Canadian Electrical Code (CEC) Substitution Chart	22.22
Terms of Use of Master Catalog	22.22
Environmental Regulations and Compliance	22.23
Cable Packaging	22.24
UnReel®	22.24
Reel-in-a-Box	22.24
Glossary	22.25–22.36

The information, graphs, tables and illustrations presented in this section are provided to assist Belden customers with the selection of the most appropriate cable for their application. For further assistance, contact Belden Technical Support at: **1-800-BELDEN-1**.

Conductors

Table 1: Solid Copper Wire, American Wire Gage

Gage (AWG)	Nominal OD		Nominal Circular MIL Area	Nominal Weight (Lbs. per 1000 Ft.)	Nominal Resistance @ 68°F (Ω /1000 Ft.)
	Inches	mm			
10	.1019	2.60	10380.0	31.43	.9989
11	.0907	2.30	8234.0	24.92	1.260
12	.0808	2.05	6530.0	19.77	1.588
13	.0720	1.83	5178.0	15.68	2.003
14	.0641	1.63	4107.0	12.43	2.525
15	.0571	1.45	3260.0	9.858	3.184
16	.0508	1.29	2583.0	7.818	4.016
17	.0453	1.15	2050.0	6.200	5.064
18	.0403	1.02	1620.0	4.917	6.385
19	.0359	.912	1200.0	3.899	8.051
20	.0320	.813	1020.0	3.092	10.15
21	.0285	.724	812.1	2.452	12.80
22	.0253	.643	640.4	1.945	16.14
23	.0226	.574	511.5	1.542	20.36
24	.0201	.511	404.0	1.223	25.67
25	.0179	.455	320.4	.9699	32.37
26	.0159	.404	253.0	.7692	40.81
27	.0142	.361	201.5	.6100	51.47
28	.0126	.320	159.8	.4837	64.90
29	.0113	.287	126.7	.3836	81.83
30	.0100	.254	100.5	.3042	103.2
31	.0089	.226	79.7	.2413	130.1
32	.0080	.203	63.21	.1913	164.1
33	.0071	.180	50.13	.1517	206.9
34	.0063	.160	39.75	.1203	260.9
35	.0056	.142	31.52	.09542	331.0
36	.0050	.127	25.00	.07568	414.8
37	.0045	.114	19.83	.0613	512.1
38	.0040	.102	15.72	.04759	648.6
39	.0035	.089	12.20	.03774	847.8
40	.0031	.079	9.61	.02993	1080.0

Information from National Bureau of Standards Copper Wire Tables — Handbook 100.

Unparalleled Performance

Belden is one of only a very few cable manufacturers to draw and anneal its own conductors. This is a time-consuming process, but it allows us to ensure signal integrity, as well as proper physical characteristics.

In addition, the standards under which we design and manufacture our fiber optic cabling are among the strictest in the industry. The result is a comprehensive offering of products which give unparalleled performance and can satisfy your most demanding operating and environmental challenges.

Conductors

Table 2: Stranded Copper Wire, American Wire Gage

Gage (AWG)	Stranding (Nom. AWG)	Min. Average OD of Strand	Approximate OD		ASTM Min. Circular MIL Area	Min. Weight (Lbs./1000 Ft.)	Max. Resistance* @ 68°F (Ω/1000 Ft.)
			Inches	mm			
36	7x44	.0019	.006	.152	25	.076	414.8
34	7x42	.0024	.0075	.191	39.7	.121	260.9
32	7x40	.0030	.0093	.236	64	.195	164.1
32	19x44	.0018	.010	.254	64	.195	164.1
30 ♦	7x38	.0038	.012	.305	100	.304	112.0
30	19x42	.0023	.012	.305	100	.304	112.0
28 ♦	7x36	.0048	.015	.381	159	.484	70.7
28 ♦	19x40	.0029	.016	.406	159	.484	70.7
27	7x35	.0054	.017	.432	202	.614	55.6
26 ♦	7x34	.0060	.019	.483	253	.770	44.4
26	10x36	.0050	.021	.533	253	.770	44.4
26 ♦	19x38	.0036	.020	.508	253	.770	44.4
24 ♦	7x32	.0076	.024	.610	404	1.229	27.7
24	10x34	.0064	.024	.610	404	1.229	27.7
24 ♦	19x36	.0046	.024	.610	404	1.229	27.7
24 ♦	42x40	.0031	.023	.584	404	1.229	27.7
22 ♦	7x30	.0096	.030	.762	640	1.947	17.5
22 ♦	19x34	.0058	.031	.787	640	1.947	17.5
22	26x36	.0050	.030	.762	640	1.947	17.5
20 ♦	7x28	.0126	.038	.965	1020	3.103	10.9
20	10x30	.0101	.037	.940	1020	3.103	10.9
20 ♦	19x32	.0073	.037	.940	1020	3.103	10.9
20	26x34	.0063	.036	.914	1020	3.103	10.9
20 ♦	42x36	.0049	.038	.965	1020	3.103	10.9
18 ♦	7x26	.0152	.048	1.22	1620	4.93	6.92
18	16x30	.0101	.047	1.19	1620	4.93	6.92
18 ♦	19x30	.0092	.049	1.24	1620	4.93	6.92
18 ♦	42x34	.0062	.047	1.19	1620	4.93	6.92
18 ♦	65x36	.0050	.047	1.19	1620	4.93	6.92
16 ♦	7x24	.0192	.060	1.52	2580	7.85	4.35
16 ♦	19x29	.0117	.058	1.47	2580	7.85	4.35
16	26x30	.0100	.059	1.50	2580	7.85	4.35
16 ♦	65x34	.0063	.059	1.50	2580	7.85	4.35
16	105x36	.0050	.059	1.50	2580	7.85	4.35
14 ♦	7x22	.0242	.076	1.93	4110	12.50	2.73
14 ♦	19x26	.0147	.071	1.80	4110	12.50	2.73
14 ♦	42x30	.0099	.075	1.91	4110	12.50	2.73
14	105x34	.0063	.075	1.91	4110	12.50	2.73
12 ♦	7x20	.0305	.096	2.44	6530	19.86	1.71
12 ♦	19x25	.0185	.093	2.36	6530	19.86	1.71
12 ♦	65x30	.0100	.095	2.41	6530	19.86	1.71
12	165x34	.0063	.095	2.41	6530	19.86	1.71
10	37x26	.0167	.115	2.92	10380	31.58	1.08
10	65x28	.0126	.120	3.05	10380	31.58	1.08
10	105x30	.0099	.118	3.00	10380	31.58	1.08

*AWG 10 through 30 per UL Subject 13.

Belden has standardized on the stranded conductors used in the design of all Belden® products. These preferred constructions, based on standard industry practices, are marked with a ♦ symbol.

Conductors

Table 3: Current Ratings for Belden® Electronic Cables

The maximum continuous current rating for an electronic cable is limited by conductor size, number of conductors contained within the cable, maximum temperature rating of the cable, and environmental conditions such as ambient temperature and air flow. To use the current capacity chart, first determine conductor size, temperature rating, and number of conductors from the applicable product description for the cable of interest.

Next, find the current value on the chart for the proper temperature rating and conductor size. To calculate the maximum current rating/conductor, multiply the chart value by the appropriate conductor factor. The chart assumes cable is surrounded by still air at an ambient temperature of 25°C. Current values are in RMS Amperes and are valid for copper conductors only. For conditions other than specified, contact Belden Technical Support at: **1-800-BELDEN-1**.

Note: Current ratings are intended as general guidelines for low power electronic communications and control applications. Current ratings for power applications generally are set by regulatory agencies such as UL, CSA, NEC, and others.

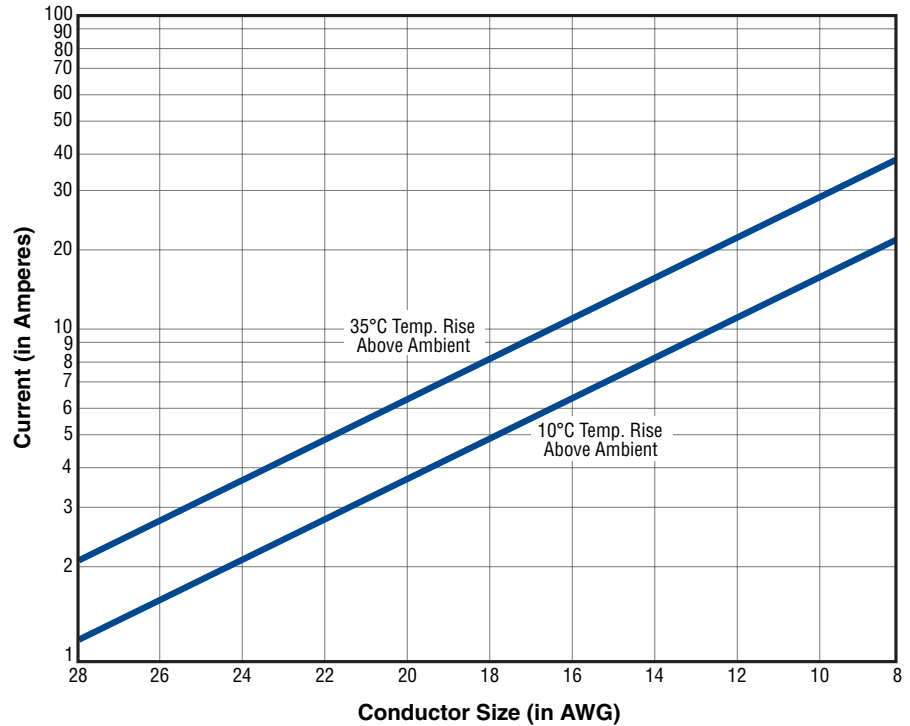

Current Ratings

No. of Conductors*	Factor
1	1.6
2 to 3	1.0
4 to 5	.8
6 to 15	.7
16 to 30	.5

*Do not count shields unless used as conductor.

Conductors

Table 4: Metric / Imperial / AWG Equivalents

(Square Millimeters / Square Inches / Circular Mils / AWG)

Sq. mm	Sq. in.	Cir. mils	AWG	Sq. mm	Sq. in.	Cir. mils	AWG	Sq. mm	Sq. in.	Cir. mils	AWG
1000	1.550	1974000		55	.0853	108570		5.00	.00775	9870	
975	1.511	1924700		—	—	105600	1/0	4.75	.00736	9377	
950	1.472	1875300		50	.0775	98700		4.50	.00698	8883	
925	1.434	1826000		45	.0698	88830		4.25	.00659	8390	
900	1.395	1776600		—	—	83690	1	—	—	8230	11
875	1.356	1727300		40	.0620	78960		4.00	.00620	7896	
850	1.317	1677900		35	.0542	69090		3.75	.00581	7403	
825	1.279	1628600		—	—	66360	2	3.50	.00542	6909	
800	1.240	1579200		30	.0465	59220		—	—	6530	12
775	1.201	1529900		—	—	52620	3	3.25	.00504	6416	
750	1.163	1480500		25	.0388	49350		3.00	.00465	5922	
725	1.124	1431200		—	—	41740	4	2.75	.00426	5429	
700	1.085	1381800		20.0	.0310	39480		—	—	5180	13
675	1.046	1332500		19.5	.0302	38490		2.50	.00388	4935	
650	1.008	1283100		19.0	.0294	37510		2.25	.00349	4422	
625	.969	1233800		18.5	.0287	36520		—	—	4110	14
600	.930	1184400		18.0	.0279	35530		2.00	.00310	3948	
575	.891	1135100		17.5	.0271	34550		1.75	.00271	3455	
550	.853	1085700		17.0	.0264	33560		—	—	3260	15
525	.814	1036400		—	—	33090	5	1.50	.00233	2961	
500	.775	987000		16.5	.0256	32560		—	—	2580	16
475	.736	937700		16.0	.0248	31580		1.25	.00194	2468	
450	.698	888300		15.5	.0240	30600		—	—	2050	17
425	.659	839000		15.0	.0233	29610		1.00	.00155	1974	
400	.620	789600		14.5	.0225	28620		.90	.00140	1777	
375	.581	740300		14.0	.0217	27640		—	—	1620	18
350	.542	690900		13.5	.0209	26650		.80	.00124	1579	
325	.504	641600		—	—	26420	6	.75	.00116	1481	
300	.465	592200		13.0	.0201	25660		.70	.00109	1382	
275	.426	542900		12.5	.0194	24680		—	—	1290	19
250	.388	493500		12.0	.0186	23690		.60	.00093	1184	
225	.349	444200		11.5	.0178	22700		—	—	1029	20
200	.310	394800		11.0	.0171	21710		.50	.000775	987	
175	.271	345500		—	—	20820	7	—	—	—	
150	.233	296100		10.5	.0163	20730		—	—	—	
125	.1938	246800		10.0	.0155	19740		9.5	.01472	18753	
—	—	211600	4/0	9.5	.01472	18753		9.0	.01395	17766	
100	.1550	197400		8.5	.01317	16779		8.5	.01317	16779	
95	.1472	187530		—	—	16510	8	—	—	16510	8
90	.1395	177660		8.0	.01240	15792		8.0	.01240	15792	
—	—	167800	3/0	7.5	.01163	14805		7.5	.01163	14805	
85	.1317	167790		7.0	.01085	13818		7.0	.01085	13818	
80	.1240	157920		—	—	13090	9	—	—	13090	9
75	.1163	148050		6.5	.01008	12831		6.5	.01008	12831	
70	.1085	138180		6.0	.00930	11844		6.0	.00930	11844	
—	—	133100	2/0	5.5	.00853	10857		5.5	.00853	10857	
65	.1008	128310		—	—	10380	10	—	—	10380	10
60	.0930	118440		—	—	—		—	—	—	

To Convert:	Multiply by:
Inches to millimeters	25.4
Millimeters to inches	.03937

Insulations and Jackets

Overview

Insulations

Belden expends a great amount of time and effort to formulate its own insulations. As a result, Belden® insulations provide superior performance under a variety of hostile environmental conditions. Belden cables are available in UL Listed and CSA Approved insulation compounds.

Among the insulations we utilize are:

- **Polyethylene**
- **Polyvinyl-chloride (PVC)**
- **Polypropylene**

Also available are:

- **Datalene®** — For computer and data transmission. Datalene is crush resistant, lightweight, and offers good performance characteristics over a wide range of temperatures.
- **Teflon® Insulated Plenum & High-Temperature Cables** — For data communications, instrumentation/control, and other commercial and industrial applications. Plenum cables eliminate the need for conduit and reduce installation time.

Jackets

Belden electronic cables are manufactured in a wide selection of jacketing materials.

- **Flamarrest®** — A Belden jacketing innovation, Flamarrest is a low-smoke, flame retardant compound that is five times more flexible than fluorocopolymer. Cables jacketed with Flamarrest are cost efficient and easy to install.

Also included in our wide selection of jacketing compounds are:

- **Polyvinyl-chloride**
- **Polyethylene**
- **Polyurethane**
- **Teflon**
- **Tefzel®**
- **Halar®**
- **Neoprene**
- **EPDM**
- **Hypalon®**
- **Silicone rubber**
- **Natural rubber**

Special compounds and variations of standard compounds are used as well.

Teflon, Tefzel and Hypalon are DuPont trademarks.
Halar is an Ausimont Corporation trademark.

Insulations and Jackets

Typical Characteristics of Popular Insulation and Jacketing Compounds

EPDM

EPDM (ethylene-propylene-diene elastomer) is a chemically cross-linked elastomer with excellent flexibility at high and low temperatures (150° to -55°C). It has good insulation resistance and dielectric strength, as well as excellent abrasion resistance and mechanical properties. EPDM also has better cut-through resistance than Silicone rubber, which it replaces in some applications.

EPDM is compatible with most varnishes, but after the dip and bake cycle varnish tends to adhere to the insulation (because EPDM, unlike some rubber insulations, does not exude oils or waxes). As lead wires are pulled apart for termination, the varnish cracks, sometimes breaking the insulation.

To resolve this problem, a stearic solution is applied to the lead wire during the put-up process. This ensures that rigid varnish does not cause EPDM insulation to rupture when the wire is terminated.

Field evaluations by numerous users reveal that the coated EPDM has excellent varnish resistance at least equal to synthetic elastomers, cross-link polyethylene, or Silicone glass braid in dip and bake systems.

Flamarrest®

Flamarrest is a plenum grade chloride-based jacketing material with low smoke and low flame spread properties. Cables jacketed with Flamarrest meet the ANSI/NFPA Standard 262-1985 (UL910), Plenum Cable Flame Test.

Halar®

Thermoplastic fluoropolymer material with excellent chemical resistance, electrical properties, thermal characteristics, and impact resistance. The temperature rating is -70°C to 150°C.

Neoprene

The temperature range of this material can vary from -55°C to 90°C. The actual range would depend on the formulation used. Neoprene is both oil-resistant and sunlight-resistant, making it ideal for many outdoor applications. The most stable colors are Black, Dark Brown, and Gray. The electrical properties are not as good as other insulation materials. Because of this, thicker insulation should be used. Typical designs where this material is used are lead wire insulation and cable jackets.

Polyethylene (Solid and Foamed)

A very good insulation in terms of electrical properties. Low dielectric constant, a stable dielectric constant over all frequencies, very high insulation resistance. In terms of flexibility, polyethylene can be rated stiff to very hard, depending on molecular weight and density—low density being the most flexible, with high-density, high-molecular weight formulation being very hard. Moisture resistance is rated excellent. Black and specially formulated colored versions have excellent weather resistance. The dielectric constant is 2.3 for solid insulation and typically 1.64 for foam designs. Flame retardant formulations are available with dielectric constants ranging from about 1.7 for foam flame retardant to 2.58 for solid flame retardant polyethylene.

Polypropylene (Solid and Foam)

Similar in electrical properties to polyethylene. This material is primarily used as an insulation material. Typically, it is harder than polyethylene. This makes it suitable for thin wall insulations. UL maximum temperature rating may be 60°C, 80°C or 105°C. The dielectric constant is 2.25 for solid and typically 1.55 for foam designs.

Polyurethane

This material is used primarily as a cable jacket material. It has excellent oxidation, oil, and ozone resistance. Some formations also have good flame resistance. It is a hard material with excellent abrasion resistance. It has outstanding "memory" properties, making it an ideal jacket material for retractile cords.

PVC

Sometimes referred to as vinyl or polyvinylchloride. Extremely high or low temperature properties cannot be found in one formulation. Certain formulations may have -55°C to 105°C rating. Other common vinyls may have -20°C to 60°C. There are many formulations for the variety of different applications. The many varieties of PVC also differ in pliability and electrical properties. The price range can vary accordingly. Typical dielectric constant values can vary from 3.5 to 6.5.

Rubber

The description of rubber normally includes natural rubber and SBR compounds. Both of these materials can be used for insulations and jackets. There are many formulations of these basic materials. Each formulation is for a specific application. Some formulations are suitable for -55°C minimum, while others are suitable for 75°C maximum.

Silicone

This is a very soft insulation which has a temperature range from -80°C to 200°C. It has excellent electrical properties plus ozone resistance, low moisture absorption, weather resistance, and radiation resistance. It typically has low mechanical strength and poor scuff resistance.

Teflon®

This material has excellent electrical properties, temperature range and chemical resistance. It is not suitable where subjected to nuclear radiation and does not have good high voltage characteristics. FEP Teflon is extrudable in a manner similar to PVC and polyethylene. This means that long wire and cable lengths are available. TFE Teflon is extrudable in a hydraulic ram type process. Lengths are limited due to amount of material in the ram, thickness of the insulation, and preform size. TFE must be extruded over a silver- or nickel-coated wire. The nickel- and silver-coated designs are rated 260°C and 200°C maximum, respectively. The cost of Teflon is approximately 8 to 10 times more per pound than PVC compounds.

Tefzel®

Fluorocopolymer thermoplastic material having excellent electrical properties, heat resistance, chemical resistance, toughness, radiation resistance, and flame resistance. The temperature rating is -65°C to 150°C.

Teflon and Tefzel are DuPont trademarks.
Halar is a Solvay Solexis trademark.

Insulations and Jackets

Table 4: Comparative Properties of Plastic Insulating and Jacketing Compounds

Properties	PVC	LDPE	Cellular Polyethylene	HDPE	Polypropylene	Cellular Polypropylene	PUR	Nylon	CPE	Flamarrest®
Oxidation Resistance	E	E	E	E	E	E	E	E	E	E
Heat Resistance	G-E	G	G	E	E	E	G	E	E	G-E
Oil Resistance	F	G-E	G	G-E	F	F	E	E	E	F
Low-Temperature Flexibility	P-G	E	E	E	P	P	G	G	E	P-G
Weather, Sun Resistance	G-E	E	E	E	E	E	G	E	E	G
Ozone Resistance	E	E	E	E	E	E	E	E	E	E
Abrasion Resistance	F-G	G	F	E	F-G	F-G	O	E	E-O	F-G
Electrical Properties	F-G	E	E	E	E	E	P	P	E	G
Flame Resistance	E	P	P	P	P	P	P	P	E	E
Nuclear Radiation Resistance	F	G-E	G	G-E	F	F	G	F-G	O	F
Water Resistance	F-G	E	E	E	E	E	P-G	P-F	O	F
Acid Resistance	G-E	G-E	G-E	E	E	E	F	P-F	E	G
Alkali Resistance	G-E	G-E	G-E	E	E	E	F	E	E	G
Aliphatic Hydrocarbons Resistance (Gasoline, Kerosene, etc.)	P	G-E	G	G-E	P-F	P	P-G	G	E	P
Aromatic Hydrocarbons Resistance (Benzol, Toluol, etc.)	P-F	P	P	P	P-F	P	P-G	G	G-E	P-F
Halogenated Hydrocarbons Resistance (Degreaser Solvents)	P-F	G	G	G	P	P	P-G	G	E	P-F
Alcohol Resistance	P-F	E	E	E	E	E	P-G	P	E	G
Underground Burial	P-G	G	N/A	E	N/A	N/A	G	P	E-O	P

CPE = Chlorinated Polyethylene • HDPE = High-density Polyethylene • LDPE = Low-density Polyethylene • PUR = Polyurethane

These ratings are based on average performance of general purpose compounds.
Any given property can usually be improved by the use of selective compounding.

Legend

P	Poor
F	Fair
G	Good
E	Excellent
O	Outstanding

Insulations and Jackets

Table 5: Comparative Properties of Fluoropolymer Insulating and Jacketing Compounds

Properties	FEP Teflon®	Tefzel® (ETFE)	PTFE Teflon	Solef® / Kynar® (PVDF) / PVF	Halar® (E-CTFE)
Oxidation Resistance	O	E	O	O	O
Heat Resistance	O	E	O	O	O
Oil Resistance	O	E	E-O	E	O
Low-Temperature Flexibility	O	E	O	F	O
Weather, Sun Resistance	O	E	O	E-O	O
Ozone Resistance	E	E	O	E	E
Abrasion Resistance	E	E	O	E	E
Electrical Properties	E	E	E	G-E	E
Flame Resistance	O	G	E	E	E-O
Nuclear Radiation Resistance	P-G	E	P	E	E
Water Resistance	E	E	E	E	E
Acid Resistance	E	E	E	G-E	E
Alkali Resistance	E	E	E	E	E
Aliphatic Hydrocarbons Resistance (Gasoline, Kerosene, etc.)	E	E	E	E	E
Aromatic Hydrocarbons Resistance (Benzol, Toluol, etc.)	E	E	E	G-E	E
Halogenated Hydrocarbons Resistance (Degreaser Solvents)	E	E	E	G	E
Alcohol Resistance	E	E	E	E	E
Underground Burial	E	E	E	E	E

These ratings are based on average performance of general purpose compounds.
Any given property can usually be improved by the use of selective compounding.

Legend	
P	Poor
F	Fair
G	Good
E	Excellent
O	Outstanding

Teflon and Tefzel are DuPont trademarks.
Halar is a Solvay Solexis trademark.
Solef is a Solvay trademark.
Kynar is a Atofina Chemical Corporation trademark.

Insulations and Jackets

Table 6: Comparative Properties of Rubber Insulations

Properties	Rubber	Neoprene	Hypalon® (Chlorosulfonated Polyethylene)	EPDM (Ethylene-Propylene- Diene Elastomer)	Silicone
Oxidation Resistance	F	G	E	E	E
Heat Resistance	F	G	E	E	O
Oil Resistance	P	G	G	P	F-G
Low-Temperature Flexibility	G	F-G	F	G-E	O
Weather, Sun Resistance	F	G	E	E	O
Ozone Resistance	P	G	E	E	O
Abrasion Resistance	E	G-E	G	G	P
Electrical Properties	G	P	G	E	G
Flame Resistance	P	G	G	P	F-G
Nuclear Radiation Resistance	F	F-G	E	G	E
Water Resistance	G	E	E	G-E	G-E
Acid Resistance	F-G	G	E	G-E	F-G
Alkali Resistance	F-G	G	E	G-E	F-G
Aliphatic Hydrocarbons Resistance (Gasoline, Kerosene, etc.)	P	G	F	P	P-F
Aromatic Hydrocarbons Resistance (Benzol, Toluol, etc.)	P	P-F	F	F	P
Halogenated Hydrocarbons Resistance (Degreaser Solvents)	P	P	P-F	P	P-G
Alcohol Resistance	G	F	G	P	G

These ratings are based on average performance of general purpose compounds. Any given property can usually be improved by the use of selective compounding.

Legend

P	Poor
F	Fair
G	Good
E	Excellent
O	Outstanding

Hypalon is a DuPont trademark.

Insulations and Jackets

Table 7: Nominal Temperature Range for Various Insulating and Jacketing Compounds

Compound	Normal Low	Normal High	Special Low	Special High
Chlorosulfonated Polyethylene (Hypalon®)	-20°C	90°C	-40°C	105°C
EPDM (Ethylene-Propylene-Diene Monomer)	-55°C	105°C	—	150°C
Neoprene	-20°C	60°C	-55°C	90°C
Polyethylene (Solid and Foamed)	-60°C	80°C	—	—
Polypropylene (Solid and Foamed)	-40°C	105°C	—	—
Rubber	-30°C	60°C	-55°C	75°C
FEP Teflon®	-70°C	200°C	—	—
PVC	-20°C	80°C	-55°C	105°C
Silicone	-80°C	150°C	—	200°C
Halar®	-70°C	150°C	—	—
Tefzel®	-65°C	150°C	—	—
PTFE Teflon	-70°C	260°C	—	—
CPE	-35°C	90°C	-45°C	105°C
Solef® / Kynar®	-20°C	150°/125°C	-40°C	150°/150°C
Flamarrest®	-20°C	75°C	—	—

Hypalon, Teflon and Tefzel are DuPont trademarks.
 Halar is a Solvay Solaxis trademark.
 Solef is a Solvay trademark.
 Kynar is a Atofina Chemical Corporation trademark.

Shielding and Armoring

Overview

Innovative Leadership

The evolution of technology maintains steady demand for sophisticated cable shielding. Belden meets that demand with innovative shielding and shield effectiveness testing methods to supply you with high quality, dependable cable.

With the creation of trademarked shield designs and patented test methods, Belden has earned a reputation for innovation and leadership that is unequalled in the wire and cable industry. In addition, Belden offers the broadest line of shielded multi-conductor, coaxial and flat cable in the industry.

Several unique Belden innovations are utilized across a wide range of shielding applications:

- **Beldfoil®** — The first aluminum/polyester foil developed for use as a cable shield. Provides 100% shield coverage for optimum protection.
- **Duofoil®** — Consists of an aluminum-poly-aluminum laminate wrapped around the cable's dielectric core. Provides 100% physical coverage, and improves shield reliability and flex life.

Belden also utilizes a number of innovative techniques to apply shielding to multi-conductor and paired cables:

- **“French Braid” Shields** — Belden's patented “French Braid” shield is a double spiral (double serve shield) with the two spirals tied together by one weave.

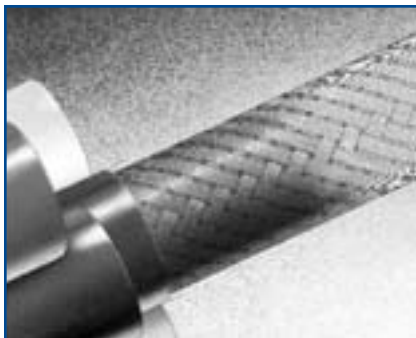

Belden's patented “French Braid” shield.

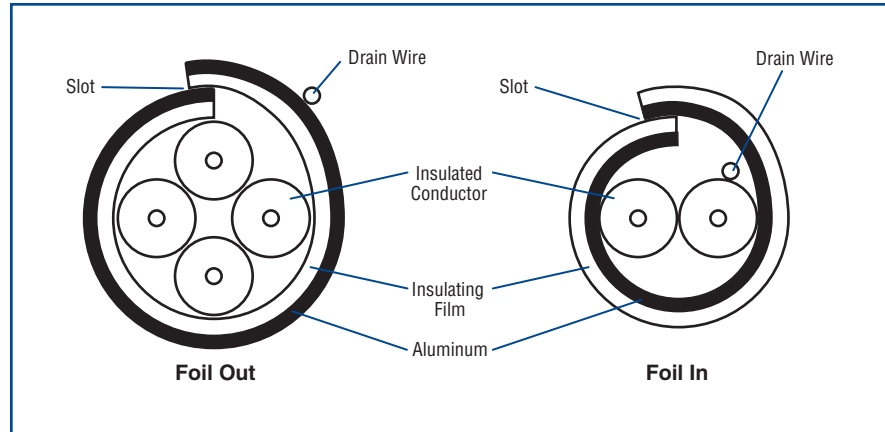

Figure 1: Foil shield configurations without shorting folds.

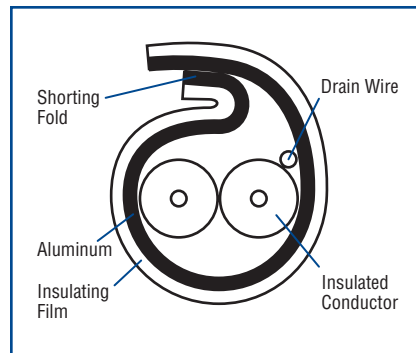

Figure 2: Foil shield configuration with shorting fold.

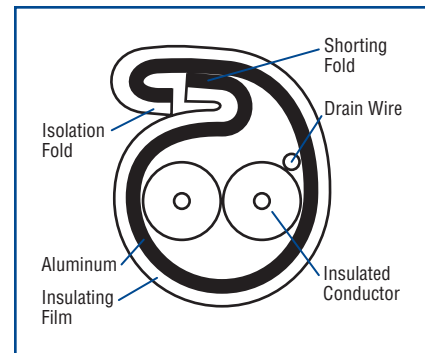

Figure 3: Foil shield with Z-Fold reduces crosstalk in multi-pair applications.

- **Shorting Fold** — Belden uses a shorting fold technique to maintain metal-to-metal contact for improved high frequency performance. Without the shorting fold, a slot is created through which signals can leak and cause interference. (See Figures 1 and 2 above.)

- **Z-Fold®** — Belden improves on the traditional shorting fold by employing a Z-Fold designed for use in multi-pair applications to reduce crosstalk. The Z-Fold (see Figure 3) combines an isolation and a shorting fold. The shorting fold provides metal-to-metal contact while the isolation fold keeps shields from shorting to one another in multi-pair, individually shielded cables.

The use of either a shorting fold or a Z-Fold increases the foil shield's range of effectiveness to higher frequencies.

Shielding and Armoring

Characteristics of Belden® Shield Types and Armor Styles

Foil Shields

Foil shields consist of aluminum foil laminated to a polyester or polypropylene film. The film gives the shield mechanical strength and bonus insulation. Foil shields provide 100% cable coverage, necessary for electrostatic shield protection. Because of their small size, foil shields are commonly used to shield individual pairs of multi-pair data cables to reduce crosstalk. They have less weight, bulk and cost less than spiral or braid shields and are generally more effective than braid shields in RF ranges. Foil shields are more flexible than braid but have a shorter flex life than spiral or braid.

Drain wires are used with foil shields to make termination easier and to ground electrostatic discharges. The shortcomings in using the foil shield include higher DC resistance and lower mechanical strength than braid or spiral shields.



Braid Shields

A braid shield consists of groups of tinned or bare copper or aluminum strands, one set woven in a clockwise direction and interwoven with another set in a counter-clockwise direction.

Braid shields provide superior structural integrity, while maintaining good flexibility and flex life. These shields are ideal for minimizing low frequency interference and have lower DC resistance than foil. Braid shields are effective at audio, as well as RF ranges. Generally, the higher the braid coverage, the more effective the shield. However, the trade-off between cost and braid coverage must be considered. Typical braid coverages are between 80% and 95%. Coverage of 100% is unattainable with a braid shield. Other features to consider when choosing a braid shield are the weave angle, strand diameter, number of carriers (strand groups) and the number of ends (strands).

Braid shields are generally bulkier and heavier than other shields and, in some cases, harder to terminate because the braid may be combed out and pigtailed.

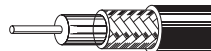

Spiral/Serve Shields

A spiral/serve shield consists of wire (usually copper) wrapped in a spiral around the inner cable core.

Superior flexibility and flex life, ease of termination and up to 97% coverage are the advantages of spiral shields. They are best suited for audio applications. As a rule, spiral shields are not effective above the audio frequency range due to the coil effect produced by the inductance of served wire strands.



“French Braid” Shields

Belden’s patented “French Braid” shield is a double spiral (double serve shield) with the two spirals tied together by one weave. This construction provides improved flex life over standard spiral shields, improved flexibility over conventional braid shields, and lower levels of microphonic or triboelectric noise than either spiral or conventional braid shields.



Combination Shields

Combination shields consist of more than one layer of shielding. They provide maximum shield efficiency across the frequency spectrum. The combination foil/braid shield combines the advantages of 100% foil coverage, plus the strength and low DC resistance of the braid.

Belden has also developed a number of shielding configurations for use with broadband coaxial cables.

- **Duobond®**
Duobond is essentially the same construction as Duofoil® (a laminated tape of foil/film/foil), but with an extra layer of adhesive bonding the foil shield to the dielectric core. This foil shield provides 100% coverage and insures maximum shield protection.

- **Duobond II (Foil/Braid)**

Combines Duobond with an outer braid, applied for greater protection against interference and to increase the overall tensile strength.



- **Duobond III (Tri-Shield)**

Utilizes the Duobond II design (foil/braid) plus a surrounding layer of Duofoil. The extra foil layer improves shield reliability and provides an additional interference barrier.



- **Duobond Plus®** — Features foil/braid/foil construction with a shorting fold in the outermost foil. This fold prevents a slot opening from being created in the shield, thereby preventing signal egress or ingress.

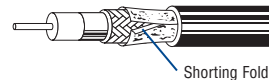

- **Duobond IV (Quad Shield)**

Offers an extra layer of braid shield (foil/braid/foil/braid) for improved strength and durability.



Other combination shields are available such as the foil/braid/foil/braid used on the Ethernet cables, braid/braid or foil/spiral.

Armoring

Belden’s innovative technology delivers maximum effectiveness to meet the performance requirements of a wide range of applications.

Belden also has the capability to protect electronic, instrumentation, and control cables with interlocking steel or aluminum armor.

Shielding and Armoring

Shield Types Application Guide, Table 8: Relative Cost Comparison of Shield Types

Table 9: Shield Performance Ratings

Shield Types Application Guide

Choose a Foil Shield...

- For protection against capacitive (electric field) coupling where shield coverage is more important than low DC resistance.
- When possible sources of interference include TV signals, crosstalk from other circuits, radio transmitters, fluorescent lights or computing equipment.
- For MATV, CATV, video, networking, computer I/O cables in office, industrial or commercial environments where ambient EMI levels are low.

Choose a Braid Shield...

- For superior performance against diffusion coupling, where low DC resistance is important, and to a lesser extent, capacitive and inductive coupling.
- When possible sources of interference exhibit low impedance characteristics, such as motor control circuits and switches which operate inductive loads.
- For computer to terminal interconnect for process, instrumentation or control applications.

Choose a Spiral Shield...

- For functional shielding against diffusion and capacitive coupling at audio frequencies only.
- When possible sources of interference are power lines and fluorescent lights.
- For applications when flexibility and flex life are major concerns, such as microphone and audio cables and retractile cords.

Choose a Combination Shield...

- For shielding against high frequency radiated emissions coupling and ESD. Combines the low resistance of braid and 100% coverage of foil shields.
- When possible sources of interference include radio transmitters, TV stations, printed circuit boards, back planes, motor control circuits and computing equipment.
- For Video, CATV, MATV, networking, computer I/O cables and computer-aided manufacturing applications.

Table 8: Relative Cost Comparison

Relative cost comparisons are based on coaxial cable. Chart shows relative shield cost as one component of the total cost of the cable. *These cost ratings may change depending on the physical construction of the cable.*

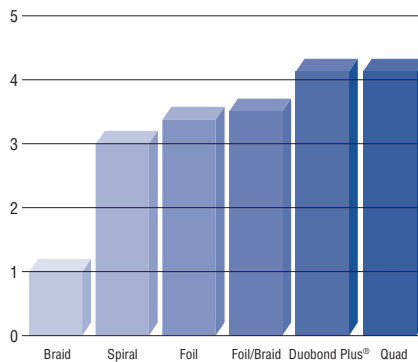

Table 9: Shield Performance Comparison Chart

Frequency Range and Types of Interference Anticipated	Cable Shield Ratings*				
	Braid (95% Coverage)	Spiral	Foil	Foil/Braid	Foil/Braid/Foil Duobond Plus®
Frequency: DC					
Capacitive	A	AA	AAA	AAA	AAA
Diffusion	AAA	A	C	AAA	AAA
Diffusion/Inductive	—	—	—	—	—
Diffusion/Inductive/Capacitive	—	—	—	—	—
Frequency: 15 kHz					
Capacitive	A	AA	AAA	AAA	AAA
Diffusion	AAA	B	C	AAA	AAA
Diffusion/Inductive	AA	C	A	AA	AAA
Diffusion/Inductive/Capacitive	—	—	—	—	—
Frequency: 10 MHz to 1000 MHz					
Capacitive	A	AA	AAA	AAA	AAA
Diffusion	—	—	—	—	—
Diffusion/Inductive	B	C	A	AA	AAA
Diffusion/Inductive/Capacitive	B	C	A	AA	AAA

*Although ratings shown in Table 9 are based on shielded coaxial cable test results, these ratings also pertain to shielded multi-conductor and flat cable where shield types are available.

Note: Shield effectiveness decreases as frequency increases. Therefore, ratings in one frequency category do not imply equal shield effectiveness in other frequency categories.

Shield Rating Key	
AAA	Best
AA	Better
A	Good
B	Functional
C	Unsatisfactory
—	Not Applicable

Metric Conversions

Table 10: Temperature Conversion Chart and Formula

Table 11: Distance and Weight Conversion Formulas

Table 10: Temperature Conversion Chart

°C ↔ °F	°C ↔ °F	°C ↔ °F	Temp. Conversion Formulas			
210	410	125	257	40	104	$^{\circ}\text{C} = \frac{5}{9} (^{\circ}\text{F} - 32)$
205	401	120	248	35	95	
200	392	115	239	30	86	$^{\circ}\text{F} = \frac{9}{5} ^{\circ}\text{C} + 32$
195	383	110	230	25	77	
190	374	105	221	20	68	
185	365	100	212	15	59	
180	356	95	203	10	50	
175	347	90	194	5	41	
170	338	85	185	0	32	
165	329	80	176	-5	23	
160	320	75	167	-10	14	
155	311	70	158	-15	5	
150	302	65	149	-20	-4	
145	293	60	140	-25	-13	
140	284	55	131	-30	-22	
135	275	50	122	-35	-31	
130	266	45	113	-40	-40	

Table 11: Distance and Weight Conversion Formulas

To Convert:	Multiply by:
Inches to millimeters	25.4
Millimeters to inches	.03937
Meters to feet	3.2808
Feet to meters	.3048
Kilometers to feet	3280.8
Feet to kilometers	.0003048
Kilograms to pounds	2.205
Pounds to kilograms	.4536
Pounds/1000 feet to pounds/1000 meters	3.2808
Pounds/1000 feet to kilograms/1000 meters	1.4882
Kilograms/1000 meters to pounds/1000 feet	.6719

Metric Conversions

Table 12: Conductor Size Equivalents (mm²/inch²/circular mils /AWG)

Sq. mm	Sq. in.	Cir. mils.	AWG	Sq. mm	Sq. in.	Cir. mils.	AWG	Sq. mm	Sq. in.	Cir. mils.	AWG
1000	1.550	1974000		55	.0853	108570		5.00	.00775	9870	
975	1.511	1924700		—	—	105600	1/0	4.75	.00736	9377	
950	1.472	1875300		50	.0775	98700		4.50	.00698	8883	
925	1.434	1826000		45	.0698	88830		4.25	.00659	8390	
900	1.395	1776600		—	—	83690	1	—	—	8230	11
875	1.356	1727300		40	.0620	78960		4.00	.00620	7896	
850	1.317	1677900		35	.0542	69090		3.75	.00581	7403	
825	1.279	1628600		—	—	66360	2	3.50	.00542	6909	
800	1.240	1579200		30	.0465	59220		—	—	6530	12
775	1.201	1529900		—	—	52620	3	3.25	.00504	6416	
750	1.163	1480500		25	.0388	49350		3.00	.00465	5922	
725	1.124	1431200		—	—	41740	4	2.75	.00426	5429	
700	1.085	1381800		20.0	.0310	39480		—	—	5180	13
675	1.046	1332500		19.5	.0302	38490		2.50	.00388	4935	
650	1.008	1283100		19.0	.0294	37510		2.25	.00349	4422	
625	.969	1233800		18.5	.0287	36520		—	—	4110	14
600	.930	1184400		18.0	.0279	35530		2.00	.00310	3948	
575	.891	1135100		17.5	.0271	34550		1.75	.00271	3455	
550	.853	1085700		17.0	.0264	33560		—	—	3260	15
525	.814	1036400		—	—	33090	5	1.50	.00233	2961	
500	.775	987000		16.5	.0256	32560		—	—	2580	16
475	.736	937700		16.0	.0248	31580		1.25	.00194	2468	
450	.698	888300		15.5	.0240	30600		—	—	2050	17
425	.659	839000		15.0	.0233	29610		1.00	.00155	1974	
400	.620	789600		14.5	.0225	28620		.90	.00140	1777	
375	.581	740300		14.0	.0217	27640		—	—	1620	18
350	.542	690900		13.5	.0209	26650		.80	.00124	1579	
325	.504	641600		—	—	26420	6	.75	.00116	1481	
300	.465	592200		13.0	.0201	25660		.70	.00109	1382	
275	.426	542900		12.5	.0194	24680		—	—	1290	19
250	.388	493500		12.0	.0186	23690		.60	.00093	1184	
225	.349	444200		11.5	.0178	22700		—	—	1029	20
200	.310	394800		11.0	.0171	21710		.50	.000775	987	
175	.271	345500		—	—	20820	7	—	—	—	
150	.233	296100		10.5	.0163	20730		—	—	—	
125	.1938	246800		10.0	.0155	19740		—	—	—	
—	—	211600	4/0	9.5	.01472	18753		—	—	—	
100	.1550	197400		9.0	.01395	17766		—	—	—	
95	.1472	187530		8.5	.01317	16779		—	—	—	
90	.1395	177660		—	—	16510	8	—	—	—	
—	—	167800	3/0	8.0	.01240	15792		—	—	—	
85	.1317	167790		7.5	.01163	14805		—	—	—	
80	.1240	157920		7.0	.01085	13818		—	—	—	
75	.1163	148050		—	—	13090	9	—	—	—	
70	.1085	138180		6.5	.01008	12831		—	—	—	
—	—	133100	2/0	6.0	.00930	11844		—	—	—	
65	.1008	128310		5.5	.00853	10857		—	—	—	
60	.0930	118440		—	—	10380	10	—	—	—	

Belden® Color Code Charts

Color Code Chart No. 1

Cond. No.	Color
1	Black
2	White
3	Red
4	Green
5	Brown
6	Blue
7	Orange
8	Yellow
9	Purple
10	Gray
11	Pink
12	Tan

18 Gage conductors in cables 8446 through 8449 are Black and White.

Color Code Chart Nos. 2 and 2R — ICEA (Insulated Cable Engineers Association) Standard*

Cond. No.	Color
1	Black
2	White
3	Red
4	Green
5	Orange
6	Blue
7	White/Black Stripe
8	Red/Black Stripe
9	Green/Black Stripe
10	Orange/Black Stripe
11	Blue/Black Stripe
12	Black/White Stripe
13	Red/White Stripe

Cond. No.	Color
14	Green/White Stripe
15	Blue/White Stripe
16	Black/Red Stripe
17	White/Red Stripe
18	Orange/Red Stripe
19	Blue/Red Stripe
20	Red/Green Stripe
21	Orange/Green Stripe
22	Black/White/Red
23	White/Black/Red
24	Red/Black/White
25	Green/Black/White
26	Orange/Black/White

Cond. No.	Color
27	Blue/Black/White
28	Black/Red/Green
29	White/Red/Green
30	Red/Black/Green
31	Green/Black/Orange
32	Orange/Black/Green
33	Blue/White/Orange
34	Black/White/Orange
35	White/Red/Orange
36	Orange/White/Blue
37	White/Red/Blue
38	Black/White/Green
39	White/Black/Green

Cond. No.	Color
40	Red/White/Green
41	Green/White/Blue
42	Orange/Red/Green
43	Blue/Red/Green
44	Black/White/Blue
45	White/Black/Blue
46	Red/White/Blue
47	Green/Orange/Red
48	Orange/Red/Blue
49	Blue/Orange/Red
50	Black/Orange/Red

* 2 = Spiral Stripe
2R = Ring Band Striping

Color Code Chart No. 3 for Paired Cables (Belden Standard)

Pair No.	Color Combination
1	Black & Red
2	Black & White
3	Black & Green
4	Black & Blue
5	Black & Yellow
6	Black & Brown
7	Black & Orange
8	Red & White
9	Red & Green
10	Red & Blue

Pair No.	Color Combination
11	Red & Yellow
12	Red & Brown
13	Red & Orange
14	Green & White
15	Green & Blue
16	Green & Yellow
17	Green & Brown
18	Green & Orange
19	White & Blue
20	White & Yellow

Pair No.	Color Combination
21	White & Brown
22	White & Orange
23	Blue & Yellow
24	Blue & Brown
25	Blue & Orange
26	Brown & Yellow
27	Brown & Orange
28	Orange & Yellow
29	Purple & Orange
30	Purple & Red

Pair No.	Color Combination
31	Purple & White
32	Purple & Green
33	Purple & Blue
34	Purple & Yellow
35	Purple & Brown
36	Purple & Black
37	Gray & White

Color Code Chart No. 4 for Paired Cables

Pair No.	Color Combination
1	White & Blue
2	White & Orange
3	White & Green
4	White & Brown
5	White & Gray

Pair No.	Color Combination
6	Red & Blue
7	Red & Orange
8	Red & Green
9	Red & Brown
10	Red & Gray

Pair No.	Color Combination
11	Black & Blue
12	Black & Orange
13	Black & Green
14	Black & Brown
15	Black & Gray

Pair No.	Color Combination
16	Yellow & Blue
17	Yellow & Orange
18	Yellow & Green
19	Yellow & Brown
20	Yellow & Gray

Pair No.	Color Combination
21	Purple & Blue
22	Purple & Orange
23	Purple & Green
24	Purple & Brown
25	Purple & Gray

Color Code Chart No. 5 for Paired Cables (Western Electric Standard)

Pair No.	Color Combination
1	White/Blue Stripe & Blue/White Stripe
2	White/Orange Stripe & Orange/White Stripe
3	White/Green Stripe & Green/White Stripe
4	White/Brown Stripe & Brown/White Stripe
5	White/Gray Stripe & Gray/White Stripe

Pair No.	Color Combination
6	Red/Blue Stripe & Blue/Red Stripe
7	Red/Orange Stripe & Orange/Red Stripe
8	Red/Green Stripe & Green/Red Stripe
9	Red/Brown Stripe & Brown/Red Stripe
10	Red/Gray Stripe & Gray/Red Stripe

Pair No.	Color Combination
11	Black/Blue Stripe & Blue/Black Stripe
12	Black/Orange Stripe & Orange/Black Stripe
13	Black/Green Stripe & Green/Black Stripe
14	Black/Brown Stripe & Brown/Black Stripe
15	Black/Gray Stripe & Gray/Black Stripe

Pair No.	Color Combination
16	Yellow/Blue Stripe & Blue/Yellow Stripe
17	Yellow/Orange Stripe & Orange/Yellow Stripe
18	Yellow/Green Stripe & Green/Yellow Stripe
19	Yellow/Brown Stripe & Brown/Yellow Stripe
20	Yellow/Gray Stripe & Gray/Yellow Stripe

Pair No.	Color Combination
21	Purple/Blue Stripe & Blue/Purple Stripe
22	Purple/Orange Stripe & Orange/Purple Stripe
23	Purple/Green Stripe & Green/Purple Stripe
24	Purple/Brown Stripe & Brown/Purple Stripe
25	Purple/Gray Stripe & Gray/Purple Stripe

Belden® Color Code Charts

Color Code Chart No. 6

Position No.	Color	Position No.	Color
1	Brown	13	White/Orange
2	Red	14	White/Yellow
3	Orange	15	White/Green
4	Yellow	16	White/Blue
5	Green	17	White/Purple
6	Blue	18	White/Gray
7	Purple	19	White/Black/Brown
8	Gray	20	White/Black/Red
9	White	21	White/Black/Orange
10	White/Black	22	White/Black/Yellow
11	White/Brown	23	White/Brown/Green
12	White/Red	24	White/Black/Blue

Chart No. 9: IBM RISC System/6000

Cond. No.	Color	Pair No.	Color Combination
1	White over Blue	1	White over Blue & Blue over White
2	White over Orange	2	White over Orange & Orange over White
3	White over Green	3	White over Green & Green over White
4	White over Brown		
5	White over Gray		
6	White over Red		
7	White over Yellow		

Chart No. 10: Fiber Optics*

Fiber/Tube No.	Color
1	Blue
2	Orange
3	Green
4	Brown
5	Gray
6	White
7	Red
8	Black
9	Yellow
10	Purple
11	Rose
12	Aqua

*Per TIA/EIA 598-A

Color Code Chart No. 7 for Snake Cables

Pair No.	Color Combination	Pair No.	Color Combination	Pair No.	Color Combination	Pair No.	Color Combination
1	Brown	16	Gray/Yellow Stripe	31	Blue/Purple Stripe	46	Lime/Black Stripe
2	Red	17	Gray/Green Stripe	32	Blue/Gray Stripe	47	Lime/Tan Stripe
3	Orange	18	Gray/Blue Stripe	33	Blue/White Stripe	48	Lime/Pink Stripe
4	Yellow	19	Gray/Purple Stripe	34	Blue/Black Stripe	49	Aqua/Brown Stripe
5	Green	20	Gray/Gray Stripe	35	Blue/Tan Stripe	50	Aqua/Red Stripe
6	Blue	21	Gray/White Stripe	36	Blue/Pink Stripe	51	Aqua/Orange Stripe
7	Purple	22	Gray/Black Stripe	37	Lime/Brown Stripe	52	Aqua/Yellow Stripe
8	Gray	23	Gray/Tan Stripe	38	Lime/Red Stripe	53	Aqua/Green Stripe
9	White	24	Gray/Pink Stripe	39	Lime/Orange Stripe	54	Aqua/Blue Stripe
10	Black	25	Blue/Brown Stripe	40	Lime/Yellow Stripe	55	Aqua/Purple Stripe
11	Tan	26	Blue/Red Stripe	41	Lime/Green Stripe	56	Aqua/Gray Stripe
12	Pink	27	Blue/Orange Stripe	42	Lime/Blue Stripe	57	Aqua/White Stripe
13	Gray/Brown Stripe	28	Blue/Yellow Stripe	43	Lime/Purple Stripe	58	Aqua/Black Stripe
14	Gray/Red Stripe	29	Blue/Green Stripe	44	Lime/Gray Stripe	59	Aqua/Tan Stripe
15	Gray/Orange Stripe	30	Blue/Blue Stripe	45	Lime/White Stripe	60	Aqua/Pink Stripe

Color Code Chart No. 8 for DataTwist® Cables (Modified Western Electric)

Pair No.	Color Combination	Pair No.	Color Combination	Pair No.	Color Combination	Pair No.	Color Combination	Pair No.	Color Combination
1	White/Blue Stripe & Blue	6	Red/Blue Stripe & Blue/Red Stripe	11	Black/Blue Stripe & Blue/Black Stripe	16	Yellow/Blue Stripe & Blue/Yellow Stripe	21	Purple/Blue Stripe & Blue/Purple Stripe
2	White/Orange Stripe & Orange	7	Red/Orange Stripe & Orange/Red Stripe	12	Black/Orange Stripe & Orange/Black Stripe	17	Yellow/Orange Stripe & Orange/Yellow Stripe	22	Purple/Orange Stripe & Orange/Purple Stripe
3	White/Green Stripe & Green	8	Red/Green Stripe & Green/Red Stripe	13	Black/Green Stripe & Green/Black Stripe	18	Yellow/Green Stripe & Green/Yellow Stripe	23	Purple/Green Stripe & Green/Purple Stripe
4	White/Brown Stripe & Brown	9	Red/Brown Stripe & Brown/Red Stripe	14	Black/Brown Stripe & Brown/Black Stripe	19	Yellow/Brown Stripe & Brown/Yellow Stripe	24	Purple/Brown Stripe & Brown/Purple Stripe
5	White/Gray Stripe & Gray/White Stripe	10	Red/Gray Stripe & Gray/Red Stripe	15	Black/Gray Stripe & Gray/Black Stripe	20	Yellow/Gray Stripe & Gray/Yellow Stripe	25	Purple/Gray Stripe & Gray/Purple Stripe



Belden® Color Code Charts

ICEA Table E1*

Cond. No.	Base Color	Tracer	Tracer	Cond. No.	Base Color	Tracer	Tracer
1	Black	—	—	26	Orange	Black	White
2	White	—	—	27	Blue	Black	White
3	Red	—	—	28	Black	Red	Green
4	Green	—	—	29	White	Red	Green
5	Orange	—	—	30	Red	Black	Green
6	Blue	—	—	31	Green	Black	Orange
7	White	Black	—	32	Orange	Black	Green
8	Red	Black	—	33	Blue	White	Orange
9	Green	Black	—	34	Black	White	Orange
10	Orange	Black	—	35	White	Red	Orange
11	Blue	Black	—	36	Orange	White	Blue
12	Black	White	—	37	White	Red	Blue
13	Red	White	—	38	Black	White	Green
14	Green	White	—	39	White	Black	Green
15	Blue	White	—	40	Red	White	Green
16	Black	Red	—	41	Green	White	Blue
17	White	Red	—	42	Orange	Red	Green
18	Orange	Red	—	43	Blue	Red	Green
19	Blue	Red	—	44	Black	White	Blue
20	Red	Green	—	45	White	Black	Blue
21	Orange	Green	—	46	Red	White	Blue
22	Black	White	Red	47	Green	Orange	Red
23	White	Black	Red	48	Orange	Red	Blue
24	Red	Black	White	49	Blue	Red	Orange
25	Green	Black	White	50	Black	Orange	Red

Pair cables are Black, White and numbered. Triad cables are Black, White, Red and numbered.

ICEA Table E2*

Cond. No.	Base Color	Tracer	Cond. No.	Base Color	Tracer
1	Black	—	19	Orange	Blue
2	Red	—	20	Yellow	Blue
3	Blue	—	21	Brown	Blue
4	Orange	—	22	Black	Orange
5	Yellow	—	23	Red	Orange
6	Brown	—	24	Blue	Orange
7	Red	Black	25	Yellow	Orange
8	Blue	Black	26	Brown	Orange
9	Orange	Black	27	Black	Yellow
10	Yellow	Black	28	Red	Yellow
11	Brown	Black	29	Blue	Yellow
12	Black	Red	30	Orange	Yellow
13	Blue	Red	31	Brown	Yellow
14	Orange	Red	32	Black	Brown
15	Yellow	Red	33	Red	Brown
16	Brown	Red	34	Blue	Brown
17	Black	Blue	35	Orange	Brown
18	Red	Blue	36	Yellow	Brown

Pair cables are Black, Red and numbered. Triad cables are Black, Red, Blue and numbered. Colors repeat after 36 conductors. There are no Green or White conductors or stripes.

*Reference ICEA S-73-532

ICEA Method 4: All conductors Black*

Cond.	Conductor Printing	Cond.	Conductor Printing
1 st	"1-ONE-1"	26 th	"26-TWENTY-SIX-26"
2 nd	"2-TWO-2"	27 th	"27-TWENTY-SEVEN-27"
3 rd	"3-THREE-3"	28 th	"28-TWENTY-EIGHT-28"
4 th	"4-FOUR-4"	29 th	"29-TWENTY-NINE-29"
5 th	"5-FIVE-5"	30 th	"30-THIRTY-30"
6 th	"6-SIX-6"	31 st	"31-THIRTY-ONE-31"
7 th	"7-SEVEN-7"	32 nd	"32-THIRTY-TWO-32"
8 th	"8-EIGHT-8"	33 rd	"33-THIRTY-THREE-33"
9 th	"9-NINE-9"	34 th	"34-THIRTY-FOUR-34"
10 th	"10-TEN-10"	35 th	"35-THIRTY-FIVE-35"
11 th	"11-ELEVEN-11"	36 th	"36-THIRTY-SIX-36"
12 th	"12-TWELVE-12"	37 th	"37-THIRTY-SEVEN-37"
13 th	"13-THIRTEEN-13"	38 th	"38-THIRTY-EIGHT-38"
14 th	"14-FOURTEEN-14"	39 th	"39-THIRTY-NINE-39"
15 th	"15-FIFTEEN-15"	40 th	"40-FORTY-40"
16 th	"16-SIXTEEN-16"	41 st	"41-FORTY-ONE-41"
17 th	"17-SEVENTEEN-17"	42 nd	"42-FORTY-TWO-42"
18 th	"18-EIGHTEEN-18"	43 rd	"43-FORTY-THREE-43"
19 th	"19-NINETEEN-19"	44 th	"44-FORTY-FOUR-44"
20 th	"20-TWENTY-20"	45 th	"45-FORTY-FIVE-45"
21 st	"21-TWENTY-ONE-21"	46 th	"46-FORTY-SIX-46"
22 nd	"22-TWENTY-TWO-22"	47 th	"47-FORTY-SEVEN-47"
23 rd	"23-TWENTY-THREE-23"	48 th	"48-FORTY-EIGHT-48"
24 th	"24-TWENTY-FOUR-24"	49 th	"49-FORTY-NINE-49"
25 th	"25-TWENTY-FIVE-25"	50 th	"50-FIFTY-50"

Cable Standards Reference Guide

National Electrical Code (NEC)[®] Catalog Reference Information

The National Electrical Code is a set of guidelines describing procedures which minimize the hazards of electrical shock, fires, and explosions caused by electrical installation. The text of the NEC is contained in nine chapters, each chapter broken into individual articles.

NEC types are acronyms consisting of a prefix describing cable type (e.g. coax, CATV, fiber optic) and a suffix indicating the type of flame test it has passed and where it can be installed. Articles describing wire and cable products — including required cable markings — are listed in the chart to the right.

Impact of the NEC

Almost everyone involved with wire and cable is affected by the National Electrical Code. In particular, the following groups must incorporate NEC guidelines into their work: OEM engineers, wire and cable product engineers, distributors, installers, and architects.

Although NEC covers wire and cable installed in factories, office buildings, hotels, motels, apartment buildings, residences, and all cables which pass through any floor, wall, ceiling, or which travel in ducts, plenums, and other air handling spaces, each individual municipality, city, county, or state can decide whether or not they wish to adopt the 2002 NEC as law. Local authorities having jurisdiction enforce their own codes. They have the right to accept or refuse any installation in accordance with their own local laws. One of the organizations local inspectors rely on to test wire and cable is Underwriters Laboratories (UL).

Intended Uses of Appliance Wiring Materials (AWM)

In the past, AWM cable was incorrectly used to wire buildings—this was never its intended use.

AWM cable is intended for internal wiring of factory-assembled, listed appliances such as computers, business machines, ranges, washers, dryers, radios, and televisions.

In some cases, AWM cable may be used for external connection. In these situations, the user should be aware that AWM cable temperatures and voltage ratings may differ from NEC ratings.

NEC Article/Type	Description	Installation Type				
		Plenum	Riser	Commercial	Residential	
725	CL2	Class 2 cables	CL2P	CL2R	CL2	CL2X*
	CL3	Class 3 cables	CL3P	CL3R	CL3	CL3X*
	PLTC	A stand-alone class. This is a power limited tray cable — a CL3-type cable which can be used outdoors, is sunlight- and moisture-resistant and must pass the Vertical Tray flame test.	(none)	(none)	PLTC	(none)
760	FPL	Power limited, fire protective signaling circuit cable	FPLP	FPLR	FPL	(none)
770	OFC	Fiber cable also containing metallic conductors	OFCP	OFCR	OFCG, OFC	(none)
	OFN	Fiber cable only containing optical fibers	OFNP	OFNR	OFNG, OFN	(none)
800	CM	Communications	CMP	CMR	CMG, CM	CMX*
	MP	Multi-Purpose Cables	MPP	MPR	MPG, MP	(none)
820	CATV	Community antenna television and radio distribution system	CATVP	CATVR	CATV	CATVX**
830	BM	Network-powered broadband communications cable	BLP	BMR	BM	BLX

*Cable diameter must be less than 0.250" **Cable diameter must be less than 0.375"

C(UL) Certifications

UL/NEC-Approved cables may also be C(UL)/CEC-Approved as communications cables meeting the requirements of the Bi-National Standard CSA C22.2 No. 214/UL 444 and Section 60 of the Canadian Electrical Code, Part I (CEC). The C(UL) cable designation (and its meaning) would be one of the following:

1. **CMP** — Cable meeting CSA FT7 or NFPA 262 (UL 910);
2. **CMR** — Cable meeting UL 1666;
3. **CMG** — Cable meeting CSA FT4;
4. **CM** — Cable meeting UL 1685 (UL 1581, Sec. 1160) Vertical-Tray;
5. **CMX** — meeting UL 1581, Sec. 1080 (VW-1);
6. **CMH** — Cable meeting CSA FT1.

NOTE: The CSA flame tests are defined in CSA C22.2 No. 0.3 as follows:

FT1 Vertical Flame Test — per C.S.A. C22.2 No. 0.3-92 Para 4.11.1

A finished cable shall not propagate a flame or continue to burn for more than one (1) minute after five (5) fifteen (15) second applications of the test flame. There is an interval of fifteen (15) seconds between flame applications. The flame test shall be performed in accordance with Para 4.11.1 of Canadian Standards Association (CSA) Standard C22.2 No. 0.3. In addition, if more than 25% of the indicator flag is burned, the test cable fails.

FT4 Vertical Flame Test — Cables in Cable Trays per C.S.A. C22.2 No. 0.3-92 Para 4.11.4

The FT4 Vertical Flame Test — Cables in Cable Trays is similar to the UL-1685 Vertical Tray Flame Test, but is more severe. The FT4 test has its burner mounted at 20° from the horizontal with the burner ports facing up. The UL-1685 Vertical Tray has its burner at 0° from the horizontal. The FT4 samples must be larger than 13mm (.512") in diameter.

If not, then the cable samples are grouped in units of at least three (3) to obtain a grouped overall diameter of 13mm. The UL-1581 Vertical Tray does not distinguish on cable size. The FT4 has a maximum char height of 1.5 m (59") measured from the lower edge of the burner face. The UL-1685 has a flame height allowable up to approximately 78" measured from the burner.

FT6 Horizontal Flame & Smoke Test — per C.S.A. C22.2 No. 0.3-92 Appendix B

Belden[®] products passing the FT6 Horizontal Flame and Smoke Test are designated FT6 in the column where the trade number appears. This test is for cables which must pass a Horizontal Flame and Smoke Test in accordance with ANSI/NFPA Standard 262-1985 (UL-910). The maximum flame spread shall be 1.50 meters (4.92 ft.). The smoke density shall be 0.5 at peak optical density and 0.15 at maximum average optical density.

National Electrical Code and NEC are registered trademarks of the National Fire Protection Association, Inc., Quincy, MA.



For more information, contact [Belden Technical Support: 1-800-BELDEN-1 • www.belden.com](mailto:Technical.Support@belden.com)

Cable Substitution Chart

Per 2005 NEC®

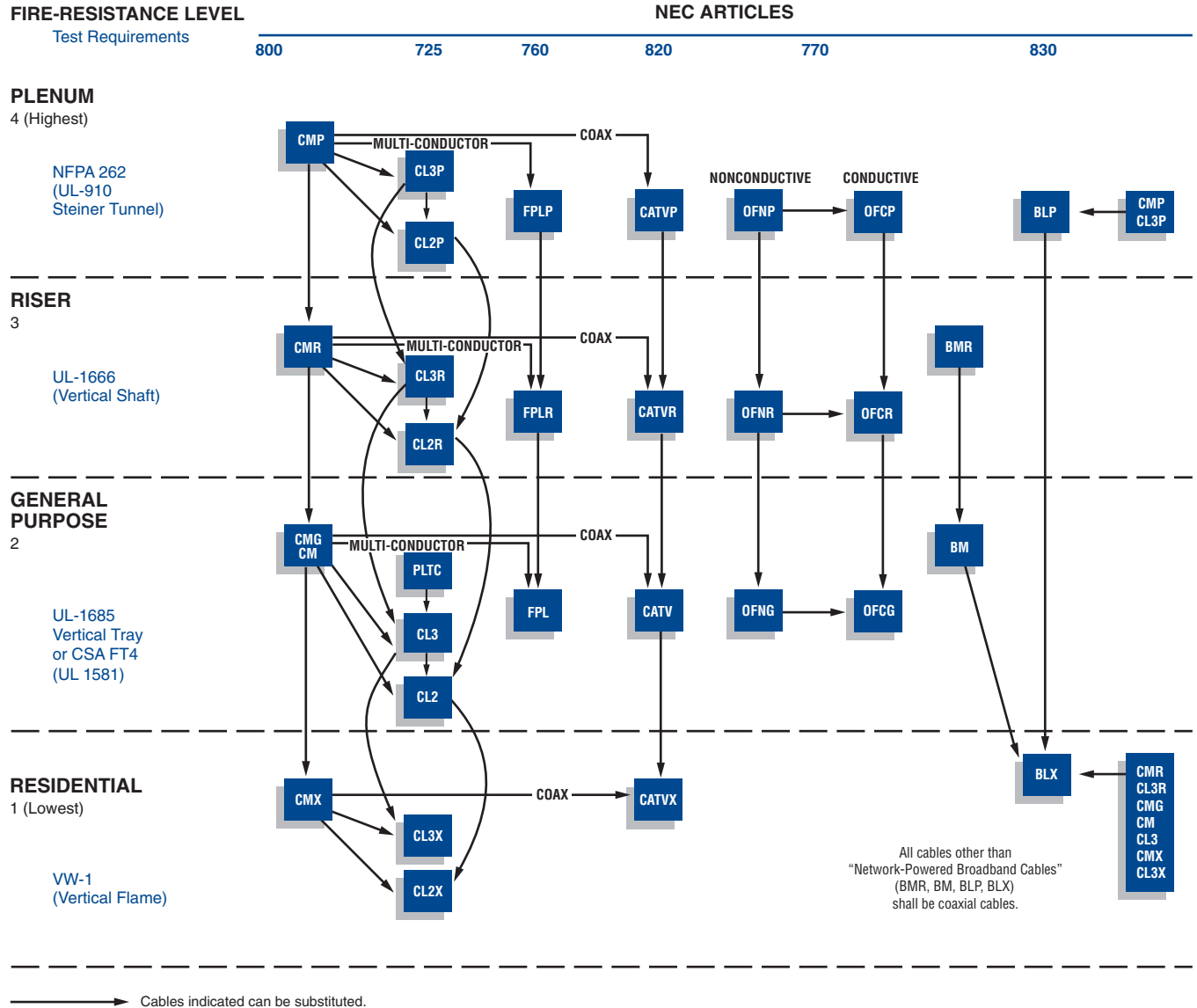

NEC Type	Definition
CMP, CMR, CMG, CM, CMX	Communications Cables
CL3P, CL3R, CL3, CL3X, CL2P, CL2R, CL2, CL2X	Class 2 and Class 3 Remote-Control, Signaling and Power Limited Cables
FPLP, FPLR, FPL	Power Limited Fire Alarm Cables
CATVP, CATVR, CATV, CATVX	Community Antenna Television and Radio Distribution Cables
OFNP, OFNR, OFNG, OFN	Nonconductive Optical Fiber Cables
OFCP, OFCR, OFCG, OFC	Conductive Optical Fiber Cables
PLTC	Power Limited Tray Cables
BMR, BM, BLP, BLX	Network-powered Broadband Communications Cable

National Electrical Code and NEC are registered trademarks of the National Fire Protection Association, Inc., Quincy, MA.

Canadian Electrical Code (CEC) Substitution Chart

Terms of Use of Master Catalog

Cable Substitution Hierarchy as per C22.2 #214 — Communication Cables

Canadian Electrical Code, Part 1, Table 19, Note 22:

The following cable substitution may be used:

- a.** Communication cables marked MPP, CMP, MPR, CMR, MPG, CMG, MP, CM, CMX, CMH, FT6, and FT4 have been found to meet the standard criteria for FT1.
- b.** Communication cables marked MPP, CMP, MPR, CMR, MPG, CMG, and FT6 have been found to meet the standard criteria for FT4.
- c.** Communication cables marked MPP and CMP have been found to meet the standard criteria for FT6.

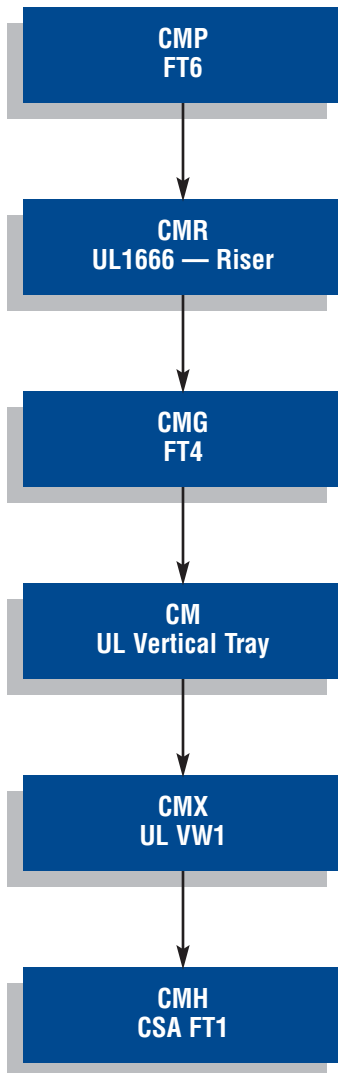

Terms of Use of Master Catalog

Use of Information; Disclaimers

Although Belden Electronics Division (“Belden”) makes every reasonable effort to ensure their accuracy at the time of this publication, information and specifications described in this catalog are subject to change without notice. The most current product information may be found by accessing our Website at www.belden.com or contacting Belden Technical Support at 1-800-BELDEN-1.

Belden provides the information and specifications in this catalog on an “AS IS” basis, with no representations or warranties, whether express, statutory or implied. WITH RESPECT TO SUCH INFORMATION AND SPECIFICATIONS, BELDEN DISCLAIMS ALL WARRANTIES OF MERCHANTABILITY, FITNESS FOR INTENDED PURPOSE AND NON-INFRINGEMENT. IT ALSO EXCLUDES ANY EXPRESS OR IMPLIED WARRANTIES ARISING FROM ANY COURSE OF DEALING, USAGE, TRADE PRACTICE OR PERFORMANCE. BELDEN’S SOLE WARRANTIES ARE AS BELDEN MAY PROVIDE IN (AND SUBJECT TO THE TERMS AND LIMITATIONS OF) SEPARATE WARRANTY DOCUMENTATION.

In no event will Belden be liable for any damages (including consequential, indirect, incidental, special, punitive, or exemplary damages) whatsoever, even if Belden has been advised of the possibility of such damages, whether in an action under contract, negligence or any other theory, arising out of or in connection with the use, inability to use, or performance of the information, specifications or products described in this catalog.

Belden’s Terms and Conditions of Sale

All sales of Belden® products are subject to Belden’s standard terms and conditions of sale.

Intellectual Property Protection

All trademarks or registered trademarks mentioned in this catalog are property of their respective owners. The information contained in this catalog is protected by copyright. No part of this catalog may be reproduced by any means without the prior written permission from Belden.

U.S. Export Laws

The United States Export Controls laws prohibit the export of certain technical data and software to certain territories. No content from this catalog may be reproduced or otherwise exported in violation of United States Law.

Environmental Regulations and Compliance

Heavy Metal Free, RoHS and Prop 65

Over the past several years, increased attention has been placed upon the potential environmental impacts of electronic products. Both voluntary and regulatory measures have been taken to address some of these concerns. Already in place are California Proposition 65 and the European Union End-of-Life Vehicle (ELV) and Flame Retardant Directives. The next major impact will be the European Union Restriction on Hazardous Substances (RoHS) Directive that will restrict the use of heavy metal substances (Lead, for example) in electronic products in July 2006. There are also several states and countries currently considering their own legislation on this topic.

The use of materials that are environmentally friendly is of growing concern to Belden, its customers and to the global community. Belden is engaged in a division-wide project to integrate into its product designs and supplier requirements a formalized program to restrict the use of these materials by January 2006. The following list of materials represents examples of substances that Belden is eliminating or reducing in certain applications:

- Asbestos and its compounds
- Cadmium and its compounds
- Chromium VI and its compounds
- Lead and its compounds
- Mercury and its compounds
- Polybrominated biphenyls (PBBs) and their ethers/oxides (PBDEs, PBBEs)
- Di-(2-ethylhexyl)phthalate (DEHP)
- Penta-, Octa- BDE Brominated flame retardants

As a result of this project, many of Belden's products are now, heavy metal free and meet the requirements of both RoHS and California Proposition 65. For a more detailed definition of the above named regulations, please consult the glossary of terms located in the back of the catalog. Contact Belden Customer Service or visit www.belden.com for more specific product details and current compliance information.

RoHS Compliance

Unless so marked, cables in this catalog do not contain any of the following restricted substances, as an intentional additive, and is therefore compliant with European Directive 2002/95/EC (RoHS), European Directive 2000/53/EC (ELV), European Directive 2003/11/EC (BFR), European Directive 2002/96/EC (WEEE), and California Proposition 65 Consent Judgement for Wire & Cable Manufacturers [San Francisco Superior Court Nos. 312962 and 320342] (Prop 65).

For customer convenience, Belden products that are in compliance with these directives contain the identification "ROHS" within the text of the jacket surface printing and also an environmentally friendly logo (as shown at right) on package labeling.

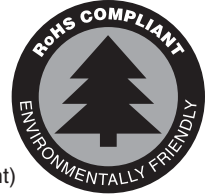

Substance	Maximum Concentration*
Lead	0.03%
Mercury	0.10%
Hexavalent Chromium	0.10%
PBB, PBDE**	0.10%
Cadmium	0.01%

*Per homogeneous material, as trace or contaminate amount.

**Some Belden cables may contain Decabromodiphenyl Oxide/Ether (PBDE) as a flame retardant. This substance is currently exempt from RoHS.

In addition, Belden products do not contain Asbestos and its compounds or Di-(2-ethylhexyl)phthalate (DEHP).

This determination is based upon information obtained from sources which Belden believes are reliable, and from random sample testing at the Belden Engineering Center; however, the information is provided without any representation of warranty, expressed or implied, regarding accuracy or correctness. Belden does not specifically run any analysis on our raw materials or end product to measure for these substances.

The information provided in this catalog, and the identification of materials listed as reportable or restricted within the catalog, is correct to the best of Belden's knowledge, information and belief at the date of its publication. The information provided in the catalog is designed only as a general guide for the safe handling, storage, and any other operation of the product itself or the one that it becomes a part of. This catalog is not to be considered a warranty or quality specification. Regulatory information is for guidance purposes only. Product users are responsible for determining the applicability of legislation and regulations based on their individual usage of the product.

Cable Packaging

Belden, a recognized leader in state-of-the-art packaging design, has introduced a variety of packaging styles and options for the convenience of our customers:

UnReel®

A wide variety of Belden® cable and plenum cable is available in Belden's UnReel cardboard dispenser.

Belden UnReel is a unique packaging/dispensing system developed to save time, cut costs and labor, and eliminate the need for dereeling equipment.

Lightweight and more economical than conventional drums or reels, UnReel dispensers have pre-punched handles for easy, individual transport as well as rectangular boxes for easy pallet delivery and storage. Unreeled cable pays out smoothly and evenly with no kinking, twisting, or backlashing. It also rolls out 60% faster per hour than conventionally packaged cable.

UnReel ships, stores and dispenses in one carton, which — since its introduction — has always been fully recyclable and biodegradable. Look for the letter “U” in the put-up (“Length”) description.

Reel-In-A-Box

Belden's Reel-In-A-Box facilitates cable payout, making installations quicker and easier. And because it's primarily corrugated fiberboard material with plastic inserts, it weighs less than wooden crate reels. That makes it easier to handle and dispose of, as well as less costly to ship.

A 5" barrel, standard on every Belden® Reel-In-A-Box, helps eliminate memory — a typical problem encountered with 3" barrels used by other manufacturers.

The new Reel-In-A-Box is extremely durable. It has passed cold drop tests to -30°C, which translates to maximum protection on the job as well as in shipping. Look for the letter “A” in the put-up description.

Glossary of Terms

5-Mil Copper — Solid Copper Shield. Provides added electrical protection.

802.14 — IEEE's Cable TV MAC and PHY Protocol Working Group.

10GBASE-T — IEEE standard for 10 Gigabit Ethernet transmission over copper.

10GX[®] — Belden's most advanced end-to-end UTP structured cabling system delivering guaranteed performance of 625 MHz and data-rates of 10Gb/s.

A — Ampere.

ABR — Available Bit Rate.

Abrasion Resistance — Ability of a wire, cable or material to resist surface wear.

Abrasion Stripper — More accurately described as "buffing stripper," which is a motorized device for removing flat cable insulation by means of one or two buffing wheels that melt the insulation and brush it away from the conductors.

AC — Alternating current. Electric current that alternates or reverses polarity in a cyclical manner (e.g. 60 Hz AC power).

Accelerated Aging — A test that simulates long time environmental conditions in a relatively short time.

ACMC — Alien Crosstalk Margin Computation is the Pass/Fail criteria to determine if a channel complies with 10GBASE-T Alien noise requirements.

ACR — Attenuation Crosstalk Ratio. The difference between attenuation and crosstalk, measured in dB, at a given frequency. Important characteristic in networking transmission to assure that signal sent down a twisted pair is stronger at the receiving end of the cable than are any interference signals imposed on that same pair by crosstalk from other pairs.

ADSL — Asymmetric Digital Subscriber Line.

AES/EBU — Informal name of a digital audio standard established jointly by the AES (Audio Engineering Society) and EBU (European Broadcast Union) organizations.

AF — Audio frequency.

AFEXT — Alien far-end crosstalk loss is a measure of the unwanted signal coupling from near-end disturbing channel pairs into a disturbed pair of a neighboring channel or part thereof, measured at the far-end.

Air Core — Cables that are not gel filled.

Air-Gap Dielectric — A coaxial design in which a monofilament of plastic holds the center conductor in place in a hollow plastic tube allowing the remainder of the dielectric to be air. Typical velocities of up to 84% can be achieved in this design.

Alien crosstalk — A measure of the unwanted signal coupling between cabling or components in close proximity.

Alloy — A combination of two or more different polymers/metals. Usually combined to make use of different properties of each polymer/metal.

Alpeth — Coated Aluminum Polyethylene. Basic sheath.

Alternating Current (AC) — Electric current that alternates or reverses polarity in a cyclical manner (e.g. 60 Hz AC power).

AM — Amplitude modulation.

Ambient — Conditions that exist in the environment of the cable. Conditions existing at a test or operating location prior to energizing equipment (e.g. ambient temperature).

American Wire Gage (AWG) — A standard for expressing wire diameter. As the AWG number gets smaller, the wire diameter gets larger.

Ampacity — Current handling capability expressed in amperes. The maximum current a conductor can carry without being heated beyond a safe limit.

Ampere — A standard unit of current. Defined as the amount of current that flows when one volt of electromotive force (EMF) is applied across one ohm of resistance. One ampere of current is produced by one coulomb of charge passing a point in one second.

Amplitude — The magnitude of a current or voltage. It can be the maximum, minimum, average or RMS value of an alternating current (AC) signal. These four magnitudes are the same for a direct current (DC) signal.

Analog — Representation of data by continuously variable quantities as opposed to a finite number of discrete quantities in digital.

Analog Signal — An electrical signal which varies continuously, not having discrete values. Analog signals are copies or representations of other waves in nature. An analog audio signal, for instance, is a representation of the pressure waves which make up audible sound.

ANEXT — Alien near-end crosstalk loss is a measure of the unwanted signal coupling from near-end disturbing channel pairs into a disturbed pair of a neighboring channel or part thereof, measured at the near-end.

Anneal — To soften and relieve strains in any solid material, such as metal or glass, by heating to just below its melting point and then slowly cooling it. Annealing generally lowers the tensile strength of the material, while improving its flex life and flexibility.

ANSI — American National Standards Institute.

ASP — Aluminum Steel Polyethylene. Provides mechanical and electrical protection.

ASTM — The American Society for Testing and Materials, a standards organization which suggests test methods, definitions and practices.

Asynchronous Transfer Mode — The SONET standard for a packet switching technique which uses packets of a fixed length.

ATM — Asynchronous Transfer Mode.

Attenuation — The decrease in magnitude of a signal as it travels through any transmitting medium, such as a cable or circuitry. Attenuation is usually expressed logarithmically as the ratio of the original and decreased signal amplitudes. It is usually expressed in decibels (dB).

Audio — A term used to describe sounds within the range of human hearing (20 Hz to 20 kHz). Also used to describe devices which are designed to operate within this range.

Audio Frequency — Frequencies within the range of human hearing (approximately 20 Hz to 20 kHz).

Augmented Category 6 — TIA standard for a cabling system and components specified to 500MHz to support 10GBASE-T and other high frequency applications.

AWG — American Wire Gage. A wire diameter specification. The smaller the AWG number, the larger the wire diameter.

AWM — Appliance Wiring Material. A UL designation for a type of wire.

Backbone — The cable used to connect all systems of a multi-level distributed system to an intermediate system.

Backshell — Housing on a connector that covers the area where the cable conductors connect to the connector contacts. It can be a metal housing providing continuity of the shield through IDC connectors.

Balanced Line — A cable having two identical conductors which carry voltages opposite in polarity, but equal in magnitude with respect to ground, suitable for differential signal transmission.

Balun — Balanced to unbalanced (Bal-un) transformer used to connect an unbalanced transmission line (i.e. coaxial cable) to a balanced system or cable, or vice versa. It can also provide impedance transformation, as 300 ohm balanced to 75 ohm unbalanced.

Bandwidth — The difference between the upper and lower limits of a given band of frequencies. It is expressed in Hertz. The range of frequencies that a transmitted communications signal occupies or that a receiving system can accept. For example, it takes more bandwidth to download a photograph in a second than to download a page of text. Virtual reality and three-dimensional audio/visual presentations require even more.

Baud — Rate of digital transmission equal to the reciprocal of the time of one output signaling element.

Bel — A unit that represents the logarithm of the ratio of two levels. One bel equals the base 10 logarithm of the ratio of two power levels. It is also equal to the base 10 logarithm of square of the ratio of two voltage or current levels, provided the impedances are the same at the two levels. (See *dB*.)

Belden — A leading manufacturer of the specialty wire, cable and fiber products needed for new applications in data, audio, video and voice signal transmission, among other things.

Belflex[®] — A premium hybrid matte-finish jacket material that exhibits superior flexibility at low temperatures along with resistance compared to standard PVC jacketing materials.

Beldfoil[®] — Belden trademark for highly effective electrostatic shield of reinforced metallic foil.

Glossary of Terms

- Beldsol™** — Solderable Belden magnet wire combining insulating films of polyurethane for excellent dielectric characteristics and nylon for mechanical protection.
- Bend Loss** — A form of increased attenuation caused by (a) having an optical fiber curved around a restrictive radius of curvature or (b) microbends caused by minute distortions in the fiber imposed by externally induced perturbations.
- Bend Radius** — Radius of curvature that a flat, round fiber optic or metallic cable can bend without any adverse effects.
- Binder** — A tape or thread used for holding assembled cable components in place.
- Bit** — One binary digit.
- Bit Error Rate** — The number of errors occurring in a system per unit of time (e.g. bits per second).
- Bits Per Second** — The number of binary bits that can be transmitted per second (bps), i.e. Mbps (Mega = million), Gbps (Giga = billion).
- BNC** — Abbreviation for "Bayonet Neil-Concelman." A coaxial cable connector used extensively in video and RF applications and named for its inventors.
- Bonded** — 1) Adhesive application of a metallic shielding tape to the dielectric of a coaxial cable to improve electrical performance and ease of connector installation. Also refers to adhesive application of a metallic shielding tape to the jacket of a cable. 2) Steel is bonded to polyethylene with a copolymer adhesive. All Stalpath and some ASP cables are bonded. Provides extra strength to jacket, primarily used in underground applications.
- Bonded ASP** — Aluminum Steel Polyethylene where the steel is bonded to polyethylene for strength. Filled cables for use in ducts.
- Bonding** — The method used to produce good electrical contact between metallic parts of any device. Used extensively in automobiles and aircraft to prevent static buildup. Also refers to the connectors and straps used to bond equipment.
- Booster** — An amplifier inserted into a cable to increase the signal amplitude in order to compensate for signal loss due to attenuation. This extends the transmission range of the cable. Transformers may be employed to boost AC voltages. The term booster is also applied to amplifiers used in television receiving antenna systems.
- BPS** — Bits per second. (See *Bits Per Second*.)
- BPSK** — Binary Phase Shift Keying. A type of digital transmission where two phases of the signal are possible to represent binary one and zero.
- Braid** — A group of textile or metallic filaments interwoven to form a tubular flexible structure which may be applied over one or more wires or flattened to form a strap.
- Braid Angle** — The angle between a strand of wire in a braid shield and the longitudinal axis (i.e. axis along the length of the center) of the cable it is wound around.
- Breakdown Voltage** — The voltage at which the insulation between two conductors will fail and allow electricity to conduct or "arc."
- Breakout** — The point at which a conductor or conductors are separated from a multi-conductor cable to complete circuits at various points along the main cable.
- BRI** — Basic Rate Interface ISDN.
- Broadband** — The technique used to multiplex multiple networks on a single cable without interfering with each other. Technologies that allow you to transmit or receive higher volumes of data at higher speeds.
- Buffer** — A protective coating over an optical fiber.
- Buffing Stripper** — A motorized device for removing flat cable insulation by means of one or two buffing wheels that melt the insulation and brush it away from the conductors. Also called Abrasion Stripper.
- Bunch Strand** — Conductors twisted together with the same lay and direction without regard to geometric pattern.
- Buried** — Cables that are required to go underground.
- Bus-bar Wire** — Uninsulated tinned copper wire used as a common lead.
- Butyl Rubber** — A synthetic rubber with good electrical insulating properties.
- Byte** — A group of eight adjacent binary digits (8 bits).
- C** — Capacitance (electrical). Celsius (temperature).
- Cable** — A group of individually insulated conductors or subcomponents twisted helically.
- Cable Modem** — A device that enables you to hook up your PC to a local cable TV line and receive data at much faster rates than telephone modems and ISDN lines. A strong competitor to DSL telephone service.
- Cabling** — The grouping or twisting together of two or more insulated conductors or subcomponents to form a cable.
- CACSP** — Coated Aluminum, Coated Steel, Polyethylene. Provides additional strength and protection.
- California Proposition 65 (Prop 65)** — Refers to the California Proposition 65 Consent Judgement for wire & cable manufacturers (San Francisco Superior Court nos. 312962 and 320342). **Compliant Products** have less than 300ppm of lead (by weight) in their outer surface layer. **Exempt Products** are those that are infrequently handled, manufactured before September 2003, distributed/sold outside the State of California, internal components not normally accessible to the consumer, or contain Prop 65 substances as part of the internal conductor or other component not normally accessible to the consumer. Contact Belden Customer Service or visit www.belden.com for product specific details.
- Canadian Electrical Code (CEC)** — Canadian version of the US National Electrical Code (NEC).
- CAP** — Carrierless Amplitude Phase Modulation.
- Capacitance** — The ability of a dielectric material between conductors to store energy when a difference of potential exists between the conductors. The unit of measurement is the farad. Cable capacitance is usually measured in picofarads (pF).
- Capacitive Crosstalk** — Cable crosstalk or interference resulting from the coupling of the electrostatic field of one conductor upon one or more others.
- Capacitive Reactance** — The opposition to alternating current due to the capacitance of a capacitor, cable or circuit. It is measured in ohms and is equal to $1/(2 \cdot \pi \cdot f \cdot C)$ where π is approximately 3.1416, f is the frequency in Hz and C is the capacitance in farads.
- Capacitor** — Two conducting surfaces separated by a dielectric material. The capacitance is determined by the area of the surfaces, type of dielectric and spacing between the conducting surfaces.
- Carrier Strip** — Also referred to as substrate. A film that is on one side of a laminated flat cable.
- CASPIC** — Coated Aluminum, Coated Steel.
- Category** — Rating of a local area network (LAN) cable established by TIA/EIA to indicate the level of electrical performance.
- Category Cables** — Belden manufactures Category 3 to 7 cables, all high performance twisted pair data cables. The higher the category number, the greater the bandwidth. Category 7 is currently the highest performance telecommunication wire available. Ours is certified to applicable UL standards.
- CATV** — Abbreviation for Community Antenna Television. Cable TV.
- CB** — Citizens band.
- CBR** — Constant Bit Rate.
- CCTV** — Closed-circuit television.
- Cellular Polyethylene** — Expanded or "foam" polyethylene, consists of individual closed cells of inert gas suspended in a polyethylene medium. The result is a desirable reduction of the dielectric constant compared to solid polyethylene, which decreases attenuation and increases the velocity of propagation.
- Center-to-Center Distance** — Pitch. Nominal distance from center-to-center of adjacent conductors within a cable. When conductors are flat, pitch is usually measured from the reference edge of a conductor to the reference edge of the adjacent conductor.
- Channel** — The horizontal cable including the workstation outlet and patch panel in the telecommunications closet plus a maximum combined length of up to ten meters of patch cable at each end (maximum length of 100 meters).
- Characteristic Impedance** — In a transmission cable of infinite length, the ratio of the applied voltage to the resultant current at the point the voltage is applied. Or the impedance which makes a transmission cable seem infinitely long, when connected across the cable's output terminals.

Glossary of Terms

- Chrominance Signal** — The portion of a video signal that contains the color information.
- Circuit** — A system of conducting media designed to pass an electric current.
- Circular Mil** — Area of a wire that is one-thousandth of an inch (.001 inch, one mil) in diameter. This area is $\pi/4$ of a square mil. The circular mil area (CMA, cmil) equals the diameter in mils squared. By knowing the CMA of various conductors, they can be used to determine what conductivity and gage size various combinations will produce.
- Cladding** — A low refractive index material that surrounds the core of an optical fiber causing the transmitted light to travel down the core and protects against surface contaminant scattering or a layer of metal applied over another. Cladding is often chosen to improve conductivity or to resist corrosion.
- CO** — Central Office.
- Coaxial Cable** — A cylindrical transmission line composed of a conductor centered inside a metallic tube or shield, separated by a dielectric material, and usually covered by an insulating jacket. Used by cable TV companies to distribute signals to homes and businesses. Also used by telephone companies in some applications and by cellular telephone, radio and television installations.
- Coil Effect** — The inductive effect exhibited by a spiral-wrapped shield, especially above audio frequencies.
- Color Code** — A system of different colors or stripes used to identify components of cables such as individual conductors or groups of conductors.
- COLS** — Commercial Online Service.
- Component Video** — The unencoded output of a camera, video tape recorder, etc., whereby each red, green, and blue video signal is transmitted down a separate cable (usually coax) to improve picture quality. Can also refer to a video system where the luminance and chrominance video components are kept separate.
- Composite Cable** — Cable having conductors with two or more AWG sizes or more than one cable type.
- Composite Video** — The encoded output of a camera, video tape recorder, etc., whereby the red, green and blue video signals are combined with the synchronizing, blanking and color burst signals and are transmitted simultaneously down one cable.
- Concentric Stranding** — A group of uninsulated wires twisted together and containing a center core with subsequent layers spirally wrapped around the core with alternating lay directions to form a single conductor.
- Conductivity** — The ability of a material to allow electrons to flow, measured by the current per unit of voltage applied. It is the reciprocal of resistivity and is measured in siemens (S) or mhos.
- Conductor** — A substance, usually metal, used to transfer electrical energy from point to point.
- Conduit** — A tube of metal or plastic through which wire or cable can be run. Used to protect the wire or cable and, in the case of metal conduit, to contain the fire of a burning wire or cable.
- Connector** — A device designed to allow electrical flow from one wire or cable to a device on another cable. A connector will allow interruption of the circuit or the transfer to another circuit without any cutting of wire or cable or other preparation.
- Copperweld®** — Trademark of Copperweld Steel Co. for copper-clad steel conductor.
- Cord** — A very flexible insulated cable.
- Core** — The light conducting central portion of an optical fiber with a refractive index higher than that of the cladding. The center of a cable construction. Most often applies to a coaxial cable, where the core is the center conductor and the dielectric material applied to it.
- Corona** — The ionization of gasses about a conductor that results when the potential gradient reaches a certain value.
- Coupling** — The transfer of energy (without direct electrical contact) between two or more cables or components of a circuit.
- Coverage** — How well a metal shield covers the underlying surface. Measured in percent.
- CPE** — Chlorinated polyethylene can be used as either a thermoplastic or thermoset. It is a tough chemical- and oil-resistant material and makes an excellent jacket for industrial control cable. As a thermoset, it can be used as an oil-resistant cord jacket. Other outstanding properties include low water absorption and superior crush resistance, which are important attributes in industrial control applications.
- CPS** — Abbreviation for cycles per second. This term has been replaced by Hertz in common usage.
- CPU** — Central Processing Unit.
- Crosstalk** — A type of interference caused by signals from one pair or cable being coupled into adjacent pairs or cables. Can occur with audio, data or RF signals.
- CRT** — Cathode Ray Tube.
- CSA** — Abbreviation for Canadian Standards Association, the Canadian version of the Underwriters Laboratories.
- CSMA/CD** — Carrier Sense Multiple Access/ Collision Detection.
- CSR** — Customer Service Representative.
- CUPIC** — Copper.
- Current Carrying Capacity** — The maximum current a conductor can carry without being heated beyond a safe limit. Ampacity.
- Current Loop** — A two wire transmit/receive interface.
- Current, Alternating (AC)** — Electric current that alternates or reverses polarity in a cyclical manner (e.g. 60 Hz AC power).
- Current, Direct (DC)** — Electrical current whose electrons flow in one direction only and is generally constant.
- Cut-through Resistance** — A test to determine the ability of a material to withstand the application of blades or sharp edges without being cut.
- D1** — A component digital video recording format that conforms to the CCIR-601 standard. Records on 19 mm magnetic tape. (Often used incorrectly to indicate component digital video.)
- D2** — A composite digital video recording format. Records on 19 mm magnetic tape.
- D3** — A composite digital video recording format. Records on 1/2 inch (12.7 mm) magnetic tape.
- Daisy Chain** — A cable assembly with three or more termination areas.
- Datalene®** — Belden trademark for foam polyolefin.
- DAVIC** — Digital Audio Video Council.
- dB** — Decibel.
- DBS** — Direct Broadcast Satellite.
- DC** — Direct current.
- DC Resistance** — See *Resistance*.
- Decibel (dB)** — A decibel is one-tenth of a bel and is equal to 10 times the logarithm of the power ratio, 20 times the log of the voltage ratio, or 20 times the log of the current ratio. Decibels are also used to express acoustic power, such as the apparent level of a sound. The decibel can express an actual level only when comparing with some definite reference level that is assumed to be zero dB.
- Delay Line** — A transmission line or equivalent device designed to delay a wave or signal for a specific length of time.
- DEPIC** — Dual Expanded Plastic Insulated Conductor (Foam Skin). Decreases outside diameter of cable.
- Derating Factor** — A multiplier used to reduce the current carrying capacity of conductors in more adverse environments, such as higher temperature, or where multiple conductors are together in one conduit.
- DES** — Data Encryption Standard.
- DHCP** — Dynamic Host Configuration Protocol.
- Dielectric** — An insulating (nonconducting) medium. It is the insulating material between conductors carrying a signal in a cable. In coaxial cables it is between the center conductor and the outer conductor. In twisted pair cables it is the insulation between conductors plus any surrounding air or other material.
- Dielectric Breakdown** — Any change in the properties of a dielectric that causes it to become conductive. Normally a catastrophic failure of an insulation because of excessive voltage.

Glossary of Terms

Dielectric Constant

— Also called relative permittivity. That property of a dielectric which determines the amount of electrostatic energy that can be stored by the material when a given voltage is applied to it. Actually, the ratio of the capacitance of a capacitor using the dielectric to the capacitance of an identical capacitor using a vacuum (which has a dielectric constant of 1) as a dielectric. A number which indicates the quality of a material to resist holding an electrical charge when placed between two conductors.

Dielectric Heating — The heating of an insulating material when placed in a radio-frequency field, caused by internal losses during the rapid polarization reversal of molecules in the material.

Dielectric Loss — The power dissipated in a dielectric as the result of the friction produced by molecular motion when an alternating electric field is applied.

Dielectric Strength — The voltage an insulation can withstand before it breaks down. Usually expressed as volts per mil.

Dielectric Withstand Voltage — The voltage an insulation can withstand before it breaks down. Usually expressed as volts per mil.

Digital Signal — An electrical signal which possesses two distinct states (on/off, positive/negative).

Dispersion — The cause of bandwidth limitations in an optical fiber. Dispersion causes a broadening of input pulses along the length of the fiber. Two major types are (a) mode dispersion caused by differential optical path lengths in a multimode fiber, and (b) material dispersion caused by a differential delay of various wavelengths of light in a wave guide material.

Distortion — Any undesired change in a wave form or signal.

Distribution Cable — In a CATV system, the transmission cable between the distribution amplifier and the drop cable.

Disturbed Conductor — A conductor that receives energy generated by the field of another conductor or an external source, e.g. the quiet line.

DMT — Discrete Multitone.

DOCSIS — Data Over Cable Service Interface Specification™. Defines interface requirements for cable modems involved in high-speed data distribution over cable television system networks.

Drain Wire — A non-insulated wire in contact with parts of a cable, usually the shield, and used in the termination to that shield and as a ground connection.

Drop Cable — In a CATV system, the transmission cable from the distribution cable to a dwelling.

DSL — Digital Subscriber Line. A technology for bringing high-bandwidth information to homes and small businesses over ordinary copper telephone lines. A DSL line can carry both data and voice signals, with the data part of the line remaining continuously connected. Currently competes with the cable modem in bringing broadband services to homes and small businesses.

Duobond® II — Belden trademark for a laminated shielding tape consisting of heat sensitive adhesive, aluminum foil, polyester or polypropylene and aluminum foil.

Duobond Plus® — Belden trademark for a foil/braid/foil connection with a shorting fold in the outermost shield.

Duofoil® — Belden trademark for a shield in which metallic foil is applied to both sides of a supporting plastic film.

DVB — Digital Video Broadcasting.

E — Voltage (electromotive force).

Earth — British terminology for zero-reference ground.

Edge Margin — Margin.

EFP — Electronic Field Production. Video production for commercials, television shows and other non-news purposes done outside the studio.

EIA — Electronic Industries Association (formerly RMA or RETMA).

Elastomer — Any material that will return to its original dimensions after being stretched or distorted.

Electromagnetic — Referring to the combined electric and magnetic fields caused by electron motion through conductors.

Electromagnetic Coupling — The transfer of energy by means of a varying magnetic field. Inductive coupling.

Electron Volt — A measure of the energy gained by an electron passing through an electric field produced by one volt.

Electrostatic — Pertaining to static electricity or electricity at rest. An electric charge, for example.

Electrostatic Coupling — The transfer of energy by means of a varying electrostatic field. Capacitive coupling.

ELFEXT — Equal Level Far End Crosstalk (dB). A subtraction of attenuation from FEXT. By subtracting the attenuation, ELFEXT negates the effects of attenuation on the interference as it propagates down the cable, thus bringing it to an equal level.

Elongation — The increase in length of a wire or cable caused by longitudinal tension.

EMF — Electromotive force (voltage).

EMI — Electromagnetic Interference.

End of Life Vehicle (ELV) — Refers to EU directive 2000/53/EC (18-SEPT-2000), which bans the use of certain substances in automobiles. This would require the use of a HMF or RoHS compliant cable.

Energy — The capability of doing work.

Energy Dissipation — Loss of energy from a system due to the conversion of work energy into an undesirable form, usually heat. Dissipation of electrical energy occurs when current flows through a resistance.

ENG — Electronic News Gathering.

EPDM — Ethylene-propylene-diene monomer rubber. A chemically cross-linked elastomer with good electrical insulating properties and excellent flexibility at high and low temperatures. It has good insulation resistance and dielectric strength, as well as excellent abrasion resistance and mechanical properties. EPDM has better cut-through resistance than Silicone rubber, which it replaces in some applications.

EPR — Ethylene-propylene copolymer rubber. A material with good electrical insulating properties.

Equilay — More than one layer of helically laid wires with the length of the lay the same for each layer.

ETP — Abbreviation for a copper refining process called Electrolytic Tough Pitch. This process produces a conductor that is 99.95% pure copper (per ASTM B115) resulting in high conductivity.

eV — Electron volt.

Expanded Polyethylene — Expanded or “foam” polyethylene, consists of individual closed cells of inert gas suspended in a polyethylene medium, resulting in a desirable reduction of the dielectric constant.

Extruded Cable — Conductors are simultaneously insulated and the cable is formed by a continuous extrusion process.

f — Frequency.

Farad — A unit of capacity that will store one coulomb of electrical charge when one volt of electrical pressure is applied.

FAS — Fire Alarm and Signal Cable, CSA (Canadian Standards Association) Cable Designation.

FAQ — Frequently Asked Question.

FCFC — Abbreviation for flat conductor flat cable.

FDDI — Fiber Distributed Data Interface.

FEC — Forward Error Correction.

Feedback — Energy that is extracted from a high-level point in a circuit and applied to a lower level. Positive feedback reduces the stability of a device and is used to increase the sensitivity or produce oscillation in a system. Negative feedback, also called inverse feedback, increases the stability of a system as the feedback improves stability and fidelity.

Feeder Cable — In a CATV system, the transmission cable from the head end (signal pickup) to the trunk amplifier. Also called a trunk cable.

FEP — Fluorinated ethylene-propylene. A thermoplastic material with good electrical insulating properties and chemical and heat resistance.

Ferrous — Composed of and/or containing iron. A ferrous metal exhibits magnetic characteristics.

FEXT — Far End Crosstalk. Crosstalk induced on the pairs, measured at the far end of the cable, referenced to the near end input signal. Usually expressed in decibels (dB).

Fiber — A single, separate optical transmission element characterized by core and cladding.

Glossary of Terms

Fiber Optics — Light transmission through optical fibers for communication and signaling. A technology that transmits information as light pulses along a glass or plastic fiber. Optical fiber carries much more information than conventional copper wire and is generally not subject to interference. Most telephone company long-distance lines are optical fiber. See RUS 1755.900.

Fiber to the home (FTTH) — A technology that provides voice, data and video services from the phone company's branch office to local customers over an all-fiber optic link. Still in its infancy, FTTH technology is substantially more expensive and labor-intensive to install and maintain than competing technologies.

Field — An area through which electric and/or magnetic lines of force pass.

Filled — Cables that are gel filled.

Fillers — Non-conducting components cabled with the insulated conductors or optical fibers to impart roundness, flexibility, tensile strength or a combination of all three to the cable.

Flamarrest® — Belden trademark for a plenum grade chloride-based thermoplastic jacketing material with low smoke and low flame spread properties; more flexible than traditional fluorocopolymer jacket materials. Cables jacketed with Flamarrest meet the ANSI/ NFPA Standard 2621-985 (UL-910) Flame Test.

Flame Resistance — The ability of a material not to fuel a flame once the source of heat is removed.

Flat Cable — Also referred to as planar and/or ribbon cable. Any cable with two or more parallel conductors in the same plane encapsulated by insulating material.

Flat Conductor — A conductor with a width-to-thickness ratio of arbitrarily 5 to 1 or greater.

Flat Conductor Cable — A flat cable with a plurality of flat conductors.

Flex Life — The qualification of the number of times a cable may bend before breaking.

Flexibility — The ability of a cable to bend in a short radius. The ability of a cable to lay flat or conform to a surface as with microphone cables.

FlexPoint PCB — Belden's patent-pending 10GX® Module design which reduces the compensation circuitry's time delay, ensuring stable high performance and enabling transmission rates of 625 MHz and data-rates of 10Gb/s.

Floating — Referring to a circuit which has no connection to ground.

Fluorocopolymer — Generic term for PVDF.

FM — Frequency modulation.

Foam Polyethylene — Expanded or "foam" polyethylene, consists of individual closed cells of inert gas suspended in a polyethylene medium, resulting in a desirable reduction of the dielectric constant.

FR-TPE — FR-TPE, flame retarded thermoplastic elastomer, is a rubber-like plastic that has properties similar to rubber yet is processed as a thermoplastic. It is used as the insulation and jacket in an all TPE construction which meets UL 13 and 1277 industrial cable requirements. It has good electrical properties, abrasion resistance, colorability and flame retardance. This compound is ideal for cold weather applications.

FREP — Flame retardant ethylene propylene is a special flame retardant version of EPDM rubber. It is designed for use as an industrial control insulation and has excellent electrical characteristics, deformation resistance and also meets the flame retardant needs of industrial control cables.

Frequency — The number of times a periodic action occurs in one second. Measured in Hertz.

Frequency Response — The amplitude versus frequency characteristics of a device. Also may refer to the range of frequencies over which the device operates within prescribed performance.

Frequency, Power — Normally, the 50 or 60 Hz power used to operate most AC powered equipment. The frequency of AC power supplied by electric utilities companies.

FSK — Frequency Shift Keying.

FTTC — Fiber-to-the-Curb.

Gage — The physical diameter of a wire. A standard for expressing wire diameter. As the AWG number gets smaller, the wire diameter gets larger.

Gain — The increase of voltage, current, or power over a standard or previous reading. Usually expressed in decibels (dB).

Geosol — A solderable, extra tough film insulation developed by Belden for use in geophysical cables and miniature cables.

Giga — One billion.

Gigahertz (GHz) — A unit of frequency equal to one billion Hz.

GND — Ground.

Gopher — Gopher Resistant Copper Alloy. Provides shield and added protection in a single layer.

GOPIC — Gopher.

Graded-Index — A type of optical fiber in which the refractive index of the core is in the form of a parabolic curve, decreasing toward the cladding. This type of fiber provides high bandwidth capabilities.

Ground — An electrical connection between a circuit and the earth. Also refers to a conductor connected to earth. In some instances, can refer to a central metallic point designated as having zero potential.

Ground Conductor — A conductor in a transmission cable or line that is grounded.

Ground Loop — A completed circuit between shielded pairs of a multiple pair created by random contact between shields. An undesirable circuit condition in which interference is created by ground currents when grounds are connected at more than one point.

Ground Potential — The potential of the earth. A circuit, terminal, or chassis is said to be at ground potential when it is used as a reference point for other potentials in the system.

H — Symbolic designation for magnetic field intensity. Abbreviation for henrys (unit of inductance).

Halar® — A Solvay Solexis trademark for thermoplastic fluoropolymer material with excellent chemical resistance, electrical properties, thermal characteristics and impact resistance.

Haloarrest® I — Haloarrest I is a non-halogenated flame retarded thermoplastic polyolefin with excellent low smoke and flame properties. It is used as a jacket over the XLPE insulated singles (non-XHHW), and the entire construction meets the UL 13 and 1277 specifications as a non-halogenated PLTC/TC cable. Haloarrest I meets the European Specifications on acid gas evolution and % Halogen content. This jacket can also be used with XHHW conductors for wet ratings.

Harness — A flat cable or group of cables, usually with many breakouts with the wire ends prepared for termination or terminated to connectors and ready to install.

HDSL — High bit-rate Digital Subscriber Line.

Headroom — The amount by which a cable ACR exceeds the specified requirements. The TIA/EIA-568B standard specifies a minimum of 10 dB of ACR for Category 5e certification at 100 MHz.

Heavy Metal Free (HMF) — General term for a product or material that does not contain restricted heavy metals, such as Lead or Cadmium. See also Restriction of Hazardous Substances.

Henry — Unit of inductance (H) that will produce a voltage drop of one volt when the current changes at the rate of one ampere per second.

Hertz (Hz) — Unit of frequency equal to one cycle per second.

Heterogeneous Insulation — A cable insulating system composed of two or more layers of different insulating materials.

HF — High Frequency. International Telecommunication Union designation for the 3 to 30 MHz band of frequencies.

HFC — Hybrid Fiber/Coaxial.

High Frequency — International Telecommunication Union designation for the 3 to 30 MHz band of frequencies.

Homogeneous Insulation — A complete cable insulation structure whose components cannot be identified as layers of different materials.

Hook-Up Wire — Single conductor wire with various types of insulation.

Horizontal Cable — Cable used between the workstation outlet and the telecommunications closet. Limited to 90 meters maximum per TIA/EIA-568B.1.

HSCDS — High-Speed Cable Data Service.

Glossary of Terms

HTML — Hypertext Markup Language.

HTTP — Hypertext Transfer Protocol.

Hum — Term used to describe noise in an audio, video or other system that comes from 60 Hz power or its harmonic(s). So named for the low-frequency humming sound produced in audio systems. Usually hum is the result of undesired coupling from a 60 Hz source or of inadequate filtering of the DC output of an AC input power supply.

Hypalon® — A DuPont trade name for a synthetic rubber (chlorosulfonated polyethylene) used as insulating and jacketing material for wire and cable.

I — Symbol used to designate current.

I/O Interconnection — Input/Output interface to the outside world.

I²R — Formula for power in watts, where I = current in amperes, R = resistance in ohms.

ICEA — Insulated Cable Engineers Association.

IDC — Insulation Displacement Connector. Type of connector where contact is made to the cable conductor(s) by cutting through the individual conductor's insulation. The conductor does not need to have its insulation removed prior to connection. Flat cable often uses IDCs to simultaneously connect all conductors.

IDSL — ISDN Digital Subscriber Line.

IEEE — Institute of Electrical and Electronic Engineers.

IETF — Internet Engineering Task Force.

IF — Intermediate Frequency.

IFB — Interrupted Feedback (Foldback). A monitoring scheme often used in television where the feed of program audio to an on-air person can be interrupted with directions, cues or other information. Usually integrated into the intercom system.

IGMP — Internet Group Management Protocol.

Impedance — The total opposition that a circuit offers to the flow of alternating current or any other varying current at a particular frequency.

Impedance Match — A condition whereby the impedance of a particular circuit, cable or component is the same as the impedance of the circuit, cable or device to which it is connected.

Impedance Matching Stub — A section of transmission line or pair of conductors cut to match the impedance of a load. Also called matching stub.

Impedance Matching Transformer — A transformer designed to match the impedance of one circuit to that of another.

Impedance, Characteristic — In a transmission cable of infinite length, the ratio of the applied voltage to the resultant current at the point the voltage is applied. Or the impedance which makes a transmission cable seem infinitely long, when connected across the cable's output terminals.

Impedance, High — Generally, the area of 25,000 ohms or higher.

Impedance, Low — Generally, the area of 1 through 600 ohms.

Index Edge — Reference Edge.

Inductance — The property of wire which stores electrical current in a magnetic field around the wire. By coiling wire, the effect can be intensified. It is measured in Henrys.

Induction — The phenomenon of a voltage, magnetic field or electrostatic charge being produced in an object from the source of such fields.

Induction Heating — Heating a conducting material by placing it in a rapidly changing magnetic field. The changing field induces electric currents in the material and losses account for the resultant heat.

Inductive Crosstalk — Crosstalk resulting from the coupling of the electromagnetic field of one conductor upon another.

Injection Laser Diode — Sometimes called the semiconductor diode. A laser in which the lasing occurs at the junction of N-type and P-type semiconductor materials.

INMS — Integrated Network Management System.

Input — A signal (or power) which is applied to a piece of electric apparatus or the terminals on the apparatus to which a signal or power is applied.

Insertion Loss — A measure of the attenuation of a cable and/or component(s) by determining the output of a system before and after the device is inserted into the system.

Insulation — A material having good dielectric properties which is used to separate close electrical components, such as cable conductors and circuit components.

Insulation Displacement Connector (IDC) — A mass termination connector for flat cable with contacts that displace the conductor insulation to complete termination.

Insulation Stress — The molecule separation pressure caused by a potential difference across an insulator. The practical stress on insulation is expressed in volts per mil.

Interface — The region where two systems or a major and a minor system meet and interact with each other.

Interference — Disturbances of an electrical or electromagnetic nature that introduce undesirable responses into other electronic equipment.

Intermediate Frequency — A frequency to which a signal is converted for ease of handling. Receives its name from the fact that it is an intermediate step between the initial and final conversion or detection stages.

Ionization — The formation of ions. Ions are produced when polar compounds are dissolved in a solvent and when a liquid, gas, or solid is caused to lose or gain electrons due to the passage of an electric current.

Ionization Voltage — The potential at which a material ionizes. The potential at which an atom gives up an electron.

IP — Internet Protocol.

IPCDN — IP Over Cable Data Network working group of the IETF.

IR — Insulation Resistance.

IR Drop — The designation of a voltage drop in terms of current and resistance. (See also *Voltage Drop*.)

IRC — Inter Relay Chat.

IRS — Ignition Radiation Suppression.

Integrated Services Digital Network — An alternative to telephone modems that allows digital transmission over ordinary telephone copper wire and other media. Home and business users can get highly graphic Web pages more quickly through ISDN adapters than through dial-up connections.

ISO — International Standards Organization.

Isolation — The ability of a circuit or component to reject interference, usually expressed in dB.

ISP — Internet Service Provider.

ITFS — Instructional Television Fixed Service.

ITU — International Telecommunications Union.

Jacket — Pertaining to wire and cable, the outer protective covering that may also provide additional insulation.

Jumper — A short length of conductor or flat cable used to make a connection between terminals or around a break in a circuit or between circuit boards.

kB — Kilobyte.

keV — 1000 electron volts.

Kilo — One thousand.

KPSI — Tensile strength in thousands of pounds per square inch.

kV — Kilovolt (1000 volts).

kVA — Kilo Volt-ampere. One thousand volt-amperes (VA). (See also *VA*.)

kW — Kilowatt.

L — Symbol for inductance.

Laminated Cable — Insulated or uninsulated wires which are encapsulated by two sheets of laminate material to maintain a predetermined pitch.

LAN — Local Area Network. A data network connecting any number of users, intended to serve a small area. A group of computers and associated devices that shares a common communications line and typically shares the resources of a single processor or server within a small geographic area.

Laser — A coherent source of light with a narrow beam and a narrow spectral bandwidth (about 2nm).

Lay — The length measured along the axis of a wire or cable required for a single strand (in stranded wire) or conductor (in cable) to make one complete turn about the axis of the conductor or cable. In a twisted pair cable, the lay length is the distance it takes for the two wires to completely twist around each other.

Glossary of Terms

- Lay Direction** — The direction of the progressing spiral twist in a cable while looking along the axis of the cable away from the observer. The lay direction can be either left or right.
- Lead Dress** — The placement or routing of wiring and component leads in an electrical circuit.
- Lead Free** — Unless otherwise specified, a homogeneous material containing less than 300ppm of lead (Pb) which is not intentionally added. See also *Heavy Metal Free*.
- Lead-in** — The cable that provides the path for RF energy between the antenna and the receiver or transmitter.
- Leakage** — The undesirable passage of current over the surface of or through an insulator.
- LEC** — Local Exchange Carrier.
- Level** — A measure of the difference between a quantity or value and an established reference.
- LF** — Low frequency. International Telecommunication Union designation for the 30 to 300 kHz band of frequencies.
- Light Emitting Diode (LED Source)** — A semiconductor device that emits incoherent light formed by the P-N junction. Light intensity is roughly proportional to electrical current flow.
- Limpness** — The ability of a cable to lay flat or conform to a surface as with microphone cables. The ability of a cable to bend in a short radius.
- Line Drop** — A voltage loss occurring between any two points in a power or transmission line. Such loss or drop is due to the resistance, reactance or leakage of the line. (See also *Voltage Drop* and *IR Drop*.)
- Line Equalizer** — A reactance (inductance and/or capacitance) connected in series with a transmission line to alter the frequency-response characteristics of the line.
- Line Level** — Refers to the output voltage level of a piece of electronic equipment. Usually expressed in decibels (e.g. 0 dBV).
- Line Voltage** — The value of the potential existing on a supply or power line.
- LMDS** — Local Multipoint Distribution Service
- Load** — A device that consumes power from a source and uses that power to perform a function.
- Loaded Line** — A transmission line that has lumped elements (inductance or capacitance) added at uniformly spaced intervals. Loading is used to provide a given set of characteristics to a transmission line.
- Loading** — A transmission line that has lumped elements (inductance or capacitance) added at uniformly spaced intervals. Loading is used to provide a given set of characteristics to a transmission line.
- Local Area Network** — A data network connecting any number of users, intended to serve a small area. (See also *LAN*.)
- Long-wire Antenna** — An antenna conductor length in excess of one-half of a wavelength.
- Loss** — Energy or signal lost without accomplishing useful work.
- Lossy** — Having high losses resulting in efficiency.
- Low Frequency** — International Telecommunication Union designation for the 30 to 300 kHz band of frequencies.
- Luminance Signal** — The portion of the composite video signal that represents the brightness or the black and white information.
- m** — Prefix for milli or one-thousandth.
- M** — Mutual inductance. The abbreviation for mega or 1 million. And also indicates 1000 (one thousand) feet in the wire industry. Lower case m is for milli or one-thousandth. (See also *m*.)
- M'** — Notation representing 1000 feet.
- mA** — milliampere (one-thousandth of an ampere).
- MAC** — Media Access Control (layer of OSI Reference Model).
- MAN** — Metropolitan Area Network.
- Manufacturing Automation Protocol** — A manufacturing automation protocol based on IEEE 802.4 standards.
- MAP** — Manufacturing Automation Protocol.
- Margin** — Distance between reference edge of cable and nearest edge of first conductor or center of first conductor.
- Mass-Termination** — The process of simultaneously terminating all conductors in a single operation.
- Matrix IDC™** — Belden's patent pending 10GX® Module IDC design which reduces the ANEXT between pairs of adjacent modules by 15dB, enabling transmission rates of 625 MHz and data rates of 10Gb/s.
- Matte Finish PVC** — A special formulation of PVC which very closely looks and feels like rubber.
- MATV** — Abbreviation for Master Antenna Television.
- MB** — Megabyte.
- Mbps** — Mega bits per second. The number of bits, in millions, transmitted per second.
- MCNS** — Multimedia Cable Network System Partners Ltd.
- MDS** — Multipoint Distribution System.
- Mega** — Prefix meaning million.
- Megahertz (MHz)** — Unit of frequency equal to one million Hertz.
- Metropolitan Area Network (MAN)** — A data network intended to serve the area of a city or an area of similar size.
- mfd** — Microfarad (one-millionth of a farad). Modern abbreviation is μF (lower case Greek *mu* followed by F).
- Mho** — The unit of conductance equal to the reciprocal of the unit of resistance (ohm).
- MHz** — Megahertz. (See also *Megahertz*.)
- Micro** — Prefix meaning one-millionth.
- Microfarad** — One-millionth of a farad (μf , μfd , mf and mfd are common abbreviations).
- Micromicrofarad** — One-millionth of a microfarad ($\mu\mu\text{f}$, $\mu\mu\text{fd}$, mmf , mmfd are common abbreviations). Modern usage is picofarad (pF).
- Micron** — Millionth of a meter. (μ is a common abbreviation).
- Microphonics** — Noise caused by mechanical excitation of a system component. In a single-conductor microphone cable, for example, microphonics can be caused by the shield rubbing against the dielectric as the cable is flexed.
- Mil** — A unit of length equal to one thousandth of an inch (.001).
- Milli** — Prefix meaning one-thousandth.
- Mitigation** — Strategies or methods to improve Alien Crosstalk performance in the field for 10G transmission over installed-base cabling.
- Mode** — A single electromagnetic wave traveling in an optical fiber.
- Modem** — Modulator-Demodulator. Device that converts signals in one form to another form compatible with another kind of equipment.
- Modulation** — Altering the characteristics of a carrier wave to convey information. Modulation techniques include amplitude frequency, phase, plus many other forms of on-off digital coding.
- Molded Cable** — Cable assemblies with molded connectors on one or both ends.
- Mono Filament** — A single strand filament as opposed to a braided or twisted filament.
- MSO** — Multiple System Operator. Cable TV term referring to companies that operate multiple cable TV systems in numerous cities.
- MTP** — Simple Mail Transfer Protocol.
- Multi-Conductor Cable** — Cable with more than one conductor.
- Multiplex** — A technique for putting two or more signals into a single channel.
- Mutual Capacitance** — Effective capacitance between two conductors when the effects of the other conductors and shield, if present, are removed.
- mV** — Millivolt (one-thousandth of a volt).
- mW** — Milliwatt (one-thousandth of a watt).
- Mylar®** — DuPont trademark for polyethylene terephthalate (polyester) film.
- N** — Type of coaxial connector named after its inventor, Paul Neil of Bell Labs. Also the symbol for Newton.
- Nano** — One-billionth.
- Nanometer (nm)** — One billionth of a meter.
- Nanosecond** — One billionth of a second.

Glossary of Terms

NAP — Network Access Point.

National Electrical Code (NEC) — A publication of the National Fire Protection Association (NFPA) which outlines requirements for electrical wiring and building construction.

NBR — Butadiene-acrylonitrile copolymer rubber, a material with good oil and chemical resistance.

NEC — National Electrical Code.

NEMA — National Electrical Manufacturers Association.

Neoprene — A synthetic rubber with good resistance to oil, chemical, and flame. Also called polychloroprene.

Network — A method of data communications between computers.

NEXT — Near-end Crosstalk. Crosstalk induced on the pairs, measured at the end near the transmitter. Usually expressed in decibels (dB).

NFPA — National Fire Protection Association.

Nibble — One half byte (4 bits).

NOC — Network Operations Center.

Noise — In a cable or circuit, any extraneous signal which tends to interfere with the signal normally present in or passing through the system.

NOMEX® — DuPont trademark for a temperature-resistant, flame-retardant nylon.

Non-Paired Cable — Cable with two or more cabled conductors that are not in a paired configuration.

Non-Plenum — A description for a cable that does not meet the requirements of NFPA 262 (UL 910) CMP flame test. Such a cable cannot be installed in an area that is used for air return (plenum).

Notch — The removal of the web section between conductors of a flat cable to aid in stripping, slitting and termination.

NTSC — National Television System Committee. Organization that formulated standards for the current U.S. color television system. This system is used in most countries of the Americas and in other parts of the world. It was designed to be compatible with the existing monochrome TV sets, so that they would not become obsolete. Color televisions would also be able to receive monochrome transmissions. NTSC uses a 3.579545 MHz subcarrier whose phase varies with the instantaneous hue of the televised color and whose amplitude varies with the instantaneous saturation of the color. NTSC employs 525 lines per frame, 29.97 frames per second and 59.94 fields per second.

Numerical Aperture (NA) — A measure of the angular acceptance for a fiber. It is approximately the sine of the half-angle of the acceptance cone.

Nylon — An abrasion-resistant thermoplastic with good chemical resistance.

OFDM — Orthogonal Frequency Division Multiplexing.

OFHC — Abbreviation for oxygen-free, high conductivity copper. It has 99.95% minimum copper content and an average annealed conductivity of 101% compared to standard copper.

Ohm — The unit of electrical resistance. The value of resistance through which a potential difference of one volt will maintain a current of one ampere.

Ohm's Law — Stated $E=IR$, $I=E/R$ or $R=E/I$. The current I in a circuit is directly proportional to the voltage E , and inversely proportional to the resistance R .

Optical Waveguide Fiber — A transparent filament of high refractive index core and low refractive index cladding that transmits light.

OSI — Open System Interconnect (Model for networking protocols).

OSS — Operations Support Systems.

Output — The useful power or signal delivered by a circuit or device.

Ozone — Extremely reactive form of oxygen, normally occurring around electrical discharges and present in the atmosphere in small but active quantities. In sufficient concentrations it can break down certain rubber insulations under tension (such as a bent cable).

Paired Cable — Cable with conductors cabled in groups of two.

PAL — Phase Alternation Line. PAL is a European color TV system featuring 625 lines per frame, 25 frames and 50 fields per second. Used mainly in Europe, China, Malaysia, Australia, New Zealand, the Middle East, and parts of Africa. PAL-M is a Brazilian color TV system with 525 lines per frame, 30 frames and 60 fields per second.

Parallel Circuit — A circuit in which the identical voltage is presented to all components, with current dividing among the components according to the resistances or the impedances of the components.

Parallel Digital — Digital information that is transmitted in parallel form. The digits are sent on separate conductors rather than sequentially on one transmission line (serial). Often used informally to refer to parallel digital television signals.

PASP — Polyethylene Aluminum Steel Polyethylene. Provides additional lightning and gopher protection.

Patchcord — A flexible piece of cable terminated at both ends with plugs. Used for interconnecting circuits on a patchboard, in a wiring closet or at the work area.

PC — Personal Computer.

PE — Polyethylene.

Peak — The maximum instantaneous value of a varying current or voltage.

Peel Strength — The force necessary to separate two adjacent conductors of a bonded or laminated flat cable.

Periodicity — The uniformly spaced cable impedance variations that result in addition of the reflections of a signal. The distance between them is the half wavelength of the most affected frequency. Multiples of that frequency are also affected. Even very slight variations, which appear over and over in a construction or installation, can have major effects on signal integrity because of periodicity.

Permanent Link — The horizontal cable including the workstation outlet and patch panel in the telecommunications closet plus two meters of cable at each end for testing. Limited to a maximum of 90 meters in TIA/EIA-568B.1.

PFA — Perfluoroalkoxy.

Phase — An angular relationship between waves.

Phase Shift — A change in the phase relationship between two alternating quantities.

Photodetector (Receiver) — Converts light energy to electrical energy. The silicon photo diode is most commonly used for relatively fast speeds and good sensitivity in the .75 micron to .95 micron wavelength region. Avalanche photodiodes (APD) combine the detection of optical signals with internal amplification of photo-current. Internal gain is realized through avalanche multiplication of carriers in the junction region. The advantage in using an APD is its higher signal-to-noise ratio, especially at high bit rates.

PHY — Physical (layer of OSI Reference Model). (See also *Physical Layer*.)

Physical Layer — The actual portion of a network that is used to physically connect computers of a network and over which the data is transmitted — the cable.

PIC — Plastic Insulated Conductor. Provides strong insulation.

Pickup — Any device which is capable of transforming a measurable quantity of intelligence (such as sound) into relative electrical signals (e.g. a microphone).

Pico — One-trillionth.

Picofarad — One trillionth of a farad. A micromicrofarad. Abbreviated pF in modern usage or mmF in earlier usage.

Pin-diode — A photodetector used to convert optical signals to electrical signals in a receiver. (See also *Photodetector*.)

Pitch — Nominal distance from center-to-center of adjacent conductors within a cable. When conductors are flat, pitch is usually measured from the reference edge of a conductor to the reference edge of the adjacent conductor. Spacing.

Planar Cable — Also referred to as flat and/or ribbon cable. Any cable with two or more parallel conductors in the same plane encapsulated by insulating material.

Plastic — High polymeric substances, including both natural and synthetic products that are capable of flowing under heat and pressure, called thermoplastics. Unlike rubber and other thermoset compounds, plastics can be remelted and reused.

Plasticizer — A chemical added to plastics to make them softer and more flexible.

Plenum — A compartment or chamber to which one or more air ducts are connected and that forms part of the air distribution system. A description for a cable that passes the NFPA 262 (UL-910) CMP flame test requirements.

Plug — A male housing with male or female contacts.

Glossary of Terms

Point-to-Point Wiring — Wiring that consists of continuous conductors terminated at each end to circuit destination.

Polarization — The orientation of a flat cable or a rectangular connector (e.g. for gray flat cable), the colored edge indicating the number one conductor.

Polybutadiene — A type of synthetic rubber often blended with other synthetic rubbers to improve their properties.

Polyethylene (PE) — A thermoplastic material having excellent electrical properties. Low dielectric constant, a stable dielectric constant over all frequencies, very high insulation resistance. In terms of flexibility, polyethylene can be rated stiff to very hard, depending on molecular weight and density — low density being the most flexible and the high-density, high-molecular weight formulation being very hard. Moisture resistance is rated excellent.

Polymer — A substance made of many repeating chemical units or molecules. The term polymer is often used in place of plastic, rubber or elastomer.

Polyolefin — Any of the polymers and copolymers of the ethylene family of hydrocarbons, such as polyethylene and polypropylene.

Polypropylene (PP) — A thermoplastic similar to polyethylene but stiffer and having a higher softening point (temperature). This material is primarily used as an insulation material. Typically, it is harder than polyethylene. This makes it suitable for thin wall insulations. The dielectric constant is 2.25 for solid and 1.55 for cellular designs.

Polyurethane (PUR) — Broad class of polymers noted for good abrasion and solvent resistance. Can be in solid or cellular form. This thermoplastic material is used primarily as a cable jacket material. It has excellent oxidation, oil, and ozone resistance. Some formulations also have good flame resistance. It is a hard material with excellent abrasion resistance. It has outstanding memory properties, making it an ideal jacket material for retractile cords.

Polyvinyl Chloride (PVC) — A general purpose thermoplastic used for wire and cable insulation and jackets.

Portable Cordage — Cable with two or more twisted conductors for flexible applications. Also called flexible cord.

POTS — Plain Old Telephone Service. Sometimes used in discussions of new telephone technologies in which the question of whether and how existing voice transmission for ordinary telephone communication can be accommodated. For example, DSL and ISDN provide part of their channels for POTS, while using most of their bandwidth for digital data transmission.

Potting — Sealing by filling with a substance to exclude moisture.

Power — The amount of work per unit of time. Usually expressed in watts. Power equals the product of voltage and current ($P = V \times I$).

Power Loss — The difference between the total power delivered to a circuit, cable or device and the power delivered by that device to a load.

Power Ratio — The ratio of power appearing at the load to the input power.

PP — Polypropylene.

PPP — Point-to-Point Protocol.

Precision Video — Video coaxial cables having very tight electrical tolerances in impedance, velocity of propagation, attenuation and return loss. Used in high quality applications such as live broadcast in network studios and pre- or post-production facilities.

Premise Cabling — Refers to the entire cabling system used for voice, data, video and power on a user's premise. For Local Area Networks, the cabling of choice includes unshielded twisted pairs (UTP), fiber optic and coaxial cables. Of these, the UTP market is the largest, with greatest demand for cables with four pairs that meet certain standards of performance, such as Category 5 and Category 5e.

PRI — Primary Rate Interface ISDN.

Prop 65 — See *California Proposition 65*.

Propagation Delay — Time required for a signal to pass from the input to the output of a device.

PSALFEXT — Power sum alien equal level far-end crosstalk is a computation of the unwanted signal coupling between pairs in cabling in close proximity from multiple transmit signals at the near-end into another pair measured at the far-end, and relative to the received signal level.

PSAFEXT — Power sum alien far-end crosstalk loss is a computation of the unwanted signal coupling between pairs in cabling in close proximity from multiple transmit signals at the near-end into another pair measured at the far-end.

PSANEXT — Power sum alien near-end crosstalk loss is a computation of the unwanted signal coupling between pairs in cabling in close proximity from multiple transmit signals at the near-end into a pair measured at the near-end.

Pseudo Random NRZ — A wave form of binary signals that may be used in a computer system. It is called NRZ, Non-Return to Zero, because the voltage does not return to zero after each bit.

PSTN — Public Switched Telephone Network.

Pulse — A current or voltage which changes abruptly from one value to another and back to the original value in a finite length of time. Used to describe one particular variation in a series of wave motions.

Put-up — Packaging of finished wire or cable.

PVC — Polyvinyl Chloride. (See also *Polyvinyl Chloride*.)

PVDF — Polyvinylidene Fluoride.

QAM — Quadrature Amplitude Modulation.

QOS — Quality of Service.

QPSK — Quaternary Phase Shift Keying or Quadrature PSK.

Quad — A four conductor cable. Also called star quad.

R — Symbol for resistance.

Radio Frequency (RF) — Radio Frequency. Includes frequencies from a few kilohertz to several gigahertz. Used to transmit information from point to point over the airwaves or cable.

RAM — Random Access Memory.

Rated Temperature — The maximum temperature at which an electric component can operate for extended periods without loss of its basic properties.

Rated Voltage — The maximum voltage at which an electric component can operate for extended periods without undue degradation or safety hazard.

RDC — Regional Data Center.

Reactance — A measure of the combined effects of capacitance and inductance on an alternating current. The amount of such opposition varies with the frequency of the current. The reactance of a capacitor decreases with an increase in frequency; the opposite occurs with an inductance.

Receiver — A unit that converts an RF signal to another type of signal (e.g. radio, television). Also refers to an electronic package that converts light energy to electrical energy in a fiber optic system. (See also *Photodetector*.)

Receptacle — A female housing with male or female contacts.

Reference Edge — Edge of cable or conductor from which measurements are made, such as in flat cable. Sometimes indicated by a thread, identification stripe or printing. Conductors are usually identified by their sequential position from the reference edge, with number one conductor closest to this edge.

Reflection — The change in direction (or return) of waves striking a surface. For example, electromagnetic energy reflections can occur at an impedance mismatch or variation in a transmission line, causing standing waves.

Reflection Loss — The part of a signal which is lost due to reflection of power at a line discontinuity.

Refractive Index — The ratio of light velocity in a vacuum to its velocity in the transmitting medium.

Registration — Alignment of one object with relation to another. In flat cables it involves aligning conductors with contacts or solder pads. Also called register.

Repeater — A receiver and transmitter combination used to regenerate an attenuated signal.

Resistance — In DC circuits, the opposition a material offers to current flow, measured in ohms. In AC circuits, resistance is the real component of impedance, and may be higher than the value measured at DC.

Resonance — An AC circuit condition in which inductive and capacitive reactances interact to cause a minimum or maximum circuit impedance.

Glossary of Terms

Restricted Flame Retardants — Refers to the EU directive 2003/11/EC (6-FEB-2003), which bans the use of Penta- and Octa- BDE compounds. Belden is currently using these substances in certain CPE jacket materials only, and plans to phase out usage by January 2006. Contact Belden Customer Service or visit www.belden.com for product specific details.

Restriction of Hazardous Substances (RoHS) — Refers to the EU directive 2002/95/EC (27-JAN-2003) which bans the use of certain substances as of July 2006. The following items are of primary concern in cables, namely: Asbestos and its compounds, Cadmium and its compounds, Chromium VI and its compounds, Lead and its compounds, Mercury and its compounds, and Polybrominated Biphenyls (pbbs) and their ethers/oxides (PBDEs, PBBEs). Contact Belden Customer Service or visit www.belden.com for product specific details.

Retractile Cord — A cord having specially treated insulation or jacket so that it will retract like a spring. Retractability may be added to all or part of a cord's length.

Return Loss — Measure of signal reflections from a cable or device with a fixed, standard reference impedance on the measuring equipment. Expressed in decibels (dB).

RF — Radio Frequency.

RFI — Radio Frequency Interference.

RFP — Request for Proposals.

RG/U — RG is the abbreviation for radio guide, a military designation for a coaxial cable, and U stands for universal.

RGB — Abbreviation for the three parts of color video signal: red, green and blue. Also refers to multi-coaxial cables carrying these signals.

Ribbon Cable — A flat cable made with parallel round conductors in the same plane. Also referred to as planar and/or flat cable. Any cable with two or more parallel conductors in the same plane encapsulated by insulating material.

Ringing Out — The process of locating or identifying specific conductor paths by means of passing a current through selected conductors.

Riser — The system of pathways that are provided to run riser cables from one floor to another.

RJ-45 — Modular telecommunications connector.

RL — Return Loss.

RMS — Root-mean-square.

Rope Strand — A conductor composed of groups of twisted strands.

Round Conductor Flat Cable (RCFC) — A cable made with parallel round conductors in the same plane.

Routing — The path followed by a cable or conductor.

RSVP — Resource Reservation Protocol.

RTP — Real-Time Transport Protocol.

Rubber (Wire Insulation) — A general term used to describe wire insulations made of thermosetting elastomers, such as natural or synthetic rubbers, neoprene, Hypalon® butyl rubber and others.

RUS 1755.900 (aka PE90) — A specification for fiber optic cables currently in high demand by the telecommunications industry. Only a handful of U.S. manufacturers can produce fiber optic cables to this specification. Belden is one of them.

S-CDMA — Synchronous Code Division Multiple Access.

S-HDSL — Single-pair High bit-rate Digital Subscriber Line.

SAE — Society of Automotive Engineers.

SBR — A copolymer of styrene and butadiene. Also GR-S or Buna-S. Most commonly used type of synthetic rubber.

ScTP — Screened Twisted Pair. Premise network cable with an overall foil shield.

SDI — Serial Digital Interface.

SDSL — Symmetric Digital Subscriber Line.

SEALPIC — Aluminum Shield. Sealed Aluminum.

Self-extinguishing — The characteristic of a material that extinguishes its own flame after the igniting flame is removed.

Self-Support — Undulated core with aluminum, polyethylene and a support strand. For aerial use.

Semiconductor — In wire industry terminology, a material possessing electrical conductivity that falls somewhere between that of conductors and insulators. Usually made by adding carbon particles to an insulator. Not the same as semiconductor materials such as silicon, germanium, etc. Used for making transistors and diodes.

Semi-Solid Dielectric — A coaxial design in which a monofilament of plastic holds the center conductor in place in a hollow plastic tube allowing the remainder of the dielectric to be air. Typical velocities of up to 84% can be achieved in this design.

Separator — Pertaining to wire and cable, a layer of insulating material such as textile, paper, Mylar®, etc., which is placed between a conductor and its dielectric, between a cable jacket and the components it covers, or between various components of a multiple-conductor cable. It can be utilized to improve stripping qualities, flexibility or can offer additional mechanical or electrical protection to the components it separates.

Serial Digital — Digital information that is transmitted in serial form. SDI informally refers to serial digital television signals that conform to the SMPTE 259M standard.

Serial Digital Interface — Informally refers to serial digital television signals that conform to the SMPTE 259M standard.

Series Circuit — A circuit in which the components are arranged end to end to form a single path for current.

Serve Shield — A metallic shield consisting of several strands of wire, helically wound and laid parallel around a cable core in only one direction, as opposed to the two directions with interleaving of a braid shield.

Shannon Capacity — A theoretical calculation of the maximum available data-rate for a channel.

Sheath — Pertaining to wire and cable, the outer protective covering, also called jacket, that may also provide additional insulation.

Shield — A tape, serve or braid (usually copper, aluminum or other conductive material) placed around or between electric circuits or cables or their components, to prevent signal leakage or interference.

Shield Coverage — The optical percentage of a cable actually covered by shielding material.

Shield Effectiveness — The relative ability of a shield to screen out undesirable interference or prevent signal leakage out of the cable. Frequently confused with the term shield coverage.

Shield Percentage — The percentage of physical area of a circuit or cable actually covered by shielding material.

Shielded Armored — Types of Shield: Aluminum, Aluminum/Steel and Copper. Cables that require some sort of shield.

Signal — Any visible or audible indication which can convey information. Also, the information conveyed through a communication system.

Signal Conductor — A conductor in a transmission cable or line that carries electrical signals.

Signal to Noise Ratio — Ratio of desired signal to undesired signal (noise) that is often expressed in decibels. Commonly used interchangeably with Attenuation Crosstalk Ratio (ACR) — the difference between attenuation and crosstalk, measured in decibels (dB), at a given frequency. Important characteristic in networking transmission to assure that signal sent down a twisted pair is stronger at the receiving end of the cable than are any interference signals imposed on that same pair by crosstalk from other pairs.

Silicone — A material made from silicon and oxygen. Can be in thermosetting elastomer or liquid form. The thermosetting elastomer form is noted for high heat resistance. This is a very soft thermoset insulation. It has excellent electrical properties plus ozone resistance, low moisture absorption, weather resistance, and radiation resistance. It typically has low mechanical strength and poor scuff resistance.

Single-mode Fiber — An optical fiber wave guide in which only one mode will propagate. The fiber has a very small core diameter of approximately 8 micro meters. It permits signal transmission at extremely high bandwidths and is generally used with laser diodes.

Single-ended — Unbalanced, such as grounding one side of a circuit or transmission line.

Sinusoidal — Varying in proportion to the sine of an angle or time function. Ordinary alternating current is sinusoidal.

Hypalon is a DuPont trademark.

Glossary of Terms

- SIS** — Single conductor having synthetic thermosetting insulation of heat-resistant, moisture-resistant, flame-retarding grade. Also made with chemically cross-linked polyethylene insulation. Used for switched wiring only.
- Skew Rays** — A ray that does not intersect the fiber axis. Generally, a light ray that enters the fiber core at a very high angle.
- Skin Effect** — The tendency of alternating current to travel only on the surface of a conductor as its frequency increases.
- SMA** — Subminiature A connector commonly used in VHF, UHF, RF and microwave applications.
- SMB** — Subminiature B connector snap-mount connector.
- SMC** — Subminiature C connector.
- Snake Cable** — A name given to individually shielded or individually shielded and jacketed, multi-pair audio cables. Used in the connection of multi-channel line level audio equipment.
- SNMP** — Simple Network Management Protocol.
- SNR** — Signal to Noise Ratio.
- SONET** — Synchronous Optical Network.
- Source** — The device from which a signal is marked into a cable. The device (usually LED or laser) used to convert an electrical information-carrying signal into a corresponding optical signal for transmission by an optical wave guide.
- Spacing** — The distance between the centers of two adjacent conductors. Pitch.
- Span** — The distance between the center of the first conductor and the center of the last conductor in a flat cable.
- Spectral Bandwidth** — The difference between wavelengths at which the radiant intensity of illumination is half its peak intensity.
- Spectrum** — Frequencies that exist in a continuous range and have a common characteristic. A spectrum may be inclusive of many spectrums (e.g. the electromagnetic radiation spectrum includes the light spectrum, radio spectrum, infrared spectrum, etc.).
- Speed of Light (c)** — Approximately 2.998×10^8 meters per second.
- SpiralFlex™** — Belden's patent-pending cable design for the 10GX® Cable which increases randomization and pair separation, enabling transmission rates of 625 MHz and data-rates of 10Gb/s.
- Splitter** — A device that sends the signal from one source to two or more receiving devices by allocating a portion of the signal to each receiver (e.g. cable TV splitter). A device that divides a high bandwidth signal into two or more lower bandwidth signals, each carrying a selected frequency range. Users connected to a DSL line, for example, may have a splitter installed at their home or business to divide the incoming signal into low frequencies to send to their phone and high frequencies for data to the computer.
- SRL** — Structural Return Loss.
- Stalpeth (DUCTPIC)** — Aluminum steel bonded to the polyethylene jacket. Helps minimize jacket damage.
- Standing Wave** — The stationary pattern of waves produced by two waves of the same frequency traveling in opposite directions on the same transmission line. The existence of voltage and current maxima and minima along a transmission line is a result of reflected energy from an impedance mismatch.
- Standing Wave Ratio (SWR)** — A ratio of the maximum amplitude to the minimum amplitude of a standing wave stated in current or voltage amplitudes. (See also *Standing Wave*.)
- Star Quad** — Term given to 4-conductor microphone cables where the conductors are spiraled together, which, when connected in an x configuration, greatly increases common mode noise rejection.
- Static Charge** — An electrical charge that is bound to an object. An unmoving electrical charge.
- Stay Cord** — A component of a cable, usually of high tensile strength, used to anchor the cable ends at their points of termination and keep any pull on the cable from being transferred to the electrical conductors.
- Step Insulated** — Process of applying insulation in two layers. Typically used in shielded networking cables such that the outer layer of insulation can be removed and remaining conductor and insulation can be terminated in a RJ-45 type connector.
- Step-index Fiber** — An optical fiber in which the core is of a uniform refractive index with a sharp decrease in the index of refraction at the core/cladding interface.
- STP** — Shielded Twisted Pair(s).
- Strain Gage** — A device for determining the amount of strain (change in dimensions) when a stress is applied.
- Strand** — A single uninsulated wire.
- Stranded Conductor** — A conductor composed of several strands or groups of uninsulated wires.
- Strip** — To remove insulation from a cable or wire.
- Stripping Groove** — The controlled thinning of the lamination between two conductors in a flat cable to allow easy hand separation. Tear feature.
- Structural Return Loss** — Magnitude of the internal cable reflections, measured in decibels (dB), relative to the actual cable impedance, not the system impedance. Measure of signal reflections caused by the structure of the cable without the additional reflections from any impedance mismatch between the cable and the measuring equipment. Measure of internal cable reflections using a reference impedance in the measuring equipment that is adjusted to the nominal or average impedance of the cable. (See also *Return Loss*.)
- Surge** — A temporary and relatively large increase in the voltage or current in an electric circuit or cable. Also called transient.
- S-Video** — Transmission method for video in which the two parts of the signal, the chrominance and luminance, are sent on separate transmission lines to provide better picture quality.
- Sweep Test** — Testing a characteristic of a cable or device across a range of frequencies. In cable, it usually implies return loss or structural return loss. (See also *Return Loss* or *Structural Return Loss*.)
- TCP/IP** — Transmission Control Protocol/Internet Protocol.
- TDMA** — Time Division Multiple Access.
- Tear Feature** — The controlled thinning of the lamination between two conductors in a flat cable to allow easy hand separation.
- Teflon®** — DuPont Company trademark for fluorocarbon resins.
- Tefzel®** — DuPont Company trademark for a ETFE. Fluorocopolymer thermoplastic material which has excellent electrical properties, heat resistance, chemical resistance, toughness, radiation resistance and flame resistance.
- Temperature Rating** — The maximum temperature at which the insulating material or cable may be used in continuous operation without change in its basic properties.
- Tensile Strength** — The pull stress required to break a bare wire.
- TFE** — Tetrafluoroethylene. A thermoplastic material with good electrical insulating properties and chemical and heat resistance.
- Thermal Rating** — The temperature range in which a material will perform its function without undue degradation.
- Thermoplastic** — A material which will soften, flow or distort appreciably when subjected to sufficient heat and pressure. Examples are polyvinyl chloride and polyethylene.
- Thermoset** — A material which will not soften, flow or distort appreciably when subjected to heat and pressure. Vulcanizable. Examples are rubber and neoprene.
- TIA** — Telecommunications Industry Association. Body which authored the TIA/EIA-568-B Commercial Building Telecommunications Wiring Standard in conjunction with EIA.
- TIA/EIA-568-B** — Commercial Building Telecommunications Wiring Standard defines a generic telecommunications wiring system for commercial buildings that will support a multi-product, multi-vendor environment. It also provides direction for the design of telecommunications products for commercial enterprises.
- Tinsel** — A type of electrical conductor composed of a number of tiny threads, each thread having a fine, flat ribbon of copper or other metal closely spiraled about it. Used for small size cables requiring limpness and extra-long flex life.
- Topcoated Wire** — Conductor produced by applying a layer of tin over a stranded bare copper conductor holding the strands together allowing easier soldering and preventing the fraying of strands.
- TP-PMD** — Twisted Pair-Physical Medium Dependent.

Glossary of Terms

- Transducer** — A device for converting one form of energy to another, such as mechanical energy to electrical energy.
- Transfer Impedance** — For a specified cable length, transfer impedance relates to a current on one surface of a shield to the voltage drop generated by this current on the opposite surface of the shield. Transfer impedance is used to determine shield effectiveness against both ingress and egress of interfering signals. Cable shields are normally designed to reduce the transfer of interference — hence, shields with lower transfer impedance are more effective than shields with higher transfer impedance.
- Transmission Line** — An arrangement of two or more conductors, such as a coaxial cable or a waveguide used to transfer signal energy from one location to another.
- Transmission Line Cable** — Two or more conductors placed within a dielectric material in such a way as to control the electrical characteristics.
- Transmitter** — Equipment that generates RF or electrical signals for transmission through the air or space or over a transmission line. Also refers to the electronic package that converts electrical energy to light energy in a fiber optic system.
- Triad Cable** — Cable with three twisted conductors.
- Triaxial Cable** — A cable construction having a conductor and two isolated braid shields, all insulated from each other. A coaxial cable with a second braid applied over an inner jacket and an outer jacket applied over the outer braid. Commonly used in television camera systems.
- Triboelectric Noise** — Noise generated in a shielded cable due to variations in capacitance between the shield and conductors as the cable is flexed.
- Trunk Cable** — In a CATV system, the transmission cable from the head end (signal pickup) to the trunk amplifier. Also called a feeder cable.
- Turn-key** — A contractual arrangement in which one party designs and installs a system and turns over the keys to another party who will operate the system.
- TVRO** — TV Receive Only.
- Twin-lead** — A transmission line having two parallel conductors separated by insulating material. Line impedance is determined by the diameter and spacing of the conductors and the insulating material and is usually 300 ohms for television receiving antennas.
- Twinax Cable** — Cable with two twisted conductors with established electrical properties (one pair = two conductors sharing a common axis = twinax).
- Twisted Pair** — Two lengths of insulated conductors twisted together. The traditional method for connecting home and many business computers to the telephone company. Gets its name because two insulated copper wires are twisted together, both of which are needed for each connection. In commercial environments, performance of data transmission can be improved by adding a composite tape to the wire. This is known as shielded twisted pair.
- Two-pair Premise Wiring** — Refers to the two pairs of voice grade (low bandwidth) twisted pair wire installed in most homes since the 1950s. The extra pair makes it possible for you to add another line when you need it.
- UHF** — Ultra High Frequency. International Telecommunications Union designation for the 300 to 3000 MHz band of frequencies.
- UL** — Underwriters Laboratories. A nonprofit organization which tests and verifies construction and performance of electronic parts and equipment, including wire and cable.
- UM** — Unsoldered Mechanical Protection. Additional steel and polyethylene over inner polyethylene jacket. Provides additional mechanical protection.
- Unbalanced Line** — A transmission line in which voltages on the two conductors are unequal with respect to ground. A coaxial cable is a common type of unbalanced line.
- Unilay** — A conductor with more than one layer of helically laid wires with the direction of lay and length of lay the same for all layers.
- UTP** — Unshielded Twisted Pair(s).
- V** — Volt. (See also *Volt*.)
- VA** — Volt-ampere. Measure of apparent power in a reactive circuit found by multiplying the voltage by the current.
- VC/MTM** — Variable Constellation/ Multi-Tone Modulation.
- VDSL** — Very high bit rate Digital Subscriber Line.
- Velocity of Propagation (VP)** — The transmission speed of electrical energy in a length of cable compared to speed of light in free space. Usually expressed as a percentage.
- VHF** — Very High Frequency. International Telecommunications Union designation for the 30 to 300 MHz band of frequencies.
- VHS** — Abbreviation for Video Home System.
- Video** — Pertaining to picture information in a television system.
- VLF** — Very Low Frequency. International Telecommunications Union designation for the 3 to 30 kHz band of frequencies.
- Volt** — A unit of electromotive force.
- Voltage** — Electrical potential of electromotive force expressed in volts.
- Voltage Drop** — The voltage developed across a component or conductor by the current flow through the resistance or impedance of the component or conductor.
- Voltage Rating** — The highest voltage that may be continuously applied to a cable construction in conformance with standards or specifications.
- Voltage Standing Wave Ratio** — Ratio of maximum voltage of the standing wave to the minimum voltage of the standing wave. (See also *Standing Wave Ratio*.)
- VSWR** — Voltage Standing Wave Ratio.
- VW-1** — A flammability rating established by Underwriters Laboratories for wires and cables that pass a specially designed vertical flame test, formerly designed FR-1.
- W** — Symbol for watt or wattage.
- Wall Thickness** — The thickness of an insulation or jacket.
- WAN** — Wide Area Network.
- Watt** — A unit of electrical power.
- Wave Form** — A graphical representation of a varying quantity. Usually, time is represented on the horizontal axis, and the current or voltage value is represented on the vertical axis.
- Wavelength** — The distance between positive peaks of a signal. As the frequency increases, and waves get closer together, the wavelength decreases.
- WCS** — Wireless Communications Service.
- Wire** — A conductor, either bare or insulated.
- Wireless** — Really a misnomer. Belden makes a variety of cables needed to build the transmitting infrastructure required to support wireless devices. Wireless is a technology that allows a device (phone, pager or satellite dish) to be unconnected from the transmission point of a voice, video or data signal. The transmission infrastructure required to support such wireless devices is a wired platform of transmission towers and stations that communicate point to point and to telephone central offices.
- X** — Symbol for reactance.
- X-Bar™** — The X-Bar is a plastic device that is used for installing 10GX® Cable onto a 10GX Module, optimizing the termination process and practically eliminating performance variation due to termination variances.
- XLPE** — Crosslinked polyethylene is a thermoset and is crosslinked by radiation, thermally, or by moisture. XLPE offers a wide range of operating temperatures, excellent deformation, abrasion, and flame resistance. XLPE can be formulated with halogenated or non-halogenated flame retardant packages. Some grades are also rated XHHW-2 which offers excellent wet electrical properties.
- XLR** — A multi-pin audio connector (typically 3 pins) used in microphone, line level and snake cable audio connections.
- XPE-PVC** — Expanded Polyethylene-Polyvinyl Chloride. Fire retardant.
- Z** — Symbol for impedance.

Index

Part Numbers

How To Use This Index: All part numbers beginning with a number are listed in numerical sequence; any alpha characters within the part number are ignored for sequencing purposes. All part numbers beginning with an alpha character follow behind the numerical listings in an alpha/numeric sequence. Also use the e-catalog on www.belden.com for part number searches.

Part No.	Page	Part No.	Page	Part No.	Page	Part No.	Page	Part No.	Page
1B25A	21.26	9R28060	7.7	1047A	18.59	1213A	4.21	1420A	5.15
1R25A	21.26	9R28064	7.7	1048A	18.57	1214A	4.21	1421A	5.15
2L28026	7.4	9V28010	7.9	1049A	18.57	1215A	15.80	1422A	5.15
2L28034	7.4	9V28014	7.9	1050A	18.57	1217B	19.22	1423A	5.15
2L28040	7.4	9V28016	7.9	1051A	18.57	1218B	19.22	1424A	5.15
2L28044	7.4	9V28020	7.9	1052A	18.57	1219B	19.22	1425A	5.15
2L28050	7.4	9V28026	7.9	1053A	18.57	1220B	19.22	1426A	6.37, 19.46
5T00UP	19.37, 20.66, 21.22	9V28034	7.9	1054A	18.57	1221B	19.22	1427B	19.22
6T00UP	19.37, 20.68	9V28036	7.9	1055A	18.59	1222B	19.22	1428B	19.22
8R28010	7.8	9V28040	7.9	1056A	18.44	1225B	19.22	1466A	18.47
8R28014	7.8	9V28050	7.9	1057A	18.44	1226B	19.22	1467A	18.47
8R28016	7.8	9V28060	7.9	1058A	18.44	1227A1	15.63	1468A	18.47
8R28020	7.8	9V28064	7.9	1059A	18.44	1229A1	15.63	1471A	18.47
8R28025	7.8	9V28310	7.12	1060A	18.44	1232A1	15.63	1472A	18.47
8R28026	7.8	9V28314	7.12	1061A	18.44	1242A	4.3	1474A	18.47
8R28034	7.8	9V28326	7.12	1062A	18.44	1243A2	15.63	1475A	18.47
8R28037	7.8	9V28334	7.12	1063A	18.57	1245A2	15.63	1476A	18.47
8R28040	7.8	9V28350	7.12	1064A	18.57	1258AM	6.19	1477A	18.47
8R28050	7.8	179DT	19.50, 19.78	1065A	18.57	1260AM	6.23	1480A	18.47
8R28060	7.8	500PTZ	20.42	1066A	18.57	1263B	19.68	1481A	18.47
8R28064	7.8	501PTZ	20.44	1067A	18.57	1266A	5.19, 19.10	1484A	18.49
8V28010	7.10	502PTZ	20.46	1068A	18.57	1268A	5.33	1485A	18.49
8V28014	7.10	538AFS	20.36	1069A	18.59	1269A	5.33, 5.52	1486A	18.49
8V28020	7.10	540BUE	20.9	1070A	18.59	1277P	6.48, 19.71	1489A	18.49
8V28026	7.10	600PTZ	20.43	1071A	18.59	1277R	6.48, 19.71, 21.16	1490A	18.49
8V28036	7.10	601PTZ	20.45	1072A	18.59	1278P	6.48, 19.71	1492A	18.49
8V28040	7.10	602PTZ	20.47	1073A	18.59	1278R	6.48, 19.71, 21.16	1493A	18.49
8V28060	7.10	638AFS	20.35	1074A	18.59	1279P	6.48, 19.71	1494A	18.49
9L26010	7.6	658AFS	20.35	1075A	18.44	1279R	6.48, 19.71, 21.16	1495A	18.49
9L26014	7.6	720A	6.58	1076A	18.44	1280P	6.48, 19.71	1498A	18.49
9L26016	7.6	734A1	6.56	1077A	18.44	1280R	6.48, 19.71, 21.16	1499A	18.49
9L26020	7.6	734A12	6.56	1078A	18.44	1281R	6.34, 19.41, 19.71	1500A	15.54, 20.40, 20.53
9L26025	7.6	734A1P	6.56, 6.58	1079A	18.44	1281S3	6.49, 19.72, 21.17	1500R	15.54
9L26026	7.6	734A6	6.56	1080A	18.44	1281S4	6.49, 19.72, 21.17		20.40, 20.53, 21.10
9L26034	7.6	734D1	6.57	1081A	18.44	1281S5	6.49, 19.72, 21.17	1501A	15.54, 20.41, 20.54
9L26040	7.6	734D12	6.57	1082A	18.44	1281S6	6.49, 19.72, 21.17	1502P	19.39
9L26068	7.6	734D1P	6.57	1083A	18.45	1282P	6.34	1502R	19.39, 21.8
9L28009	7.5	734D1T	6.57	1084A	18.45		19.41, 19.71, 21.16	1503A	5.19, 19.10
9L28010	7.5	734D2	6.57	1085A	18.45	1282S3	6.49, 19.72, 21.17	1504A	5.20, 19.13
9L28014	7.5	734D2T	6.57	1086A	18.45	1282S4	6.49, 19.72, 21.17	1505A	6.29, 6.42, 21.14
9L28015	7.5	734D6	6.57	1087A	18.57	1282S5	6.49, 19.72, 21.17	1505F	6.29, 6.42, 19.52
9L28016	7.5	735A1	6.55	1088A	18.57	1282S6	6.49, 19.72, 21.17	1506A	6.42, 19.52
9L28020	7.5	735A12	6.55	1089A	18.59	1283S3	6.46	1508A	5.16, 19.9
9L28024	7.5	735A16	6.55	1090A	18.59		19.56, 19.73, 21.18	1509C	19.19
9L28025	7.5	735A1P	6.55	1091A	18.44	1283S5	6.46	1510C	19.19
9L28026	7.5	735A1T	6.55	1092A	18.45		19.56, 19.73, 21.18	1511C	19.19
9L28034	7.5	735A2	6.55	1093A	18.58	1283S6	6.46	1512C	19.19
9L28036	7.5	735A24	6.55	1094A	18.58		19.56, 19.73, 21.18	1513C	19.19
9L28037	7.5	735A3	6.55	1095A	18.58	1300A	19.76	1514C	19.19
9L28040	7.5	735A6	6.55	1096A	18.58	1300SB	15.67, 19.76	1515C	19.19
9L28050	7.5	735A8	6.55	1097A	18.60	1304A	19.76	1516C	19.19
9L28060	7.5	735A9	6.55	1098A	18.60	1305A	19.76	1517C	19.19
9L28064	7.5	735O2T	6.55	1099A	18.60	1306SB	6.39, 20.38	1518C	19.19
9L28309	7.11	1000A	18.54	1100A	18.60	1307A	19.36, 21.20	1519C	19.19
9L28310	7.11	1006A	18.54	1101A	18.54	1308A	19.36, 21.20	1520A	6.47, 19.69
9L28315	7.11	1012A	18.54	1114A	18.55	1309A	19.36, 21.20	1521A	6.47, 19.69
9L28320	7.11	1013A	18.54	1115A	18.55	1310A	19.36, 21.20	1522A	6.47, 19.69
9L28325	7.11	1014A	18.54	1116A	18.55	1311A	19.36, 21.20	1523A	6.26
9L28326	7.11	1018A	18.54	1117A	18.55	1312A	19.36, 21.20	1523AN	6.26
9L28334	7.11	1023A	18.54	1118A	18.59	1313A	19.36, 21.20	1523AP	6.26
9L28337	7.11	1030A	18.49	1119A	18.60	1322R	6.24	1523R	6.26
9L28340	7.11	1031A	18.50	1120A	18.57	1401A	15.82	1524AM	6.26
9L28350	7.11	1032A	18.47	1121A	18.58	1403A	15.82	1525A	6.26
9L28360	7.11	1033A	18.44	1151A	6.18	1406B	6.47, 19.69	1526A	18.45
9L30026	7.3	1034A	18.50	1152A	6.25	1407B	6.47, 19.69	1527A	18.59
9L30050	7.3	1035A	18.49	1153A	6.28	1408R	19.18	1528A	18.49
9R28010	7.7	1036A	18.48	1164B	19.70	1409R	19.18	1529A	18.47
9R28014	7.7	1037A	18.59	1167B	6.48, 19.70	1410R	19.18	1530A	6.20
9R28016	7.7	1038A	18.57	1172A	19.8	1411R	19.18	1530AP	6.20
9R28020	7.7	1039A	18.59	1186A	6.17	1412R	19.18	1531AM	6.20
9R28024	7.7	1040A	18.59	1189A	6.24, 21.13	1413R	19.18	1532A	6.20
9R28025	7.7	1041A	18.59	1189AP	6.24, 21.13	1414R	19.18	1533P	15.67
9R28026	7.7	1042A	18.59	1190A	6.25	1415R	19.18	1533R	15.67
9R28034	7.7	1043A	18.59	1191AM	6.24	1416R	19.18	1538A	15.81
9R28037	7.7	1044A	18.59	1192A	19.8	1417B	6.47, 19.69	1540A	15.81
9R28040	7.7	1045A	18.59	1211A	4.21	1418B	6.48, 19.70	1545A	6.19
9R28050	7.7	1046A	18.59	1212A	4.21	1419A	5.15	1546A	6.21



Index

Part Numbers

How To Use This Index: All part numbers beginning with a number are listed in numerical sequence; any alpha characters within the part number are ignored for sequencing purposes. All part numbers beginning with an alpha character follow behind the numerical listings in an alpha/numeric sequence. Also use the e-catalog on www.belden.com for part number searches.

Part No.	Page	Part No.	Page	Part No.	Page	Part No.	Page	Part No.	Page
1583A	15.56, 20.40, 20.53	1829AC	6.31, 21.12	3043A	18.49	5000UP	20.66, 21.22	5300FM	20.64
1583B	15.56	1829B	6.31	3044A	18.50	5000UZ	20.61	5300U1	20.14
1583R	15.56	1829BC	6.31	3045A	18.50	5001UE	20.11, 20.65	5300UE	20.10, 20.65
	20.40, 20.53, 21.11	1829P	6.31, 21.13	3046A	18.50	5002FM	20.64	5300UG	20.8, 21.24
1585A	15.57	1829R	6.31, 21.13	3047A	18.50	5002UP	20.66	5300UP	20.66
	20.41, 20.54, 21.11	1837A	6.21	3048A	18.50	5020FJ	20.57	5301FE	20.13, 20.67
1585B	15.57	1839A	6.32	3049A	18.50	5020FL	20.56	5301UE	20.10, 20.65
1585LC	15.57	1839AC	6.32	3050A	18.49	5020FZ	20.62	5302FE	20.13
1588A	15.56	1840A	6.32	3051A	18.49	5020FM	20.64	5302FM	20.64
1588R	15.56	1840AC	6.32	3052A	18.50	5020FN	20.58	5302GE	20.18
1590A	15.57	1841A	6.32	3053A	18.50	5020UL	20.55	5302UE	20.10
1592A	15.57	1841AC	6.32, 21.12	3054A	18.50	5020UM	20.63	5302UP	20.66
1594A	15.56	1843A	6.33	3055A	18.50	5020UZ	20.61	5303FE	20.13
1613A	6.22	1850F	19.28	3056A	18.49	5022FM	20.64	5303UE	20.10
1614A	6.22	1852F	19.28	3057A	18.49	5022FZ	20.62	5304FE	20.13
1615AM	6.22	1854F	19.28	3064A	18.58	5022UM	20.63	5304FM	20.64
1616AM	6.22	1855A	6.40, 19.50, 21.15	3066A	18.58	5100FE	20.13, 20.67	5304UE	20.10
1617A	6.28	1856A	6.52, 19.60	3067A	18.45	5100FM	20.64	5305FE	20.13
1618A	6.28	1856B	6.52, 19.60	3068A	18.48	5100FZ	20.62	5305UE	20.10
1619AM	6.28	1857A	6.51, 19.59	3069A	18.50	5100UE	20.11, 20.65, 21.21	5306FE	20.13
1620AM	6.28	1858A	6.53, 19.61	3072F	18.18	5100UP	20.66, 21.22	5306FM	20.64
1624P	15.68	1859A	6.53, 19.61	3073F	18.18	5100UZ	20.61	5306UE	20.10
1624R	15.68	1860A	19.34	3074F	18.18	5101FE	20.13, 20.67	5307FE	20.13
1633A	15.69	1861A	19.34	3076F	18.21	5101UE	20.11, 20.65	5307UE	20.10
1634A	15.79	1862A	19.33	3077F	18.21	5102FM	20.64	5308UE	20.10
1668A	15.69	1863A	19.33	3078F	18.21	5102UE	20.11	5309UE	20.10
1671A	6.72	1864A	15.61	3079A	18.21	5102UP	20.66	530BUE	20.10
1671B	6.72	1865A	6.40, 19.50	3079E	18.21	5120FJ	20.57	5320FE	20.13, 20.67
1671J	6.72	1871A	15.61	3081A	18.61	5120FL	20.56	5320FJ	20.57
1672A	6.74, 19.42	1872A	15.48, 15.83	3082A	18.23	5120FM	20.64	5320FL	20.56
1672B	6.74, 19.42	1874A	15.48, 15.83	3082F	18.23	5120FN	20.58	5320FM	20.64
1672J	6.74, 19.42	1875GB	15.72	3082K	18.24	5120FZ	20.62	5320FN	20.58
1673A	6.73	1883A	5.16, 19.9	3082KP	18.24	5120UL	20.55	5320UE	20.10, 20.65
1673B	6.73	1902A	19.20	3083A	18.23	5120UM	20.63	5320UJ	20.57
1673J	6.73	1904A	19.20	3084A	18.23	5120UN	20.58	5320UL	20.55
1674A	6.72	1906A	19.20	3084F	18.23	5120UZ	20.61	5320UM	20.63
1674B	6.72	1908A	19.20	3085A	18.23	5122FL	20.56	5320UN	20.58
1675A	6.73	3000A	18.42	3086A	18.25	5122FM	20.64	5321UE	20.65
1694A	6.44, 19.54, 21.14	3001A	18.43	3087A	18.25	5122FN	20.58	5322FL	20.56
1694SB	6.44, 19.54	3002A	18.43	3088A	18.57	5122UL	20.55	5322FM	20.64
1695A	6.44, 19.54, 21.14	3003A	18.43	3088AE	18.58	5122UM	20.63	5322FN	20.58
1696A	19.27	3004A	18.42	3088CE	18.58	5200FE	20.13, 20.67	5322UE	20.10
1700A	15.50	3005A	18.43	3089A	18.58	5200FM	20.64	5322UL	20.55
1700R	15.50, 21.10	3006A	18.42	3090A	18.59	5200FZ	20.62	5322UM	20.63
1700S6	15.55	3007A	18.43	3090AE	18.60	5200UE	20.10, 20.65, 21.21	5322UN	20.58
1701A	15.50, 21.10	3008A	18.42	3090CE	18.60	5200UP	20.66, 21.22	5324FM	20.64
1701LC	15.50	3009A	18.43	3091A	18.60	5200UZ	20.61	5324UL	20.55
1701S6	15.55	3010A	18.42	3092A	18.19	5201FE	20.13, 20.67	5324UM	20.63
1702A	15.50	3011A	18.43	3092F	18.19, 18.20	5201UE	20.10, 20.65	5326FM	20.64
1703A	15.50	3012A	18.42	3093A	18.19	5202FE	20.13	5326UL	20.55
1752A	15.73	3013A	18.43	3094A	6.84, 15.78, 18.20	5202FM	20.64	5326UM	20.63
1797B	15.40	3014A	18.42	3095A	6.85, 15.78, 18.20	5202UE	20.10, 21.21	5328UL	20.55
1800B	19.27, 21.24	3015A	18.43	3102A	18.52	5202UP	20.66, 21.22	5329UL	20.55
1800F	19.5, 19.27	3016A	18.44	3103A	18.62	5205UE	20.10	5339B5	20.48
1801B	19.27	3017A	18.45	3104A	18.62	5220FJ	20.57	5339G5	6.21
1802B	19.27	3018A	18.45	3105A	18.28	5220FL	20.56	5339Q5	20.48
1803F	19.28	3020A	18.45	3106A	18.28	5220FM	20.64	5339W5	20.37
1804A	19.8	3021A	18.45	3107A	18.28	5220FN	20.58	5340FT	20.33
1805F	19.28	3022A	18.45	3108A	18.28	5220FZ	20.62	5341FE	20.16
1806F	19.28	3023A	18.45	3109A	18.28	5220UJ	20.57	5341PT	20.33
1807A	6.50, 19.77, 21.19	3024A	18.45	3111A	18.54	5220UL	20.55	5341UE	20.15
1808A	6.50, 19.77, 21.19	3025A	18.47	3112A	18.54	5220UM	20.63	5342FE	20.16
1810A	19.37	3027A	18.48	3113A	18.54	5220UN	20.58	5342UE	20.15
1811A	19.37	3028A	18.48	3115A	18.54	5220UZ	20.61	5343FE	20.16
1812A	19.5	3029A	18.46	3118A	18.60	5222FJ	20.57	5343UE	20.15
1813A	19.6	3030A	18.48	3119A	18.27	5222FL	20.56	5345FE	20.16
1814R	19.21	3031A	18.48	3120A	18.27	5222FM	20.64	5345UE	20.15
1815R	19.21	3032A	18.48	3124A	18.26	5222FN	20.58	5347UE	20.15
1816R	19.21	3033A	18.48	3125A	18.26	5222FZ	20.62	5399B5	20.48
1817R	19.21	3034A	18.47	3126A	18.26	5222UL	20.55	5400F1	20.14
1818R	19.21	3035A	18.47	3130A	18.60	5222UM	20.63	5400FE	20.12, 20.67
1819R	19.21	3036A	18.48	3131A	6.84, 15.77, 18.20	5222UN	20.58	5400UE	20.9, 20.65
1820R	19.21	3037A	18.48	3132A	6.84, 15.77, 18.20	5284UE	20.51	5401FE	20.12, 20.67
1821R	19.21	3038A	18.48	5000FE	20.13, 20.67	5284US	20.51	5401GE	20.18
1822R	19.21	3039A	18.48	5000FM	20.64	5288US	20.51	5401UE	20.9, 20.65
1823R	19.21	3041A	18.47	5000FZ	20.62	5300F1	20.14	5402FE	20.12
1829A	6.31, 21.13	3042A	18.47	5000UE	20.11, 20.65, 21.21	5300FE	20.13, 20.67	5402GE	20.18



Index

Part Numbers

How To Use This Index: All part numbers beginning with a number are listed in numerical sequence; any alpha characters within the part number are ignored for sequencing purposes. All part numbers beginning with an alpha character follow behind the numerical listings in an alpha/numeric sequence. Also use the e-catalog on www.belden.com for part number searches.

Part No.	Page	Part No.	Page	Part No.	Page	Part No.	Page	Part No.	Page
5402UE	20.9	6000FE	20.24, 20.69	6341UE	20.25	6626UG	20.29, 20.72	7430A	18.36
5403FE	20.12	6000UE	20.22, 20.68	6342FE	20.26	6641FC	20.31	7434A	18.37
5403UE	20.9	6001UE	20.22, 20.68	6342PC	20.32	6660FT	20.34	7435A	18.37
5405FE	20.12	6002UE	20.22	6342UE	20.25	6661PT	20.34	7436A	18.37
5405UE	20.9	6020FL	20.59	6343FE	20.26	6662UG	20.29, 20.72	7436AS	18.37
5406UE	20.9	6020UL	20.59	6343PC	20.32	7101A	18.32	7438A	18.37
5407FE	20.12	6051	18.91	6343UE	20.25	7102A	18.32	7438AS	18.37
5407UE	20.9	6054	18.91	6345FE	20.26	7105A	18.32	7439A	18.37
5408UE	20.9	6059	18.91	6345PC	20.32	7106A	18.32	7440A	18.37
5409UE	20.9	6060	18.91	6345UE	20.25	7106AS	18.32	7442A	18.37
5421FE	20.67	6100FE	20.24, 20.69	6347FE	20.26	7107A	18.32	7444A	18.37
5439W5	20.37	6100UE	20.22, 20.68, 21.21	6347UE	20.25	7108A	18.32	7445A	18.37
5540FT	20.33	6101FE	20.24, 20.69	6400FC	20.30, 20.70	7110A	18.32	7445AS	18.37
5441FE	20.16	6101UE	20.22, 20.68	6400FE	20.23, 20.69	7111AS	18.32	7447A	18.38
5442FE	20.16	6102UE	20.22	6400UE	20.20, 20.68	7113A	18.32	7447AS	18.38
5445FE	20.16	6120FL	20.59	6401FE	20.23, 20.69	7115A	18.32	7450A	18.38
5500F1	20.14	6120UJ	20.60	6401GE	20.27	7115AS	18.32	7450AS	18.38
5500FE	20.12, 20.67	6120UL	20.59	6401UE	20.28	7116A	18.32	7453A	18.38
5500UE	20.9, 20.65	6122FL	20.59	6402FE	20.23	7117A	18.32	7500A	18.40
5500UG	20.8, 21.24	6122UL	20.59	6402UE	20.20	7122A	18.33	7501A	18.40
5501FE	20.12, 20.67	6139B8	20.49	6403UE	20.20	7123AS	18.33	7502A	18.40
5501G1	20.19	6157	18.94	6405FE	20.23	7125A	18.33	7503A	18.40
5501GE	20.18	6163	18.94	6406UE	20.20	7126A	18.33	7504A	18.40
5501UE	20.9, 20.65	6164	18.94	6407FE	20.23	7127A	18.33	7700A	6.50, 19.77, 21.19
5502FE	20.12	6179	18.94	6420FE	20.23, 20.69	7128A	18.33	7710A	6.46, 19.56
5502G1	20.19	6193	18.94	6439C8	20.49	7129A	18.33	7711A	6.46, 19.56
5502GE	20.18	6200FE	20.24, 20.69	6439Q8	20.49	7136A	18.33	7712A	6.46, 19.56
5502UE	20.9	6200UE	20.21, 20.68, 21.21	6441FE	20.26	7136AS	18.33	7713A	6.46, 19.56, 21.14
5502UG	20.8, 21.24	6201FE	20.24, 20.69	6443FE	20.26	7145A	18.33	7731A	6.44, 19.54
5503FE	20.12	6201UE	20.21, 20.68	6500FC	20.30, 20.70	7200A	18.39	7732A	6.44, 19.54, 19.58
5503UE	20.9	6202FE	20.24	6500FE	20.23, 20.69	7201A	18.39	7733A	6.70
5504FE	20.12	6202UE	20.21	6500UE	20.20, 20.68	7202A	18.39	7787A	6.45, 19.55
5504G1	20.19	6220FK	20.60	6501FE	20.23, 20.69	7203A	18.39	7788A	6.45, 19.55
5504UE	20.9	6220FL	20.59	6501GE	20.27	7205A	18.39	7789A	6.45, 19.55
5506FE	20.12	6220UJ	20.60	6501UE	20.20, 20.68	7206A	18.6, 18.39	7790A	6.45, 19.55
5506UE	20.9	6220UL	20.59	6502FC	20.30, 20.70	7400A	18.34	7791A	6.45, 19.55
5508FE	20.12	6222FL	20.59	6502FE	20.23	7401A	18.34	7792A	6.45, 19.55
5508UE	20.9	6222UL	20.59	6502GE	20.27	7401AS	18.34	7794A	6.45, 19.55
5509UE	20.9	6284UE	20.52	6502UE	20.20	7402A	18.34	7795A	6.45, 19.55
5520FE	20.12, 20.67	6284US	20.52	6504FE	20.23	7402AS	18.34	7796A	6.45, 19.55
5520UE	20.9, 20.65	6288US	20.52	6504UE	20.20	7403A	18.34	7798A	6.45, 19.55
5520UG	20.8, 20.28	6300FC	20.30, 20.70	6506FE	20.23	7403AS	18.34	7803A	6.54, 19.62
5521FE	20.12, 20.67	6300FE	20.24, 20.69	6506UE	20.20	7404A	18.34	7804C	19.64
5521G1	20.19	6300UE	20.21, 20.68	6508FE	20.23	7404AS	18.34	7804R	19.64
5522FL	20.56	6301FE	20.24, 20.69	6508UE	20.20	7405A	18.34	7805	6.59, 6.66
5522G1	20.19	6301UE	20.21, 20.68	6509UE	20.20	7406A	18.34	7805R	6.59, 6.66
5522UE	20.9	6302FC	20.30, 20.70	6520FE	20.23, 20.69	7407A	18.34	7806A	6.60, 6.66
5522UG	20.8, 20.28	6302FE	20.24	6520UE	20.20, 20.68	7408A	18.34	7806R	6.60
5522UL	20.55	6302UE	20.21	6521FE	20.23, 20.69	7409A	18.35	7807A	6.60, 6.66
5524UE	20.9	6303UE	20.21	6521UE	20.20, 20.68	7410A	18.35	7807R	6.60
5524UL	20.55	6304FE	20.24	6522UE	20.20	7411A	18.35	7808A	6.61, 6.66
5526UE	20.9	6304UE	20.21	6522UL	20.59	7411AS	18.35	7808R	6.61
5529UE	20.9	6306FE	20.24	6524UE	20.20	7412A	18.35	7808WB	6.61
5540FT	20.33	6306UE	20.21	6524UL	20.59	7413A	18.35	7809A	6.62
5541FE	20.16	6307FE	20.24	6539Y8	20.39	7413AS	18.35	7809R	6.62
5541PT	20.33	6307UE	20.21	6540FT	20.34	7414A	18.35	7809WB	6.62
5541UE	20.15	6308UE	20.21	6541FE	20.26	7415A	18.35	7810A	6.63, 6.66
5542FE	20.16	6309FE	20.24	6541PA	19.25, 20.32	7415AS	18.35	7810R	6.63
5542GE	20.18	6309UE	20.21	6541PT	20.34	7416A	18.35	7810WB	6.63
5542UE	20.15	6320FE	20.24, 20.69	6541UE	20.25	7416AS	18.35	7813LC	15.53
5543FE	20.16	6320FK	20.60	6542FE	20.26	7417A	18.35	7851A	15.46
5543PE	20.17	6320FL	20.59	6542PA	19.25, 20.32	7417AS	18.35	7851NH	15.46
5543UE	20.15	6320UE	20.21, 20.68	6542UE	20.25	7418A	18.35	7852A	15.46
5545FE	20.16	6320UJ	20.60	6543FE	20.26	7419A	18.35	7855A	19.78
5547UE	20.15	6320UL	20.59	6543PA	19.25, 20.32	7420A	18.35	7876A	21.5
5561FE	20.16	6321UE	20.21, 20.68	6543UE	20.25	7421A	18.36	7876S	21.3
5562FE	20.16	6321UL	20.59	6545FE	20.26	7422A	18.36	7877A	21.5
5563FE	20.16	6322FL	20.59	6545PA	19.25, 20.32	7423A	18.36	7878A	21.6
558AFS	20.36	6322UE	20.21	6545UE	20.25	7423AS	18.36	7878S	21.3
5582UE	20.9	6322UL	20.59	6546PA	19.25, 20.32	7424A	18.36	7880A	19.28
5582UG	20.8	6324UL	20.59	6547FE	20.26	7425A	18.36	7881A	15.52
5600FE	20.12, 20.67	6326UL	20.59	6547UE	20.25	7426A	18.36		20.40, 20.53, 21.9
5624UG	20.28, 20.71	6328UL	20.59	6548PA	19.25, 20.32	7427A	18.36	7882A	15.52
5626UG	20.28, 20.71	6339Q8	20.49	6549PA	19.25, 20.32	7427AS	18.36		20.41, 20.54, 21.9
5660FT	20.33	6340FT	20.34	6561FE	20.26	7428A	18.36	7883A	15.72
5661PT	20.33	6341PC	20.32	6561UE	20.25	7428AS	18.36	7884A	19.17
5662UG	20.28, 20.71	6341PT	20.34	6624UG	20.29, 20.72	7429A	18.36	7885A	19.17



Index

Part Numbers

How To Use This Index: All part numbers beginning with a number are listed in numerical sequence; any alpha characters within the part number are ignored for sequencing purposes. All part numbers beginning with an alpha character follow behind the numerical listings in an alpha/numeric sequence. Also use the e-catalog on www.belden.com for part number searches.

Part No.	Page	Part No.	Page	Part No.	Page	Part No.	Page	Part No.	Page
7886A	19.17	8054	3.25	8255	6.85	8465	4.5	8741	5.4
7887A	19.17	8055	3.25	8259	6.68	8466	4.5	8742	5.4
7888A	19.17	8056	3.25	8261	6.39, 19.48	8467	4.5	8743	5.4
7889A	19.17	8057	3.25	8262	6.77	8468	4.5	8744	5.4
7890A	19.28	8058	3.25	8263	6.36, 19.44	8469	4.5	8747	5.5
7891A	19.28	8073	3.25	8267	6.78	8470	19.33	8748	5.5
7892A	19.28	8074	3.25	8268	6.78	8471	5.9, 19.35	8749	5.5
7893A	19.28	8075	3.25	8279	6.41, 19.51	8472	9.4	8750	5.5
7895A	18.24	8076	3.25	8281	6.30, 6.43, 19.53	8473	5.9, 19.35	8751	5.17
7896A	18.22	8077	3.25	8281B	6.30, 6.43, 19.53	8477	5.9, 19.35	8752	5.18
7897A	18.22	8078	3.25	8281F	6.30, 6.43, 19.52	8478	9.4	8757	5.4
7900A	18.22	8079	3.25	8286	19.67	8479	9.6	8759	5.24, 19.13
7910A	21.5	8080	3.25	8302	5.32	8484	4.8	8760	5.21, 18.29, 19.14
7911A	21.7	8081	3.25	8303	5.32	8486	5.7	8761	5.18, 19.11
7912A	21.7	8083	3.25	8304	5.32	8489	4.5	8762	5.20, 19.13
7913A	21.6	8085	3.25	8305	5.32	8500	3.7	8763	5.47
7913S	21.4	8102	5.31	8306	5.32	8501	3.7	8764	5.37
7914A	21.6	8103	5.31	8307	5.32	8502	3.7	8765	5.37
7914S	21.4	8104	5.31	8308	5.32	8503	3.7	8766	5.37
7915A	6.33, 21.12	8105	5.31	8310	5.32	8504	3.7	8767	5.37
7916A	6.33, 21.12	8106	5.31	8312	5.32	8505	3.7	8768	5.37
7916AP	21.12	8107	5.31	8315	5.32	8520	3.7	8769	5.40, 19.23
7917A	21.7	8108	5.31	8318	5.32	8521	3.7	8770	4.13
7918A	18.10	8110	5.31	8325	5.32	8522	3.7	8771	4.12
7919A	18.10	8112	5.31, 19.57	8332	5.29	8523	3.7	8772	4.12
7921A	18.9	8115	5.31	8333	5.29	8524	3.7	8773	5.40, 19.23
7922A	18.9	8118	5.31	8334	5.29	8525	3.7	8774	5.40, 19.23
7923A	18.8	8125	5.31	8335	5.29	8527	3.7	8775	5.40, 19.23
7924A	18.9	8132	5.27	8336	5.29	8529	3.7	8776	5.40, 19.23
7927A	18.11	8132FO	5.14	8337	5.29	8530	3.7	8777	5.40, 18.29, 19.23
7928A	18.8	8133	5.27	8340	5.29	8538	3.7	8777SB	5.40, 19.12
7929A	18.9	8133FO	5.14	8342	5.29	8597	3.7	8778	5.40, 19.23
7930A	18.10	8134	5.27	8345	5.29	8618	4.13	8780	5.24, 19.15
7931A	18.11	8134FO	5.14	8348	5.29	8619	4.6	8782	19.32
7932A	18.8	8135	5.27	8355	5.29	8620	4.6	8786	4.20
7933A	18.9	8135FO	5.14	8402	19.6	8621	4.6	8787	4.20
7934A	18.8	8138	5.27	8403	19.7	8622	4.6	8788	4.20
7949A	21.8	8138FO	5.14	8404	19.8	8623	4.6	8790	5.24, 19.14
7950A	21.8	8142	5.27, 19.57	8405	19.40	8624	4.6	8791	4.14
7951A	21.8	8142FO	5.14	8406	19.7	8627	4.7	8794	4.3
7952A	21.8	8148	5.27	8407	19.8	8628	4.7	8795	4.3
7956S	21.4	8148FO	5.14	8408	19.6	8629	4.7	8816	3.8
7976A	6.64	8155	5.27	8410	19.4	8641	5.16, 19.9	8824	3.8
7976R	6.64	8155FO	5.14	8412	19.6	8643	4.14	8825	3.8
7976WB	6.64	8162	5.44	8413	19.5	8649	19.32	8866	3.22
7977A	6.65	8163	5.44	8416	19.38	8660	3.26	8868	3.22
7977R	6.65	8164	5.44	8417	19.38	8661	3.26	8869	3.22
7977WB	6.65	8165	5.44	8418	19.40	8662	3.26	8888	9.3
7983A	6.27	8166	5.44	8421	19.38	8663	3.26	8890	3.24
7984A	6.27	8167	5.44	8422	19.6	8668	3.26	8897	3.23
7985LC	20.7, 20.50	8168	5.45	8423	19.7	8669	3.26	8898	3.24
7986LC	20.7, 20.50	8170	5.45	8424	19.8	8670	3.26	8899	3.23
7987P	19.74	8175	5.45	8425	19.40	8673	4.8	8908	3.6
7987R	19.74	8178	5.45	8426	19.40	8675	4.8	8910	3.5
7988P	15.71, 19.75	8185	5.45	8427	19.40	8677	4.8	8915	3.5
7988R	15.71, 19.75	8205	5.7, 19.35	8428	19.6	8678	4.8	8916	3.5
7989P	15.70, 19.75	8208	5.23	8434	5.46	8690	5.8	8917	3.5
7989R	15.70, 19.75	8212	6.37, 19.46	8437	5.23	8691	5.8	8918	3.5
7997A	15.56	8213	6.39, 19.48	8441	5.23	8692	5.8	8919	3.5
8000	3.27	8214	6.69	8442	4.3, 19.35	8700	6.82	8920	3.5
8002	3.27	8215	6.38, 19.47	8443	4.3	8718	5.22, 19.15	9011	6.26
8011	3.27	8216	6.67	8444	4.3	8719	5.22, 19.15	9058	6.23
8012	3.27	8218	6.34, 19.41	8445	4.3	8720	5.22, 19.15	9059M	6.23
8013	3.27	8219	6.68	8446	4.7	8722	5.47	9062	6.23
8018	3.27	8221	6.36, 19.44	8448	4.8	8723	5.38, 18.29, 19.12, 21.24	9064	6.27
8019	3.27	8232	6.51, 19.59	8450	5.18, 19.10	8723SB	5.38, 19.12	9065M	6.27
8020	3.27	8232A	6.51, 19.59	8451	5.19, 19.10	8724	5.46	9066	6.19
8021	3.27	8233	6.54, 19.62	8452	9.5	8725	5.47	9077	6.19
8022	3.27	8233A	6.54, 19.62	8453	9.8	8728	5.46	9100	6.16, 19.46
8023	3.27	8237	6.69	8454	9.9	8729	5.46	9104	6.17
8024	3.27	8238	6.39, 19.48	8455	9.9	8730	5.46	9104N	6.17
8025	3.27	8240	6.68	8456	4.3	8732	5.23	9104P	6.17
8049	3.25	8241	6.35, 19.43	8457	4.4	8734	4.14	9105M	6.17
8050	3.25	8241A	6.35, 19.43	8458	4.4	8735	4.14	9110	6.17
8051	3.25	8241B	6.35, 19.43, 21.15	8459	4.4	8737	5.24, 19.11	9116	6.19, 21.13
8052	3.25	8241F	6.35, 19.43	8460	19.33	8740	5.4	9116P	6.19
8053	3.25	8254	6.85	8461	5.7, 19.35			9116R	6.19



Index

Part Numbers

How To Use This Index: All part numbers beginning with a number are listed in numerical sequence; any alpha characters within the part number are ignored for sequencing purposes. All part numbers beginning with an alpha character follow behind the numerical listings in an alpha/numeric sequence. Also use the e-catalog on www.belden.com for part number searches.

Part No.	Page	Part No.	Page	Part No.	Page	Part No.	Page	Part No.	Page
9116SB	6.19	9329	18.43	9487	18.59	9614	4.17	9813	5.26
9117M	6.19	9330	18.43	9488	18.61	9615	4.17	9814	5.26
9118	6.21	9331	18.43	9489	18.62	9616	4.17	9815	6.87
9119M	6.21	9332	18.43	9491	18.43	9617	4.17	9819	5.26
9141	6.43, 19.53	9333	18.43	9492	18.45	9618	4.17	9825	5.26
9151	19.33	9335	18.43	9493	18.48	9619	4.17	9829	5.30
9154	5.21, 19.13	9341	18.57	9494	18.50	9620	4.6	9830	5.30
9155	5.47	9342	18.59	9495	18.51	9621	4.6	9831	5.30
9156	5.8	9343	18.61	9497	19.33	9622	4.6	9832	5.30
9157	5.8	9344	18.62	9498	4.6	9623	4.7	9833	5.30
9159	5.8	9354	6.91	9501	5.11	9626	4.6	9834	5.30
9160	5.4	9355	6.91	9502	5.11	9637	4.6	9835	5.30
9161	5.8	9356	6.91	9503	5.11	9641	4.16	9836	5.30
9165	19.65	9363	18.43	9504	5.11	9659	6.36, 19.45	9837	5.30
9167	6.29	9364	18.45	9505	5.11	9680	5.15	9838	5.30
9169	6.80	9365	18.48	9506	5.12	9681	5.15	9839	5.30
9170	19.66	9366	18.50	9507	5.12	9682	5.15	9841	5.28
9171	19.66	9367	18.51	9508	5.12	9683	5.15	9842	5.28, 18.3, 18.5
9180	19.27, 19.58	9368	18.46	9509	5.12	9684	5.15	9843	5.28
9182	6.88, 18.17	9369	18.46	9510	5.12	9685	5.46	9844	5.28
9184	5.17	9388	18.46	9512	18.42	9686	4.7	9850	6.79
9192	6.53, 19.61	9389	18.46	9513	18.42	9688	15.79	9855	5.33
9201	6.67	9390	18.46	9514	18.42	9689	15.80	9857	6.80
9203	6.77	9391	18.46	9515	5.12	9696	5.33	9859	6.81
9204	6.79	9392	18.46	9516	18.42	9708	19.32	9860	6.88, 18.17, 19.58
9207	6.88, 18.17	9394	19.4	9519	5.12	9712	19.32	9861	6.78
9209	6.41, 19.51	9395	19.4	9520	18.42	9716	19.32, 21.23	9862	6.80
9209A	6.41, 19.51	9396	19.4	9521	18.42	9717	19.32, 21.23	9867	3.22
9212	6.79	9397	19.5	9524	18.42	9718	19.32, 21.23	9868	4.10
9221	6.34, 19.41	9398	19.7	9525	5.12	9721	4.6	9873	5.42
9222	6.90	9399	19.5	9526	18.42	9728	5.35, 19.29	9874	5.42
9223	6.82	9402	5.41	9527	18.42	9729	5.35, 18.29, 19.29	9875	5.42
9224	6.82	9405	4.8	9531	3.8	9730	5.35, 19.29	9876	5.42
9228	6.85	9406	5.38	9533	4.11	9731	5.35, 19.29	9877	5.42
9231	6.42, 6.58, 19.53	9407	18.42	9534	4.11	9732	5.35, 19.29	9879	5.42
9232	6.53, 19.61	9408	18.44	9535	4.11	9733	5.35, 19.29	9880	6.83, 15.74, 18.13
9239	6.82	9409	18.46	9536	4.11	9734	5.35, 19.29	9883	5.41
9240	6.37, 19.46	9410	18.49	9537	4.11	9735	5.35, 19.29	9886	5.41
9244	6.36, 19.44	9411	18.51	9538	4.11	9736	5.35, 19.29	9888	6.90
9248	6.38, 19.47	9412	18.52	9539	4.11	9737	5.35, 19.29	9890	4.22
9250	6.87, 18.16	9414	5.18	9540	4.11	9738	5.35, 19.29	9891	15.76
9251	6.69	9418	4.13	9541	4.11	9740	5.8	9892	15.76
9252	6.76	9420	4.9, 9.10	9542	4.11	9741	5.8	9894	4.22
9254	19.68	9421	4.3	9543	4.11	9742	5.8	9899	3.23
9258	6.69	9422	4.9, 9.10	9544	4.11	9743	5.8	9901	15.75
9259	6.36, 19.45	9423	4.3	9545	4.11	9744	5.5	9902	15.75
9260	4.14	9424	4.9, 9.10	9546	4.11	9745	5.5	9903	15.75
9261	4.14	9425	4.9, 9.10	9550	5.12	9746	5.5	9904	3.6
9262	19.67	9427	4.9, 9.10	9552	18.46	9747	5.5	9906	3.6
9264	19.38	9429	4.9, 9.10	9553	18.46	9748	5.5	9907	6.83, 15.74, 18.13
9265	19.65	9430	4.3	9554	18.46	9750	5.7	9908	3.6
9267	6.52, 19.60	9431	4.4	9555	6.84	9751	5.7	9909	3.3
9268	6.85	9432	4.4	9556	18.46	9752	5.7	9910	3.5
9269	6.85	9433	4.4	9559	18.46	9755	5.7	9911	3.3
9271	6.88, 18.17	9434	4.4	9562	5.4	9764	6.27	9912	3.5
9272	6.87, 18.16	9438	3.26	9563	18.46	9767	5.40, 19.23	9913	6.70
9273	6.77	9439	4.5	9565	18.46	9768	5.40, 19.23	9913F7	6.70
9274	6.37, 19.46	9444	4.5	9566	5.4	9769	5.40, 19.23	9914	6.70
9275	6.16, 19.46	9445	4.5	9570	5.4	9770	4.12	9916	3.4
9290	6.38, 19.47	9451	5.19, 19.10	9571	4.32	9772	4.20	9917	3.3
9292	6.39, 19.48	9451D	5.19, 19.13	9572	4.32	9773	5.42	9918	3.4
9302	5.17	9451DP	5.19, 19.13	9574	4.32	9774	5.42	9919	3.4
9305	5.17	9451P	5.20, 19.10	9575	4.32	9775	5.42	9920	3.4
9306	5.17	9451SB	5.19, 19.10	9576	4.32	9776	5.42	9921	3.4
9309	5.17	9452	19.6	9578	4.32	9777	5.42	9923	3.4
9310	6.67	9454	19.38	9579	4.32	9778	19.4	9924	3.5
9311	6.68	9455	4.5	9580	4.33	9791	4.16	9925	4.18
9312	18.52	9457	4.5	9581	4.33	9794	4.3	9926	3.4
9314	18.51	9458	4.5	9582	4.33	9802	4.22	9927	4.18
9315	5.17	9460	5.21, 19.14	9583	4.33	9803	4.22	9928	3.4
9316	18.49	9461	5.18, 19.11	9585	5.4	9804	5.26	9929	4.18
9318	18.46	9462	5.18	9588	4.17	9805	5.26	9930	3.4
9319	5.17	9463	6.87, 18.15	9609	4.17	9806	5.26	9931	4.18
9320	18.44	9463DB	18.15	9610	4.17	9807	5.26	9932	4.18
9322	18.42	9463F	18.15	9611	4.17	9808	5.26	9933	4.18
9327	5.17	9464	5.20, 19.13	9612	4.17	9809	5.26	9934	4.18
9328	18.43	9486	18.57	9613	4.17	9812	5.26	9935	4.18



Index

Part Numbers

How To Use This Index: All part numbers beginning with a number are listed in numerical sequence; any alpha characters within the part number are ignored for sequencing purposes. All part numbers beginning with an alpha character follow behind the numerical listings in an alpha/numeric sequence. Also use the e-catalog on www.belden.com for part number searches.

Part No.	Page	Part No.	Page	Part No.	Page	Part No.	Page	Part No.	Page
9936	4.18	19217	9.9	21144	18.77	21221	18.77	21330	18.84
9937	4.18	19227	9.4	21145	18.77	21222	18.77	21331	18.84
9938	4.18	19228	9.4	21146	18.77	21223	18.77	21332	18.84
9939	4.19	19229	9.7	21147	18.77	21224	18.77	21333	18.84
9940	4.19	19230	9.7	21148	18.77	21225	18.77	21334	18.84
9941	4.19	1924A	19.20	21149	18.77	21226	18.77	21335	18.84
9942	4.19	1932A	19.20	21150	18.77	21227	18.77	21336	18.84
9943	4.19	19348	9.7	21151	18.77	21228	18.77	21337	18.84
9944	4.19	19349	9.7	21152	18.77	21229	18.77	21338	18.84
9945	4.19	19350	9.8	21153	18.77	21230	18.77	21339	18.84
9946	4.19	19352	9.7	21154	18.77	21231	18.77	21340	18.84
9947	4.19	19353	9.7	21155	18.77	21232	18.77	21341	18.84
9948	4.19	19354	9.7	21156	18.77	21233	18.77	21342	18.84
9949	4.19	19362	9.7	21157	18.77	21234	18.77	21343	18.84
9950	4.19	19363	9.7	21158	18.77	21235	18.77	21344	18.84
9951	4.15	19364	9.7	21159	18.77	21236	18.77	21345	18.84
9952	4.15	19401	9.9	21160	18.77	21237	18.77	21346	18.84
9953	4.15	19402	9.8	21161	18.77	21238	18.77	21347	18.84
9954	4.15	19403	9.9	21162	18.77	21239	18.77	21348	18.84
9961	4.15	19404	9.3	21163	18.77	21240	18.77	21350	18.84
9962	4.15	19405	9.3	21164	18.77	21241	18.77	21351	18.84
9963	4.15	19500	9.5	21165	18.77	21242	18.77	21352	18.84
9964	4.15	19501	9.5	21166	18.77	21243	18.77	21353	18.84
9965	4.15	19502	9.5	21167	18.77	21244	18.77	21354	18.84
9966	4.15	19503	9.8	21168	18.77	21245	18.77	21355	18.84
9967	4.15	19504	9.8	21169	18.77	21246	18.77	21356	18.84
9968	4.15	19505	9.8	21170	18.77	21247	18.77	21357	18.84
9975	3.3	19506	9.4	21171	18.77	21248	18.77	21358	18.84
9976	3.3	19507	9.4	21172	18.77	21249	18.77	21359	18.84
9977	3.3	19508	9.4	21173	18.77	21250	18.77	21360	18.84
9978	3.3	19509	9.8	21174	18.77	21251	18.77	21361	18.84
9979	3.3	19510	9.8	21175	18.77	21252	18.77	21362	18.84
9980	3.3	19511	9.8	21176	18.77	21253	18.77	21363	18.84
9981	3.3	21100	18.77	21177	18.77	21254	18.77	21364	18.84
9982	3.3	21101	18.77	21178	18.77	21255	18.77	21365	18.84
9983	3.3	21102	18.77	21179	18.77	21256	18.77	21366	18.84
9984	3.3	21103	18.77	21180	18.77	21257	18.77	21367	18.84
9985	3.3	21104	18.77	21181	18.77	21258	18.77	21368	18.84
9986	3.3	21105	18.77	21182	18.77	21259	18.77	21369	18.84
9987	3.3	21106	18.77	21183	18.77	21260	18.77	21370	18.84
9989	3.4	21107	18.77	21184	18.77	21261	18.77	21371	18.84
9990	5.37	21108	18.77	21185	18.77	21262	18.77	21372	18.84
9991	5.37	21109	18.77	21186	18.77	21263	18.77	21373	18.84
9992	5.37	21110	18.77	21187	18.77	21264	18.77	21374	18.84
9993	5.37	21111	18.77	21188	18.77	21265	18.77	21375	18.84
9995	5.37	21112	18.77	21189	18.77	21266	18.77	21376	18.84
9998	9.7	21113	18.77	21190	18.77	21267	18.77	21377	18.84
11700A	18.8	21114	18.77	21191	18.77	21300	18.84	21378	18.84
11700A2	18.8	21115	18.77	21192	18.77	21301	18.84	21379	18.84
11872A	18.11	21116	18.77	21193	18.77	21302	18.84	21380	18.84
19105	9.6	21117	18.77	21194	18.77	21303	18.84	21381	18.84
19106	9.6	21118	18.77	21195	18.77	21304	18.84	21382	18.84
19107	9.6	21119	18.77	21196	18.77	21305	18.84	21383	18.84
19108	9.6	21120	18.77	21197	18.77	21306	18.84	21384	18.84
19109	9.6	21121	18.77	21198	18.77	21307	18.84	21385	18.84
19115	9.3	21122	18.77	21199	18.77	21308	18.84	21386	18.84
1912A	19.20	21123	18.77	21200	18.77	21309	18.84	21387	18.84
19120	9.5	21124	18.77	21201	18.77	21310	18.84	21388	18.84
19122	9.3	21125	18.77	21202	18.77	21311	18.84	21389	18.84
19123	9.3	21126	18.77	21203	18.77	21312	18.84	21390	18.84
19124	9.6	21127	18.77	21204	18.77	21313	18.84	21391	18.84
19125	9.6	21128	18.77	21205	18.77	21314	18.84	21392	18.84
19126	9.3	21129	18.77	21206	18.77	21315	18.84	21393	18.84
19129	9.6	21130	18.77	21207	18.77	21316	18.84	21394	18.84
19130	9.6	21131	18.77	21208	18.77	21317	18.84	21395	18.84
19140	9.5	21132	18.77	21209	18.77	21318	18.84	21396	18.84
1916A	19.20	21133	18.77	21210	18.77	21319	18.84	21397	18.84
19201	9.4	21134	18.77	21211	18.77	21320	18.84	21398	18.84
19202	9.4	21135	18.77	21212	18.77	21321	18.84	21400	18.84
19203	9.4	21136	18.77	21213	18.77	21322	18.84	21401	18.84
19204	9.4	21137	18.77	21214	18.77	21323	18.84	21402	18.84
19205	9.6	21138	18.77	21215	18.77	21324	18.84	21403	18.84
19206	9.6	21139	18.77	21216	18.77	21325	18.84	21404	18.84
19207	9.6	21140	18.77	21217	18.77	21326	18.84	21405	18.84
19208	9.6	21141	18.77	21218	18.77	21327	18.84	21406	18.84
19209	9.6	21142	18.77	21219	18.77	21328	18.84	21407	18.84
19216	9.9	21143	18.77	21220	18.77	21329	18.84	21408	18.84



Index

Part Numbers

How To Use This Index: All part numbers beginning with a number are listed in numerical sequence; any alpha characters within the part number are ignored for sequencing purposes. All part numbers beginning with an alpha character follow behind the numerical listings in an alpha/numeric sequence. Also use the e-catalog on www.belden.com for part number searches.

Part No.	Page	Part No.	Page	Part No.	Page	Part No.	Page	Part No.	Page
21409	18.84	21537	18.84	21616	18.84	22102	18.85	22643	18.78
21410	18.84	21538	18.84	21617	18.84	22103	18.85	22645	18.78
21411	18.84	21539	18.84	21618	18.84	22104	18.85	22646	18.79
21412	18.84	21540	18.84	21619	18.84	22105	18.85	22647	18.78
21413	18.84	21541	18.84	21620	18.84	22106	18.85	22648	18.78
21414	18.84	21542	18.84	21621	18.84	22107	18.85	22654	18.78
21415	18.84	21543	18.84	21622	18.84	22108	18.85	22660	18.78
21416	18.84	21544	18.84	21623	18.84	22110	18.85	22662	18.78
21417	18.84	21545	18.84	21624	18.84	22114	18.85	22663	18.78
21418	18.84	21546	18.84	21625	18.84	22118	18.85	22670	18.78
21419	18.84	21547	18.84	21626	18.84	22120	18.85	22671	18.78
21420	18.84	21548	18.84	21627	18.84	22121	18.85	22672	18.78
21421	18.84	21550	18.84	21628	18.84	22122	18.85	22673	18.78
21422	18.84	21551	18.84	21629	18.84	22123	18.85	22674	18.78
21423	18.84	21552	18.84	21630	18.84	22124	18.85	22675	18.79
21424	18.84	21553	18.84	21631	18.84	22125	18.85	22676	18.78
21425	18.84	21554	18.84	21632	18.84	22126	18.85	22677	18.78
21426	18.84	21555	18.84	21633	18.84	22127	18.85	22678	18.78
21427	18.84	21556	18.84	21634	18.84	22128	18.85	22679	18.78
21428	18.84	21557	18.84	21635	18.84	22130	18.85	22680	18.78
21429	18.84	21558	18.84	21636	18.84	22134	18.85	22681	18.78
21430	18.84	21559	18.84	21637	18.84	22138	18.85	22682	18.78
21431	18.84	21560	18.84	21638	18.84	22140	18.85	22683	18.78
21432	18.84	21561	18.84	21639	18.84	22141	18.85	22684	18.78
21433	18.84	21562	18.84	21640	18.84	22142	18.85	22685	18.79
21434	18.84	21563	18.84	21641	18.84	22143	18.85	22686	18.79
21435	18.84	21564	18.84	21642	18.84	22144	18.85	22687	18.79
21436	18.84	21565	18.84	21643	18.84	22145	18.85	22688	18.79
21437	18.84	21566	18.84	21644	18.84	22146	18.85	22689	18.79
21438	18.84	21567	18.84	21645	18.84	22147	18.85	22690	18.79
21439	18.84	21568	18.84	21646	18.84	22148	18.85	23500	18.81
21440	18.84	21569	18.84	21647	18.84	22150	18.85	23501	18.81
21441	18.84	21570	18.84	21648	18.84	22152	18.85	23503	18.80
21442	18.84	21571	18.84	22000	18.77	22154	18.85	23505	18.80
21443	18.84	21572	18.84	22001	18.77	22160	18.86	23506	18.80
21444	18.84	21573	18.84	22002	18.77	22161	18.86	23507	18.81
21445	18.84	21574	18.84	22003	18.77	22162	18.86	23508	18.80
21446	18.84	21575	18.84	22004	18.77	22170	18.86	23509	18.81
21447	18.84	21576	18.84	22005	18.77	22171	18.86	23510	18.81
21448	18.84	21577	18.84	22006	18.77	22180	18.86	23511	18.80
21500	18.84	21578	18.84	22007	18.77	22181	18.86	23512	18.80
21501	18.84	21579	18.84	22008	18.77	22404	18.82	23513	18.80
21502	18.84	21580	18.84	22009	18.77	22405	18.82	23514	18.80
21503	18.84	21581	18.84	22010	18.77	22409	18.82	23515	18.80
21504	18.84	21582	18.84	22011	18.77	22410	18.82	23516	18.80
21505	18.84	21583	18.84	22012	18.77	22411	18.82	23519	18.80
21506	18.84	21584	18.84	22013	18.77	22412	18.82	23520	18.81
21507	18.84	21585	18.84	22027	18.77	22413	18.82	23521	18.80
21508	18.84	21586	18.84	22028	18.77	22414	18.82	23522	18.81
21509	18.84	21587	18.84	22029	18.77	22415	18.82	23523	18.80
21510	18.84	21588	18.84	22030	18.77	22416	18.82	23524	18.80
21511	18.84	21589	18.84	22031	18.77	22417	18.82	23525	18.81
21512	18.84	21590	18.84	22032	18.77	22418	18.82	23526	18.81
21513	18.84	21591	18.84	22033	18.77	22419	18.82	23527	18.81
21514	18.84	21592	18.84	22034	18.77	22421	18.82	23528	18.80
21515	18.84	21593	18.84	22035	18.77	22442	18.82	23529	18.81
21516	18.84	21594	18.84	22036	18.77	22443	18.82	23530	18.80
21517	18.84	21595	18.84	22037	18.77	22444	18.82	23531	18.80
21518	18.84	21596	18.84	22038	18.77	22445	18.82	23532	18.80
21519	18.84	21597	18.84	22039	18.77	22446	18.82	23533	18.80
21520	18.84	21598	18.84	22040	18.77	22447	18.82	23534	18.80
21521	18.84	21600	18.84	22054	18.77	22448	18.82	23536	18.80
21522	18.84	21601	18.84	22055	18.77	22603	18.79	23537	18.80
21523	18.84	21602	18.84	22056	18.77	22628	18.79	23538	18.81
21524	18.84	21603	18.84	22057	18.77	22629	18.79	23539	18.81
21525	18.84	21604	18.84	22058	18.77	22630	18.79	23541	18.81
21526	18.84	21605	18.84	22059	18.77	22631	18.79	23542	18.80
21527	18.84	21606	18.84	22060	18.77	22632	18.79	23543	18.80
21528	18.84	21607	18.84	22061	18.77	22633	18.78	23544	18.80
21529	18.84	21608	18.84	22062	18.77	22634	18.78	23545	18.80
21530	18.84	21609	18.84	22063	18.77	22635	18.78	23546	18.80
21531	18.84	21610	18.84	22064	18.77	22636	18.78	23547	18.80
21532	18.84	21611	18.84	22065	18.77	22637	18.78	23548	18.80
21533	18.84	21612	18.84	22066	18.77	22638	18.78	23549	18.80
21534	18.84	21613	18.84	22067	18.77	22639	18.78	23550	18.80
21535	18.84	21614	18.84	22100	18.85	22640	18.78	23554	18.80
21536	18.84	21615	18.84	22101	18.85	22641	18.78	23567	18.81



Index

Part Numbers

How To Use This Index: All part numbers beginning with a number are listed in numerical sequence; any alpha characters within the part number are ignored for sequencing purposes. All part numbers beginning with an alpha character follow behind the numerical listings in an alpha/numeric sequence. Also use the e-catalog on www.belden.com for part number searches.

Part No.	Page	Part No.	Page	Part No.	Page	Part No.	Page	Part No.	Page
23568	18.81	26531	18.80	27135A	18.67	27323A	18.65	27846	18.74
23571	18.80	26532	18.80	27136A	18.67	27324A	18.65	27847	18.74
23575	18.80	26533	18.80	27137A	18.67	27325A	18.64	27848	18.74
23578	18.81	26534	18.80	27138A	18.68	27325AS	18.64	27849	18.74
24500	18.83	26535	18.80	27139A	18.68	27326A	18.64	27850	18.74
24501	18.83	26536	18.80	27140A	18.68	27326AS	18.64	27851	18.74
24502	18.83	26537	18.80	27141A	18.68	27327A	18.64	27852	18.74
24503	18.83	26538	18.80	27142A	18.68	27328A	18.64	27853	18.74
24504	18.83	26539	18.80	27143A	18.68	27329A	18.64	27854	18.74
24505	18.83	26540	18.80	27144A	18.68	27330A	18.65	27855	18.74
24506	18.83	26541	18.80	27145A	18.68	27331A	18.65	27856	18.74
24507	18.83	26542	18.80	27146A	18.68	27331AS	18.65	27857	18.74
24508	18.83	26543	18.80	27147A	18.68	27334A	18.64	27858	18.74
24509	18.83	26544	18.80	27148A	18.68	27334AS	18.64	27859	18.74
24510	18.83	26545	18.81	27149A	18.68	27335A	18.64	27860	18.74
24511	18.83	26546	18.80	27150A	18.68	27336A	18.64	27861	18.74
24512	18.83	26547	18.81	27151A	18.68	27337A	18.65	27862	18.74
24513	18.83	26551	18.81	27152A	18.68	27337AS	18.65	27863	18.74
24514	18.83	26553	18.80	27153A	18.68	27338A	18.65	27864	18.74
24515	18.83	26555	18.80	27154A	18.68	27339A	18.65	27865	18.74
24516	18.83	27080A	18.66	27155A	18.69	27340A	18.65	27866	18.75
24517	18.83	27081A	18.66	27156A	18.69	27341A	18.65	27867	18.75
24518	18.83	27081AS	18.66	27157A	18.69	27428	18.73	27868	18.75
24519	18.83	27082A	18.66	27158A	18.69	27429	18.73	27869	18.75
24520	18.83	27082AS	18.66	27159A	18.69	27430	18.73	27870	18.75
25500	18.83	27083A	18.66	27160A	18.69	27431	18.73	27871	18.75
25501	18.83	27084A	18.66	27161A	18.69	27432	18.71	27872	18.75
25502	18.83	27085A	18.66	27243	18.71	27433	18.71	27873	18.75
25503	18.83	27086A	18.66	27244	18.71	27434	18.71	27874	18.75
25504	18.83	27087A	18.66	27245	18.71	27535	18.71	27875	18.75
25505	18.83	27088A	18.66	27246	18.71	27538	18.71	27876	18.75
25506	18.83	27089A	18.66	27247	18.71	27539	18.71	27877	18.75
25507	18.83	27090A	18.66	27248	18.71	27540	18.71	27878	18.75
25508	18.83	27091A	18.66	27249	18.71	27541	18.72	27879	18.75
25509	18.83	27092A	18.66	27250	18.71	27600A	18.64	27880	18.75
25510	18.83	27093A	18.66	27251	18.71	27601A	18.64	27881	18.75
25511	18.83	27094A	18.66	27252	18.71	27602A	18.64	27882	18.75
25512	18.83	27095A	18.66	27253	18.71	27603A	18.64	27883	18.75
25513	18.83	27096A	18.66	27254	18.71	27604A	18.64	27884	18.75
25514	18.83	27097A	18.66	27255	18.71	27605A	18.64	27885	18.74
25517	18.83	27098A	18.66	27256	18.71	27606A	18.64	27886	18.74
25518	18.83	27099A	18.66	27257	18.72	27607A	18.64	27887	18.74
25519	18.83	27100A	18.66	27258	18.72	27608A	18.64	27888	18.76
25520	18.83	27101A	18.66	27259	18.72	27609A	18.64	27889	18.76
25522	18.83	27102A	18.66	27260	18.72	27610A	18.64	27890	18.76
25523	18.83	27103A	18.66	27261	18.72	27611A	18.64	27891	18.76
26500	18.81	27104A	18.66	27262	18.72	27612A	18.64	27892	18.76
26501	18.81	27105A	18.66	27263	18.72	27613A	18.64	27893	18.76
26502	18.81	27106A	18.66	27264	18.73	27614A	18.64	27894	18.75
26503	18.81	27107A	18.66	27265	18.73	27615A	18.65	27895	18.75
26504	18.81	27108A	18.66	27267	18.73	27616A	18.65	27896	18.75
26505	18.81	27109A	18.67	27268	18.73	27617A	18.65	27912A	18.66
26506	18.81	27110A	18.67	27269	18.71	27618A	18.65	27916A	18.64
26507	18.81	27111A	18.67	27270	18.71	27619A	18.65	27917A	18.65
26508	18.81	27112A	18.67	27271	18.71	27620A	18.65	27969	18.71
26509	18.81	27113A	18.67	27272	18.71	27621A	18.65	28243	18.71
26510	18.81	27114A	18.67	27273	18.71	27622A	18.65	28244	18.71
26511	18.81	27115A	18.67	27274	18.71	27623A	18.65	28245	18.71
26512	18.81	27116A	18.67	27275	18.71	27624A	18.65	28246	18.71
26513	18.81	27117A	18.67	27276	18.71	27625A	18.65	28247	18.71
26514	18.80	27118A	18.67	27277	18.71	27626A	18.65	28248	18.71
26515	18.80	27119A	18.67	27278	18.71	27627A	18.65	28249	18.71
26516	18.80	27120A	18.67	27279	18.71	27628A	18.65	28250	18.71
26517	18.80	27121A	18.67	27280	18.71	27629A	18.66	28251	18.71
26518	18.80	27122A	18.67	27281	18.72	27630A	18.67	28252	18.71
26519	18.80	27123A	18.67	27282	18.72	27632A	18.64	28253	18.71
26520	18.80	27124A	18.67	27283	18.72	27633A	18.65	28254	18.71
26521	18.80	27125A	18.67	27284	18.72	27634A	18.67	28255	18.71
26522	18.80	27126A	18.67	27285	18.72	27636A	18.66	28256	18.71
26523	18.80	27127A	18.67	27286	18.72	27641A	18.67	28257	18.72
26524	18.80	27128A	18.67	27287	18.72	27643A	18.68	28258	18.72
26525	18.80	27129A	18.67	27288	18.72	27840	18.74	28259	18.72
26526	18.80	27130A	18.67	27289	18.72	27841	18.74	28260	18.72
26527	18.80	27131A	18.67	27290	18.72	27842	18.74	28261	18.72
26528	18.80	27132A	18.67	27291	18.72	27843	18.74	28262	18.72
26529	18.80	27133A	18.67	27292	18.71	27844	18.74	28263	18.72
26530	18.80	27134A	18.67	27293	18.72	27845	18.74	28264	18.73



Index

Part Numbers

How To Use This Index: All part numbers beginning with a number are listed in numerical sequence; any alpha characters within the part number are ignored for sequencing purposes. All part numbers beginning with an alpha character follow behind the numerical listings in an alpha/numeric sequence. Also use the e-catalog on www.belden.com for part number searches.

Part No.	Page	Part No.	Page	Part No.	Page	Part No.	Page	Part No.	Page
28265	18.73	28877	18.75	30800	3.20	34418	3.16	49616A	8.4
28267	18.73	28878	18.75	30801	3.20	34430	3.16	49617A	8.4
28268	18.73	28879	18.75	30802	3.20	34440	3.16	49635	8.7
28269	18.71	28880	18.75	30804	3.20	34490	3.16	49636	8.7
28270	18.71	28881	18.75	30806	3.20	34914	3.17	49637	8.7
28271	18.71	28882	18.75	30808	3.20	34916	3.17	49642	8.7
28272	18.71	28883	18.75	30810	3.21	34918	3.17	49643	8.7
28273	18.71	28884	18.75	30812	3.21	34920	3.17	49645	8.7
28274	18.71	28885	18.74	30814	3.21	34922	3.17	49668A	8.4
28275	18.71	28886	18.74	30816	3.21	35410	3.15	49669A	8.4
28276	18.71	28887	18.74	30818	3.21	35412	3.15	49673A	8.4
28277	18.71	28888	18.76	30820	3.21	35414	3.15	49674A	8.4
28278	18.71	28889	18.76	30830	3.20	35416	3.15	49675A	8.4
28279	18.71	28890	18.76	30840	3.20	35418	3.15	49676A	8.4
28280	18.71	28891	18.76	3080A	18.61	35420	3.15	49721A	8.3
28281	18.72	28892	18.76	30890	3.20	35606	3.14	49725A	8.3
28282	18.72	28893	18.76	31008	3.15	35608	3.14	49726A	8.3
28283	18.72	28894	18.75	31008N	3.15	35610	3.14	49733	8.7
28284	18.72	28895	18.75	31010	3.15	35612	3.14	49734	8.7
28285	18.72	28896	18.75	31010N	3.15	35614	3.14	49735	8.7
28286	18.72	28969	18.71	31012	3.15	35616	3.14	49736	8.7
28287	18.72	29004	18.88	31012N	3.15	35618	3.14	49737	8.7
28288	18.72	29005	18.88	31014	3.15	35620	3.14	49740A	8.3
28289	18.72	29006	18.88	31014N	3.15	35622	3.14	49745A	8.3
28290	18.72	29007	18.88	31500	3.18	35716	3.14	49746A	8.3
28291	18.72	29008	18.88	31501	3.18	35718	3.14	49747A	8.3
28292	18.71	29009	18.88	31502	3.18	35720	3.14	49760A	8.5
28293	18.72	29016	18.88	31504	3.18	35722	3.14	49761A	8.5
28428	18.73	29017	18.88	31506	3.18	36100	3.17	49765A	8.5
28429	18.73	29018	18.88	31508	3.18	36101	3.17	49766A	8.5
28430	18.73	29019	18.88	31510	3.18	36102	3.17	49802A	8.6
28431	18.73	29020	18.88	31512	3.18	36104	3.17	49900A	8.3
28432	18.71	29021	18.88	31514	3.18	36106	3.17	49901A	8.3
28433	18.71	29022	18.88	31516	3.18	36108	3.17	49902A	8.3
28434	18.71	29023	18.88	31518	3.18	36140	3.17	49905A	8.3
28535	18.71	29024	18.88	31520	3.18	36190	3.17	49906A	8.3
28538	18.71	29025	18.88	31590	3.18	37100	3.12	49907A	8.3
28539	18.71	29030	18.88	32410	3.20	37101	3.12	49911A	8.3
28540	18.71	29031	18.88	32412	3.20	37102	3.12	49950A	8.5
28541	18.72	29032	18.88	32414	3.20	37103	3.12	49951A	8.5
28840	18.74	29033	18.88	32416	3.20	37104	3.12	49952A	8.5
28841	18.74	29034	18.88	32418	3.20	37106	3.12	49955A	8.5
28842	18.74	29035	18.88	32516	3.18	37108	3.12	49956A	8.5
28843	18.74	29036	18.88	32518	3.18	37110	3.12	49957A	8.5
28844	18.74	29038	18.88	32718	3.5	37112	3.12	81553	6.81
28845	18.74	29040	18.88	32720	3.5	37114	3.12	82108	6.18
28846	18.74	29043	18.88	32722	3.5	37116	3.12	82120	6.25
28847	18.74	29048	18.88	32820	3.4	37118	3.12	82240	6.68
28848	18.74	29053	18.88	32822	3.4	37130	3.12	82241	6.35, 19.43
28849	18.74	29058	18.88	33302	3.19	37140	3.12	82248	6.38, 19.47
28850	18.74	29068	18.88	33304	3.19	37190	3.12	82259	6.36, 19.45
28851	18.74	29078	18.88	33306	3.19	37212	3.13	82262	6.86
28852	18.74	29500	18.30	33308	3.19	37214	3.13	82269	6.86
28853	18.74	29501	18.30	33310	3.19	37216	3.13	82418	4.13, 4.24
28854	18.74	29502	18.30	33312	3.19	37218	3.13	82442	4.4, 4.23, 5.6, 5.48
28855	18.74	29503	18.30	33314	3.19	37220	3.13	82444	4.4, 4.23
28856	18.74	29504	18.30	33316	3.19	37222	3.13	82489	4.6, 4.23
28857	18.74	29505	18.30	33318	3.19	37500	3.13	82502	5.13, 5.49
28858	18.74	29506	18.30	33320	3.19	37501	3.13	82503	5.13, 5.49
28859	18.74	29507	18.30	33322	3.19	37502	3.13	82504	5.13, 5.49
28860	18.74	29528	18.30	33390	3.19	37504	3.13	82505	5.13, 5.49
28861	18.74	29529	18.30	33414	3.19	37506	3.13	82506	5.13, 5.49
28862	18.74	29530	18.30	33416	3.19	37508	3.13	82509	5.13, 5.49
28863	18.74	29531	18.30	33418	3.19	37530	3.13	82512	5.49
28864	18.74	29532	18.30	34017	3.21	37540	3.13	82641	5.13, 5.16, 5.49, 19.9
28865	18.74	29550	18.95	34020	3.21	37590	3.13	82688	15.79
28866	18.75	29551	18.95	34400	3.16	39018	3.24	82689	15.80
28867	18.75	29552	18.95	34401	3.16	49103A	8.9	82723	5.38, 5.54, 19.12
28868	18.75	29553	18.95	34402	3.16	49152A	8.8	82729	5.36, 5.53, 19.30
28869	18.75	29554	18.95	34403	3.16	49153A	8.8	82740	5.9, 5.48
28870	18.75	29555	18.95	34404	3.16	49154A	8.8	82741	5.6, 5.48
28871	18.75	29556	18.95	34406	3.16	49402	8.10	82742	5.6, 5.48
28872	18.75	29557	18.95	34408	3.16	49440	8.10	82743	5.6, 5.48
28873	18.75	29558	18.95	34410	3.16	49441	8.10	82757	5.6, 5.48
28874	18.75	29559	18.95	34412	3.16	49442	8.10	82760	5.21, 5.51, 19.14
28875	18.75	29560	18.95	34414	3.16	49502A	8.11	82761	5.20, 5.51, 19.11
28876	18.75	29561	18.95	34416	3.16	49615A	8.4	82777	5.41, 5.54, 19.24



Index

Part Numbers

How To Use This Index: All part numbers beginning with a number are listed in numerical sequence; any alpha characters within the part number are ignored for sequencing purposes. All part numbers beginning with an alpha character follow behind the numerical listings in an alpha/numeric sequence. Also use the e-catalog on www.belden.com for part number searches.

Part No.	Page	Part No.	Page	Part No.	Page	Part No.	Page	Part No.	Page
82778	5.41, 5.54, 19.24	83569	4.25	88240	6.68	22208231	15.16	23598254	15.43
82841	5.28, 5.52	83602	4.26	88241	6.35, 19.43	22208235	15.16	23598257	15.43
82842	5.28, 5.52	83604	4.26	88281	6.43, 19.53	22208250	15.16	24501829	15.65
82907	6.83, 15.74	83606	4.26	88442	4.4, 4.23, 5.6, 5.48	22208253	15.16	24501837	15.65
83000	3.10	83609	4.26	88444	4.4, 4.23	22208260	15.16	24501848	15.65
83001	3.10	83612	4.26	88489	4.23	22208265	15.16	24501858	15.65
83002	3.10	83652	4.26	88641	5.13, 5.16, 5.49, 19.9	22208270	15.16	24501877	15.65
83003	3.10	83653	4.26	88723	5.38, 5.54 18.29, 19.12	22214348	15.45	24501887	15.65
83004	3.10	83654	4.26	88741	5.6, 5.48	22214500	15.45	24501897	15.65
83005	3.10	83656	4.26	88757	5.6, 5.48	22214700	15.45	24501906	15.65
83006	3.10	83659	4.26	88760	5.21, 5.51, 19.14	22214900	15.45	24501922	15.64
83007	3.10	83662	4.26	88761	5.20, 5.51, 19.11	22213010	15.66	24501934	15.64
83008	3.10	83702	4.27	88770	4.13, 4.24	22213020	15.66	24501941	15.64
83009	3.11	83703	4.27	88777	5.41, 5.54, 19.24	22213030	15.66	24501947	15.64
83010	3.11	83704	4.27	88778	5.41, 5.54, 19.24	22213035	15.66	24501950	15.64
83023	3.9	83706	4.27	89108	6.18	22213040	15.66	24566315	15.49
83025	3.9	83709	4.27	89120	6.25	22213045	15.66	24566345	15.49
83026	3.9	83712	4.27	89182	6.88, 18.17	22213050	15.66	24566915	15.49
83027	3.9	83715	4.27	89207	6.88	22213060	15.66	24566945	15.49
83028	3.9	83719	4.27	89248	6.38, 19.47	22213070	15.66	24567315	15.49
83029	3.9	83752	4.34	89259	6.36, 19.45	22213080	15.66	24567345	15.49
83030	3.9	83753	4.34	89269	6.86	22213090	15.66	24567915	15.49
83041	3.11	83754	4.34	89272	6.87	23338077	15.43	24567945	15.49
83043	3.11	83756	4.34	89292	6.39, 19.48	23398107	15.43	24568005	15.49
83045	3.11	83802	4.34	89418	4.13, 4.24	23398255	15.43	24570036	15.62
83046	3.11	83803	4.34	89463	18.15	23398257	15.43	24570086	15.62
83047	3.11	83804	4.34	89503	5.13, 5.49	23398355	15.43	24570152	15.62
83048	3.11	83806	4.34	89504	5.13, 5.49	23398505	15.43	24570157	15.51
83049	3.11	83900	18.55	89505	5.13, 5.49	23398507	15.43	24570161	15.51
83050	3.11	83905	18.55	89555	6.84	23398667	15.43	24570166	15.51
83242	6.77	83910	18.55	89696	5.33, 5.52	23498077	15.43	24570452	15.51
83264	6.79	83915	18.55	89705	5.53, 19.30	23498105	15.43	24570460	15.51
83265	6.76	83930	18.55	89728	5.36, 5.53, 19.30	23498107	15.43	24570521	15.10
83266	6.80	83932	18.55	89729	5.36, 5.53, 19.30	23498155	15.43	24570700	15.62
83267	6.84	83934	18.55	89730	5.36, 5.53, 19.30	23498255	15.43	24570750	15.62
83269	6.67	83950	18.55	89731	5.36, 5.53, 19.30	23498257	15.43	24570800	15.51
83284	6.76	83951	18.55	89732	5.36, 5.53, 19.30	23498355	15.43	24570808	15.51
83303E	4.30	83952	18.55	89733	5.36, 5.53, 19.30	23498505	15.43	24570810	15.51
83304E	4.30	83953	18.55	89734	5.53, 19.30	23498507	15.43	24570812	15.51
83305E	4.30	83954	18.55	89740	5.9, 5.48, 18.4	23498667	15.43	24571097	15.64
83306E	4.31	83955	18.55	89757	5.53, 19.30	23518027	15.43	24571110	15.64
83307E	4.31	84142	6.77	89758	5.53, 19.30	23518047	15.43	24571111	15.64
83308E	4.31	84303	6.77	89841	5.28, 5.52	23518077	15.43	24571112	15.64
83317E	4.30	84316	6.76	89842	5.28, 5.52	23518107	15.43	24571221	15.65
83318E	4.30	85102	4.28	89855	5.33, 5.52	23518157	15.43	24571235	15.65
83319E	4.30	85103	4.28	89880	6.83, 15.74, 18.13	23518257	15.43	24571250	15.65
83320E	4.31	85105	4.28	89892	15.76	23528027	15.43	24571265	15.65
83321E	4.31	85107	4.28	89901	15.75	23528047	15.43	24571266	15.65
83322E	4.31	85109	4.28	89907	6.83, 15.74, 18.13	23528077	15.43	24572238	15.59
83332E	4.30	85164	5.11	89913	6.70	23528107	15.43	24572250	15.59
83333E	4.30	85168	5.11	121700A	18.10	23528157	15.43	24572260	15.59
83334E	4.30	85220	4.28	121700R	18.10	23528257	15.43	24572351	15.59
83335E	4.31	85221	4.28	121872A	18.11	23538027	15.43	24572352	15.59
83336E	4.31	85230	4.29	123092A	18.19	23538047	15.43	24572353	15.59
83337E	4.31	85231	4.29	123107A	18.28	23538077	15.43	24576125	15.58
83347E	4.30	85240	4.29	129463	18.16	23538107	15.43	24577125	15.58
83348E	4.30	85241	4.29	139463	18.16	23538157	15.43	24577815	15.10
83349E	4.30	86262	6.86	183092A	18.19	23538257	15.43	24586385	15.47
83350E	4.31	87120	6.25	189463	18.16	23548027	15.43	24586985	15.47
83351E	4.31	87269	6.86	513945	20.37	23548047	15.43	24588085	15.47
83352E	4.31	87723	5.38, 5.54, 19.12	533945	20.37	23548077	15.43	24587385	15.47
83393	4.29	87740	5.9, 5.48	539945	20.38, 21.25	23548107	15.43	24587985	15.47
83394	4.29	87760	5.21, 5.51, 19.14	543945	20.37, 21.25	23548157	15.43	24812395	15.8
83395	4.29	87761	5.20, 5.51, 19.11	549945	20.38, 21.25	23548257	15.43	24816395	15.8
83396	4.29	87777	5.41, 5.54, 19.24	551945	20.37	23568027	15.43	24816995	15.8
83503	4.25	87778	5.41, 5.54, 19.24	573945	20.37	23568047	15.43	24817395	15.8
83504	4.25	88102	5.50	579945	20.38	23568077	15.43	24817995	15.8
83506	4.25	88103	5.50	613948	20.39	23568107	15.43	24818095	15.8
83509	4.25	88104	5.50	633938	20.49	23568157	15.43	24822395	15.8
83512	4.25	88105	5.50	633948	20.39	23568257	15.43	24826395	15.8
83515	4.25	88106	5.50	639948	20.38	23598027	15.43	24826995	15.8
83552	4.25	88107	5.50	643948	20.39	23598047	15.43	24827395	15.8
83553	4.25	88109	5.50	649948	20.38	23598074	15.43	24827995	15.8
83554	4.25	88112	5.50	673948	20.39	23598077	15.43	24828095	15.8
83556	4.25	88118	5.50	679948	20.38	23598107	15.43	25500027	15.60
83559	4.25	88125	5.50	22208010	15.16	23598154	15.43	25500028	15.60
83562	4.25	88232	6.51, 19.59	22208067	15.16	23598157	15.43	70100390	16.6



Index

Part Numbers

How To Use This Index: All part numbers beginning with a number are listed in numerical sequence; any alpha characters within the part number are ignored for sequencing purposes. All part numbers beginning with an alpha character follow behind the numerical listings in an alpha/numeric sequence. Also use the e-catalog on www.belden.com for part number searches.

Part No.	Page	Part No.	Page	Part No.	Page	Part No.	Page	Part No.	Page
70101714	16.6	A0407072	15.33	AX-6508HW4	14.5	AX100177	15.27	AX100347	15.38
70102419	16.6	A0407073	15.33	AX-6512HW4	14.5	AX100178	15.27	AX100348	15.38
70102420	16.6	A0407074	15.33	AX-6516	14.5	AX100179	15.27	AX100349	15.38
70102447	16.6	A0408829	16.4	AX-6516GIG	14.5	AX100180	15.27	AX100350	15.38
A0266827	15.13	A0408835	16.4	AX-6524	14.5	AX100181	15.27	AX100351	15.38
A0266828	15.13	A0409651	15.33	AX-6524GIG	14.5	AX100182	15.39	AX100352	15.38
A0269923	15.13	A0409652	15.33	AX-8201	14.3	AX100183	15.39	AX100353	15.38
A0269925	15.13	A0409653	15.33	AX-8202	14.3	AX100184	15.39	AX100354	15.38
A0270164	15.14	A0409654	15.33	AX-8205	14.3	AX100185	15.39	AX100355	15.38
A0270165	15.17	A0410469	15.16	AX-8206	14.3	AX100186	15.39	AX100356	15.38
A0270166	15.17	A0410471	15.16	AX-8210	14.3	AX100187	15.39	AX100357	15.38
A0270168	15.14	A0410473	15.16	AX-8210-RM	14.3	AX100188	15.39	AX100382	15.38
A0270169	15.17	A0410475	15.16	AX-8210-WM	14.3	AX100189	15.39	AX100383	15.38
A0270172	15.17	A0410493	15.16	AX-8220	14.3	AX100190	15.39	AX100384	15.38
A0275511	15.15	A0410494	15.16	AX-8300	14.3	AX100191	15.39	AX100385	15.38
A0275512	15.15	A0410495	15.16	AX-8300AXIS205	14.3	AX100192	15.39	AX100386	15.38
A0276394	15.14	A0410496	15.16	AX-8300AXIS2120	14.3	AX100193	15.39	AX100387	15.38
A0276396	15.14	A0410497	15.16	AX-8300HW	14.3	AX100194	15.39	AX100388	15.38
A0277853	15.14	A0620806	15.31	AX-8300IVC100	14.3	AX100195	15.39	AX100389	15.38
A0277854	15.14	A0620807	15.31	AX-8300SNCRZ30N	14.3	AX100196	15.39	AX100390	15.38
A0284798	15.14	A0620808	15.31	AX-8300SR600101	14.3	AX100197	15.39	AX100391	15.38
A0285986	15.14	A0620809	15.31	AX-8310	14.3	AX100198	15.39	AX100392	15.38
A0316446	16.14	A0643205	15.36, 16.16	AX-8320	14.3	AX100199	15.39	AX100393	15.38
A0318897	15.15	A0643206	15.36, 16.16	AX-8351	14.4	AX100200	15.39	AX100394	15.38
A0318904	16.14	A0643207	15.36, 16.16	AX-8351HW	14.4	AX100201	15.39	AX100395	15.38
A0321775	15.15	A0643208	15.36, 16.16	AX-8400	14.3	AX100202	15.39	AX100396	15.38
A0321776	15.15	A0644488	12.7	AX-8400IQEYE3	14.3	AX100203	15.39	AX100397	15.38
A0325091	15.17	A0644489	12.7	AX-8400M58305AP	14.3	AX100204	15.39	AX100398	15.38
A0325493	15.17	A0644490	12.7	AX-8400MXD03	14.3	AX100205	15.39	AX100399	15.38
A0327325	15.15	A0644492	12.7	AX-8400SP400101	14.3	AX100206	15.39	AX100400	15.38
A0327326	15.15	A0644497	12.6	AX-8410	14.3	AX100207	15.39	AX100401	15.38
A0330863	15.13	A0644499	12.6	AX-8420	14.3	AX100208	15.39	AX100402	15.38
A0330864	15.13	A0645267	15.31	AX-8451	14.4	AX100209	15.39	AX100403	15.38
A0335015	16.14	A0645268	15.31	AX-8500	14.3	AX100210	15.39	AX100404	15.38
A0340836	15.14	A0645269	15.31	AX-8500HW	14.3	AX100211	15.39	AX100405	15.38
A0340837	15.15	A0645270	15.31	AX-8510	14.3	AX100212	15.39	AX100435	15.24
A0340838	15.14	A0645271	15.33	AX-8520	14.3	AX100213	15.39	AX100436	15.24
A0341173	15.13	A0645272	15.33	AX-8551	14.4	AX100214	15.39	AX100437	15.24
A0352331	15.17	A0645273	15.33	AX-8551HW	14.4	AX100219	15.36, 16.16	AX100438	15.24
A0390851	16.5	A0645274	15.33	AX-8600	14.3	AX100220	15.36, 16.16	AX100439	15.24
A0393146	15.13	A0649254	15.37, 16.16	AX-8600HW	14.3	AX100221	15.36, 16.16	AX100440	15.24
A0394328	16.14	A0649869	16.14	AX-8610	14.3	AX100222	15.36, 16.16	AX100441	15.24
A0394330	16.14	AC200004	16.8	AX-8620	14.3	AX100223	15.36	AX100442	15.24
A0394331	16.14	AX-50	15.44, 16.17	AX-8651	14.4	AX100224	15.36	AX100443	15.24
A0396695	12.7	AX-50R	15.44, 16.17	AX-8651HW	14.4	AX100226	15.45	AX100444	15.24
A0403634	16.4	AX-70	15.44, 16.17	AX-8858-01	14.6	AX100248	12.7	AX100445	15.24
A0403641	16.4	AX-80	15.44, 16.17	AX-8858-02	14.6	AX100249	12.7	AX100452	15.23
A0403977	12.7	AX-110BT	15.44, 16.17	AX100029	16.4	AX100281	15.24	AX100454	15.23
A0405255	15.31	AX-200	15.44, 16.17	AX100041	16.12	AX100282	15.24	AX100458	15.24
A0405256	15.31	AX-270	15.44, 16.17	AX100042	16.12	AX100283	15.24	AX100461	15.24
A0405257	15.31	AX-270P4U	15.44, 16.17	AX100045	16.13	AX100284	15.24	AX100462	12.7
A0405258	15.31	AX-270P8U	15.44, 16.17	AX100046	16.13	AX100304	15.33	AX100463	12.7
A0405294	15.31	AX-280	15.44, 16.17	AX100047	16.13	AX100305	15.33	AX100464	15.23
A0405295	15.31	AX-509	15.44, 16.17	AX100066	16.14	AX100306	15.33	AX100465	15.23
A0405296	15.31	AX-820-04	14.6	AX100068	16.12	AX100307	15.33	AX100472	15.23
A0405298	15.31	AX-820Y-01	14.6	AX100069	16.12	AX100308	15.33	AX100473	15.23
A0405536	15.39	AX-820Y-02	14.6	AX100073	16.13	AX100309	15.33	AX100491	15.24
A0405537	15.39	AX-820Y-03	14.6	AX100074	16.13	AX100310	15.33	AX100494	15.36
A0405538	15.39	AX-820Y-05	14.6	AX100077	16.12	AX100311	15.33	AX100495	16.13
A0405539	15.39	AX-820Y-06	14.6	AX100078	16.12	AX100328	16.8	AX100496	16.13
A0406995	15.37	AX-820Y-07	14.6	AX100079	16.14	AX100329	16.8	AX100505	15.23
A0406996	15.37	AX-820Y-08	14.6	AX100080	16.14	AX100330	16.8	AX100506	15.23
A0406997	15.37	AX-820Y-09	14.6	AX100082	16.14	AX100331	16.8	AX100528	16.14
A0406998	15.37	AX-1912-MCR	15.44, 16.17	AX100084	16.14	AX100332	16.8	AX100530	16.14
A0406999	15.37	AX-5270SC	15.44, 16.17	AX100088	16.14	AX100334	15.38	AX100532	16.14
A0407000	15.37	AX-5270ST	15.44, 16.17	AX100090	16.14	AX100335	15.38	AX100534	16.14
A0407001	15.37	AX-6108	14.5	AX100092	16.14	AX100336	15.38	AX100536	16.14
A0407002	15.37	AX-6108-RM	14.5	AX100094	16.14	AX100337	15.38	AX100538	16.14
A0407003	15.37, 16.16	AX-6201	14.5	AX100098	16.14	AX100338	15.38	AX100540	16.13
A0407004	15.37, 16.16	AX-6208	14.5	AX100115	16.12	AX100339	15.38	AX100541	16.13
A0407005	15.37, 16.16	AX-6224	14.5	AX100116	16.12	AX100340	15.38	AX100542	16.13
A0407006	15.37, 16.16	AX-6500	14.5	AX100171	15.27	AX100341	15.38	AX100543	16.13
A0407007	15.37, 16.16	AX-6500GIG	14.5	AX100172	15.27	AX100342	15.38	AX100577	15.27
A0407008	15.37, 16.16	AX-6500HW4	14.5	AX100173	15.27	AX100343	15.38	AX100578	15.27
A0407009	15.37, 16.16	AX-6504HW4	14.5	AX100174	15.27	AX100344	15.38	AX100579	15.27
A0407010	15.37, 16.16	AX-6508	14.5	AX100175	15.27	AX100345	15.38	AX100580	15.27
A0407071	15.33	AX-6508GIG	14.5	AX100176	15.27	AX100346	15.38	AX100581	15.27

Index

Part Numbers

How To Use This Index: All part numbers beginning with a number are listed in numerical sequence; any alpha characters within the part number are ignored for sequencing purposes. All part numbers beginning with an alpha character follow behind the numerical listings in an alpha/numeric sequence. Also use the e-catalog on www.belden.com for part number searches.

Part No.	Page	Part No.	Page	Part No.	Page	Part No.	Page	Part No.	Page
AX100582	15.27	AX100704	15.19	AX101071	15.25	AX101327	15.25	AX101538	15.21
AX100583	15.27	AX100705	15.19	AX101072	15.25	AX101328	15.25	AX101539	15.21
AX100584	15.27	AX100706	15.19	AX101073	15.25	AX101340	15.25	AX101540	15.21
AX100585	15.27	AX100707	15.18	AX101075	16.4	AX101341	15.25	AX101541	15.21
AX100586	15.27	AX100708	15.18	AX101077	16.4	AX101342	15.25	AX101542	15.21
AX100587	15.27	AX100709	15.20	AX101084	16.11	AX101343	15.25	AX101543	15.21
AX100588	15.27	AX100710	15.20	AX101085	16.11	AX101344	15.25	AX101544	15.21
AX100589	15.27	AX100711	15.20	AX101089	16.11	AX101345	15.25	AX101545	15.21
AX100590	15.27	AX100721	15.19	AX101090	16.11	AX101346	15.25	AX101546	15.21
AX100591	15.27	AX100749	15.40	AX101091	16.11	AX101347	15.25	AX101547	15.21
AX100592	15.27	AX100781	12.10	AX101092	16.11	AX101348	15.25	AX101548	15.21
AX100593	15.27	AX100783	12.10	AX101093	15.24	AX101349	15.25	AX101549	15.21
AX100594	15.27	AX100784	12.10	AX101094	15.24	AX101350	15.25	AX101550	15.21
AX100595	15.27	AX100785	12.5	AX101095	15.24	AX101366	16.6	AX101551	15.21
AX100596	15.27	AX100786	12.5	AX101096	16.11	AX101367	16.6	AX101552	15.21
AX100597	15.27	AX100788	12.7	AX101098	16.14	AX101368	16.6	AX101553	15.21
AX100598	15.27	AX100789	12.7	AX101100	16.14	AX101371	12.4	AX101554	15.21
AX100599	15.24	AX100792	12.7	AX101101	16.14	AX101372	15.35	AX101555	15.21
AX100601	15.38	AX100793	12.7	AX101114	16.11	AX101373	15.35	AX101556	15.21
AX100602	15.38	AX100794	12.7	AX101115	16.14	AX101374	15.35	AX101557	15.21
AX100604	15.38	AX100795	12.7	AX101117	16.14	AX101375	15.35	AX101558	15.21
AX100605	15.38	AX100796	12.7	AX101119	16.11	AX101376	15.35	AX101559	15.21
AX100613	15.38	AX100797	12.7	AX101120	16.11	AX101377	15.35	AX101560	15.21
AX100614	15.38	AX100798	15.13	AX101122	16.6	AX101407	16.14	AX101561	15.21
AX100615	15.38	AX100826	15.45	AX101123	16.6	AX101409	16.14	AX101562	15.21
AX100616	15.38	AX100827	15.45	AX101125	16.6	AX101411	16.5	AX101563	15.21
AX100640	15.38	AX100910	16.4	AX101128	16.6	AX101412	16.5	AX101564	15.21
AX100641	15.38	AX100919	16.5	AX101133	16.6	AX101413	15.35	AX101565	15.21
AX100642	15.38	AX100925	15.33	AX101137	16.6	AX101414	15.35	AX101566	15.21
AX100643	15.38	AX100926	15.33	AX101138	16.6	AX101415	15.35	AX101567	15.21
AX100645	15.27	AX100927	15.33	AX101139	16.6	AX101416	15.35	AX101568	15.21
AX100646	15.27	AX100928	15.33	AX101143	16.6	AX101431	15.32	AX101569	15.21
AX100647	15.27	AX100929	16.5	AX101151	16.6	AX101432	15.32	AX101571	15.23
AX100648	15.27	AX100930	12.3	AX101155	16.6	AX101433	15.32	AX101573	15.23
AX100649	15.27	AX100931	12.3	AX101156	16.6	AX101434	15.32	AX101581	16.11
AX100650	15.27	AX100932	12.4	AX101157	16.6	AX101435	15.32	AX101584	15.21
AX100651	15.27	AX100933	12.4	AX101161	16.6	AX101436	15.32	AX101611	15.22
AX100652	15.27	AX100934	16.11	AX101166	16.6	AX101437	15.32	AX101612	15.22
AX100653	15.27	AX100935	16.11	AX101173	12.7	AX101438	15.32	AX101613	15.22
AX100654	15.27	AX100936	16.11	AX101174	12.3	AX101439	15.32	AX101614	15.22
AX100655	15.27	AX100937	16.11	AX101175	12.3	AX101440	15.32	AX101626	15.21
AX100667	15.27	AX100943	16.11	AX101176	12.3	AX101441	15.32	AX101713	16.11
AX100668	15.27	AX100944	16.11	AX101177	12.3	AX101442	15.32	AX101714	16.11
AX100669	15.27	AX100945	16.14	AX101178	12.3	AX101447	15.9	AX101715	16.11
AX100670	15.27	AX100947	16.4	AX101179	12.3	AX101448	15.9	AX101729	16.14
AX100671	15.27	AX100949	16.4	AX101180	12.4	AX101456	15.23	AX101731	16.14
AX100672	15.27	AX100951	16.4	AX101181	12.4	AX101458	15.23	AX101741	16.14
AX100673	15.27	AX101033	15.26	AX101182	12.4	AX101466	15.37, 16.16	AX101743	16.14
AX100674	15.27	AX101034	15.26	AX101183	12.4	AX101467	15.37, 16.16	AX101745	15.28, 16.15
AX100675	15.27	AX101035	15.26	AX101184	12.4	AX101468	15.11	AX101746	15.28, 16.15
AX100676	15.27	AX101036	15.26	AX101185	15.40	AX101469	15.11	AX101747	15.28, 16.15
AX100677	15.27	AX101037	15.26	AX101186	16.11	AX101470	15.9	AX101748	15.28, 16.15
AX100678	15.27	AX101038	15.26	AX101187	16.11	AX101471	15.9	AX101749	15.29, 16.15
AX100679	15.27	AX101039	15.26	AX101188	16.11	AX101472	15.9	AX101750	15.29, 16.15
AX100680	15.27	AX101040	15.26	AX101189	16.11	AX101474	15.32	AX101751	15.29, 16.15
AX100681	15.27	AX101041	15.26	AX101190	16.11	AX101475	15.32	AX101752	15.29, 16.15
AX100682	15.27	AX101042	15.26	AX101254	12.3	AX101476	15.32	AX101753	15.29, 16.15
AX100683	15.27	AX101043	15.26	AX101307	15.26	AX101477	15.32	AX101754	15.29, 16.15
AX100684	15.27	AX101044	15.26	AX101308	15.26	AX101478	15.11	AX101755	15.29, 16.15
AX100685	15.27	AX101045	15.26	AX101309	15.26	AX101483	15.9	AX101756	15.29, 16.15
AX100686	15.27	AX101046	15.26	AX101310	15.26	AX101486	15.9	AX101757	15.29
AX100687	15.27	AX101047	15.26	AX101311	15.26	AX101520	15.11	AX101758	15.29
AX100688	15.27	AX101048	15.26	AX101312	15.26	AX101521	15.11	AX101759	15.29
AX100690	15.18	AX101049	15.26	AX101313	15.26	AX101524	16.11	AX101760	15.29
AX100691	15.18	AX101050	15.26	AX101314	15.26	AX101525	16.11	AX101761	15.29
AX100692	15.18	AX101051	15.26	AX101315	15.26	AX101526	16.11	AX101762	15.29
AX100693	15.18	AX101052	15.26	AX101316	15.26	AX101527	16.11	AX101763	15.29
AX100694	15.18	AX101053	15.26	AX101317	15.26	AX101528	16.11	AX101764	15.29
AX100695	15.18	AX101054	15.26	AX101318	15.25	AX101529	16.11	AX101765	15.29
AX100696	15.18	AX101063	15.25	AX101319	15.25	AX101530	16.11	AX101766	15.29
AX100697	15.18	AX101064	15.25	AX101320	15.25	AX101531	16.11	AX101767	15.29
AX100698	15.18	AX101065	15.25	AX101321	15.25	AX101532	15.21	AX101768	15.29
AX100699	15.18	AX101066	15.25	AX101322	15.25	AX101533	15.21	AX101769	15.29
AX100700	15.18	AX101067	15.25	AX101323	15.25	AX101534	15.21	AX101770	15.29
AX100701	15.19	AX101068	15.25	AX101324	15.25	AX101535	15.21	AX101771	15.29
AX100702	15.19	AX101069	15.25	AX101325	15.25	AX101536	15.21	AX101772	15.29
AX100703	15.19	AX101070	15.25	AX101326	15.25	AX101537	15.21	AX101773	15.30



Index

Part Numbers

How To Use This Index: All part numbers beginning with a number are listed in numerical sequence; any alpha characters within the part number are ignored for sequencing purposes. All part numbers beginning with an alpha character follow behind the numerical listings in an alpha/numeric sequence. Also use the e-catalog on www.belden.com for part number searches.

Part No.	Page	Part No.	Page	Part No.	Page	Part No.	Page	Part No.	Page
AX101774	15.30	AX101942	15.30, 16.15	AX102093	16.10	AX102293	15.6	AX102609	15.28, 16.15
AX101775	15.30	AX101943	16.11	AX102094	16.10	AX102296	15.6	AX102610	13.3, 15.29, 16.15
AX101776	15.30	AX101944	16.11	AX102095	16.10	AX102305	16.11	AX102611	13.3
AX101777	15.30	AX101945	15.10	AX102096	16.10	AX102306	16.11	AX102612	15.29, 16.15
AX101778	15.28	AX101946	15.10	AX102097	16.10	AX102307	16.11	AX102613	15.29, 16.15
AX101779	15.28	AX101947	15.10	AX102098	16.10	AX102308	16.11	AX102614	15.29
AX101780	15.28	AX101948	15.10	AX102099	16.10	AX102309	16.11	AX102615	15.29
AX101781	15.28	AX101949	15.10	AX102100	16.10	AX102310	16.10	AX102616	15.30
AX101782	15.28	AX101950	15.10	AX102101	16.10	AX102311	16.10	AX102617	15.30
AX101783	15.28	AX101951	15.10	AX102102	16.10	AX102312	16.10	AX102618	15.30
AX101784	15.28	AX101952	15.10	AX102103	16.10	AX102313	16.10	AX102619	15.30, 15.37, 16.15
AX101785	15.28	AX101953	15.10	AX102104	16.10	AX102314	16.10	AX102620	15.30, 16.15
AX101786	15.28	AX101954	15.10	AX102105	16.10	AX102315	16.10	AX102621	15.28
AX101787	15.28	AX101955	15.10	AX102106	16.10	AX102334	15.30	AX102622	15.28
AX101788	15.28	AX101956	15.10	AX102107	16.10	AX102335	15.30	AX102623	15.28
AX101789	15.28	AX101957	15.10	AX102108	16.10	AX102336	15.30	AX102624	15.37
AX101790	15.30	AX101958	15.10	AX102109	16.10	AX102337	15.30	AX102625	15.37
AX101791	16.4	AX101959	15.10	AX102110	16.10	AX102480	15.29, 16.15	AX102626	15.37
AX101792	16.4	AX101960	15.10	AX102111	16.10	AX102481	15.29, 16.15	AX102627	15.37
AX101793	16.4	AX101961	15.10	AX102112	16.10	AX102482	15.29, 16.15	AX102628	15.37
AX101794	16.4	AX101962	15.10	AX102113	16.10	AX102483	15.29, 16.15	AX102630	15.30
AX101797	16.13	AX101963	15.10	AX102114	16.10	AX102484	15.29, 16.15	AX102648	15.33
AX101798	16.13	AX101964	15.10	AX102115	16.10	AX102485	15.29, 16.15	AX102649	15.30, 16.15
AX101799	16.13	AX101965	15.10	AX102116	16.10	AX102488	15.6	AX102650	15.30, 16.15
AX101800	16.13	AX101966	15.10	AX102117	16.10	AX102512	12.10	AX200056	16.6
AX101801	16.13	AX101967	15.10	AX102118	16.10	AX102513	12.10	AX200057	16.6
AX101802	16.13	AX101968	15.10	AX102119	16.10	AX102514	12.5	AX200058	16.6
AX101820	15.21	AX101969	15.10	AX102120	16.10	AX102515	12.10	AX200060	16.6
AX101821	15.21	AX101970	15.10	AX102121	16.10	AX102516	12.10	AX200082	16.6
AX101823	15.37	AX101971	15.10	AX102122	16.10	AX102517	12.10	AX200084	16.6
AX101824	15.37	AX101972	15.10	AX102123	16.10	AX102562	15.6	AX200090	16.6
AX101825	15.37	AX101973	15.10	AX102124	16.10	AX102563	15.25	AX200091	16.6
AX101826	15.37	AX101974	15.10	AX102125	16.10	AX102564	15.26	AX200092	16.6
AX101827	15.37	AX101975	15.10	AX102126	16.10	AX102565	15.26	AX200094	16.6
AX101828	15.37	AX101976	15.10	AX102127	16.10	AX102566	15.28	AX200095	16.6
AX101829	15.37	AX101977	15.10	AX102128	16.10	AX102567	15.28	AX200096	16.6
AX101830	15.37	AX101978	15.10	AX102129	16.10	AX102568	15.28	AX200097	16.6
AX101831	15.37	AX101979	15.10	AX102130	16.10	AX102569	15.28, 16.15	AX200098	16.6
AX101832	15.37	AX101980	15.10	AX102145	15.12	AX102570	15.28, 16.15	AX200192	16.6
AX101833	15.37	AX101981	16.4	AX102146	15.11	AX102571	15.29, 16.15	AX200196	16.6
AX101834	15.37	AX101982	16.4	AX102147	15.11	AX102572	15.29, 16.15	AX200280	16.6
AX101835	15.37	AX101983	16.4	AX102148	15.11	AX102573	15.29, 16.15	AX200341	16.6
AX101836	15.37	AX101984	16.4	AX102149	15.11	AX102574	15.29	AX200413	16.6
AX101837	15.37	AX101985	15.9	AX102150	15.11	AX102575	15.29	AX200421	16.6
AX101838	15.37	AX101986	15.9	AX102151	15.11	AX102576	15.29	AX200458	16.6
AX101839	15.37	AX101987	15.9	AX102152	15.11	AX102577	15.29	AX200459	16.6
AX101840	15.37	AX102005	15.34	AX102153	15.11	AX102578	15.30	AX200507	16.6
AX101841	15.37	AX102006	15.34	AX102154	15.11	AX102579	15.30	AX200508	16.6
AX101842	15.37	AX102007	15.34	AX102155	15.11	AX102580	15.30	AX200509	16.6
AX101852	15.40	AX102008	15.34	AX102156	15.11	AX102581	15.30	AX200517	16.6
AX101869	15.28, 16.15	AX102009	15.34	AX102197	16.9	AX102582	15.32	AX200518	16.6
AX101870	15.28, 16.15	AX102010	15.34	AX102198	16.9	AX102583	15.32	AX200519	16.6
AX101871	15.28, 16.15	AX102011	15.34	AX102199	16.9	AX102584	15.32	AX200527	16.6
AX101872	15.28, 16.15	AX102012	15.34	AX102200	16.9	AX102585	15.31	AX200528	16.6
AX101873	15.29, 16.15	AX102013	15.34	AX102201	16.9	AX102586	15.31	AX200529	16.6
AX101874	15.29, 16.15	AX102014	15.39	AX102202	16.9	AX102587	15.31	AX200580	16.6
AX101875	15.29, 16.15	AX102015	15.39	AX102203	16.9	AX102588	15.31	AX200581	16.6
AX101876	15.29, 16.15	AX102016	15.39	AX102204	16.9	AX102589	15.32	AX200589	16.6
AX101877	15.30	AX102017	15.39	AX102205	16.9	AX102590	15.33	AX200603	16.6
AX101878	15.30	AX102018	15.39	AX102206	16.9	AX102591	15.33	AX200624	16.6
AX101879	15.30	AX102019	15.39	AX102207	16.9	AX102592	15.33	AX200653	16.6
AX101880	15.30	AX102020	15.39	AX102208	16.9	AX102593	15.33	AX200657	16.6
AX101881	15.30	AX102021	15.39	AX102209	15.37, 16.16	AX102594	15.33	AX200658	16.6
AX101882	15.30	AX102022	15.39	AX102210	15.37, 16.16	AX102595	15.36	AX200659	16.6
AX101883	15.30	AX102023	15.39	AX102211	15.37, 16.16	AX102596	15.37	AX200660	16.6
AX101884	15.30	AX102024	15.39	AX102212	16.16	AX102597	15.37	AX200664	16.6
AX101885	15.30	AX102032	16.11	AX102213	15.37, 16.16	AX102598	15.37	AX200665	16.6
AX101886	15.30	AX102033	16.11	AX102214	15.37, 16.16	AX102599	15.37	AX200666	16.6
AX101887	15.30	AX102061	16.4	AX102215	15.37, 16.16	AX102600	15.39	AX200667	16.6
AX101888	15.30	AX102062	16.4	AX102216	15.37, 16.16	AX102601	15.37	AX200668	16.6
AX101935	15.30, 16.15	AX102063	16.4	AX102269	15.6	AX102602	15.37	AX200695	16.6
AX101936	15.30, 16.15	AX102073	15.12	AX102271	15.6	AX102603	15.37	AX200698	16.6
AX101937	15.30, 16.15	AX102082	15.12	AX102272	15.6	AX102604	15.37	AX200699	16.6
AX101938	15.30, 16.15	AX102089	16.10	AX102274	15.6	AX102605	15.37	AX200795	16.6
AX101939	15.30, 16.15	AX102090	16.10	AX102275	15.6	AX102606	15.39	AX200797	16.6
AX101940	15.30, 16.15	AX102091	16.10	AX102276	15.6	AX102607	15.39	AX200799	16.6
AX101941	15.30, 16.15	AX102092	16.10	AX102277	15.6	AX102608	15.28, 16.15	AX200800	16.6



Index

Part Numbers

How To Use This Index: All part numbers beginning with a number are listed in numerical sequence; any alpha characters within the part number are ignored for sequencing purposes. All part numbers beginning with an alpha character follow behind the numerical listings in an alpha/numeric sequence. Also use the e-catalog on www.belden.com for part number searches.

Part No.	Page	Part No.	Page	Part No.	Page	Part No.	Page	Part No.	Page
AX200801	16.6	AX201434	16.9	AX201511	16.9	AX300010	15.20	AX350023	15.42
AX200802	16.6	AX201435	16.9	AX201512	16.9	AX300011	15.20	AX350024	15.42
AX200803	16.6	AX201436	16.9	AX201513	16.9	AX300012	15.20	AX350025	15.42
AX200809	16.6	AX201437	16.9	AX201514	16.9	AX300013	15.20	AX350026	15.42
AX200810	16.6	AX201438	16.9	AX201515	16.9	AX300014	15.20	AX350027	15.42
AX200811	16.6	AX201439	16.9	AX201516	16.9	AX300015	15.20	AX350028	15.42
AX200812	16.6	AX201440	16.9	AX201517	16.9	AX300017	15.20	AX350029	15.42
AX200900	16.6	AX201441	16.9	AX201518	16.9	AX300021	15.20	AX350030	15.42
AX201365	16.9	AX201442	16.9	AX201519	16.9	AX300025	15.20	AX350031	15.42
AX201366	16.9	AX201443	16.9	AX201520	16.9	AX300026	15.20	AX350032	15.42
AX201367	16.9	AX201444	16.9	AX201521	16.9	AX300027	15.20	AX350033	15.42
AX201368	16.9	AX201445	16.9	AX201522	16.9	AX300029	15.20	AX350034	15.42
AX201369	16.9	AX201446	16.9	AX201523	16.9	AX300030	15.20	AX350035	15.42
AX201370	16.9	AX201447	16.9	AX201524	16.9	AX300032	15.20	AX350036	15.42
AX201371	16.9	AX201448	16.9	AX201525	16.9	AX300034	15.20	AX350037	15.41
AX201372	16.9	AX201449	16.9	AX201526	16.9	AX300037	15.20	AX350038	15.41
AX201373	16.9	AX201450	16.9	AX201527	16.9	AX300038	15.20	AX350039	15.41
AX201374	16.9	AX201451	16.9	AX201528	16.9	AX300039	15.20	AX350040	15.41
AX201375	16.9	AX201452	16.9	AX201529	16.9	AX300040	15.20	AX350041	15.41
AX201376	16.9	AX201453	16.9	AX201530	16.9	AX330013	15.42	AX350042	15.41
AX201377	16.9	AX201454	16.9	AX201531	16.9	AX330014	15.42	AX350043	15.41
AX201378	16.9	AX201455	16.9	AX201532	16.9	AX330015	15.42	AX350044	15.41
AX201379	16.9	AX201456	16.9	AX201533	16.9	AX330016	15.42	AX350045	15.41
AX201380	16.9	AX201457	16.9	AX201534	16.9	AX330017	15.42	AX350046	15.41
AX201381	16.9	AX201458	16.9	AX201535	16.9	AX330018	15.42	AX350047	15.41
AX201382	16.9	AX201459	16.9	AX201536	16.9	AX330019	15.42	AX350048	15.41
AX201383	16.9	AX201460	16.9	AX201537	16.9	AX330020	15.42	AX350049	15.41
AX201384	16.9	AX201461	16.9	AX201538	16.9	AX330021	15.42	AX350050	15.41
AX201385	16.9	AX201462	16.9	AX201539	16.9	AX330022	15.42	AX350051	15.41
AX201386	16.9	AX201463	16.9	AX201540	16.9	AX330023	15.42	AX350052	15.41
AX201387	16.9	AX201464	16.9	AX201541	16.9	AX330024	15.42	AX350053	15.41
AX201388	16.9	AX201465	16.9	AX201542	16.9	AX330025	15.42	AX350054	15.41
AX201389	16.9	AX201466	16.9	AX201543	16.9	AX330026	15.42	AX350055	15.41
AX201390	16.9	AX201467	16.9	AX201544	16.9	AX330027	15.42	AX350056	15.41
AX201391	16.9	AX201468	16.9	AX250001	16.8	AX330028	15.42	AX350057	15.41
AX201392	16.9	AX201469	16.9	AX250005	16.8	AX330029	15.42	AX350058	15.41
AX201393	16.9	AX201470	16.9	AX250009	16.8	AX330030	15.42	AX350059	15.41
AX201394	16.9	AX201471	16.9	AX250011	16.8	AX330043	15.42	AX350060	15.41
AX201395	16.9	AX201472	16.9	AX250021	16.7	AX330044	15.42	AX350061	15.41
AX201396	16.9	AX201473	16.9	AX250052	16.8	AX330045	15.42	AX350062	15.41
AX201397	16.9	AX201474	16.9	AX250054	16.8	AX330046	15.42	AX350063	15.41
AX201398	16.9	AX201475	16.9	AX250060	16.7	AX330047	15.42	AX350064	15.41
AX201399	16.9	AX201476	16.9	AX250061	16.7	AX330048	15.42	AX350065	15.41
AX201400	16.9	AX201477	16.9	AX250065	16.7	AX330049	15.42	AX350066	15.41
AX201401	16.9	AX201478	16.9	AX250066	16.7	AX330050	15.42	AX350067	15.41
AX201402	16.9	AX201479	16.9	AX250067	16.7	AX330051	15.42	AX350068	15.41
AX201403	16.9	AX201480	16.9	AX250071	16.7	AX330052	15.42	AX350069	15.41
AX201404	16.9	AX201481	16.9	AX250072	16.7	AX330053	15.42	AX350070	15.41
AX201405	16.9	AX201482	16.9	AX250073	16.7	AX330054	15.42	AX350071	15.41
AX201406	16.9	AX201483	16.9	AX250105	16.7	AX330055	15.42	AX350072	15.41
AX201407	16.9	AX201484	16.9	AX250106	16.7	AX330056	15.42	AX350160	15.41
AX201408	16.9	AX201485	16.9	AX250178	16.8	AX330057	15.42	AX350161	15.41
AX201409	16.9	AX201486	16.9	AX250179	16.8	AX330058	15.42	AX350162	15.41
AX201410	16.9	AX201487	16.9	AX250180	16.8	AX330059	15.42	AX350163	15.41
AX201411	16.9	AX201488	16.9	AX250224	16.7	AX330060	15.42	AX360015	15.7
AX201412	16.9	AX201489	16.9	AX250345	16.7	AX350001	15.42	AX360016	15.7
AX201413	16.9	AX201490	16.9	AX250349	16.7	AX350002	15.42	AX360017	15.7
AX201414	16.9	AX201491	16.9	AX250376	16.7	AX350003	15.42	AX360018	15.7
AX201415	16.9	AX201492	16.9	AX250387	16.7	AX350004	15.42	AX360021	15.7
AX201416	16.9	AX201493	16.9	AX250412	16.7	AX350005	15.42	AX360022	15.7
AX201417	16.9	AX201494	16.9	AX250413	16.7	AX350006	15.42	AX360023	15.7
AX201418	16.9	AX201495	16.9	AX250457	16.7	AX350007	15.42	AX360024	15.7
AX201419	16.9	AX201496	16.9	AX250458	16.7	AX350008	15.42	AX360027	15.7
AX201420	16.9	AX201497	16.9	AX250459	16.8	AX350009	15.42	AX360028	15.7
AX201421	16.9	AX201498	16.9	AX250460	16.8	AX350010	15.42	AX360029	15.7
AX201422	16.9	AX201499	16.9	AX250461	16.8	AX350011	15.42	AX360030	15.7
AX201423	16.9	AX201500	16.9	AX250539	16.8	AX350012	15.42	AX360045	15.7
AX201424	16.9	AX201501	16.9	AX250540	16.8	AX350013	15.42	AX360046	15.7
AX201425	16.9	AX201502	16.9	AX250541	16.8	AX350014	15.42	AX360047	15.7
AX201426	16.9	AX201503	16.9	AX250542	16.8	AX350015	15.42	AX360048	15.7
AX201427	16.9	AX201504	16.9	AX300001	15.20	AX350016	15.42	AX360051	15.7
AX201428	16.9	AX201505	16.9	AX300002	15.20	AX350017	15.42	AX360052	15.7
AX201429	16.9	AX201506	16.9	AX300005	15.20	AX350018	15.42	AX360053	15.7
AX201430	16.9	AX201507	16.9	AX300006	15.20	AX350019	15.42	AX360054	15.7
AX201431	16.9	AX201508	16.9	AX300007	15.20	AX350020	15.42	AX360057	15.7
AX201432	16.9	AX201509	16.9	AX300008	15.20	AX350021	15.42	AX360058	15.7
AX201433	16.9	AX201510	16.9	AX300009	15.20	AX350022	15.42	AX360059	15.7



Index

Part Numbers

How To Use This Index: All part numbers beginning with a number are listed in numerical sequence; any alpha characters within the part number are ignored for sequencing purposes. All part numbers beginning with an alpha character follow behind the numerical listings in an alpha/numeric sequence. Also use the e-catalog on www.belden.com for part number searches.

Part No.	Page	Part No.	Page	Part No.	Page	Part No.	Page	Part No.	Page
AX360060	15.7	B7801-SP-C	11.5, 11.8, 11.11	B9210-2923	11.21	BDR-7223	12.3	BWM-2406-GD-C	11.28
AX360265	15.7	B7802-SP-C	11.5, 11.8, 11.11	B9211-2917	11.21	BDR-8401	12.3	BWM-2406-SD-C	11.28
AX360266	15.7	B7824-FR-C	11.11	B9212-2922	11.21	BDR-8403	12.3	BWM-2419	11.29
AX360267	15.7	B7824-GF-C	11.11	B9309-0100	11.20	BDR-8419	12.3	BWM-2420-GD-C	11.28
AX360268	15.7	B7824-PD-C	11.11	B9315-7200	11.14, 11.17	BDR-8419-4	12.3	BWM-2420-SD-C	11.28
AX360269	15.7	B7824-SF-C	11.11	B9318-0200	11.27	BDR-8423	12.3	BWM-2424-GD-C	11.28
AX360270	15.7	B7824-SPR-C	11.14	B9318-0300	11.27	BER-3UC	12.5	BWM-2424-SD-C	11.28
AX360271	15.7	B7824-SR-C	11.11	B9318-0400	11.27	BER-6UP	12.5	BWM-3601	11.29
AX360272	15.7	B7824-SVF-C	11.14	B9411-1602	11.25	BER-6X6	12.5	BWM-3606-GD-C	11.28
AX380014	15.41	B7824-VF-C	11.11	B9412-0801	11.25	BER-AS	12.5	BWM-3606-SD-C	11.28
AX380015	15.41	B7824-VR-C	11.11	B9413-0601	11.25	BFT-03SRW8	13.2	BWM-3619	11.29
AX380016	15.41	B7829-FR-C	11.5, 11.8	B9414-0602	11.25	BFT-05SRW8	13.2	BWM-3620-GD-C	11.28
AX380017	15.41	B7829-GF-C	11.5, 11.8	B9415-1601	11.25	BFT-09SRW8	13.2	BWM-3620-SD-C	11.28
AX380018	15.41	B7829-PD-C	11.5, 11.8	B9415-1602	11.25	BFT-3T03W	13.3	BWM-3624-GD-C	11.28
AX380026	15.41	B7829-SF-C	11.5, 11.8	B9415-1603	11.25	BFT-3T05W	13.3	BWM-3624-SD-C	11.28
AX380027	15.41	B7829-SR-C	11.5, 11.8	B9415-1606	11.25	BFT-3T09W	13.3	BWM-4801	11.29
AX380028	15.41	B7829-SR-C	11.5, 11.8	B9415-1607	11.25	BFT-4T03W	13.3	BWM-4806-GD-C	11.28
AX380029	15.41	B7829-VR-C	11.5, 11.8	B9415-1608	11.25	BFT-4T05W	13.3	BWM-4806-SD-C	11.28
AX380030	15.41	B7836-01-SP-C	11.14	B9415-1610	11.25	BFT-4T09W	13.3	BWM-4819	11.29
AX380050	15.41	B7836-02-SP-C	11.14	B9416-1001	11.25	BFT-9003W	13.3	BWM-4820-GD-C	11.28
AX380051	15.41	B8401-SP-C	11.5, 11.8, 11.11	B9418-0801	11.26	BFT-9005W	13.3	BWM-4820-SD-C	11.28
AX380052	15.41	B8402-SP-C	11.5, 11.8, 11.11	B9418-0802	11.26	BFT-9009W	13.3	BWM-4824-GD-C	11.28
AX380053	15.41	B8424-DSPR-C	11.17	B9418-1201	11.26	BFT-CE03W	13.3	BWM-4824-SD-C	11.28
AX380054	15.41	B8424-DSSR-C	11.17	B9418-2401	11.26	BFT-CE05W	13.3	BWM-4830-SD-3S0001	11.28
AX380056	15.41	B8424-DSVF-C	11.17	B9418-2402	11.26	BFT-CE09W	13.3	BWM-9312-1600	11.29
AX380057	15.41	B8424-DSVR-C	11.17	B9418-2403	11.26	BFT-EC03W	13.3	BWR-1219	12.5
AX380058	15.41	B8424-FR-C	11.11	B9418-2410	11.26	BFT-EC05W	13.3	BWR-3619-12	12.5
AX380059	15.41	B8424-GF-C	11.11	B9418-4801	11.26	BFT-EC09W	13.3	BWR-3619-18	12.5
AX380060	15.41	B8424-PD-C	11.11	B9418-7201	11.26	BFT-F003W	13.3	BWR-4819	12.5
B2418-TP-1-C	11.11	B8424-SF-C	11.11	B9420-1905	11.24	BFT-F005W	13.3	BWR-4819-12	12.5
B2418-TP-2-C	11.11	B8424-SPR-C	11.14	B9420-1906	11.24	BFT-F009W	13.3	BWR-4819-18	12.5
B2418-TP-3-C	11.11	B8424-SR-C	11.11	B9510-1901	12.6	BFT-IN03W	13.3	C0039222	15.17
B2418-TP-4-C	11.11	B8424-SVF-C	11.14	B9511-1902	12.6	BFT-IN05W	13.3	C0054642	15.17
B2430-TP-1-C	11.14, 11.17	B8424-VF-C	11.11	B9512-1901	12.6	BFT-IN09W	13.3	C5500	18.89
B2430-TP-3-C	11.14, 11.17	B8424-VR-C	11.11	B9512-1902	12.6	BFT-OC03W	13.3	C5501	18.89
B2430-TP-4-C	11.14, 11.17	B8429-FR-C	11.5, 11.8	B9512-1902-FR	12.6	BFT-OC05W	13.3	C5502	18.89
B2430-TP-6-C	11.14, 11.17	B8429-GF-C	11.5, 11.8	B9513-1902	12.6	BFT-OC09W	13.3	C5503	18.89
B2918-TP-1-C	11.5, 11.8	B8429-PD-C	11.5, 11.8	B9514-1901	12.6	BFT-SC03W	13.3	C5504	18.89
B2918-TP-2-C	11.5, 11.8	B8429-SF-C	11.5, 11.8	B9610-2301	12.6	BFT-SC05W	13.3	C5505	18.89
B2918-TP-3-C	11.5, 11.8	B8429-SR-C	11.5, 11.8	B9611-2302	12.6	BFT-SC09W	13.3	C5506	18.89
B2918-TP-4-C	11.5, 11.8	B8429-VF-C	11.5, 11.8	B9712-0100	11.24	BGS84-3-100000	11.19	C5508	18.89
B433-5114	11.17	B8429-VR-C	11.5, 11.8	B9712-0101	11.24	BGS84-3-112346	11.19	C5510	18.89
B433-5115-F	11.17	B8436-01-SP-C	11.14, 11.17	B9712-0102	11.24	BRL-3006-0300	11.23	C5513	18.89
B433-5115-R	11.17	B8436-01-SPP-C	11.17	B9712-0103	11.24	BRL-3012-0200	11.23	C5518	18.89
B433-5118	11.17	B8436-02-SP-C	11.14, 11.17	B9712-0106	11.24	BRL-3024-0100	11.23	C5523	18.89
B4801-SP-C	11.5, 11.11	B8436-02-SPP-C	11.17	B9712-0107	11.24	BSL/BST-ATD-0300-3	11.22	C5528	18.89
B4802-SP-C	11.5, 11.11	B8910-0100	11.22	B9712-0108	11.24	BSL7219	11.23	C5529	18.89
B4824-FR-C	11.11	B8911-0100	11.22	B9712-0109	11.24	BSL7219SQ-2	11.23	C5530	18.89
B4824-GF-C	11.11	B8912-0100	12.3	B9712-0109S	11.24	BSL7819	11.23	C5531	18.89
B4824-PD-C	11.11	B8912-0200-C	11.29	B9713-0200	11.24	BSL8419	11.23	C5532	18.89
B4824-SF-C	11.11	B8913-0100	11.22	B9713-0201	11.24	BSL84-3-100000	11.10	C5533	18.89
B4824-SR-C	11.11	B8914-0100	11.22	B9713-0202	11.24	BSL84-3-122226	11.10	C5534	18.89
B4824-VF-C	11.11	B8915-0100	11.22	B9714-0190	11.22	BSR-8419-24	12.4	C5535	18.89
B4824-VR-C	11.11	B9010-1924	11.20	B9714-0720	11.22	BSR-8419-28	12.4	C5536	18.89
B4829-FR-C	11.5	B9010-1924-Q	11.20	B9810-0100	12.6	BSR-8419-32	12.4	C5538	18.89
B4829-GF-C	11.5	B9010-1930	11.20	B9811-0200	12.6	BSR-8419-36	12.4	C5540	18.89
B4829-PD-C	11.5	B9010-1930-Q	11.20	B9812-0300	12.6	BSR-8423-24	12.4	C5543	18.89
B4829-SF-C	11.5	B9010-1936	11.20	B9813-0400	12.6	BSR-8423-28	12.4	C5548	18.89
B4829-SR-C	11.5	B9011-1912	11.20	B9910-0100	12.6	BSR-8423-32	12.4	C5553	18.89
B4829-VF-C	11.5	B9011-1918	11.20	B9911-0200	12.6	BSR-8423-36	12.4	C5558	18.89
B4829-VR-C	11.5	B9011-1918-16	11.20	B9912-0300	12.6	BST4819-23	11.23	C5560	18.90
B7201-SP-C	11.5, 11.8, 11.11	B9012-1918	11.20	B9913-0400	12.6	BST7219-23	11.23	C5561	18.90
B7202-SP-C	11.5, 11.8, 11.11	B9012-1918-16	11.20	B9914-0200	12.6	BST7819-23	11.23	C5562	18.90
B7224-FR-C	11.11	B9013-1930	11.20	B9915-0300	12.6	BST8419-23	11.23	C5563	18.90
B7224-GF-C	11.11	B9013-1936	11.20	B9916-0400	12.6	BST8419-23SQ	11.23	C5564	18.90
B7224-PD-C	11.11	B9014-1907	11.20	BCR-8419	12.4	BST84-3-100000	11.4	C5565	18.90
B7224-SF-C	11.11	B9015-1902	11.20	BCR-8419-10	12.4	BST84-3-122226	11.4	C5566	18.90
B7224-SR-C	11.11	B9015-1909	11.20	BDP7219-23	11.23	BST-ATD-0030-3	11.22	C5568	18.90
B7224-VF-C	11.11	B9015-1924	11.20	BDP7219-23SQ	11.23	BSW-0100	11.29	C5570	18.90
B7224-VR-C	11.11	B9016-1921	11.20	BDP7819-23	11.23	BSW-0200	11.29	C5573	18.90
B7229-FR-C	11.5, 11.8	B9016-1921-3	11.20	BDP8419-23	11.23	BSW-8419	11.29	C5578	18.90
B7229-GF-C	11.5, 11.8	B9017-0200	11.20	BDP84-3-100000	11.7	BUS84-3-100000	11.13	C5579	18.90
B7229-PD-C	11.5, 11.8	B9110-2324	11.21	BDP84-3-122226	11.7	BUS84-3-122226	11.13	C5580	18.90
B7229-SF-C	11.5, 11.8	B9111-2318	11.21	BDP-ATD-0200-3	11.22	BUS-ATD-0010-C	11.22	C5581	18.90, 18.92
B7229-SR-C	11.5, 11.8	B9112-2318	11.21	BDR-4819	12.3	BUSD84-3-100000	11.16	C5582	18.90, 18.92
B7229-VF-C	11.5, 11.8	B9113-2324	11.21	BDR-7201	12.3	BUSD84-3-122226	11.16	C5583	18.90, 18.92
B7229-VR-C	11.5, 11.8	B9114-2307	11.21	BDR-7219	12.3	BWM-2401	11.29	C5590	18.93



Index

Part Numbers

How To Use This Index: All part numbers beginning with a number are listed in numerical sequence; any alpha characters within the part number are ignored for sequencing purposes. All part numbers beginning with an alpha character follow behind the numerical listings in an alpha/numeric sequence. Also use the e-catalog on www.belden.com for part number searches.

Part No.	Page	Part No.	Page	Part No.	Page	Part No.	Page	Part No.	Page
C5591	18.93	M96551	10.9	M9*112	10.5	M9*616	10.5	M9*815	10.11
C5592	18.93	M96566	10.9	M9*114	10.5	M9*619	10.5	M9*816	10.11
C5601	18.93	M96567	10.9	M9*116	10.5	M9*620	10.5	M9*817	10.11
C5602	18.93	M96568	10.9	M9*120	10.5	M9*621	10.5	M9*820	10.14
C5611	18.93	M96569	10.9	M9*130	10.7	M9*622	10.5	M9*821	10.14
C5621	18.93	M96570	10.9	M9*131	10.7	M9*623	10.5	M9*822	10.14
C5622	18.93	M96571	10.9	M9*132	10.7	M9*630	10.10	M9*840	10.14
C5625	18.94	M96572	10.9	M9*133	10.7	M9*631	10.10	M9*841	10.14
C5626	18.94	M96573	10.9	M9*134	10.7	M9*632	10.10	M9*842	10.14
C5627	18.94	M96574	10.9	M9*135	10.7	M9*633	10.10	M9*843	10.14
C5635	18.94	M96575	10.9	M9*136	10.7	M9*634	10.10	M9*844	10.14
C5701	18.92	M96639	10.9	M9*137	10.7	M9*640	10.10	M9*845	10.14
C5702	18.92	M96780	10.5	M9*138	10.7	M9*641	10.10	M9*846	10.14
C5730	18.92	M96908	10.5	M9*150	10.15	M9*642	10.10	M9*847	10.14
C5731	18.92	M96909	10.5	M9*151	10.15	M9*643	10.10	M9*848	10.14
C5732	18.92	M96915	10.3	M9*152	10.15	M9*644	10.10	M9*849	10.14
C5760	18.92	M96919	10.3	M9*153	10.15	M9*700	10.17	M9*890	10.13
C5761	18.92	M96963	10.5	M9*154	10.15	M9*701	10.17	M9*891	10.13
C5762	18.92	M96992	10.5	M9*155	10.15	M9*702	10.17	M9*892	10.13
C6064	18.89	M97041	10.5	M9*170	10.15	M9*703	10.17	M9*893	10.13
CTH15120N	12.8	M97112	10.3	M9*171	10.15	M9*704	10.17	M9*894	10.13
CTH17P175N	12.9	M97174	10.5	M9*172	10.15	M9*705	10.17	M9*895	10.13
CTH21P175N	12.9	M97219	10.5	M9*173	10.15	M9*720	10.17	M9*896	10.13
CTH36P175N	12.9	M97411	10.5	M9*174	10.15	M9*721	10.17	M9*897	10.13
CTH48P175N	12.9	M97412	10.5	M9*175	10.15	M9*722	10.17	MX100154	16.8
CTI11P40BW	12.8	M98086	10.3	M9*202	10.12	M9*723	10.17	NOT0651	16.4
CTI11P40N	12.8			M9*204	10.12	M9*724	10.17	P0596540	15.15
CTI14P40BW	12.8			M9*205	10.12	M9*725	10.17	P0660798	15.17
CTI14P40N	12.8			M9*206	10.12	M9*740	10.17	PX101317	16.4
CTI5P40BW	12.8			M9*207	10.12	M9*741	10.17	PX101318	16.4
CTI5P40N	12.8			M9*209	10.12	M9*742	10.17	TM1	12.9
CTI6040NM	12.9			M9*211	10.12	M9*743	10.17	TM100S4	12.9
CTI8040BW	12.8			M9*215	10.12	M9*744	10.17	TM101SS2	12.9
CTI8040N	12.8			M9*230	10.8	M9*745	10.17	TM102	12.9
CTM4018N	12.8			M9*231	10.8	M9*810	10.11	TM2	12.9
CTM4018NMK	12.9			M9*232	10.8	M9*811	10.11	TM4	12.9
CTM4P18NMK	12.9			M9*233	10.8	M9*812	10.11	X9905753	15.45
CTM5018NMK	12.9			M9*234	10.8	M9*813	10.11	X9905754	15.45
CTM5P18N	12.8			M9*235	10.8	M9*814	10.11	X9908359	15.45
CTM8018N	12.8			M9*236	10.8				
CTM8018NMK	12.9			M9*237	10.8				
CTS10P50NMK	12.9			M9*238	10.8				
CTS1150BW	12.8			M9*240	10.8				
CTS1150N	12.8			M9*241	10.8				
CTS11P50NM	12.9			M9*242	10.8				
CTS14P50BW	12.8			M9*243	10.8				
CTS14P50N	12.8			M9*244	10.8				
CTS14P50NM	12.9			M9*245	10.8				
CTS17P50BW	12.8			M9*246	10.8				
CTS17P50N	12.8			M9*247	10.8				
CTS8050BW	12.8			M9*248	10.8				
CTS8050N	12.8			M9*381T	10.13				
CTS8050NMK	12.9			M9*382T	10.13				
HCCT	21.26			M9*384T	10.13				
HCST	21.26			M9*386T	10.13				
I100255	10.18, 16.34, 18.12			M9*389T	10.13				
I100266	10.18, 16.34, 18.12			M9*391T	10.13				
I100455	10.18, 16.34, 18.12			M9*393T	10.13				
I100466	10.18, 16.34, 18.12			M9*398T	10.13				
I100655	10.18, 16.34, 18.12			M9*400T	10.13				
I100666	10.18, 16.34, 18.12			M9*500T	10.11				
I400855	10.18, 16.34, 18.12			M9*502T	10.11				
I400866	10.18, 16.34, 18.12			M9*505T	10.11				
I601255	10.18, 16.34, 18.12			M9*507T	10.11				
I601266	10.18, 16.34, 18.12			M9*509T	10.11				
I601855	10.18, 16.34, 18.12			M9*510T	10.11				
I601866	10.18, 16.34, 18.12			M9*511T	10.11				
I602455	10.18, 16.34, 18.12			M9*513T	10.11				
I602466	10.18, 16.34, 18.12			M9*520T	10.11				
I603655	10.18, 16.34, 18.12			M9*601	10.5				
I603666	10.18, 16.34, 18.12			M9*602	10.5				
I604855	10.18, 16.34, 18.12			M9*604	10.5				
I604866	10.18, 16.34, 18.12			M9*606	10.5				
I606055	10.18, 16.34, 18.12			M9*609	10.5				
I606066	10.18, 16.34, 18.12			M9*611	10.5				
I607255	10.18, 16.34, 18.12			M9*612	10.5				
I607266	10.18, 16.34, 18.12			M9*614	10.5				
M96551	10.9			M9*112	10.5				
M96566	10.9			M9*114	10.5				
M96567	10.9			M9*116	10.5				
M96568	10.9			M9*120	10.5				
M96569	10.9			M9*130	10.7				
M96570	10.9			M9*131	10.7				
M96571	10.9			M9*132	10.7				
M96572	10.9			M9*133	10.7				
M96573	10.9			M9*134	10.7				
M96574	10.9			M9*135	10.7				
M96575	10.9			M9*136	10.7				
M96639	10.9			M9*137	10.7				
M96780	10.5			M9*138	10.7				
M96908	10.5			M9*150	10.15				
M96909	10.5			M9*151	10.15				
M96915	10.3			M9*152	10.15				
M96919	10.3			M9*153	10.15				
M96963	10.5			M9*154	10.15				
M96992	10.5			M9*155	10.15				
M97041	10.5			M9*170	10.15				
M97112	10.3			M9*171	10.15				
M97174	10.5			M9*172	10.15				
M97219	10.5			M9*173	10.15				
M97411	10.5			M9*174	10.15				
M97412	10.5			M9*175	10.15				
M98086	10.3			M9*202	10.12				
M9A001	10.3			M9*204	10.12				
M9A002	10.3			M9*205	10.12				
M9A003	10.3			M9*206	10.12				
M9A004	10.3			M9*207	10.12				
M9A005	10.7			M9*209	10.12				
M9A006	10.7			M9*211	10.12				
M9A007	10.7			M9*215	10.12				
M9A008	10.7			M9*230	10.8				
M9A009	10.7			M9*231	10.8				
M9A010	10.7			M9*232	10.8				
M9A011	10.7			M9*233	10.8				
M9A012	10.7			M9*234	10.8				
M9A013	10.7			M9*235	10.8				
M9A014	10.7			M9*236	10.8				
M9A015	10.7			M9*237	10.8				
M9A016	10.7			M9*238	10.8				
M9A017	10.7			M9*240	10.8				
M9A018	10.7			M9*241	10.8				
M9A019	10.7			M9*242	10.8				
M9A020	10.7			M9*243	10.8				
M9A037	10.5			M9*244	10.8				
M9A038	10.5			M9*245	10.8				
M9A039	10.5			M9*246	10.8				
M9A040	10.5			M9*247	10.8				
M9A042	10.5			M9*248	10.8				
M9A043	10.5			M9*381T	10.13				
M9A044	10.5			M9*382T	10.13				
M9A045	10.5			M9*384T	10.13				
M9A046	10.5			M9*386T	10.13				
M9A048	10.5			M9*389T	10.13				
M9A082	10.7			M9*391T	10.13				
M9A083	10.7			M9*393T	10.13				
M9A100	10.5			M9*398T	10.13				
M9A101	10.5			M9*400T	10.13				
M9A102	10.5			M9*500T	10.11				
M9A103	10.5			M9*502T	10.11				
M9A104	10.5			M9*505T	10.11				
M9A105	10.5			M9*507T	10.11				
M9A107	10.5			M9*509T	10.11				
M9A111	10.5			M9*510T	10.11				
M9A112	10.5			M9*511T	10.11				
M9A114	10.5			M9*513T	10.11				
M9A116	10.5			M9*520T	10.11				
M9A120	10.5			M9*601	10.5				
M9A130	10.7			M9*602	10.5				
M9A131	10.7			M9*604	10.5				
M9A132	10.7			M9*606	10.5				
M9A133	10.7			M9*609	10.5				
M9A134	10.7			M9*611	10.5				
M9A135	10.7			M9*612	10.5				



Belden® Customer Care

Belden has maintained its leadership role in the industry primarily because of the emphasis we place on customers' needs. By staying close to the customer, the various markets we serve and the applicable industry standards, Belden has always been able to meet or exceed the expectations of all.

For All Your Signal Transmission Needs... Be Sure To Specify Belden

Customer-Centric Design™ (CCD) is the phrase we've coined for our product development process, which encompasses so much more than the act of designing a product for a customer. It really means constant care – taking care to stay at the top of our craft in every way imaginable. From the time that a customer's need is established to the end of the product or system's life cycle, Belden provides ongoing support at all times.

Customer-Centric Design Offers Tangible Rewards

When our customers are teamed with our skilled engineering and sales staff it's a win-win opportunity for everyone. This combined effort typically provides our customers with:

- Expertise in technical problem solving
- Innovative designs to match specific applications
- Enhanced performance
- Cost-effective solutions

Raising the Bar on Customer Satisfaction

As we go forward, we recognize that our customers' needs will continue to evolve. We're committed to evolving with them by taking our solutions provider status a step further.

We are extending our Customer-Centric design capabilities to all aspects of signal transmission technology - applying our service support and technical know-how to this decidedly broader sphere.

Evidence of our expanded scope is apparent by our addition of new copper and optical fiber cabling products and systems, end-to-end structured cabling systems, enclosures and racks, Power over Ethernet (PoE) equipment, cable management accessories – and we are not through.

So, whether you need a standard signal transmission product, a modification of an existing product, or a custom designed product and system for your application, just ask.

Belden is
Fully Committed
to Your Needs.



U.S. Customer Service: 800-BELDEN-1 (800-235-3361)**UNITED STATES****Division Headquarters—Americas**

2200 U.S. Highway 27 South
Richmond, IN 47374

Phone: 765-983-5200
Inside Sales: 800-235-3361
Fax: 765-983-5294
info@belden.com
web: www.belden.com

793 Fort Mill Highway
Fort Mill, SC 29715
Phone: 800-331-0779
Fax: 803-802-1440
info@belden.com

ASIA/PACIFIC**Australia**

Level 10
369 Royal Parade
Parkville, Victoria 3052
Australia
Phone: 613-9341-0900
Fax: 613-9347-8274
australia.sales@belden.com

Beijing

Rm 1015
Office Tower Beijing Capital
Times Square
No. 88 West Changan Ave.
Beijing 100031
People's Republic of China
Phone: 8610-8391-5181-3
Fax: 8610-8391-5186
hongkong.sales@belden.com

Hong Kong

Unit 4401, 44F
Cosco Tower
Grand Millennium Plaza
183 Queen's Road Central
Hong Kong
Phone: 852-2955-0128
Fax: 852-2907-6933
hongkong.sales@belden.com

India

Suite 203, Enkay Towers
Udyog Vihar Phase V
Gurgaon 122016
NCR, India
Phone: +91-124-401-4739
Fax: +91-124-401-4740
india.sales@belden.com

Shanghai

Unit 2605
Harbour Ring Plaza
18 Xi Zang Zhong Road
Shanghai 200001
People's Republic of China
Phone: 8621-5385-3355
Fax: 8621-6249-0879
hongkong.sales@belden.com

Singapore

101 Thomson Road
#21-01 United Square
Singapore 307591
Phone: 65-6251-8211
Fax: 65-6251-5010
singapore.sales@belden.com

CANADA**Cobourg**

130 Willmott Street
Cobourg, Ontario K9A 4M3
Canada
Phone: 905-372-8713
Fax: 905-372-6291
salescobourg@belden.com

Montreal

2345 Boulevard des Sources
Pointe Claire, Quebec
Canada H9R 5Z3
Phone: 800-681-6131
Fax: 514-822-7968
ibdn.info@belden.com

EUROPE/AFRICA/MIDDLE EAST**France**

Immeuble le Cesar
20, Place Louis Pradel
69001 Lyon
France
Phone: 33-472-109-990
Fax: 33-478-298-409
venlo.salesinfo@belden.com

Italy

Via Paracelso, 26
Centro Direzionale Colleoni
Palazzo Cassiopea Ingr. 3
20041 Agrate Brianza (MI)
Italy
Phone: 39 039 656 0911
Fax: 39 029 656 0929
venlo.salesinfo@belden.com

Africa/Middle East

P.O. Box #500158
Dubai Internet City
Building One, Office 216
Dubai
United Arab Emirates
Phone: 97-14-391-0490
Fax: 97-14-391-8775
sales@belden.ae

The Netherlands

Division Headquarters – Europe
Edisonstraat 9, Postus 9
5928 PG Venlo, 5900 AA
The Netherlands
Phone: 31-773-878-555
Fax: 31-773-878-448
venlo.salesinfo@belden.com

United Kingdom

3000 Manchester Business Park
Aviator Way
Manchester M22 5TG
United Kingdom
Phone: +44-161-266-1115
Fax: +44-161-266-1339
venlo.salesinfo@belden.com

MEXICO/CARIBBEAN/SOUTH AMERICA**Regional Office**

6100 Hollywood Boulevard
Suite 110
Hollywood, Florida 33024
Phone: 954-987-5044
Fax: 954-987-8022
salesla@belden.com

Mexico

Insurgentes Sur 800, Piso 9
Colonia del Valle
03100 Mexico, D.F.
Mexico
Phone: 5255-5523-7733
Fax: 5255-5528-8077
salesmex@belden.com

South America

Rua dos Pinheiros, 245,
Conjunto 2
Pinheiros
05422-010 Sao Paulo, SP Brasil
Phone: 5511-3061-3099
Fax: 5511-3061-3752
salesBRZL@belden.com